

Heating-Controller HCC 5

Weather controlled heat circuit regulator

Installation and operating instructions



Read carefully before installation, commissioning and operation

Content

	page		page
A.1	3	5.	21
A.2	3	5.1	21
A.3	3	5.2	21
A.4	4	5.3	22
A.5	4	5.4	23
		5.5	23
B.1	5	5.6	23
B.2	5	5.7	24
B.3	6	5.8	24
B.4	6	6. DHW settings	25
B.5	6	6.1	25
B.6	7	6.2	25
		6.3	25
C.1	8	6.4	25
C.2	9	6.5	25
C.3	10	7. Protective functions	26
C.4	10	7.1	26
		7.2	26
D	11	7.3	26
		7.4	27
E.1	12	7.5	27
E.2	13	7.6	27
E.3	13	8. Special functions	28
E.4	14	8.1	28
		8.2	28
1.	15	8.3	28
		8.4	29
2.	16	8.5	29
2.1	16	8.6	30
2.2	16	9. Menu lock	31
2.3	16	11. Language	31
2.4	16	10. Service values	32
2.5	16	Z.1. Malfunctions with error messages	33
2.6	16	Z.2 Replacing the fuse	34
2.7	16	Z.3 Maintenance	34
3.	17		
3.1	17		
3.2	17		
3.3	17		
3.4	18		
4.	19		
4.1	19		
4.2	20		
4.3	20		
4.4	20		
4.5	20		

Safety instructions

A.1 EC declaration of conformity

By affixing the CE mark to the unit the manufacturer declares that the HCC 5 conforms to the following relevant safety regulations:

- EC low voltage directive 2006/95/EC
- EC electromagnetic compatibility directive 2004/108/EC

Conformity has been verified and the corresponding documentation and the EC declaration of conformity are kept on file by the manufacturer.

A.2 General instructions

It is essential that you read this!

These installation and operating instructions contain basic instructions and important information regarding safety, installation, commissioning, maintenance and the optimal use of the unit. Therefore these instructions must be read completely and understood by the installation technician/ specialist and by the system user before installation, commissioning and operation of the unit.

The valid accident prevention regulations, VDE regulations, the regulations of the local power utility, the applicable DIN-EN standards and the installation and operating instruction of the additional system components must also be observed. The controller does not under any circumstances replace any safety devices to be provided by the customer!

Installation, electrical connection, commissioning and maintenance of the unit may only be carried out by specialists who possess the appropriate training.

For the user: Make sure that the specialist gives you detailed information on the function and operation of the controller. Always keep these instructions in the vicinity of the controller.

A.3 Explanation of symbols



Failure to observe these instructions can result in danger to life from electric voltage.



Failure to observe these instructions can result in serious damage to health such as scalding, or even life-threatening injuries.



Failure to observe these instructions can result in destruction of the unit or the system, or damage to the environment.



Information which is especially important for the function and optimal use of the unit and the system.

Safety instructions

A.4 Changes to the unit



Changes to the unit can compromise the safety and function of the unit or the entire system.

- Changes, additions to or conversion of the unit are not permitted without written permission from the manufacturer
- It is likewise forbidden to install additional components that have not been tested together with the unit
- If it becomes clear that safe operation of the unit is no longer possible, for example because of damage to the housing, then turn the controller off immediately
- Any parts of the unit or accessories that are not in perfect condition must be exchanged immediately
- Use only original spare parts and accessories from the manufacturer.
- Markings made on the unit at the factory must not be altered, removed or made illegible
- Only the settings actually described in these instructions may be made on the controller

A.5 Warranty and liability

The controller has been manufactured and tested with regard to high quality and safety requirements. The unit is subject to the statutory guarantee period of two years from the date of sale.

The warranty and liability shall not include, however, any injury to persons or material damage that is attributable to one or more of the following causes:

- Failure to observe these installation and operating instructions
- Improper installation, commissioning, maintenance and operation
- Improperly executed repairs
- Unauthorised structural changes to the unit
- Installation of additional components that have not been tested together with the unit
- Any damage resulting from continued use of the unit despite an obvious defect
- Failure to use original spare parts and accessories
- Use of the device for other than its intended purpose
- Operation above or below the limit values listed in the specifications
- Force majeure

Description of controller

B.1 Specifications

Electrical specifications:

Mains Voltage	230VAC +/- 10%
Mains frequency	50...60Hz
Power consumption	2VA
Total switched power	460VA (Relay outputs 1-3)
Switched power per relay	460VA for AC1 / 185W for AC3
Internal fuse	2A slow blow 250V
Protection category	IP40
Protection class	II
Sensor inputs	5x Pt1000 temperature sensor 1x Room
Measuring range	-40 to 110°C

Permissible ambient conditions:

Ambient temperature	
for controller operation	0°C...40°C
for transport/storage	0°C...60°C
Air humidity	
for controller operation	max. 85% humidity at 25°C
for transport/storage	no moisture condensation permitted

Other specifications and dimensions

Housing design	2-part, ABS plastic
Installation methods	Wall installation, optionally panel installation
Overall dimensions	163mm x 110mm x 52mm
Aperture installation dimensions	157mm x 106mm x 31mm
Display	Fully graphical display 128 x 64 dots
Light diode	Multicolour
Operation	4 entry keys

Temperature sensors:

	(may not be included in the scope of supply)
Immersion sensor	Pt1000, e.g. immersion sensor TT/P4
Pipe-mounted sensor	Pt1000, e.g. pipe-mounted sensor TR/P4
Outdoor sensor	Pt1000, e.g. outdoor sensor TA52
Remote adjuster	Pt1000, Typ RC21
Sensor leads	2x0.75mm ² extendable up to 30m

B.2 Temperature resistance table for Pt1000 sensors

°C	0	10	20	30	40	50	60	70	80	90	100
Ω	1000	1039	1077	1116	1155	1194	1232	1270	1308	1347	1385

Description of controller

B.3 About the controller

The weather controlled Heat Circuit Controller HCC 5 facilitates efficient use and function control of your heating system. The device is impressive most of all for its functionality and simple, almost self-explanatory operation. For each step in the input process the individual entry keys are assigned to appropriate functions and explained. The controller menu contains headwords for the measured values and settings, as well as help texts or clearly-structured graphics.

Important characteristics of the HCC 5:

- Depiction of graphics and texts in a lighted display
- Simple viewing of the current measurement values
- Statistics and monitoring of the system by means of statistical graphics, etc.
- Extensive setting menus with explanations
- Menu block can be activated to prevent unintentional setting changes
- Resetting to previously selected values or factory settings
- various additional functions are available e.g. 0...10V connection for boiler control

B.4 Scope of supply

- Heating controller HCC 5
- 3 screws 3,5x35mm and 3 plugs 6mm for wall installation
- 6 strain reliefs with 12 screws, replacement fuse 2AT
- installation and operating instructions HCC 5

Optionally contained depending on design/order:

- 1x outdoor sensor e.g. TA52 (Pt1000)
- 1-2x pipe-mounted sensor e.g. TR/P4 (Pt1000)
- 1x buffer sensor e.g. TT/P4 (Pt1000)
- 1x Indoor sensor/remote adjuster with mode switch RC21
- 1x Immersion sleeve e.g. TH150
- various additional functions expansion boards

B.5 Disposal and pollutants

The unit conforms to the European RoHS directive 2002/95/EC for the restriction of the use of certain hazardous substances in electrical and electronic equipment.



The unit must not under any circumstances be disposed of with ordinary household refuse. Dispose of the unit only at appropriate collection points or ship it back to the seller or manufacturer.

Description of controller

B.6 Hydraulic variants



Caution

The following illustrations should be viewed only as schematic diagrams showing the respective hydraulic systems, and do not claim to be complete. The controller does not replace safety devices under any circumstances. Depending on the specific application, additional system components and safety components may be mandatory, such as check valves, non-return valves, safety temperature limiters, scalding protectors, etc., and must therefore be provided.

① Mixed heat circuit with buffer

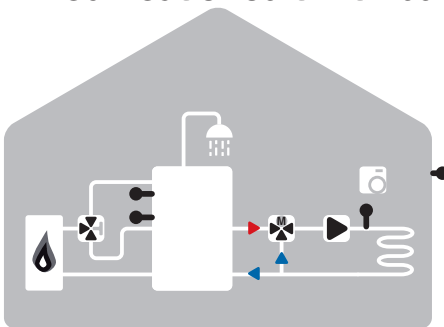

② Mixed heat circuit with buffer and domestic hot water buffer

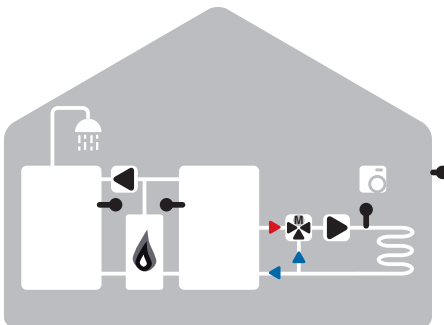

③ Mixed heat circuit and domestic hot water buffer

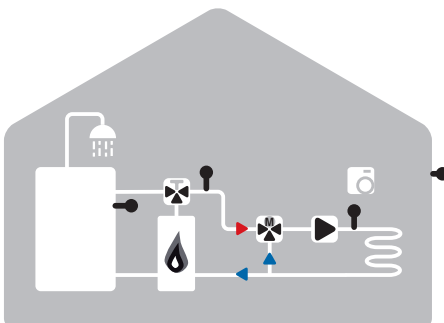

Caution

In heating installations where domestic hot water is not needed, the DHW heating can be deactivated in menu 4 „Operating mode“.
In heating installations without buffer the buffer sensor has to be installed in an appropriate position ahead of the mixer.

Installation

C.1 Wall installation



Install the controller only in dry areas and under the ambient conditions described under B.1 „Specifications“. Carry out the following steps 1-8.

C.1.1

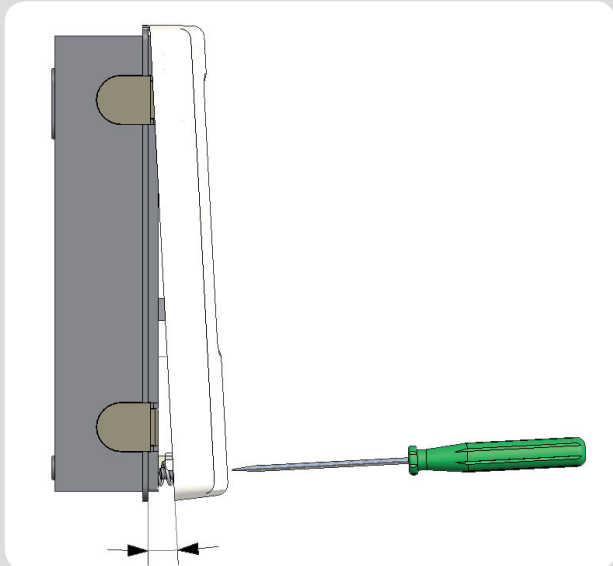

1. Unscrew cover screw completely
2. Carefully pull upper part of housing from lower part.
3. Set upper part of housing aside, being sure not to touch the electronics when doing so.
4. Hold the lower part of the housing up to the selected position and mark the 3 mounting holes. Make sure that the wall surface is as even as possible so that the housing does not become distorted when it is screwed on.

C.1.2

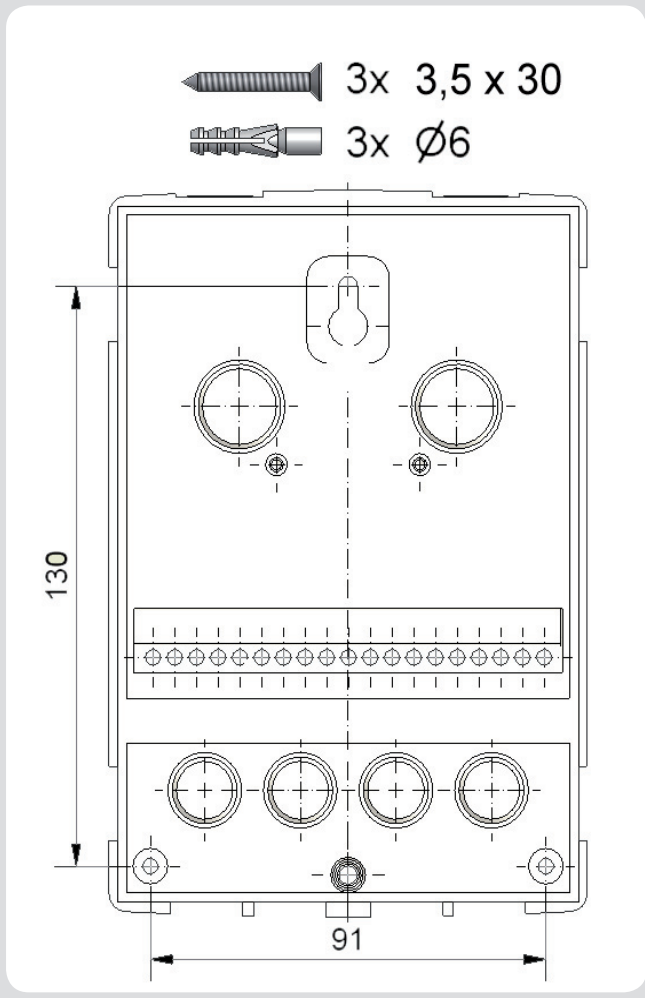

5. Using a drill and size 6 bit, drill 3 holes at the points marked on the wall and push in the plugs.
6. Insert the upper screw and screw it in slightly.
7. Fit the upper part of the housing and insert the other two screws.
8. Align the housing and tighten the three screws.

Installation

C.2 Electrical connection



Before working on the unit, switch off the power supply and secure it against being switched on again!
Check for the absence of power!
Electrical connections may only be made by a specialist and in compliance with the applicable regulations. The controller may not be put into operation if there is visible damage to the housing, e.g. cracks.



Low-voltage cables such as temperature sensor cables must be routed separately from mains voltage cables. Feed temperature sensor cables only into the left-hand side of the unit, and mains voltage cables only into the right-hand side.



The customer must provide an all-pole disconnecting device, e.g. a heating emergency switch.



The cables being connected to the unit must not be stripped by more than 55mm, and the cable jacket must reach into the housing just to the other side of the strain relief.

C.2.1

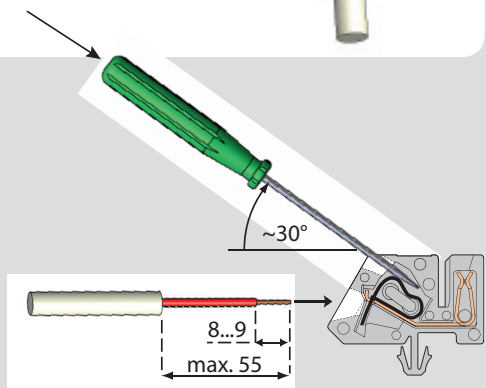
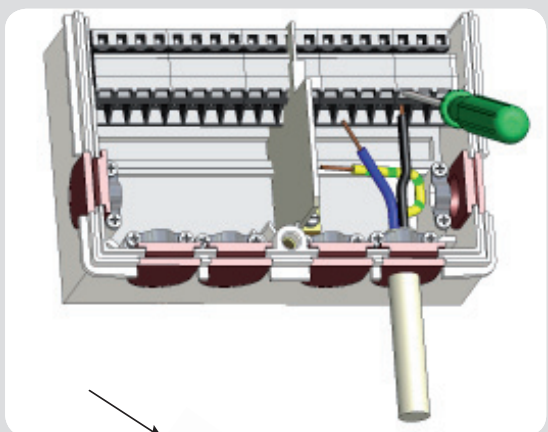

1. Open controller housing (see C.1.1)
2. Strip cables max. 55mm, insert, fit the strain relief devices, strip the last 8-9 mm of the wires. (Fig.C.2.1)
3. Open the terminals using a suitable screwdriver (Fig. C.2.1) and make electrical connections on the controller (see section D)
4. Refit upper part of housing and fasten with screw.
6. Switch on mains voltage and place controller in operation

Installation

C.3 Installing the temperature sensors

Der Regler arbeitet mit Pt1000-Temperaturfühlern, die für eine gradgenaue Temperaturerfassung sorgen, um die Anlagenfunktion regeltechnisch optimal sicherzustellen.



Caution

If desired the sensor cables can be extended to a maximum of 30m using a cable with a cross-section of at least 0.75mm².

Make sure that there is no contact resistance!

Position the sensor precisely in the area to be measured!

Only use immersion, pipe-mounted or fl at-mounted sensor suitable for the specific area of application with the appropriate permissible temperature range.



Caution

The temperature sensor cables must be routed separately from mains voltage cables, and must not, for example, be routed in the same cable duct!



Caution

S6 is by default connected by jumper with the terminal block S- to enable the heating circuit functions. If the jumper is removed, the heating circuit is switched off. When connecting the remote adjuster RC21 the jumper has to be removed. If a third party external thermostat is connected, it's electrical contacts has to be floating and of low resistance = 0 Ohm.

C.4 Installation of the additional functions via clamps Z1/Z2



Caution

The instructions are supplied with the expansion board. The installation has to be commenced accordingly and all warnings have to be observed.

Installation

D Electrical terminals



Caution

Left-hand terminal compartment only for low voltage if max. 12VAC/DC



Danger

Right-hand terminal compartment only for mains voltages of 230VAC 50-60Hz

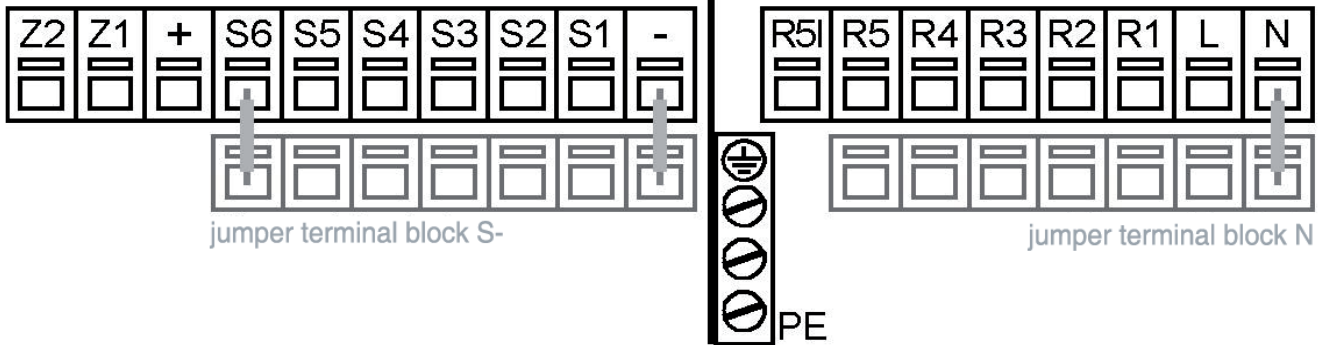

Connections low voltage:

- Temperature sensors S1 - S6 (polarity freely selectable)
- Optional additional functions Z1/Z2

Low voltage max. 12VAC/DC

connection in the left-hand terminal compartment!

Terminal:	Connection for:
-	Jumper terminal block S-
S1	outdoor
S2	heating circuit
S3	Domestic hot water
S4	buffer
S5	indoor sensor
S6	remote adjuster*
+	not used
Z1	Option / add. function
Z2	Option / add. function

Use terminal block S- for connecting the sensor earths of S1-S6.

The polarity of the sensors is freely selectable.

The sensors S4-S6 are optional, depending on the hydraulic variant chosen.

* Note: If the remote adjuster RC21 or a different external floating thermostat is connected, the bridge at S6 has to be removed.

Connections Mains Voltage:

- Protective conductor PE metal terminal block
- Neutral conductor terminal block N
- Mains phase conductor L
- Switch output R1-R4
- Floating contact at R5/R5I

Caution: Only suitable for 230V!

Mains Voltage 230VAC 50-60Hz connection in the right-hand terminal compartment.







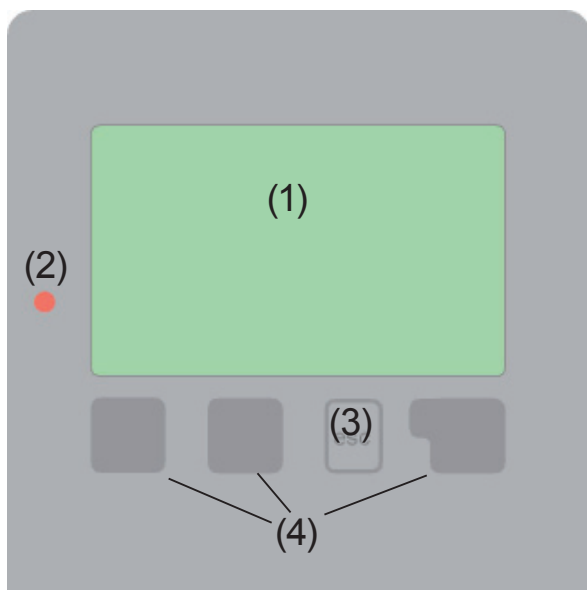







Terminal:	Connection for:
N	Jumper terminal block N
L	Mains phase conductor L
R1	Heat circuit pump
R2	Mixer open
R3	Mixer close
R4	Valve/DHW pump
R5	add. heating
R5I	add. heating

The PE protective conductor must be connected to the PE metal terminal block!

E.1 Display and input



Examples of display symbols:

-  Heating circuit pump
(rotates when active)
-  Heating circuit mixer
(black when active)
-  HC -Day mode (Time progr.)
-  HC-Night mode (Time progr.)
-  HC-Comfort mode (Time progr.)
-  Day mode
-  Night mode
-  Day mode due to RC21
-  Night mode due to RC21
-  Additional heating
-  Reference value mode
-  Reference value 14 day
-  external thermostat off
-  Warning / Error message
-  New information available

The display (1), with its extensive text and graphics mode, is almost self-explanatory, allowing easy operation of the controller.

The LED (2) lights up green when a relay is switched on.

The LED (2) lights up red when operating mode „Off“ is set.

The LED (2) flashes slowly red in the operating mode „Manual“.

The LED (2) flashes quickly red when an error is present.

Entries are made using four keys (3+4), to which different functions are assigned depending on the situation. The „esc“ key (3) is used to cancel an entry or to exit a menu. If applicable there will be a request for confirmation as to whether the changes which have been made should be saved. The function of each of the other three keys (4) is shown in the display line directly above the keys; the right-hand key is generally has a confirmation and selection function.

Examples of key functions:

- +/- = enlarge/shrink values
- ▼/▲ = scroll menu down/up
- yes/no = approve/reject
- Info = additional information
- Back = to previous screen
- ok = confirm selection
- Confirm = confirm setting

Operation

E.2 Commissioning help



The first time the controller is turned on and after the language and time are set, a query appears as to whether you want to parametrise the controller using the commissioning help or not. The commissioning help can also be terminated or called up again at any time in the special functions menu. The commissioning help guides you through the necessary basic settings in the correct order, and provides

brief descriptions of each parameter in the display. Pressing the „esc“ key takes you back to the previous value so you can look at the selected setting again or adjust it if desired. Pressing the „esc“ more than once takes you back step by step to the selection mode, thus cancelling the commissioning help. Finally, menu 4.3 under operating mode „Manual“ should be used to test the switch outputs with the consumers connected, and to check the sensor values for plausibility. Then switch on automatic mode.



Caution

Observe the explanations for the the individual parameters on the following pages, and check whether further settings are necessary for your application.

E.3 Free commissioning

If you decide not to use the commissioning help, you should make the necessary settings in the following sequence:

- Menu 10. Language (see 15.)
- Menu 3. Time, date and operating times (see 8.)
- Menu 5 Settings for heat circuit, all settings (see 10.)
- Menu 6. Protective functions if necessary (see 11.)
- Menu 7. Special functions if necessary (see 13.)

Finally, menu 4.2 under operating mode „Manual“ should be used to test the switch outputs with the consumers connected, and to check the sensor values for plausibility. Then switch on automatic mode.



Caution

Observe the explanations for the the individual parameters on the following pages, and check whether further settings are necessary for your application.

Operation

E.4 Menu sequence and menu structure

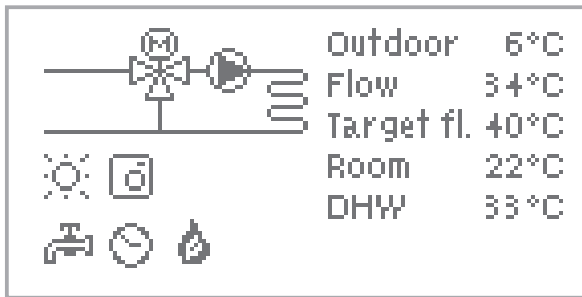

1. Measurements

Current temperature values with explanations

2. Statistics

Function control of the system with operating hours, etc.

3. Times

Operating times for heating circuit and hot water, setting the clock

4. Operating

Operating times for heating circuit and hot water, manual mode

5. HC settings

Set parameters for the heating circuit

6. DHW settings

Set parameters for Domestic Hot Water

7. Protections

Anti-seizing protection, Frost prot., Anti-Legionella activation

8. Special functions

Sensor calibration, Remote adjuster, Mixer, etc.

9. Menu lock

Against unintentional setting changes at critical points

10. Service Data

For diagnosis in the event of an error

11. Language

Selection of the menu language

Measurement values

1. Measurement values



Menu “1. Measurement values” serves to display the currently measured temperatures.

The menu is closed by pressing “esc” or selecting “Exit measurement values”.

Selecting “Info” leads to a brief help text explaining the measurement values.

Selecting “Overview” or “esc” exits the Info mode.



Caution

If “Error” appears on the display instead of the measurement value, then there may be a defective or incorrect temperature sensor.

If the cables are too long or the sensors are not placed optimally, the result may be small deviations in the measurement values. In this case the display values can be compensated for by making entries on the controller.

Follow the instructions under 8.1.

What measurement values are displayed depends on the selected program, the connected sensors and the specific device design.

2. Statistics

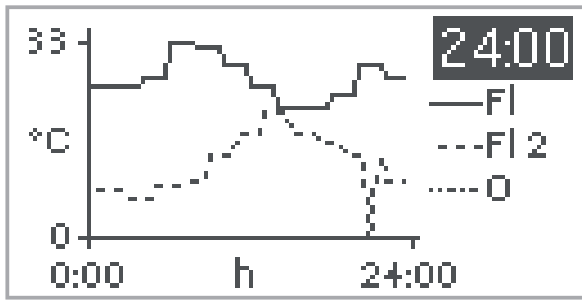

Menu “2. Statistics” is used for function control and long-term monitoring of the system.

The menu is closed by pressing “esc” or selecting “Exit statistics”.



Caution

For system data statistics it is essential for the time to be set accurately on the controller. Please note that the clock continues to run for about 24 hours if the mains voltage is interrupted, and after that has to be reset. Improper operation or an incorrect time may result in data being cleared, recorded incorrectly or overwritten.

The manufacturer accepts no liability for the recorded data!

2.1 Today

Flow temperature for the present day

In the graphical overview the characteristics of outdoor-and flow temperature for the present day is shown from 0-24h. The right button changes the unit of time and the two left buttons scroll through the diagram.

2.2 28-days

Flow temperature during the last 28 days

In the graphical overview the characteristics of the outdoor and flow temperature during the last 28 days is shown. The right button changes the unit of time (Days) and the two left buttons scroll through the diagram.

2.3 Operating hours Heat Circuit

Display of operating hours of the heat pump connected to the controller, and the date the measurement started.

2.4 Operating hours DHW

Display of operating hours of Domestic Hot Water pump connected to the controller, and the date the measurement started.

2.5 Operating hours heating

Display of operating hours of additional heating, and the date the measurement started.

2.6 Error messages

Display of the last three errors in the system with indication of date and time.

2.7 Reset / clear

Resetting and clearing the individual statistics. Selecting “All statistics” clears everything except for the error log.

Times

3. Times

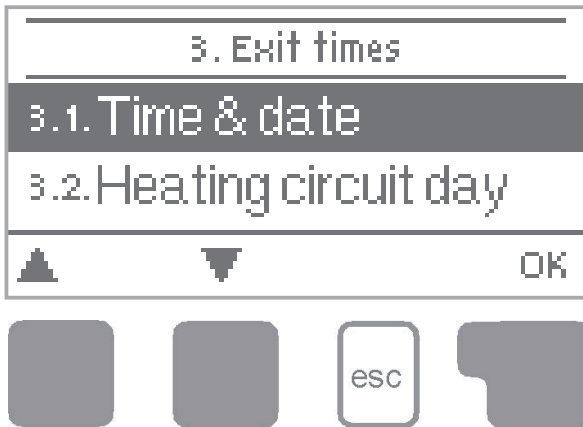

Menu “3. Times” is used to set the time, date, operating times for the heating circuit and hot water.



Caution

The associated temperature reference values are specified in menu 5 “Settings”!

The menu is closed by pressing “esc” or selecting “Exit times”.

3.1 Time & Date

This menu is used to set the current time and date.



Caution

For proper functioning of the controller and statistics for the system data it is essential for the time to be set accurately on the controller. Please note that the clock continues to run for about 24 hours if the mains voltage is interrupted, and after that has to be reset.

3.2 Heating circuit day

This menu is used to select the daytime mode times for the heating circuit; three time periods can be specified for each weekday and copied over to the following days.

Setting range: Three time ranges for each day of the week

Default: Mo-Su 6:00-22:00

Note: See 5. for the associated temperature settings



Caution

Times that are not specified are automatically considered to be night-time mode. The set times are only taken into account in the heating circuit operating mode “Automatic”

3.3 Heating comfort

This menu can be used to select a time range for each day of the week in which the heating circuit is supplied with an increased comfort temperature, e.g. for quick heating in the morning.

Setting range: One time range for each day of the week

Default: Mo-Su off

Note: See 5. for the associated temperature settings.

Times

3.4 Hot water enable

This menu is used to select the times when the domestic hot water heating is enabled (sensor 3); three time periods can be specified for each weekday and copied over to the following days.

Setting range: Three time ranges for each day of the week

Default: Mo-Su 6:00-22:00

Note: See 11. for the associated temperature settings



Caution

Times that are not specified are set to “disabled”.

Operating modes

4. Operating modes

+ Exit operating mode		
+1. Heating circ.	Auto	
+2. Heating circ. 2	off	
▲	▼	Info



Menu “4. Operating modes” is used to specify the operating modes for the heating circuit.

After an interruption of the mains voltage the controller automatically returns to the last operating mode selected! The menu is closed by pressing “esc” or selecting “Exit operating modes”.



Caution

The controller works with the set operating times and the corresponding different reference flow temperature values only in the automatic mode.

4.1 Heat circuit

Auto = Automatic/Normal mode using the set times.

Continuous Day = The set values for day mode are used.

Continuous Night = The set values for night mode are used.

Reference Value = Fixed flow temperature regardless of the outdoor temperature. The desired flow temperature has to be set in menu 4.3.

14 day reference value = Specific fixed flow temperatures can be set for the next 14 days in menu 4.4. After 14 days, the reference temperature of the 14th day is used until the operating mode is changed.

Off = Heating circuit is switched off (except Frost protection)

Settings range: Auto, Continuous day, Continuous night, Reference value, 14 day reference, Off

Default: Automatic

Operating modes

4.2 Manual

In Manual mode the individual relay outputs and the connected consumers can be checked for proper functioning and correct assignment.

Function in manual mode:

The relays and thus the connected consumer are switched on and off by pressing a key, with no regard to the current temperatures and the parameters which have been set.



The operating mode “Manual” may only be used by specialists for brief function tests, e.g. during commissioning!

4.3 Heat circuit reference

If operating mode “Reference value” is selected, (Menu 4.1), the reference flow temperature has to be set here, regardless of the curve/outdoor temperature.

Settings range: 10 °C to 75 °C

Default: 30 °C

4.4 14 day reference

If operating mode “14 day reference value” is selected (Menu 4.1), the reference flow temperature for each of the 14 days can be set here.

In the first menu 4.4.1 the starting time of the program is shown. To start the program, hit restart.

Hitting “restart” again will reset the 14 day reference program and start it at day 1.

4.5 Domestic Hot Water

The domestic hot water heating can be activated here. “Auto” makes use of the times set in the “times” menu (see menu 3.4), “On” activates continuously, and “Off” switches the DHW heating off.

Settings range: Auto, On, Off

Default: Auto

Settings Heating circuit

5. Settings Heating circuit

5. Exit settings	
5.1. S/W day	18°C
5.2. S/W night	12°C

▲ ▼ Info



The necessary basic settings required for the control function of the heating circuit are made in menu “5. Settings HC”.



Caution

This does not under any circumstances replace the safety facilities to be provided by the customer!

The menu is closed by pressing “esc” or selecting “Exit settings”.

5.1 Su/Wi Day

Summer/Winter changeover in daytime mode

If this value is exceeded at outdoor sensor S1 during the daytime mode times, the controller automatically switches the heating circuit off = Summer mode.

If the outdoor temperature drops below this value, the heating circuit is switched on again = Winter mode.

Setting range: from 0°C to 30°C / default setting: 18°C



Caution

In addition to the operating times in normal daytime operation, this setting is also valid for times with activated comfort temperature boost and activated low-rate period boost.

5.2 Su/Wi Night

Summer/Winterchangeover in nighttime mode

If this value is exceeded at outdoor sensor S1 during the nighttime mode times, the controller automatically switches the heating circuit off = Summer mode.

If the outdoor temperature drops below this value, the heating circuit is switched on again = Winter mode.

Settings range: 0°C to 30°C / Default: 12°C

Settings Heating circuit

5.3 Curve

The characteristic curve is used to control the heat dissipation of the heating circuit relative to the outdoor temperature.

The demand for heat is different due to differences in the type of building/insulation/ type of heating/outdoor temperature. For this reason the controller can make use of a normal straight curve (Setting simple) or a split curve (Setting split).

In the simple setting the curve can be adjusted with the help of the graphic diagram. The slope is changed, and the calculated reference flow temperature is displayed for $-12\text{ }^{\circ}\text{C}$.

If the split mode is selected, the characteristic curve is adjusted in 3 steps. First the standard slope has to be set, after that the split point and finally the steepness of the curve after the split. While adjusting the curve the steepness of the slope and the calculated reference flow temperature for $-12\text{ }^{\circ}\text{C}$ outdoor temperature is displayed.

Settings range:

Characteristic curve : simple or split / Default: simple

Slope : 0.0...3.0 / Default: 0.8

Splitpoint at outdoor temp.: $+10\text{ }^{\circ}\text{C}$... $-10\text{ }^{\circ}\text{C}$

Angle: differs, depends on steepness and split point

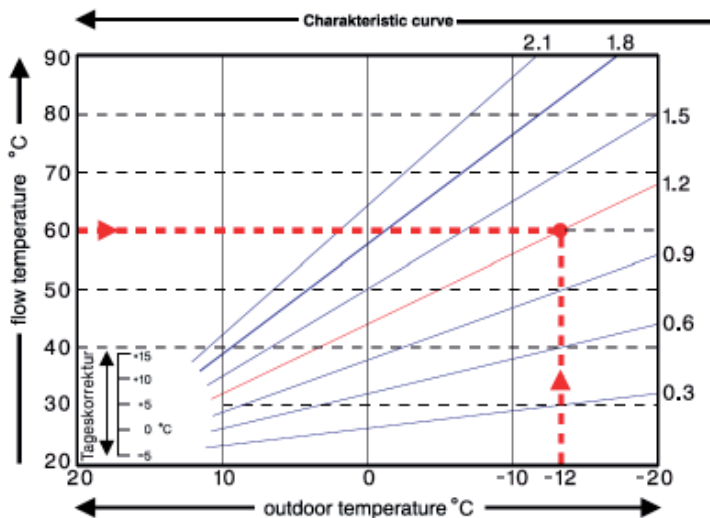

The diagram shows the influence of the selected characteristic curve steepness (standard curve) on the calculated reference flow temperature of the heating circuit. The correct curve is appointed by setting the intersection point of the calculated maximum flow temperature and the minimum outdoor temperature.

Example:

Maximum calculated flow temperature $60\text{ }^{\circ}\text{C}$ at minimum outdoor temperature according to heat demand calculation $-12\text{ }^{\circ}\text{C}$. The intersection results in a slope of 1.2.

Settings Heating circuit



Caution

The following settings can be used for parallel translation of the characteristic for certain time periods such as daytime and nighttime mode.

5.4 Day correction

The day correction produces a parallel translation of the heating characteristic during the daytime operating hours, since depending on the outdoor temperature it is possible that the building may not be optimally heated with the set characteristic. If the characteristic is not optimised, the following situation may occur:

in hot weather - the spaces are too cold

in cold weather - the spaces are too hot

In this case, one should gradually reduce the characteristic slope in steps of 0.2, each time raising the day correction by 2-4 °C.

This procedure can be repeated several times as needed.

Setting range: from -10°C to 50°C / default setting: 5 °C

5.5 Night correction

Parallel translation of the characteristic curve

The night correction produces a parallel translation of the heating characteristic during the nighttime operating hours. If a negative value is set for the night correction, the reference flow temperature is lowered accordingly during the nighttime operating hours. In this manner, primarily at night, but also during the day when no-one is at home, the room temperature is lowered, thus saving energy.

Example: A day correction of +5°C and a night correction of -2°C produces a reference flow temperature in nighttime operation that is 7°C lower.

Setting range: from -30°C to 30°C / default setting: -2°C

5.6 Comfort temperature boost

Parallel translation of the characteristic curve

The comfort temperature boost is added to the set day correction. In this manner it is possible to carry out quick heating and/or a higher temperature in the living spaces at a certain time each day.

Setting range: from 0°C to 15°C / default setting: 0°C = off

Settings Heating circuit

5.7 Reference/actual -

Switch on hysteresis for additional heating

This setting determines the allowed undershoot of the heat circuit temperature under the calculated reference flow temperature. If the heat circuit flow temperature falls below the reference temperature by this value, the additional heating (R5) is activated after a delay of 1 minute.

Settings range: -10°C to 10°C / Default: -2°C



Caution

The additional heating (relais R5) is started when the flow temperature (in case of 2 heat circuits: one of the flow temperatures) is below the reference flow temperature for 5 minutes continuously.

5.8 Reference/actual +

Switch off hysteresis (only if S4 is connected)

This settings determines the allowed overstepping of the heat circuit temperature to the calculated reference flow temperature at sensor 4. If the temperature at S4 exceeds the reference flow temperature by this value, the additional heating (R5) is switched off.

Settings range: 1°C to 10°C / Default: 2°C

DHW settings

6. DHW settings



The necessary basic settings required for the control function of the 2nd heating circuit are made in menu “6. Settings DHW”. The menu is closed by pressing “esc” or selecting “Exit settings”.



Danger

This does not under any circumstances replace the safety facilities to be provided by the customer!

6.1 DHW min

Minimum domestic hot water temperature

If outside the time periods set in the „Times“ menu (see 8.4), i.e. the DHW is disabled, the temperature at the DHW sensor S3 drops below the one set here, the domestic hot water pump (relay 4) and the additional heating (relay 5) is switched on.

Settings range: 10 °C to 60 °C / Default: 45 °C

6.2 DHW reference

Minimum DHW temperature

If the temperature at the DHW sensor S3 drops below the temperature set here and the DHW charging is enabled, the DHW charging (relay R4) and the additional heating (relay R5) are activated.

Settings range: 10 °C to 60 °C / Default: 45 °C

6.3 DHW hysteresis

Hot water hysteresis

The domestic hot water pump (relay R4) and and additional heating (relay R5) is switched off when the temperature at DHW sensor S3 reaches the temperatures set in the menus „DHW min“ and „DHW reference“ plus the temperature difference set here.

Settings range: 2K to 20K / Default: 10K

6.4 Buffer HW load

Charge DHW from the buffer storage

DHW charging via relay R4 directly from the buffer storage is activated when the temperature at buffer sensor S4 is at least 8 °C warmer than the DHW sensor S3. DHW charging is deactivated again when the temperature difference drops to 4 °C or when the temperature at DHW sensor S3 reaches the values set in „DHW min“ and „DHW reference“

Settings range: On, Off / Default: Off

6.5 DHW priority

If this function is active during a DHW heating the reference flow temperature is set to the minimum flow temperature to ensure that the mixer is closed.

Settings range: Yes, No / Default: No

Protective functions

7. Protective functions



Menu “7. Protective functions” can be used by specialists to activate and set various protective functions. The menu is closed by pressing “esc” or selecting “Exit settings”.



Caution

This does not under any circumstances replace the safety facilities to be provided by the customer!

7.1 Anti-seizing protection

If the anti-seizing protection is activated, the controller switches the heat pump and the mixer on/off at 12:00 pm for 5 seconds to prevent seizing of the pump/valve after long periods of inactivation.

Settings range: on, off / Default: on

7.2 Frost protection

Frost protection function can be activated for the heat circuit. If the outdoor temperature at sensor S1 drops below 1 °C and the heat circuit is switched off, the controller switches the heat circuit back on with the reference temperature set in in menu 6.3 (min. flow temperature). As soon as the outdoor temperature exceeds 1°C the heat circuit is switched off again.

Frost protection - settings range: on, off / Default: on



Caution

Switching the frost protection function off or setting the minimum flow temperature too low can lead to severe damage of the system.

7.3 min. flow temperature

The minimum flow temperature is the lower limit for the characteristic curve/slope and as a result of the reference flow temperature of the heat circuit. Additionally, the min. flow temperature is the reference flow temperature for the frost protection.

Settings range: 5°C to 30°C / Default: 15°C

Protective functions

7.4 max. flow

This is used as the upper limit for the reference flow temperature of the heat circuit. Should the heat circuit temperature exceed this value, the heat circuit is switched off until the temperature drops below.

Settings range: 30 °C to 105 °C / Default: 45 °C



For safety, the customer must provide an additional limiting thermostat which is connected to the pumps in series.

7.5 Anti legionella

When the anti legionella function is active, the domestic hot water part at sensor S3 can be heated up to a specific temperature, provided that the energy is sufficient.

AL function - Settings range: On, Off / Default: Off

AL Tset - Settings range: 60 °C to 80 °C / Default: 70 °C

AL residence time settings range: 1 to 120°C / Default: 60°C

AL heat: The last time the AL function completed successfully.

Times settings range: 0 - 24, Monday to Sunday / Default: 3-5 o'clock



During the anti-Legionella function the storage tank is heated up to high temperatures which can lead to scalding and damage to the system.



The AL function is switched off by default. After the hot water part has been heated, date and time are shown in the menu „7.5.4 AL Heat“.



This anti-Legionella function does not provide complete protection against Legionella, because the controller is dependent on sufficient energy being fed in, and it is not possible to monitor the temperatures in the entire range of the storage tanks and the connected piping system. To provide complete protection against Legionella bacteria, it must be ensured that the temperature is raised to the necessary temperature, and at the same time there must be water circulation in the storage tank and piping system by means of other additional energy sources and control units.

7.6 Discharge protection

To prevent unnecessary cool down of the system, the heating circuit is switched off when the buffer temperature drops below reference temperature.

Settings range: On, Off / Default: Off

Special functions

8. Special functions



Menu “8. Special functions” is used to set basic items and expanded functions.

The menu is closed by pressing “esc” or selecting “Exit special functions”.



The settings in this menu should only be made by a specialist.

8.1 Sensor calibration

Deviations in the temperature values displayed, for example due to cables which are too long or sensors which are not positioned optimally, can be compensated for manually here. The settings can be made for each individual sensor in steps of 0.5°C.

Offset S1...S6 per settings range : -10°C...+10°C Default : 0°C



Caution

Settings are only necessary in special cases at the time of initial commissioning by the specialist. Incorrect measurement values can lead to unpredictable errors.

8.2 Commissioning

Starting the commissioning help guides you in the correct order through the basic settings necessary for commissioning, and provides brief descriptions of each parameter in the display. Pressing the “esc” key takes you back to the previous value so you can look at the selected setting again or adjust it if desired. Pressing the “esc” more than once takes you back to the selection mode, thus cancelling the commissioning help. (see also E.1)



Caution

May only be started by a specialist during commissioning! Observe the explanations for the individual parameters in these instructions, and check whether further settings are necessary for your application.

8.3 Factory settings

All of the settings that have been made can be reset, thus returning the controller to its delivery state.



Caution

The entire parametrisation, statistics, etc. of the controller will be lost irrevocably. The controller must then be commissioned once again.

Special functions

8.4 Expansions

This menu can only be selected and used if additional options or expansion modules have been built into the controller. The associated supplementary installation, mounting and operation instructions are then included with the specific expansion.

8.5 Mixer

8.5.1 Turn time

The mixer is switched on i.e. is opening or closing for the timespan set here, then the temperature is measured to control the flow temperature.

Settings range: 0.5 sec to 3 sec. / Default: 2 sec.

8.5.2 Pause-Factor

The calculated pause time of the mixer is multiplied with the value set here. If the pause factor is “1”, the normal pause time is used, “0.5” will use half the normal pause time, “4” would quadruple the pause time.

Settings range: 0.1 to 4.0 / Default: 1.0

8.5.3 Increase

If the temperature rises very fast, this value is added to the measured flow temperature so that the mixer’s reaction is stronger.

If the measured temperature does not rise any more, the measured value is used again. The measurement occurs once every minute.

Settings range: 0 to 20 / Default: 8



Caution

Settings are only necessary at the time of initial commissioning by the specialist. Incorrect measurement values can lead to severe unpredictable errors.

Special functions

8.6 Room controller

The settings necessary for the optional room controller RC21 are made in this menu. The 3 modes “continuous day”, “continuous night” and “Time controlled/automatic” can be switched at the RC21.

Additionally the reference temperature of the flow can be parallel translated by turning the control wheel. If the wheel is set to minimum, only the minum values that can be set in the protective functions menu will be used.

8.6.1 Room controller

This value is used to appoint the amount of influence in percent the room temperature has on the reference flow temperature. For every degree of deviation of the room temperature from the reference room temperature the percentage of the calculated reference flow temperature set here is added to or, respectively, subtracted from the reference flow temperature. As long as it is within the limits of the min. and max. flow temperatures that can be set in the protective functions.

Example: Reference roomtemp.: e.g. 25 °C ; room temp.: e.g. 20 °C = 5 °C deviation.
calculated reference temp.: e.g. 40 °C : room controller: 10 % = 4 °C

5 X 4 °C = 20 °C According to this 20 °C are added to the reference flow temperature, resulting in 60 °C. If the value is higher than the one set in max. flow temp-, the resulting temperature is only the one set in max. flow temp.

Settings range: 0 % to 20 % / Default: 0

8.6.2 Room reference day

The desired room temperature for day mode. As long as this temperature is not reached, the reference flow temperature is raised or respectively lowered according to the percent setting in “room controller”. If “room controller” is set to 0%, this function is deactivated.

Settings range: 10 °C to 30 °C / Default: 20 °C

8.6.3 Room reference night

The desired room temperature for night mode. As long as this temperature is not reached, the reference flow temperature is raised or respectively lowered according to the percent setting in “room controller”. If “room controller” is set to 0%, this function is deactivated.

Settings range: 10 °C to 30 °C / Default: 20 °C



Caution

In the operating modes “Reference value” and “14day ref.” the remote adjuster is without function.

Menu lock

9. Menu lock



Menu “9. Menu lock” can be used to secure the controller against unintentional changing and compromise of basic functions.

The menu is closed by pressing “esc” or selecting “Exit menu lock”.

The menus listed below remain completely accessible despite the menu lock being activated, and can be used to make adjustments if necessary:

1. Measurement values
2. Statistics
3. Times
8. Menu lock
9. Service values

To block the other menus, select “Menu lock on”.

To enable the menus again, select “Menu lock off”.

Setting range: on, off / default setting: off

Language

11. Language



Menu “11. Language” can be used to select the language for the menu guidance. This is queried automatically during initial commissioning. The choice of languages may differ, however, depending on the device design. Language selection is not available in every device design!

Service values

10. Service values

```

10.1. HCC5 2010/07/13.7443
10.2.Outdoor      6°C
10.3.Flow        49°C
  
```



Menu “10. Service values” can be used for remote diagnosis by a specialist or the manufacturer in the event of an error, etc.



Caution

Enter the values at the time when the error occurs into the table.

The menu can be closed at any time by pressing “esc”.

9.1		9.31		9.61	
9.2		9.32		9.62	
9.3		9.33		9.63	
9.4		9.34		9.64	
9.5		9.35		9.65	
9.6		9.36		9.66	
9.7		9.37		9.67	
9.8		9.38		9.68	
9.9		9.39		9.69	
9.10		9.40		9.70	
9.11		9.41		9.71	
9.12		9.42		9.72	
9.13		9.43		9.73	
9.14		9.44		9.74	
9.15		9.45		9.75	
9.16		9.46		9.76	
9.17		9.47		9.77	
9.18		9.48		9.78	
9.19		9.49		9.79	
9.20		9.50		9.80	
9.21		9.51		9.81	
9.22		9.52		9.82	
9.23		9.53		9.83	
9.24		9.54		9.84	
9.25		9.55		9.85	
9.26		9.56		9.86	
9.27		9.57		9.87	
9.28		9.58		9.88	
9.29		9.59		9.89	
9.30		9.60		9.90	

Malfunctions

Z.1. Malfunctions with error messages

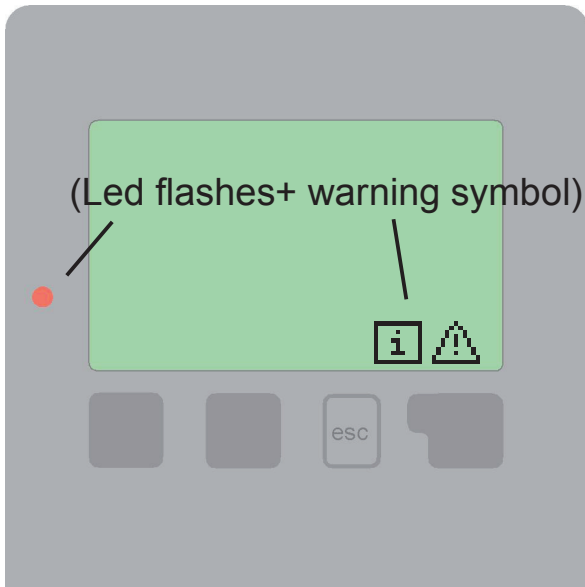

If the controller detects a malfunction, the red light flashes and the warning symbol also appears in the display. If the error is no longer present, the warning symbol changes to an info symbol and the red light no longer flashes. To obtain more detailed information on the error, press the key under the warning or info symbol.



Do not try to deal with this yourself. Consult a specialist in the event of an error!

Possible error / information messages:	Notes for the specialist:
Sensor x defective	Means that either the sensor, the sensor input at the controller or the connecting cable is/was defective. (Resistance table on page 5)
Restart (Information only)	Means that the controller was restarted, for example due to a power failure. Check the date&time!

Malfunctions

Z.2 Replacing the fuse



Repairs and maintenance may only be performed by a specialist. Before working on the unit, switch off the power supply and secure it against being switched on again! Check for the absence of power!



Only use the supplied spare fuse or a fuse of the same design with the following specifications: T2A 250V

Z.2.1

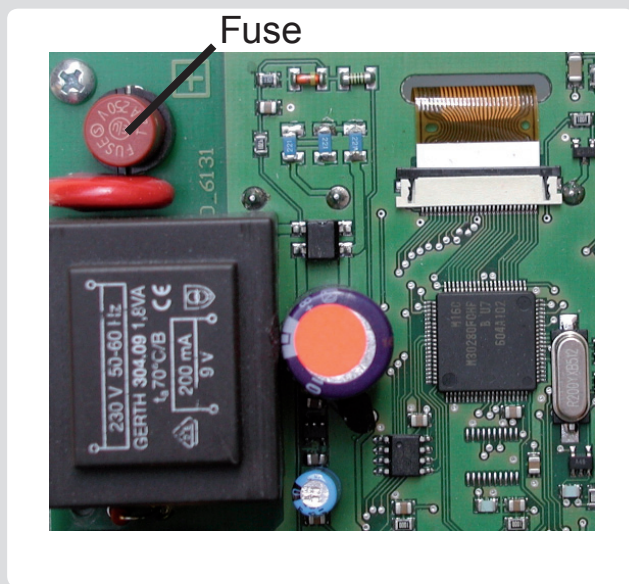

If the mains voltage is switched on and the controller still does not function or display anything, then the internal device fuse may be defective. In that case, open the device as described under C.1, remove the old fuse and check it.

Exchange the defective fuse for a new one, locate the external source of the error (e.g. pump) and exchange it. Then first recommission the controller and check the function of the switch outputs in manual mode as described under 4.2.

Z.3 Maintenance



Caution

In the course of the general annual maintenance of your heating system you should also have the functions of the controller checked by a specialist and have the settings optimised if necessary.

Performing maintenance:

- Check the date and time
- Assess/check plausibility of statistics (see 2.)
- Check the error memory (see 2.6)
- Verify/check plausibility of the current measurement values (see 1.)
- Check the switch outputs/consumers in manual mode (see 4.2)
- Possibly optimise the parameter settings

Useful notes / tips and tricks



The service values (see 10.) include not only current measurement values and operating states, but also all of the settings for the controller. Write the service values down just once after commissioning has been successfully completed.



In the event of uncertainty as to the control response or malfunctions the service values are a proven and successful method for remote diagnosis. Write the service values down (see 10.) at the time that the suspected malfunction occurs. Send the service value table by fax or e-mail with a brief description of the error to the specialist or manufacturer.



To protect against loss of data, record any statistics and data that are particularly important to you (see 2.) at regular intervals.

Hydraulic variant set:

Commissioned on:

Commissioned by:

Final declaration:

Although these instructions have been created with the greatest possible care, the possibility of incorrect or incomplete information cannot be excluded. Subject as a basic principle to errors and technical changes.

Manufacturer:

SOREL GmbH Mikroelektronik

Jahnstr. 36

D - 45549 Sprockhövel

Tel. +49 (0)2339 6024

Fax +49 (0)2339 6025

www.sorel.de info@sorel.de

Your specialist dealer: