



WALL HUNG ELECTRIC BOILER
ATTACK[®]
ELECTRIC EASY



INSTRUCTIONS FOR USE



WWW.ATTACK.SK

Contents

1.1. General information

1.1 Description and use	3
1.2 Advantages of boiler	3
1.3 Important directions and advises	3
1.3.1 Mounting	3
1.3.2 Putting into operation.....	4
1.3.3 Boiler operation.....	4
1.3.4 Safety.....	4
1.4 Main dimensions	5
1.5 Technical data	6
1.6 Main parts	7
1.7 Description of functions	8
1.7.1 Technical description.....	8
1.7.2 Principle of boiler operation.....	8
1.7.3 Control unit and control panell.....	8
1.7.4 Protection function of boiler.....	8
1.7.5 Safety function of boiler.....	8
1.8 Circuit diagram	9

2. 1. Boiler attendance

2.1 Control panel	10
2.2 Switch on/off	10
2.3 Operation modes	10
2.3.1 Operation mode heating (heating water).....	10
2.3.2 Operation mode service utility water.....	11
2.3.3 Operation mode summer.....	11
2.3.4 Mode stand-by.....	12
2.4 Setting of boiler parameters	12
2.5 Breakdowns	13

3.1. Installation

3.1 Norms and regulation	13
3.2 Placement of the boiler	13
3.3 Wall hung installation of the boiler	13
3.4 Electric installation of the boiler	13
3.4.1 Connection of the boiler to electric supply network.....	13
3.4.2 Installation of the room thermostat.....	14
3.4.3 Installation of three-ways valve for water heating in the storage water tank.....	14
3.5 Heating system	14
3.6 Expansion vessel	14
3.7 Marking of working scale	14
3.8 Circle pump	14

4. Ending of operation..... 16

5. Maintenance..... 16

6. Full delivery..... 16

7. Transport and warehousing..... 16

8. Claims..... 16

9. Way of liquidation..... 16

10. Enclosures..... 17

10.1 Installation of room thermostat..... 17

10.2 Face of control unit..... 18

Meaning of abbreviations and used symbols

- OV** - heating water
- TUV** - service utility water
- ZOV** - storage water tank
- TMV** - three ways valve



Notice pay attention

Dear customer,

You have bought modern product direct heated electric boiler Electric Easy from the company ATTACK, Slovak Republic. We believe that our product will serve you good and for long time. That is necessary to hold such principles. It is necessary for you to study whole instruction manual and hold all the principles. The declaration of conformity was issued by the producer according to directives 2004/108/EC, 2006/95/EC.

Basic features

- Boilers ATTACK are electric used water for heating. It is electric wall-hung appliance determined for heating of family houses or flats with heat loss to 7,5 kW .
- The boiler could be used for heating of service utility water through storage water tank.

Advantages of your boiler

SIMPLE CONTROL - your new boiler is in operation automatically. After boiler professional putting into operation is not necessary any additional setting. The boiler will adapt to conditions of heating system.

DIMENSIONS - your new boiler is really small regarding its dimensions.

Reminder! Your new boiler is not be alone to be useful for your comfort, use good outside insulation of your flat or your house, use the room thermostat for economical consumption of electric energy.

1. General information

1.1 Description and use

The wall hung electric boiler Electric Easy is convenient for heating in heating systems with forced circle and for heating of service utility water.

Heating water is heated in the boiler body by the heating element with output 7,5 kW inside. The heating element consists from 3 parts each of them has the output 2,5 kW. Heating operation is controlled by control unit with PID regulation. PID regulation assures high efficient operation due to minimalizing of heating water temperature overshoots over temperature setting. This regulation saves also your energy consumption. The boiler could be regulated by the room thermostat and is also able to heat service utility water in and independent storage water tank connected with 3-ways motoric

valve.

1.2 Advantages of boiler

- small dimensions, modern design
- high efficiency 99 %
- silent operation
- information on the display
- automatic regulation of boiler output economic operation
- stepless regulation of boiler output with continuous switching on/off heating elements
- rotation of heating elements ensuring elongation of boiler lifetime
- breakdowns diagnostic system with display indication
- information about heating system pressure thermo manometer
- operation mode Stand-by ensuring termination of boiler operation with all protective functions
- protective functions:
 - Antifreeze
 - Deblocking
 - Against overheating
 - Against pressure lost
- pump running out regulated
- possibility of a storage water tank connection
- possibility of a room thermostat connection
- possibility of operation for electric supply connection 1x 230 V or 2x 230/400 V
- automatic deaerating

1.3 Important instructions and advices

- Regarding installation, putting the boiler into operation and maintenance it is necessary to observe instructions according to concrete norms and regulations and instructions from the producer. It is necessary for you to read carefully instruction manual and guarantee conditions..
- Control if the boiler in the box is completed regarding accessories etc.
- Control if the boiler type is in accordance with your request for use.
- The data stated on the type label has to be compatible with conditions for boiler connection and mounting.

1.3.1 Installing, mounting of the boiler

- Safety and economic operation of the boiler requests a technical project made by authorized heating or civil engineer for whole heating system.
- Mounting of the boiler could be carried out only by authorized company or persons.
- On the boiler and 100 mm before the boiler there is not allowed placement of things from flammable materials.
- The boiler mounted on the wall is not able to be moved

or placed to another place.

- The boiler has to be connected by the nut with flange ring sealing.
- It is necessary to connect the heating water inlet with a filter and shut off valves.
- It is necessary to leave a free space on both side walls of the boiler 100 mm and minimally 400 mm from the top for after sales service. In case that you will not observe this request for free space you have to pay dismantling and mounting the boiler back to the wall and to heating system, it is not repair paid in guarantee period!

1.3.2 Putting into operation

- Putting the boiler into operation has to be carried out only by authorized professional company or service person that has a valid agreement signed with the producer. The list of these companies is enclosed.
- The company or person who will put the boiler into operation has an obligation to assure repairs of breakdowns or defects in guarantee period. In case that this company doesn't exist anymore, the guarantee repair will be assured by any company from the list closed to you.
- By putting the boiler into operation the authorized person is obligated to:
 - control connections of the boiler to electric supply network and to heating system
 - control tightness of the boiler
 - control all functions of the boiler
 - inform the user about boiler operation, its control and maintenance
 - inform the user about safety dimensions from sides of the boiler from flammable walls and its protection according to ČSN 061008 and ČSN 730823.
- To fulfill requests for boiler safety and economic operation it is necessary to observe below mentioned conditions:
 - for boiler mounting and installing the user has to get the permission from the company who is a distributor of electricity in your region, control the input of the boiler if it is in accordance with the input stated in the permission
 - the company carrying out the mounting is responsible to observe the technical project and concrete correlative norms and regulations regarding the mounting and installing of direct heated electric boilers in central heating systems.
 - for mounting of the boiler it is necessary to have an authorized technical project for heating system and for connection of the electric boiler
 - the boiler is able to be mounted only in an environment according to its determination and according to the project.
 - Manipulation, operation, using, control and maintenance of the boilers are forbidden if it is not in accordance with rules and directions of this instruction manual. It is forbidden mainly to disconnect any of safety units or elements in the boiler!!!

If the guarantee list is not filling fully, it is not valid.



NOTICE! If you take the boiler from colder environment to warmer (for example if the outside temperature is below 0° C or 0° C and you want to mount it inside), please wait approximately 2 hours

1.3.3 Operation of the boiler

- The boiler has to be controlled and used only according to advices and instructions stated in this instruction manual, only by adult person who was posted in maintenance of the boiler. Putting the boiler into operation will be made by authorized service person during the heating test.
- Any manipulation, operation, using and maintenance of the boiler, which is not in accordance with instructions and advices stated in this instruction manual, is inadmissible. The producer is not responsible for damages caused by wrong using and maintenance of the boiler.
- The producer recommends periodical service controls of the boiler, 1x per year before heating season. The service control could be done only by a professional authorized service company or person. The list of service control steps recommend to be controlled before heating season you will find in the chapter "maintenance".
- The producer allows only room thermostat connection, if the room thermostat has with potential-free outlet connection. The authorized service person is responsible during putting the boiler into operation to fill and sign the guarantee card.
- If you find any breakdown or any defect on an electrical part of the boiler, please, don't repair it by yourself, disconnect the boiler from the electric supply network and ask for after sales service repair your service person.
- It is not allowed to use the boiler Electric Easy for another purposes than is stated in this instruction manual.

1.3.4 Safety



Fire instructions:

Disconnect the boiler from the electric supply network and take it out of its operation according to possibilities. Extinguish fire using pulverized or snows extinguish appliance flammable and explosive materials. Don't stock any flammable and explosive things closed to the boiler (for example paper, colours, chemical etc.)

1.5 Technical data

Boiler type	Unit	ATTACK ELECTRIC EASY 8
Electric parameters		
Total electric input	kW	7,5
Nominal heating output	kW	7,5
Nominal current	A	3x12 / 1x36
Voltage	V	3x250/400 V+N+PE/50 HZ 1x250 V+N+PE/50 Hz
Nominal current max.	A	3x16 / 1x40
Pump input	W	60
Main circuit breaker	A	3x16 / 1x40
Nominal current of control fuse	A	0,315
Mechanical parameters		
Mechanical life time of relay	-	1 000 000 cyklů
Electrical life time of relay		250 000 cycles, 16 A, 250 V
Width	mm	370
Height	mm	625
Depth	mm	225
Boiler weight without water	kg	19
Environmental requests		
Min. working overpressure of heating systém	bar	0,4
Max. working overpressure of heating systém	bar	3
Operation overpressure recommended	kPa	100
Circle pump	-	CESAO 3
Maximal temperature of heating water	°C	80
Expanding temperature of thermostat blocked, opened-closed systém	°C	100
Water volume of whole boiler	l	5,8
Environmental kind ČSN 332000-3	-	normally AA5, AB5
Efficiency by nominal output	%	99
Supply cable CYKY	mm ²	3x2,5 / 1x6
Supply cable AYKY	mm ²	3x4 / 1x10
Expansion vessel	l	Not ineludet,volume read off ch.3.6
Surrounding temperature	°C	0 ÷ 40
Warehousing and transport temperature	°C	-30 ÷ + 70
Electromagnetic temperature	-	EN 55014, EN 50082-1
Humidity	%	0 ÷ 90 withouth condensation
Regulation		
Measuring accuracy	%	< 1
Accuracy of boiling water regulation	°C	± 1
Regulation type	-	PI
Remote control		
Cascade	-	with cascade controller
Service plug	-	6 PIN
Number of boilers in cascade max.	-	according cascade controller

1.6 Main parts

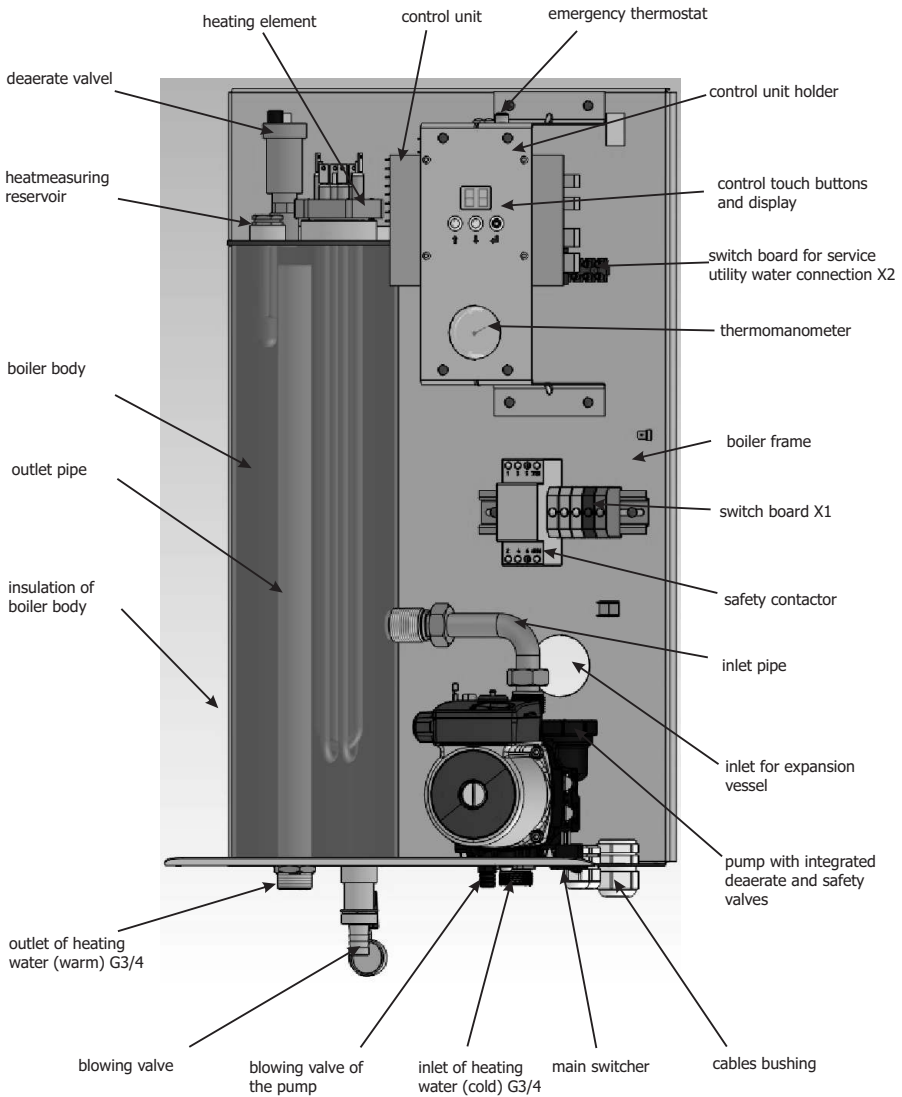

1.7 Description of function

1.7.1 Technical description

The boiler is designed according to valid norms and rules ČSN EN and IEC. The safety of the boiler, energy saving and sound was important matter during the boiler designing.

1.7.2 Principle of boiler operation

The insulated boiler body with volume is a reservoir where water is heated by electric heating elements. In dependency of heat request there are connected 1 = 2, 5 kW, 2 = 5 kW or 3 = 7, 5 kW heating elements. Circulation of water is through the pump. Safety of boiler operation is monitoring by several independent sensors. Whole heating process and pump operation is controlled by the control unit with display and push touch buttons. The button 0/1 is for switching off the boiler out of operation.

1.7.3 Control unit and control board Control unit has several functions which assure basic characteristics, mainly:

- ▶ safety functions assure protection against the detriment of health and property
- ▶ user's functions set by user
- ▶ operation functions internal functions of control unit import for sound operation of the boiler, but un-get-at-able for user

Control unit works with below mentioned inlet signals:

- ▶ temperature of heating water (sensor NTC)
- ▶ minimal operation pressure (switcher 230 V)
- ▶ maximal operation pressure (switcher 230 V)
- ▶ room thermostat (switcher 24 V)
- ▶ request service utility water (switcher 230 V).

Control unit controls:

- ▶ 3 heating elements
- ▶ pump operation
- ▶

1.7.4 Protection function of boiler

Antifreeze protection of the boiler

- ▶ This function protects the boiler against freeze and is active in the mode STAND-BY.
- ▶ Circulation pump and the boiler are in operation, if temperature of heating water decreases below 5° C. In this case the boiler assures minimal level of heating and the system is mildly warm, the boiler heats to 15° C temperature of heating water and after that the boiler set back to mode that it start to operate from.
- ▶ If the boiler is switch off or out of electric supply, this function is not active.

Unlocking protection of heating system

- ▶ It is active at all times if the circulation pump or 3-ways valve is more than 24 hours out of operation to protect blocking of the pump or the valve due to its small parts. This function avoids blocking of the pump rotor in mode STAND-BY and elongates its lifetime.
- ▶ The pump works 1 per day for 10 s.

1.7.5 Safety function of the boiler

Control unit

- ▶ The control unit is designed according to valid EU norms and is certified.
- ▶ The control unit has a protection against below and over voltage
- ▶ The control unit is protected by system Watch Dog-Timer with time 512 ms against its processor "blocking". In case that the processor is blocking the automatic reset function is activated and then the program is going with all parameters set from the point where it was broken.

Protection against overheating

- ▶ The boiler has a emergency thermostat set for 100° C. In case of boiler overheating heating elements are put out of operation independently to the control unit. This breakdown is signalling on the display as E2. This breakdown could be repaired only by authorized service man.

Protection against lost of heating water pressure

- ▶ The boiler is equipped with a pressure switcher which control minimal pressure in heating system 0,4 bar, when the function reliability of deaerate valves is assured, it means that the boiler has sufficient volume of water.
- ▶ In case of lost of heating water pressure below 0,4 bar the boiler signs the breakdown E3 and heating elements are put out of operation independently to the control unit.
- ▶ This breakdown could be repaired after the control of tightness of water ways and after water filling over 0,4 bar. After that the boiler is automatically reset and returned to normal operation.

Boiler protection against over and below voltage in supply electrical net

- ▶ The control unit is equipped with function assuring putting the boiler out of operation if the voltage is below 150 V or over 250 V. This stage is marked on the display with the blinking point in the low right corner of the display.
- ▶ When the voltage is OK = in the scale 150 250 V then the boiler returns to normal operation.

Boiler protection against overpressure of heating water

- ▶ The boiler pump is equipped with pressure safety valve set for 3 bars. In case of the overpressure more than 3 bars the leakage of water occurs from the valve till the pressure of water in heating system is not below maximal requested level.
- ▶ This valve is in its operation automatically.

1.8 Circuit diagram

Circuit diagram for the connection 1x 230 V

Control unit from the face to the transformer

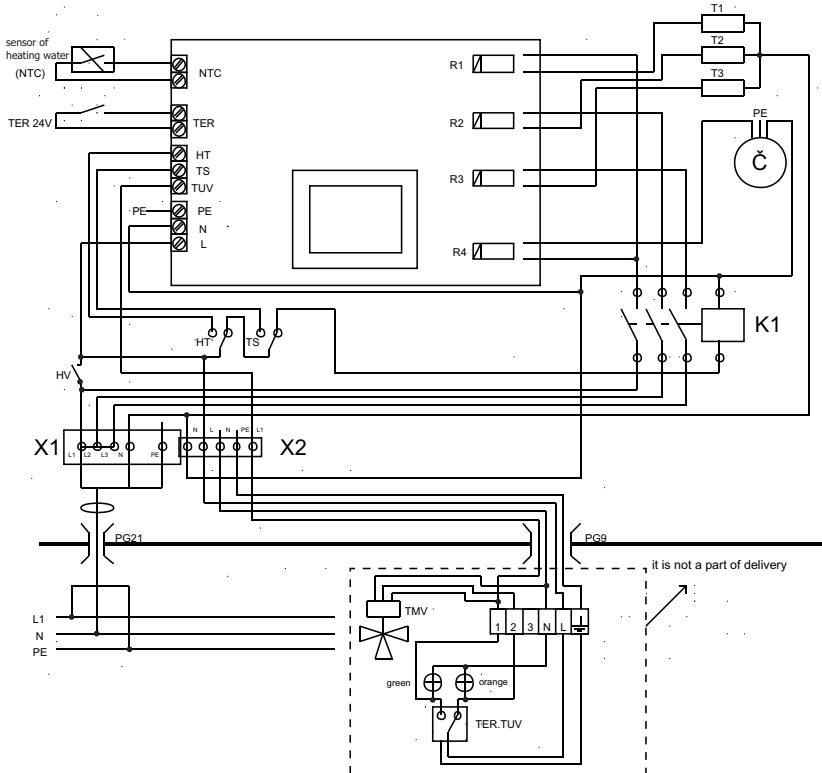

Legend:

NTC - NTC sensor
 TER - room thermostat
 HT - emergency thermostat
 TS - pressure switcher
 TUV - service utility water
 PE - protective conductor
 N - working conductor
 L - phase conductor
 HV - main switcher
 T1 - heating element 1
 T2 - heating element 2
 T3 - heating element 3
 Č - pump

K1 - contactor
 X1 - switch board 1
 X2 - switch board 2
 PG - bushing
 TMV - 3-ways motoric valve
 TER.TUV - thermostat of service utility water
 R1 - relay of heating element 1
 R2 - relay of heating element 2
 R3 - relay of heating element 3
 R4 - relay of the pump

Circuit diagram for connection to 3x230/400V

Control unit from face to transformer side.

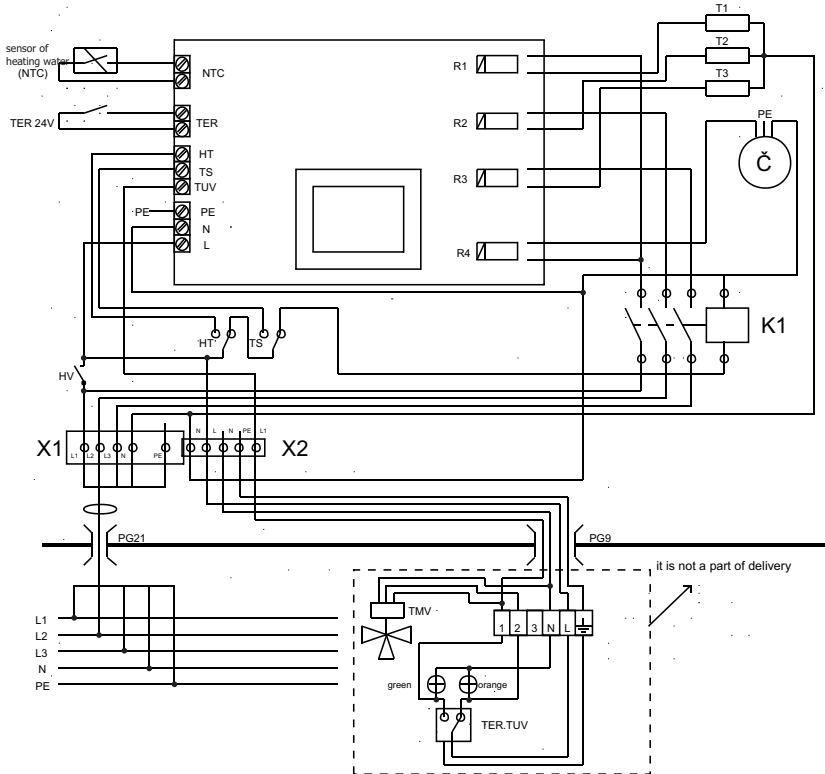

Legend:

NTC - NTC sensor
 TER - room thermostat
 HT - emergency thermostat
 TS - pressure switcher
 TUV - service utility water
 PE - protective conductor
 N - working conductor
 L - phase conductor
 HV - main switcher
 T1 - heating element 1
 T2 - heating element 2
 T3 - heating element 3
 Č - pump

K1 - contactor
 X1 - switch board 1
 X2 - switch board 2
 PG - bushing
 TMV - 3-ways motoric valve
 TER.TUV - thermostat of service utility water
 R1 - relay of heating element 1
 R2 - relay of heating element 2
 R3 - relay of heating element 3
 R4 - relay of the pump

2. Maintenance

2.1 Control panel

information about instantaneous/set temperature
mode information
breakdown information
information about parameters setting

point is lighting = setting
point is not lighting = operation

change of the parameter set (+)

change o the parameter set (-)

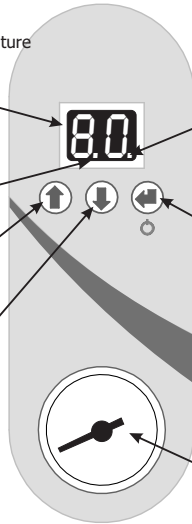

point is lighting = only 1 heating element is on
point is not lighting = no heating element is on
point is blinking = below/overvoltage in supply net

short pushing
- setting confirmation in memory
- return from the mode Stand-by
- frame for parameters setting
long pushing (approx. 3 s)
- going to mode Stand-by

information about instantaneous pressure of heating system.

2.2. Boiler switching ON/OFF

Is done with the switcher 0/1 placed on the lower side of boiler in the right lower corner (see the picture 1.6).
After boiler switching on you can see information on the display:

- > EL - Electric Easy - type of the boiler
- > 6 A - software number
- > 1.0 - software modification (např. 1.0)



The switch board and inlet supply connectors of clamps and the inlet supply connector are under voltage! Disconnect the boiler from the main inlet supply.

2.3 Modes

Important knowledge for setting:

- > During temperature setting the point between numbers are lighting.
- > During pause longer than 5 s the boiler returns to point before setting. In case of mistake setting (for example parameters) it is possible to wait 5 s and the boiler returns back or it is possible to push the button ENTER

without setting (without using /, the boiler returns to mode before setting.

- > Hold the button or and the value will roll automatically up or down .

2.3.1 Operation mode heating heating water on the display there is instantaneous temperature.

Without the room thermostat connected

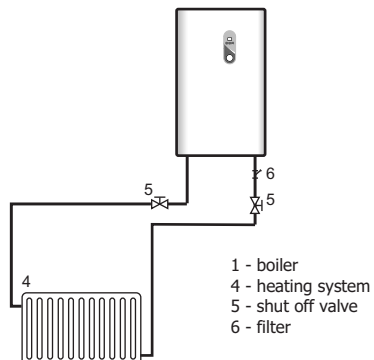

Regulation is controlled on the basis of the temperature setting of heating water and hysteresis.

Setting of heating water temperature:

Set the temperature requested on the control panel using the buttons (4),(5) (during setting the point between numbers are lighting) and confirm by (6) . After confirmation the temperature value set blinks for a minute and the setting marking is lost. The boiler now heats for temperature set by you. The scale for temperature setting is from 30 to 80° C (if you set the temperature below 30° C on the display there is the marking LE- summer regime, possibility to go back is by pushing (4).

If you don't confirm the temperature setting till 5 s, the boiler turns to the setting before. Use the room thermostat for economical operation of your heating system.

With the room thermostat connected

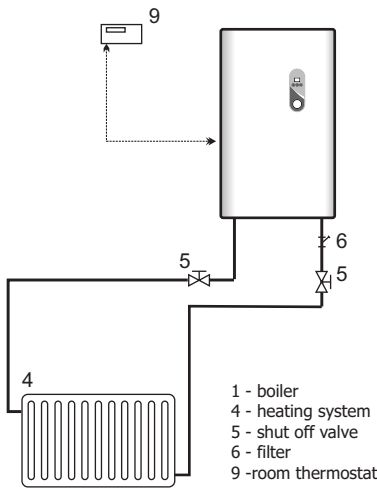

In case that you use the room thermostat in your heating system the regulation of heating water temperature is controlled similar till the moment when the request for heating is terminated (the temperature set on the room thermostat is fulfilled and the room thermostat is switch off).

2.3.2 Operation mode service utility water (on the display there is GB)

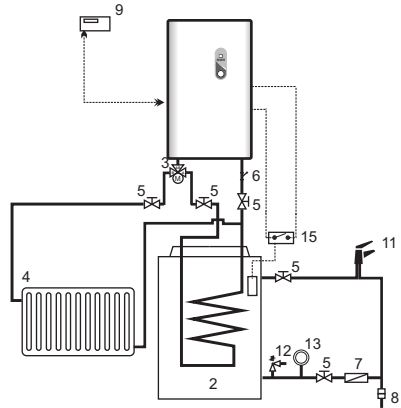

- 1 - boiler
- 2 - storage water tank
- 3 - 3ways motoric valve
- 4 - heating system
- 5 - shutt of valve
- 6 - filter
- 7 - back flap
- 8 - treatment of water
- 9 - room thermostat
- 11 - consumption place
- 12 - safety valve
- 13 - expansion vessel
- 15 - storage tank sensor

In case that you will heat service utility water through the storage water tank (the thermostat of tanks is switch on) the temperature regulation of service utility is controlled to value 85° C. This temperature is not possible to change. If the request for service utility water temperature is fulfilled (the thermostat of tank is switch off) the boiler returns to mode of heating water (heating water or mode summer).

This regime for boiler is automatic, is not possible to change it by the user.

2.3.3 Operation mode summer (on the display there is LE)

The boiler has not any reaction for the request of heating (room thermostat) and doesn't heat the system. The boiler accepts only request for service utility water heating and work like in the point 2.3.2 operation mode Service utility water.

Setting/termination of mode LE:

Reduce the temperature requested on the control panel by pushing the button **⊖** to 30° C and after next pushing **⊕** on the display there is **LE**, confirm it **⊕** and you are now in the mode Summer.

If you don't confirm your setting by pushing **⊕**, the boiler turns to setting before.

Stop the operation mode summer by pushing **⊖** and by setting the heating water temperature and by its confirmation **⊕**. The boiler heats now in the operation mode heating water (see the point 2.3.1).

2.3.4 Operation mode Stand-by (PF)

The boiler doesn't heat and also doesn't heat service utility water. There is only the antifreeze function on (if it is not blocked by the parameter 4) and deblocking pump function (1x per day pump turning through). We recommend using this function in case of putting the boiler out of the operation to elongate pump life time and protect heating system against freeze.

Going to the operation mode Stand-by: (PF):

Push the button **⊕** for a long time (minimally 3 s, during this period on the display there is lighting **PI**) and the boiler got to the operation mode Stand-by, on the display now there is lighting **PF**. If you want to go back to setting point, push shortly the button **⊕**.

2.4. Setting of boiler parameters

Summary of parameters:

Setting of parameters: It is necessary to push shortly the button **⊕** for setting all the parameters (operation mode of heating water, operation mode of service utility water or operation mode Summer. Using

the buttons **⊖**, **⊕** and choose the number of parameter you want to set. By pushing **⊕** you are able to set the value of the parameter. By its confirmation, by pushing **⊕** the new value of the parameter is now in memory and the boiler turns back to the mode before setting with new parameters set by the user.

The user is able to set only parameters 1 - 4. Parameters 5 - 7 could be set only by an authorized service man or by a producer and are blocked.

Description of parameters:

PI - option of pump type running out after termination of request for heating.

➤0 - there is not and pump running out, the pump is switched off with a last heating element

➤1 - pump running out is controlled by the parameter 2 set and after termination of request for heating the time is counting down till switching off the pump

➤2 - pump running out is controlled by the temperature of heating water set by the parameter 3 and after termination of request for heating the pump is on till the temperature of heating water fall down on the temperature value set.

PI2 - setting of time of pump running out after termination of request for heating.

PI3 - setting of temperature of heating water that the pump is in operation in after termination of request for heating.

PI4 - ON/OFF antifreeze function (see the chapter safety functions).

PI5 - setting of the value of regulating constant P, setting only by a producer!







PI6 - setting of the value of regulating constant I, setting only by a producer!!

PI7 - setting of hysteresis for the temperature in ° C

parameter	specification	value setting scale	producer setting	unit	responsible person for setting
PI1	pump running out: 0=none; 1=time running out; 2=temperature running out	0, 1, 2	1	-	user
PI2	time of pump running out	1 to 30, step 1	4	min.	user
PI3	temperature of pump running out	25 to 70, step 1	40	°C	user
PI4	antifreeze protection: 0=NO; 1=YES	0, 1	1	-	user
PI5	regulation constant P	1 to 20	6	-	producer
PI6	regulation constant I	1 to 50	3	-	producer
PI7	temperature hysteresis	1 to 10	2	°C	authorized service man.

requested (difference between the temperature of boiler when the boiler start to heat and the temperature requested) setting only by an authorized service man!!
 Notice: If you increase hysteresis you can reduce the number of cycles during relays switching on/off and elongate their lifetime.

FE - Go back to the production setting

- If you have set wrong parameters than it is possible for you to go back to the production setting. Values of parameters will be according below mentioned table:
 Going back to the production setting steps:
 - switch off the boiler by main switcher
 - push in the same time the buttons   
 - switch on the boiler by main switcher in the same time as you hold pushing the buttons    till the moment when on the display there is E lighting! FE
 - release the buttons and now the boiler is set according to the production setting.

2.5. Breakdowns, defects

In case that the boiler is broken then on the display there is E blinking with the number of the breakdown.
 List of breakdowns:

breakdown marking	specification	repair	breakdown reset
E1	Temperature of heating water higher than 99° C, or temperature sensor is broken (for example short circuit)	Call your service man	Automatically
E2	Overheated – the boiler is out of operation through the emergency thermostat.	Call your service man	Remove the blocking of the emergency thermostat (it is necessary to know the cause of overheating)
E3	Lost of pressure – pressure of heating system decreased	Check the tightness of heating system and fulfill water to have pressure higher than 0.4 bar.	Automatically
00	Disconnected or invalid temperature sensor or temperature below 0° C	If temperature is not increasing, call your service man.	Automatically



Breakdown of the boiler has to be repair only by professional person!
In case that you have a defect/breakdown and it is necessary to repair it only by an authorized service man, don't try to repair the boiler by yourself.
Attention There is threat of casualty by electric current.

3. Installation

3.1 Norms and regulations

For safety operation, projection, mounting, operation and service of boiler is valid below mentioned norms and regulations:

- ČSN 06 0310:2006 - Heating systems in buildings projection and mounting.
- ČSN 06 0830:2006 - Heating systems in buildings safety and protection equipment
- ČSN 06 1008:1998 - Fire safety of heating appliances

- ČSN 07 0240:1993 - Water and low pressure steam boilers basic rules
- ČSN 07 7401:1992 - Water and steam for heating energetic equipments
- ČSN 33 1310:1990 - Electrotechnical rules. Safety rules for electric equipments used by person without electric qualification
- ČSN 33 2000 -... Electrotechnical rules.
- ČSN 33 2130:1985 - Electrotechnical rules. Inside electrical distribution system.
- ČSN 33 2180:1980 - Electrotechnical rules, connection of electric appliances.
- ČSN EN 50110-1:2005 - Service and work with electrical appliances
- ČSN EN 55014:2001 -Electromagnetic compatibility requirements for home appliances, electric tools and similar appliances.
- ČSN EN 60335-1+A55:1997 - Safety of home electric appliances and for similar purposes.
- ČSN EN 61000 -...Electromagnetic compatibility (EMC)
- Law No. 22/1997 Technical requirements for products
- Government direction No. 178/1997 defined technical requirements for construction products + enclosure No. 1 basic requirements.
- Notice No. 48/1982 basic requirements to assure labour protection and safety of technical equipments

3.2 Placement of the boiler in the room

Room where the boiler will be placed and mounted on the wall has to be in accordance with normal environment AA5/AB5 according to ČSN 33 2000 3.
 It is not allowed for boilers to be installed in bathrooms, wash rooms, shower rooms in place 0, 1, 2, 3 according to the rule ČSN 33 2000-7-701.

Concerning fire protection and safety the rule ČSN 06 1008 is valid and there is stated minimal distance from flammable objects.

We recommend enlarging these distances to have minimal space for easier service and manipulation:

- 500 mm from the front side
- 600 mm from the top
- 200 mm from the side

3.3 Mounting of the boiler on the wall

Mounting is carried out by 2 screws or hooks which the boiler is hanged on through 2 inlets with spacing of holes 280 mm on the frame of the boiler.

3.4 Electroinstallation

3.4.1 Boiler connection to electric supply net

For boiler connection to electric supply net it is necessary for user to have a license from the local energetic distribution organization. Boiler input is not allowed to be bigger than the input stated in the license.

Before mounting of the boiler it is necessary to be installed supply electric cable with main switcher and with over current circuit breaker including starting inspection revise and to have confirmed application for electric power take-off.

Electric boilers are ranged in appliances continuously connected to electric circuit of network voltage. In the fix supply cable of the boiler there has to be in-built main switcher with distances of all disconnected cables min. 3 mm. The boiler is connected by corresponding cables to switch board X1 according to the diagram 1.7. Inlet of cables through the cover of boiler is carried out with bushing. The bushing PG21 is for main supply inlet of the boiler. Other bushings PG9 are for other signals room thermostat, 3ways valve.

Recommended size of circuit breaker and diameters of conductors:

Type of connection	Size of circuit breaker	Diameter of copper cable in mm	Diameter of aluminium cable in mm
3x230/400 V	3x16 A	3x2,5	3x4
1x230 V	1x40 A	1x6	1x10

Maximal diameter for switch board connection is EK 10 mm².

3.4.2 Installation of the room thermostat

- ▶ Connection of the room thermostat is necessary to do with twin core cable with recommended diameter from 0,5 to 1,5 mm² with length to 25 m.
- ▶ The cable for the room thermostat is not allowed to be placed in the same way with supply cord or another electric or industrial installation. Minimal separation is 10 mm.
- ▶ The switch board for the room thermostat connection (24 V) is placed in the left part of the control unit from front face and the second switchboard from the top with marking TER, the room thermostat has clamps with bridge from the production.

3.4.3 Installation of 3-ways valve for heating of service utility water in the storage water

- ▶ Connection of 3-ways is carried out according to the diagram 1,7 to the switch board X2. The conductor of service utility water signal 230 has to be minimally Cu 1mm² thick. The cable of valve is an accessory = the part of delivery.

3.5 Heating system

The pipe system of heating system has to be made to avoid forming of air bubbles and to make easy the process of deaeration. Deaeration valves have to be placed on each highest heating system place and on all the radiators. We recommend making the heating pipe from copper, but also it is possible to use steel or plastic pipes determined for heating system. Plastic pipes have to fulfil requests of heating resistance and have not to

loose parts in the heating water to avoid paralysation of regulation and safety function components, including the pump. The boiler has to be installed in opened or closed heating system according to the normative conditions (overpressure of heating system, maximal volume of h. The boiler could be used for underfloor heating, minimal temperature of heating water is 30 °C. The boiler has not equipped by the sensor of maximal temperature of heating water for underfloor heating.

Using of defrost mixture

We don't recommend to use defrost mixtures due to their characteristics, some of them are not convenient for the boiler operation, concretely reducing of heat transmission, big volume elasticity, ageing, breakdowns of rubber parts. It is necessary to think about to use them inevitable. Regarding inevitable situation it is allowed to use the defrost mixture Alicol Termo according to experience of the producer that the boiler operation is not reducing.

If you are not able to use this defrost mixture and you will protect your heating system with another defrost mixture then guarantee claim will not be accepted.

3.6 Expansion vessel

Installation

Expansion vessel is not assembled in the boiler, it is necessary to use and mount it separately in the heating system by professional company. Installation has to be carried out on the suction inlet of the pump.

Dimension

Expansion vessel eliminates dilatibility of heating medium in the heating system; therefore it is necessary to choose its sufficient volume. Size of expansion vessel is specified by the project specialist of heating system drawing. You can use for information about minimal volume of expansion vessel below mentioned curve. Curve is depended on temperature gradient 80/60°C a there are 3 curves for pressures of cold heating system 0,5, 1 and 2 bars. It is recommended to use the first bigger volume of standard expansion vessel for specification of minimal volume of expansion vessel. Curves are valid on condition that you use safety valve set on 3 bars.

Curves

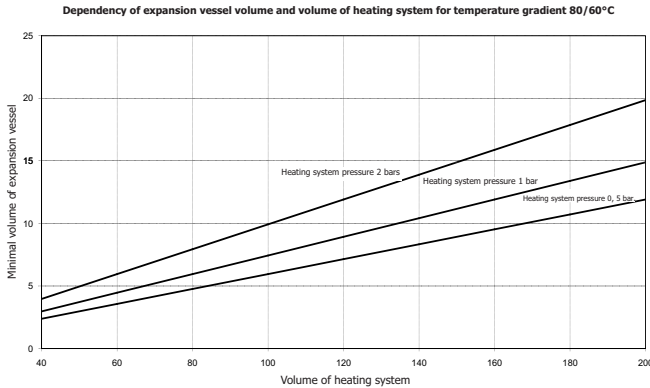

Filling overpressure of expansion vessel

It is necessary to observe overpressure of nitrogen filling for right function of expansion vessel in cold status of heating system according to formula:

$$P_{ex} = 1,2 \cdot P_{ov} \text{ (pressure of expansion vessel = } 1,2 \cdot \text{pressure of heating water)}$$

Overpressure changes of nitrogen filling of expansion vessel could be carried out only by responsible persons or professional companies.

- User has obligation to assure minimally 1 x per year to operation control and 1x per 9 years pressure control built-in expansion vessel or additional independent expansion vessel.

Minimal overpressure of heating water

Value of minimal pressure is stated in the table 1.5. Minimal overpressure has to be signed on the thermo manometer scale by person putting the boiler into operation. The overpressure has not to decrease under position marked on the scale. It is necessary sometimes to control and if it is necessary to fulfil filling overpressure of heating water.

Filling overpressure of heating water

Normally it is observed in case of first filling of heating system or in case of filling of minimal overpressure fall of heating water. Filling overpressure is + 0,2 bar higher than minimal overpressure specified for reason that temperature off filling water could be to 20°C (water dilatibility).

3.7 Marking of working scale

On the pressure meter placed under the boiler there is necessary to mark working scale that the pointer of pressure meter is moving in. Minimal pressure is marked by responsible person put the boiler into operation by pressure meter marking.

Maximal margin = maximal overpressure of heating

water in time of reaching of maximal temperature of heating water.

3.8 Circle pump

- The boiler has circle pump with 3 output grades.
- The pump operation is controlled by control unit depended on boiler regulation and safety requests.
- The pump operation is controlled by control unit depended on boiler regulation and safety requests.
- Time running out of the pump make possible to take away heat accumulated in the boiler body in time of switching off the boiler. The effect is decreasing of losses, removing of temperature tops, reducing of stone and elongation of boiler life time.
- Time running out of the pump is preset from the production facility according to the point 2.4
- The pump is protected against blocking in operation mode Stand-by. (see the chapter Protection functions). If the boiler is for longer time out of its operation switched off, we recommend you to switch on the boiler sometimes, minimally 1x per month (see the chapter protection of function).

Electric data of the pump

Output grade	P ₁ (W)	I (A)
1	50	0,22
2	60	0,27
3	70	0,31

P₁ - pump input
I - electric current

Working features of the pump Grundfos Cesao 3

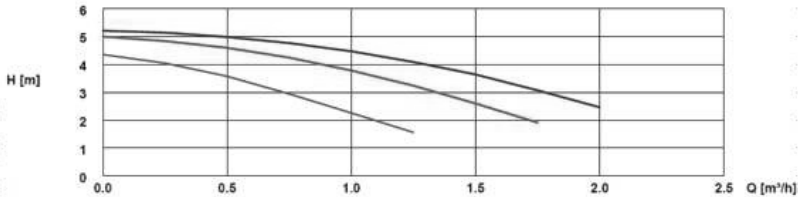

4. Termination of operation

- Concerning termination of boiler operation carry out it by switching off the switcher in the lower part of the boiler, by switching off the main switcher on the electric supply feeding.
- Service repairs see below mentioned instructions:



Disconnect boiler from electric supply feeding by main switcher and contact your service man!

Breakdowns of the boiler has to be repair only by professional person!



Attention! There is threat of casualty by electric current!

5. Maintenance

Regular maintenance helps you to eliminate possible defects. We recommend you to carry out complete maintenance 1 time per year before starting heating system. It is not allowed the taking off the cover. The user is able to clean surface of the cover with detergents and control operation modes or fill heating water to the system checked by water pressure dawn according to the value on the thermomanometer.

The service man during the regular control and maintenance carry out tightening of all electric connection, control tightness of all connection and control quantity of water in the heating system, clean the water filter, pump control 3-ways valve control and switching relay including starting function of the boiler. Well, also the control of all safety and switching elements will be carry out by heating operation and right function of heating elements.

6. Full delivery

The electric boiler is delivered assembled.

Full delivery of electric boiler consists of:

- electric boiler assembled,
- instruction manual,
- guarantee card,
- bushings,
- deaerate valve,
- bonding of switch board to electric supply connection 1x 230 V.

Accessories whose are not part of the full delivery:

- conductors for supply connection of boiler and three ways valve (in case that you have installed the storage water tank) and for connection of the room thermostat,
- fixing set.

7. Transport and warehousing

- The boiler is protected by its packaging during warehousing and transport. It is necessary to eliminate effects of magnetic and other influences on the packaging.
- It is necessary to eliminate concussions and to avoid slighting out the boiler from the packaging.
- Manipulate with the boiler and put it into position according instruction marked on the packaging.
- Regarding warehousing is necessary to assure standard warehousing conditions (no aggressive environment without dust, temperature from 5° C to 50° C, humidity to 75 %, no expose to biological influences, shocks and vibration).



8. Claims

- If you have functional and face defects on your boilers, please, do not repair it by yourselves.
- Please apply your claim by the company which put your boiler into operation or by guarantee repair companies stated in the list of guarantee place.
- Apply condition stated in the guarantee list.

► Your claim is not valid without fulfilled guarantee list.

9. Way of liquidation

Solid waste recycling

- mill board
 - PE bags, polystyrene binding tapes
- Boiler's recycling after its lifetime according to national normative waste recycling.

10. Enclosures

10.1 Installation of the room thermostat, see picture No. 34

Installation of the room thermostat, see picture No. 34

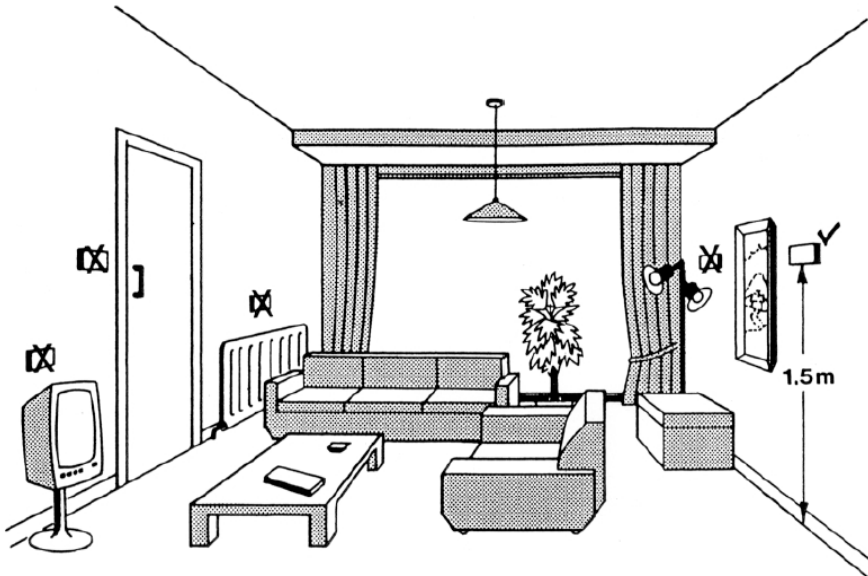

10.2. Control unit - diagram

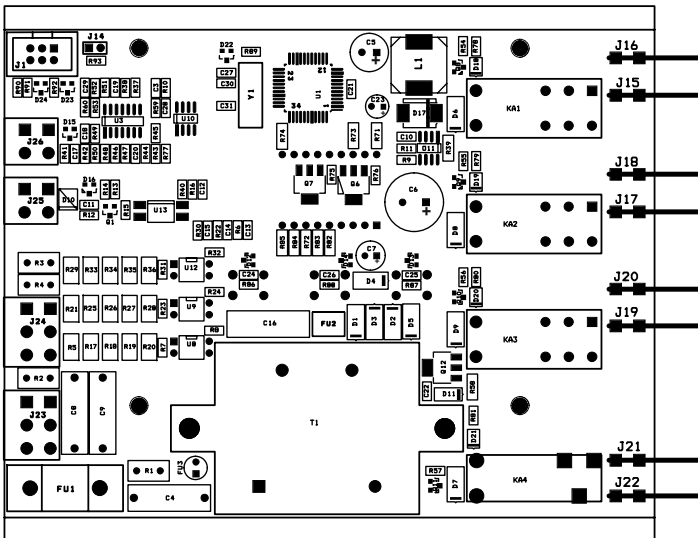
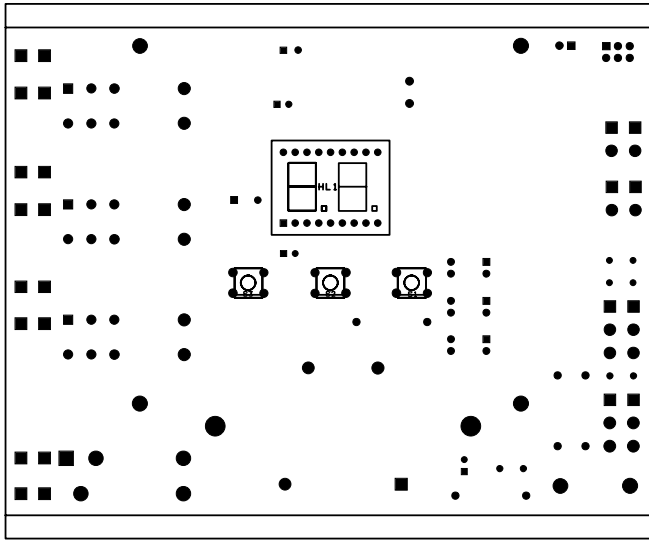

Information about processing of personal data

Dear Customer,

You provide us your personal information by completing and sending the Boiler start-up record and our company becomes your personal data manager in relation to you.

We hereby would like to inform you why and how we process your personal information, how we collect your personal information, for what purpose we handle it and the legal basis of such processing, how we handle personal data and what your rights are in relation to processing your personal data.

Please read the following information carefully before providing us your personal details.

In case of any questions related to the processing of your personal data, please do not hesitate to contact us at tel. no. 00421 43 400 3131 or support@attack.sk.

Privacy Manager:

ATTACK, s. r. o., with its registered office at Dielenská Kružná 5020, 038 61 Vrútky, Slovak Republic

Tel. : +421 43 4003 101

Fax. : +421 43 3241 129

E-mail: export@attack.sk

Web: <http://www.attack.sk>

Processing of personal data

We will only process the personal information you provide to us in the Boiler start-up record, i.e.:

- Name
- Surname
- Address
- Phone
- Type and serial number of the product

Purpose and legal basis for the processing of your personal data

We will process your personal data for the following purposes and on the basis of the following legal bases.

- 1) For the purposes of direct marketing, which is a legitimate interest of our company. The legal basis here is Art. Article 6 1. Letter. (f) Regulation (EU) 2016/679 of the European Parliament and of the Council of 27 April 2016 on the protection of natural persons with regard to the processing of personal data and on the free movement of such data, and repealing Directive 95/46/EC (General Data Protection Regulation).

The processing based on our legitimate interest, i.e. direct marketing, is following:

Your personal data will be stored in our electronic database which is managed directly and only by us. This electronic database is stored and secured on the property of our company. Your personal data will be used by our legitimate interest only in order to be able to send you an offer of our new products, especially in the event of the end of the expected life of product which you enter your personal data in the Boiler start-up record in if our company develops a newer and more technologically superior and better product that could replace the product in which you enter your personal data into the in the Boiler start-up record.

Direct marketing is our legitimate interest and the one of two purposes of processing of your personal data, i. e. direct offer of our products sent to you.

- 2) The legal basis for fulfilling the extended warranty agreement on the product in which you enter the Boiler Startup Record where your personal data is Art. Article 6 1. Letter.

(f) Regulation (EU) 2016/679 of the European Parliament and of the Council of 27 April 2016 on the protection of natural persons with regard to the processing of personal data and on the free movement of such data, and repealing Directive 95/46/EC (General Data Protection Regulation).

This processing that is required to meet the extended warranty agreement for a product you are one of the parties will be following:

Our company provides you with an extended contractual warranty (beyond the statutory warranty) in such situation that you comply with the warranty conditions (see the warranty conditions in the Instruction for use, in which there is the Boiler start-up record with your personal data). In order to provide you with this extended contractual warranty we need to know who is the other party and whether you are performing your obligations under this agreement especially the mandatory annual service inspections. Therefore we need you to send us a record of this inspection after each annual inspection (max. 5 inspections) and we will declare in our database that you fulfill the terms of the contractual guarantee.

Since each contract has at least two contracting parties we need your personal data to identify you as a party and identify a specific product for the purposes of fulfilling the extended warranty agreement. We would not be able to fulfill our obligations under the extended warranty agreement properly without these data.

Our legitimate interest and one of the two purposes of processing your personal data is therefore the fulfillment of the contract, that is, the fulfillment of the contract for extension of the contractual guarantee.

Processing of personal data for both purposes is done manually and also in electronic information systems. However these systems are subject to rigorous and constant physical and technical control. All persons who, on the basis of our instructions and our credentials, come in contact with personal data in the framework of their work or contractual obligations are bound by confidentiality.

Category of recipients of personal data

We process your personal data primarily by ourselves. However it may happen that we will have to use the services of another entity to process personal data for any of the above mentioned purposes. In this case the relationship between us and the third party will be the relationship between the administrator and the processor and we will make an agreement with this processor about the processing of the personal data in order to guarantee the security and legality of processing your personal data.

Your personal data may therefore be sold to the recipient of the following categories:

- a) A company that distributes our products in the territory of a member state of the European Union in which you have purchased a product which you enter your personal data in the Boiler start-up record in or in which such a product is put into service on your request
- b) A company providing bulk mailing services

The length of time the personal data will be stored

We will process your personal data for at least the duration of the contractual warranty (i.e. for 5 years) for the purposes of fulfilling the warranty agreement and at most for the time of assumed lifetime of the products for which the Boiler start-up record for the purposes of direct marketing.

Raising objections to processing of personal data

Whenever you have the right to object to our processing of your data for direct marketing purposes (see Purpose and legal basis for processing your personal data, item 1) above). If you have

an objection to our processing of your direct marketing data, by the date of your objection will cease our processing your personal data for direct marketing purposes.

The objection to the processing of your personal data for direct marketing purposes can be sent to us by post to:

ATTACK, s. r. o., Dielenská Kružná 5020, 038 61 Vrútky, Slovak Republic. In the objection, it is sufficient to provide the name, address and the text "I hereby raise an objection to the processing of my personal data for the purposes of direct marketing" and your signature. We always inform you about the accepting your request without delay.

Please note that the right to object can not be invoked against our processing of your personal data necessary for the purpose of fulfilling the extended warranty agreement.

Your other rights related to the processing of personal data

Please note that you also have the following rights in relation to our processing of your personal information:

- to ask for information about what personal data is processed by us,
- to request access to these data and let them update or fix,
- to require the deletion of these personal data, or the limitation of their processing,
- to raise objection to the processing of your personal data,
- the right to the portability of your personal data,
- in case of doubt regarding compliance with the obligations related to the processing of your personal data, contact the Administrator or the Office for Personal Data Protection.

You may enforce these rights to our company by the same procedure as the right to raise objections to the processing of personal data.



Warranty Certificate

The product meets technical standards and technical conditions. The product was made according to valid drawing documentation with the required quality and approved by the State testing institute.

Guarantee

The company ATTACK, s.r.o. warrants for this product only if there have been met conditions of the warranty in time 24 months - 2 years - from the date of starting the boiler up.

The serial num. of the boiler:

Type:

Insert barcode here

Date of shipment from manufacturer:

The warranty conditions:

The warranty covers all faults of the device and its components that have resulted from faulty material or mistakes made by processing of the material.

The warranty does not apply to gaskets, sealing cords, insulating materials, fireclay fillings, ignition spirals.

The warranty for the device is subject to the following conditions:

- a warranty card fully completed will be submitted to the complaint
- the installation of the equipment was carried out by a qualified employee of a professional installation company
- assembly and commissioning were confirmed in the warranty card
- the device will be used exactly according to the manufacturer's instructions and recommendations which are listed in the installation manual
- if the system has been cleaned before installing and starting the system, the treated heating water and the mounted filter

In the absence of any defect or fault caused by unprofessional operation by the customer, the costs associated with the work of the serviceman/technician are covered by the person who required for the repair.

The warranty claim expires and does not cover faults and damages that have arisen from:

- damage during transport
- breaking the rules about the installation, operating and maintenance instructions from the instructions of use
- violent mechanical damage
- unprofessional repairs or modifications, unprofessional operation and transportation
- if the warranty card is not completed properly
- a natural calamity
- arbitrary customer's conversion of device
- by making a design change or by modifying the text of the warranty certificate
- do not carry out a mandatory service visit within a given time
- install the device in a dirty and aggressive environment
- by clogging or clogging the boiler body with dirt from the system and water

The boiler is not subject of the warranty if:

- it is not operated with the prescribed fuel:
- for gasification boilers - wood with a humidity content not exceeding 20%, or with a fuel not specified by the manufacturer
- for pellet boilers - wood pellets of 6 mm diameter, max. length 35 mm, according to DIN 51 731-HP 5 or DIN Plus or EN 14961-2-A1
- Regumat ATTACK-OVENTROP will not be installed in the system to ensure that the boiler return temperature is at least 65 °C during operation
- there is no functional thermostatic valve installed to the boiler for cooling circuit connected to the cooling water source
- it is not connected to the chimney with the prescribed dimensions specified in the operating instructions

Instructions for complaint:

To make a warranty service, please contact the appropriate serviceman/technician with the following information:

- the exact address and contact of the user where the device is installed
- the approximate nature of the fault
- when and by whom device has been installed and put into operation
- device type, serial number and date of manufacture

After completing there will be made a record of reparation and the user will confirm the work.

The serviceman/technician is obligated to keep the user proof of repair. If the Service Officer detects any device interference or other damage and does not carry out the required service inspection, he is required to notify the user that the repair will be carried at his own expense and at the same time loses his / her entitlement to the next warranty.



ATTACK, s.r.o. • Dielenská Kružná 5020, 038 61 Vrútky • Slovakia
Tel: +421 43 4003 101 • Fax: +421 43 3241 129 • E-mail: kotle@attack.sk
Export – tel: +421 43 4003 115 • Fax: +421 43 3241 129 • E-mail: export@attack.sk



ATTACK, s.r.o. producer reserves the right to change technical parameters and dimensions of boilers without previous warning.