



<ORIGINAL>



CITY MULTI Control System
and Mitsubishi Mr. SLIM Air Conditioners

MA Touch Remote Controller

PAR-CT01MAA-PB

PAR-CT01MAA-SB

PAR-CT01MAA-S

PAR-CT01MAR-PB

PAR-CT01MAR-SB

Instruction Book

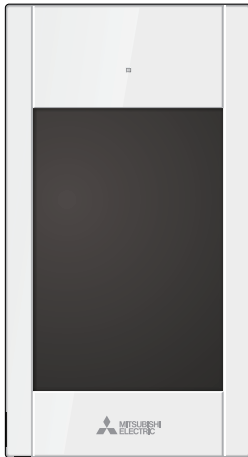

English

Français

Español

Italiano

Português

Ελληνικά

Türkçe

Svenska

Deutsch

Nederlands

Русский

Český

Magyar

Polski

Dansk

Prior to use, thoroughly read the instructions in this manual to use the product correctly.
Retain for future reference.



Make sure that this CD-ROM and the Installation Manual are passed on to any future users.
To ensure safety and proper operation of the remote controller, the remote controller should
only be installed by qualified personnel.

Contents

Safety precautions.....	4
Controller components	6
Controller interface - Status display/Main display	6
Controller interface - Menu screen	8
Display - Status display/Main display	10
Menu structure and icons	12
Menu structure	12
Icon explanations	15
Basic operations	16
Power ON/OFF	16
Operation mode, temperature, fan speed, vane, louver, and ventilation (Lossnay) settings	17
Navigating through the menu	22
Main menu list.....	22
Navigating through the Main menu	24
Function settings	25
High power.....	25
Manual vane angle	26
Timer (On/Off timer).....	29
Timer (Auto-Off timer)	32
Weekly timer	34
OU silent mode	37
Night setback	40
Restriction	43
Energy saving	49
Clock	54
Daylight saving time	56
Main display	58
Icon explanation.....	59
Brightness	61
Language selection	62
Design.....	64
Touch panel calibration	66
Touch panel cleaning	68
Initialize remote controller	70
Remote controller information	72
Troubleshooting	74
Error information	74
No occupancy Auto-OFF	77
Maintenance	78
Filter information	78
Specifications	80
Controller specifications.....	80
Function list (as of October 1, 2017).....	81
List of functions that can/cannot be used in combination ..	82

Safety precautions

- Thoroughly read the following safety precautions before using the unit.
- Observe these precautions carefully to ensure safety.

 WARNING	Indicates a risk of death or serious injury.
 CAUTION	Indicates a risk of serious injury or structural damage.

- After reading this manual, pass it on to the end user to retain for future reference.
- Keep this manual for future reference and refer to it as necessary. This manual should be made available to those who repair or relocate the controller. Make sure that the manual is passed on to any future users.

General precautions

WARNING

Do not install the unit in a place where large amounts of oil, steam, organic solvents, or corrosive gases, such as sulfuric gas, are present or where acidic/alkaline solutions or sprays are used frequently. These substances can compromise the performance of the unit or cause certain components of the unit to corrode, which can result in electric shock, malfunctions, smoke, or fire.

To reduce the risk of shorting, current leakage, electric shock, malfunctions, smoke, or fire, do not wash the controller with water or any other liquid.

To reduce the risk of electric shock, malfunctions, smoke or fire, do not operate the switches/buttons or touch other electrical parts with wet hands.

When disinfecting the unit using alcohol, ventilate the room adequately. The fumes of the alcohol around the unit may cause a fire or explosion when the unit is turned on.

To reduce the risk of injury or electric shock, before spraying a chemical around the controller, stop the operation and cover the controller.

To reduce the risk of injury or electric shock, stop the operation and switch off the power supply before cleaning, maintaining, or inspecting the controller.

If any abnormality (e.g., burning smell) is noticed, stop the operation, turn off the power switch, and consult your dealer. Continued use of the product may result in electric shock, malfunctions, or fire.

Properly install all required covers to keep moisture and dust out of the controller. Dust accumulation and water can cause electric shock, smoke, or fire.

CAUTION

To reduce the risk of fire or explosion, do not place flammable materials or use flammable sprays around the controller.

To reduce the risk of damage to the controller, do not directly spray insecticide or other flammable sprays on the controller.

To reduce the risk of environmental pollution, consult an authorized agency for proper disposal of remote controller.

To reduce the risk of electric shock or malfunctions, do not touch the touch panel, switches, or buttons with a pointy or sharp object.

To reduce the risk of injury and electric shock, avoid contact with sharp edges of certain parts.

To reduce the risk of injury, wear protective gear when working on the controller.

To avoid injury from broken glass, do not apply excessive force on the glass parts.

Precautions for moving or repairing the controller

WARNING

The controller should be repaired or moved only by qualified personnel. Do not disassemble or modify the controller. Improper installation or repair may cause injury, electric shock, or fire.

CAUTION

To reduce the risk of shorting, electric shock, fire, or malfunction, do not touch the circuit board with tools or with your hands, and do not allow dust to accumulate on the circuit board.

Additional precautions

To avoid damage to the controller, use appropriate tools to install, inspect, or repair the controller.

To avoid discoloration, do not use benzene, thinner, or chemical rag to clean the controller. To clean the controller, wipe with a soft cloth soaked in water with mild detergent, wipe off the detergent with a wet cloth, and wipe off water with a dry cloth.

This controller is designed for exclusive use with the Building Management System by Mitsubishi Electric. The use of this controller for with other systems or for other purposes may cause malfunctions.

To avoid damage to the controller, provide protection against static electricity.

This appliance is not intended for use by persons (including children) with reduced physical, sensory or mental capabilities, or lack of experience and knowledge, unless they have been given supervision or instruction concerning use of the appliance by a person responsible for their safety. Children should be supervised to ensure that they do not play with the appliance.

This appliance is intended to be used by expert or trained users in shops, in light industry and on farms, or for commercial use by lay persons.

If the supply cord is damaged, it must be replaced by the manufacturer, its service agent or similarly qualified persons in order to avoid a hazard.

Controller components

Controller interface - Status display/Main display

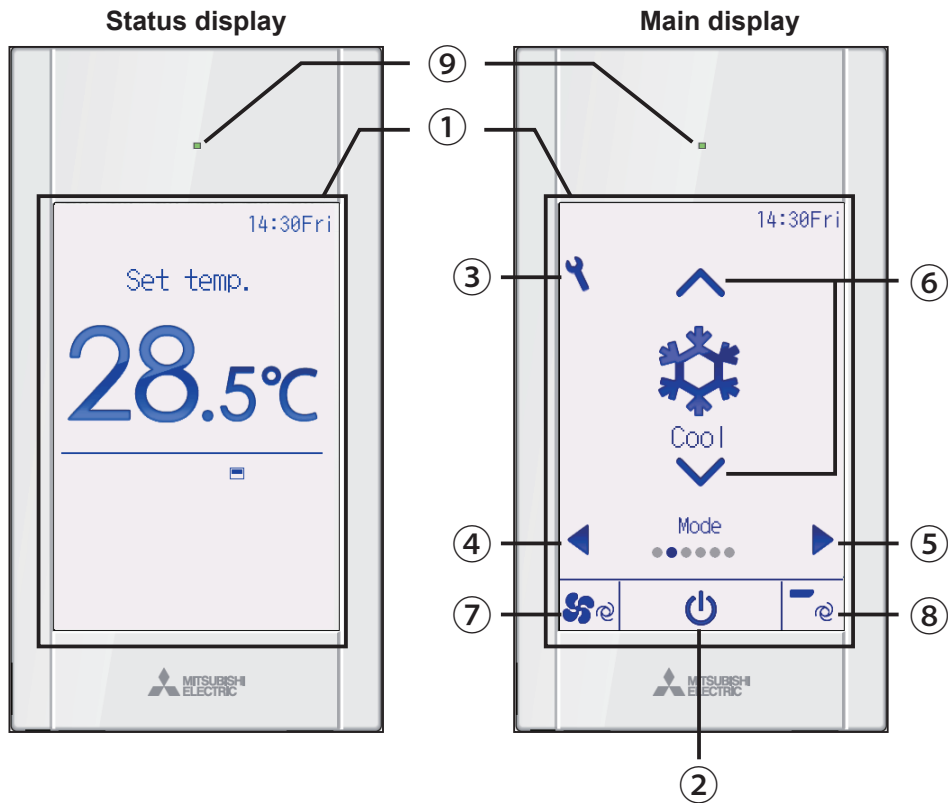

① Touch panel & Backlit full color LCD

Operation settings will appear. When the backlight is off, pressing any area switches the screen to the Status display. While the Status display is displayed, pressing any area switches the screen to the Main display.

② ON/OFF button

Press to turn ON/OFF the indoor unit.

③ Setting button

Press to bring up the Main menu. When the menu operation is locked, an administrator password is required.

④ ◀ button

Press to switch the setting items in the following order: louver, ventilation, vane, fan speed, operation mode, and preset temperature.

⑤ ▶ button

Press to switch the setting items in the following order: preset temperature, operation mode, fan speed, vane, ventilation, and louver.

⑥ ▲ ▼ button

Press to change the contents of the setting selected in ④ and ⑤ above.

⑦ Fan speed shortcut button

Press to directly access the fan speed settings screen.

⑧ Vane shortcut button

Press to directly access the vane settings screen.

⑨ ON/OFF lamp

This lamp lights up in green while the unit is in operation unless "LED lighting" is set to "No". It blinks while the remote controller is starting up or when there is an error.

When the ON/OFF operation is locked, ② will not be displayed.

When the setting item is switched with the ④ or ⑤ button, if the operation of the selected setting item is locked, the item will not be displayed.

If the operation of the fan speed or vane is locked, the item ⑦ or ⑧ will not be displayed.

The setting contents cannot be changed with the ⑥ button when the setting item is centrally controlled by the system controller.

Controller components

Controller interface - Menu screen

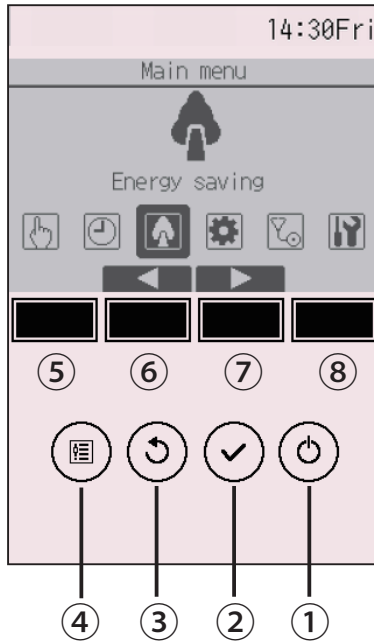

① ON/OFF button

Press to turn ON/OFF the indoor unit.

② SELECT button

Press to save the setting.

③ RETURN button

Press to return to the previous screen.
When the Main menu is displayed, pressing this button will display the Status display.

④ MENU button

Page 24

Press to bring up the Main menu.

⑤ Function button F1

Menu screen: The button function varies with the screen.

⑥ Function button F2

Main menu: Press to move the cursor left.
Menu screen: The button function varies with the screen.

⑦ Function button F3

Main menu: Press to move the cursor right.
Menu screen: The button function varies with the screen.

⑧ Function button F4

Menu screen: The button function varies with the screen.

The functions of the function buttons change depending on the screen. Refer to the button function guide that appears at the bottom of the LCD for the functions they serve on a given screen.

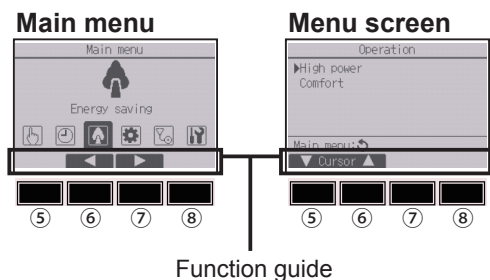

Controller components

Display - Status display/Main display

The Status display and Main display can be displayed in two different modes: "Full" and "Basic."

The factory setting is "Full." For how to switch the mode, refer to page 58.

Full mode

* All icons are displayed for explanation.

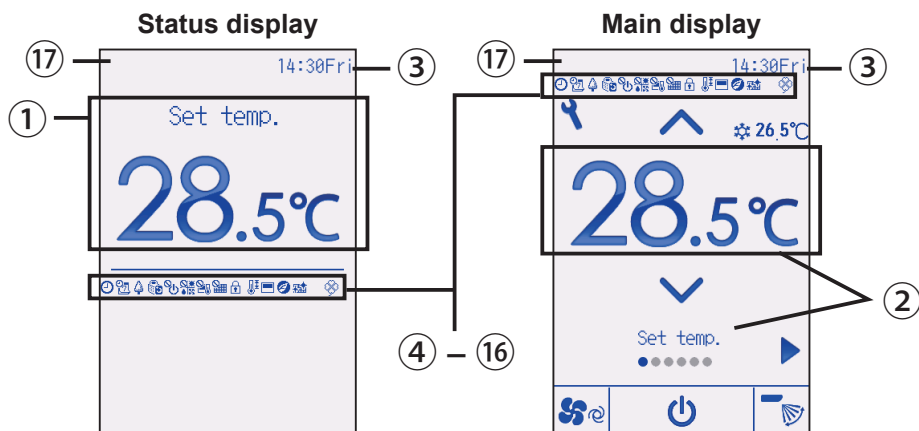

Basic mode

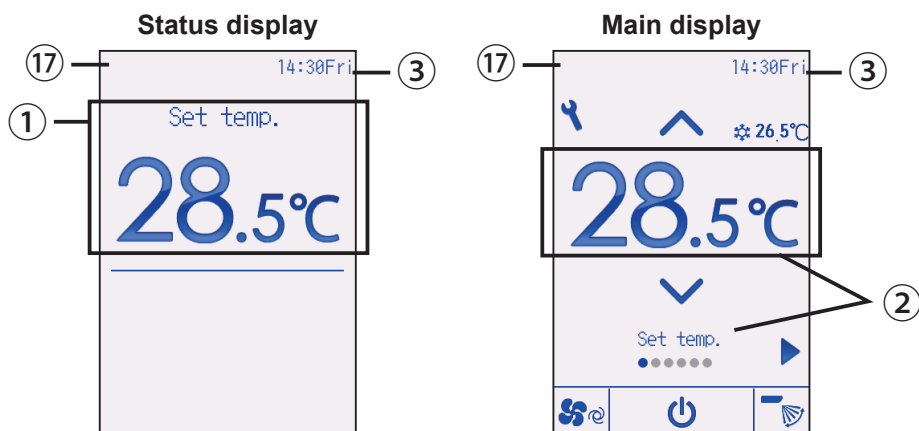

① Preset temperature or room temperature

Preset temperature or room temperature appears here.
(See the Installation Manual.)

② Setting item and setting contents Page 17

The setting items “Preset temperature” ↔ “Operation mode” ↔ “Fan speed” ↔ “Vane” ↔ “Ventilation” ↔ “Louver,” and their setting contents appear here.
“Centrally controlled” appears for a certain period of time when a centrally-controlled item is operated.

③ Clock

Current time appears here.
(See the Installation Manual.)

④ Page 29, 32, 40

Appears when the On/Off timer (Page 29), Night setback (Page 40), or Auto-off timer (Page 32) function is enabled.

 appears when the timer is disabled by the centralized control system.

⑤ Page 34

Appears when the Weekly timer is enabled.

⑥ Page 51

Appears while the units are operated in the energy-save mode. (Will not appear on some models of indoor units)

⑦ Page 37

Appears while the outdoor units are operated in the silent mode.

⑧ Page 17

Appears when the ON/OFF operation is centrally controlled.

⑨ Page 17

Appears when the operation mode is centrally controlled.

⑩ Page 17

Appears when the preset temperature is centrally controlled.

⑪ Page 46

Appears when the filter reset function is centrally controlled.

⑫ Page 46

Appears when the buttons are locked.

⑬ Page 43

Appears when the preset temperature range is restricted.

⑭ Page 43

Appears when the built-in thermistor on the remote controller is activated to monitor the room temperature.

 appears when the thermistor on the indoor unit is activated to monitor the room temperature.

⑮ Page 34

Appears when an energy-saving operation is performed using a “3D i-See sensor” function.

⑯ Page 78

Indicates when filter needs maintenance.

⑰ Preliminary error display

An error code appears during the preliminary error.

Menu structure and icons

Menu structure

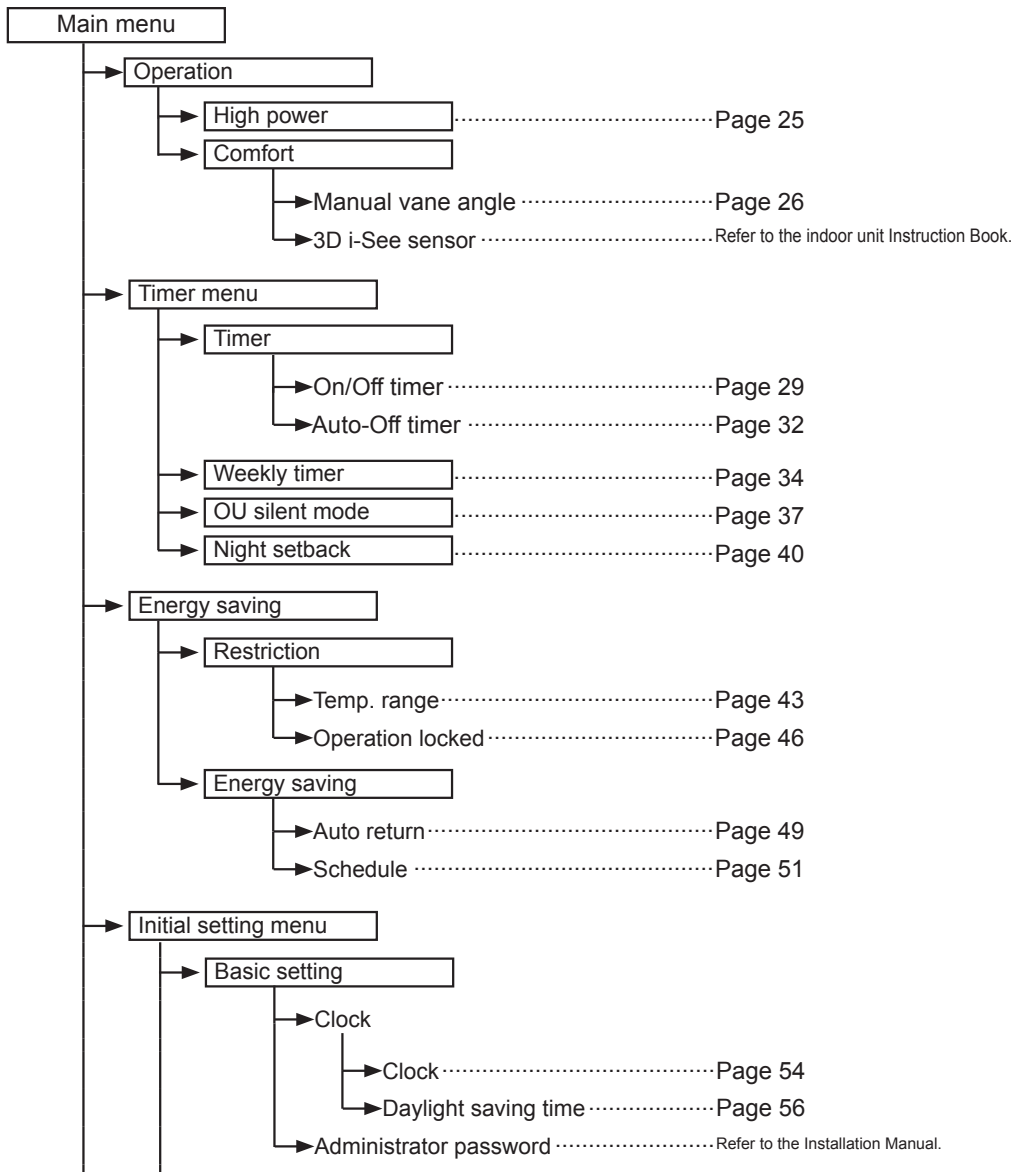

→	Display setting	
→	Main display	Page 58
→	Display details (Icon explanation etc.)	Refer to the Installation Manual.
→	Brightness	Page 61
→	Language selection	Page 62
→	Design	Page 64
→	Operation setting	
→	Auto mode	Refer to the Installation Manual.
→	Touch panel	Page 66
→	Maintenance menu	
→	Error information	Page 74
→	Filter information	Page 78
→	Cleaning	
→	Auto descending panel	Refer to the Instructions Manual that came with the automatic elevating panel.
→	Descending operation	Refer to the Instructions Manual that came with the automatic elevating panel.
→	Descending adjustment	Refer to the Instructions Manual that came with the automatic elevating panel.
→	Service menu	
→	Test run menu	
→	Test run	Refer to the indoor unit Installation Manual.
→	Drain pump test run	Refer to the indoor unit Installation Manual.
→	Maintenance information	Refer to the indoor unit Installation Manual.
→	Model name input	Refer to the indoor unit Installation Manual.
→	Serial No. input	Refer to the indoor unit Installation Manual.
→	Dealer information input	Refer to the indoor unit Installation Manual.
→	Initialize maintenance info.	Refer to the indoor unit Installation Manual.

Menu structure and icons

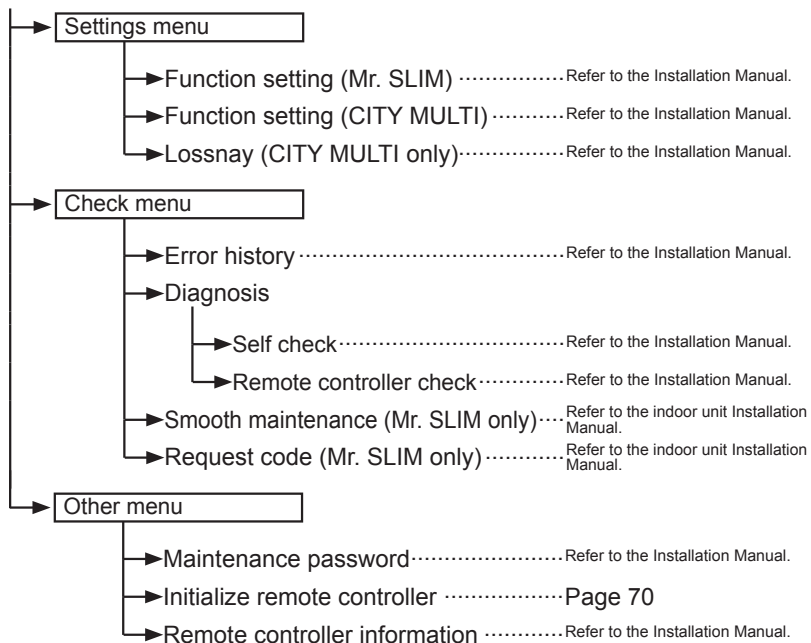

Not all functions are available on all models of indoor units.

Icon explanations

Controller operation

Timer



The table below summarizes the square icons used in this manual.



The administrator or maintenance user password must be entered on the password input screen to change settings. There is no settings that can skip this process.

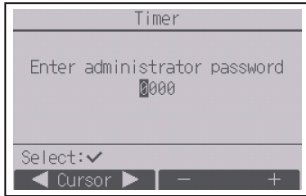

- F1** : Press to move the cursor left.
- F2** : Press to move the cursor right.
- F3** : Press to decrease the value by 1.
- F4** : Press to increase the value by 1.

* Changes cannot be made unless the correct password is entered.

F1 F2 F3 F4



Indicates settings that can be changed only while the units are in operation.



Indicates settings that can be changed only while the units are not in operation.



Indicates settings that can be changed only while the units are operated in the Cool, Heat, or Auto mode.



Indicates functions that are not available when the buttons are locked or the system is centrally controlled.

Basic operations

Power ON/OFF



Button operation

ON

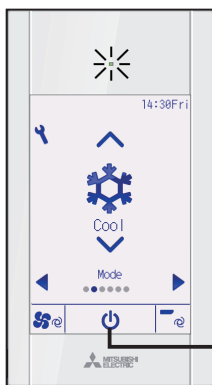

ON/OFF button

Press the **ON/OFF** button.

The ON/OFF lamp will light up in green, and the operation will start.

When “LED lighting” is set to “No,” the ON/OFF lamp will not light up.

OFF



Press the **ON/OFF** button again.

The ON/OFF lamp will come off, and the operation will stop.

Operation mode, temperature, fan speed, vane, louver, and ventilation (Lossnay) settings



Button operation

Operation mode

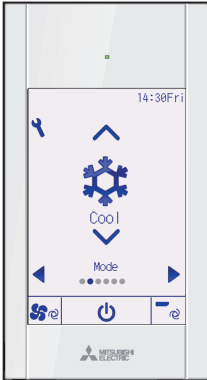

Each pressing of the ▼ or ▲ button cycles through the following operation modes.

Select the desired operation mode.



Cool



Dry



Fan



Auto



Heat

- Operation modes that are not available to the connected indoor unit models will not appear on the display.

What the blinking mode icon means

The mode icon will blink when other indoor units in the same refrigerant system (connected to the same outdoor unit) are already operated in a different mode. In this case, the rest of the unit in the same group can only be operated in the same mode.

<Auto (dual set point) mode>

When the operation mode is set to the Auto (dual set point) mode, two preset temperatures (one each for cooling and heating) can be set. Depending on the room temperature, indoor unit will automatically operate in either the Cool or Heat mode and keep the room temperature within the preset range.

The graph below shows the operation pattern of indoor unit operated in the Auto (dual set point) mode.

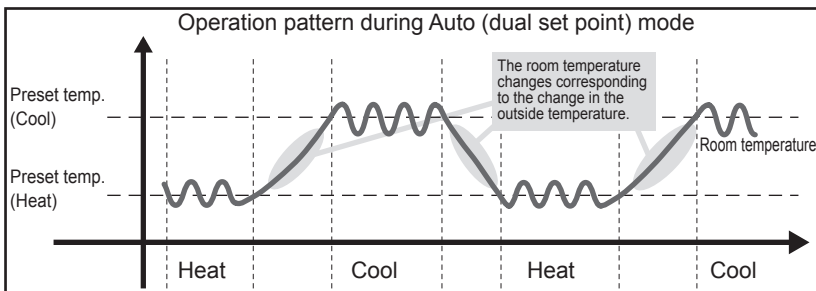

Basic operations

Preset temperature

<Cool, Dry, Heat, and Auto (single set point)>

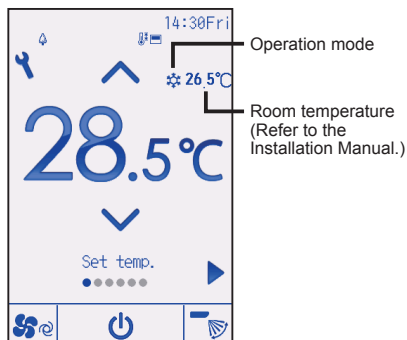

Press the button to decrease the preset temperature, and press the button to increase.

- Refer to the table on page 19 for the settable temperature range for different operation modes.
- Preset temperature range cannot be set for Fan/Ventilation operation.
- Preset temperature will be displayed either in Centigrade in 0.5- or 1-degree increments, or in Fahrenheit, depending on the indoor unit model and the display mode setting on the remote controller.

<Auto (dual set point) mode>

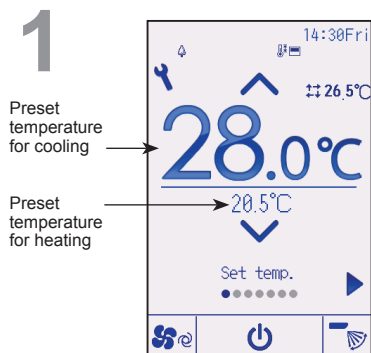



The current preset temperatures will appear. Each pressing of the or button switches the preset temperatures for cooling and heating.

2

Preset temperature for cooling

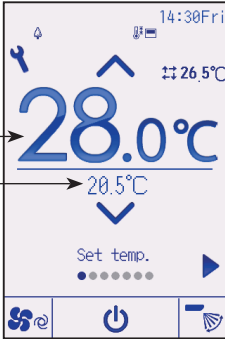
Preset temperature for heating



Press the  button to decrease the selected temperature, and press the  button to increase.

- Refer to the table below for the settable temperature range for different operation modes.
- The preset temperature settings for cooling and heating in the Auto (dual set point) mode are also used by the Cool/Dry and Heat modes.
- The preset temperatures for cooling and heating in the Auto (dual set point) mode must meet the conditions below:
 - Preset cooling temperature is higher than preset heating temperature.
 - The minimum temperature difference requirement between cooling and heating preset temperatures (varies with the models of indoor units connected) is met.
 - If preset temperatures are set in a way that does not meet the minimum temperature difference requirement, both preset temperatures will automatically be changed within the allowable setting ranges.

Settable preset temperature range

Operation mode	Preset temperature range
Cool/Dry	19 ~ 30 °C (67 ~ 87 °F)
Heat	17 ~ 28 °C (63 ~ 83 °F)
Auto (Single set point)	19 ~ 28 °C (67 ~ 83 °F)
Auto (Dual set points)	[Cool] Preset temperature range for the Cool mode [Heat] Preset temperature range for the Heat mode
Fan/Ventilation	Not settable

The settable temperature range varies with the model of indoor units.

Basic operations

Fan speed



Each pressing of the ▼ or ▲ button cycles through the following fan speeds.

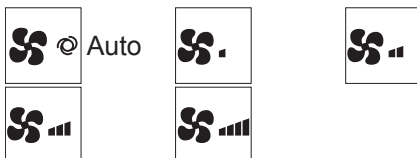

- The available fan speeds depend on the models of connected indoor units.

Vane setting



(Sample screen on CITY MULTI)

Each pressing of the ▼ or ▲ button cycles through the following vane settings.

Select the desired setting.

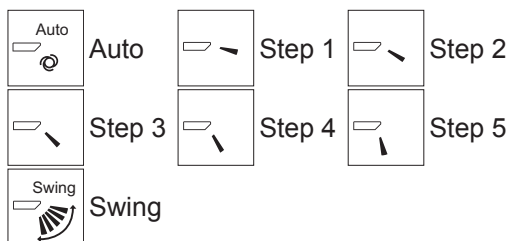

Select “Swing” to move the vanes up and down automatically.

When set to “Step 1” through “Step 5”, the vane will be fixed at the selected angle.

- **1h** at the left of the vane setting icon
This icon will appear when the vane is set to Step 2, 3, 4, or 5 and the fan operates at low speed during cooling or dry operation (depends on the model).
The icon will go off in an hour, and the vane setting will automatically change.

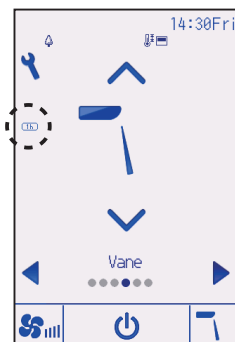

Louver setting

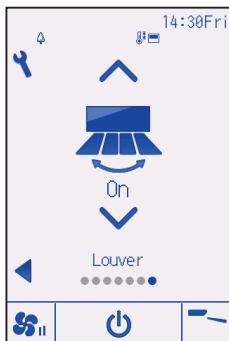

(Sample screen on CITY MULTI)

Press the ▼ or ▲ button to turn on or off the louver swing.



Ventilation setting

The ventilation setting can be made even when the units are in operation.

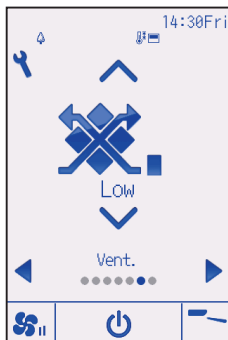

(Sample screen on Mr. SLIM)

Each pressing of the ▼ or ▲ button cycles through the following ventilation settings.

* Settable only when Lossnay unit is connected.



• The fan on some models of indoor units may be interlocked with certain models of ventilation units.

Navigating through the menu

Main menu list

Main menu	Setting items		Setting details	Page
Operation	High power		Use to reach the comfortable room temperature quickly. • Units can be operated in the High-power mode for up to 30 minutes.	25
	Comfort	Manual vane angle	Use to fix each vane angle.	26
Timer	Timer	On/Off timer	Use to set the operation On/Off times. • Time can be set in 5-minute increments. * Clock setting is required.	29
		Auto-Off timer	Use to set the Auto-Off time. • Time can be set to a value from 30 to 240 in 10-minute increments.	32
	Weekly timer		Use to set the weekly operation On/Off times. • Up to eight operation patterns can be set for each day. • Two types of weekly schedules can be set. * Clock setting is required. * Not valid when the On/Off timer is enabled. * 1°C increments	34
	OU silent mode		Use to set the time periods in which priority is given to quiet operation of outdoor units over temperature control. Set the Start/Stop times for each day of the week. • Select the desired silent level from "Normal," "Middle," and "Quiet." * Clock setting is required.	37
	Night setback		Use to make Night setback settings. • Select "Yes" to enable the setting, and "No" to disable the setting. The temperature range and the start/stop times can be set. * Clock setting is required. * 1°C increments	40
Energy saving	Restriction	Temp. range	Use to restrict the preset temperature range. • Different temperature ranges can be set for different operation modes. * 1°C increments	43
		Operation locked	Use to lock selected functions. • The locked functions cannot be operated.	46
	Energy saving	Auto return	Use to get the units to operate at the preset temperature after performing energy-save operation for a specified time period. • Time can be set to a value from 30 and 120 in 10-minute increments. * This function will not be valid when the preset temperature ranges are restricted. * 1°C increments	49

Main menu	Setting items		Setting details	Page
Energy saving	Energy saving	Schedule	<p>Set the start/stop times to operate the units in the energy-save mode for each day of the week, and set the energy-saving rate.</p> <ul style="list-style-type: none"> Up to four energy-save operation patterns can be set for each day. Time can be set in 5-minute increments. Energy-saving rate can be set to a value from 0% and 50 to 90% in 10% increments. <p>* Clock setting is required.</p>	51
Initial setting	Basic setting	Clock	Use to set the current time.	54
		Daylight saving time	Sets the daylight saving time.	56
	Display setting	Main display	Use to switch between "Full" and "Basic" modes for the Status display and the Main display. • The default setting is "Full."	58
		Brightness	Use to adjust screen brightness.	61
		Language selection	Use to select the desired language.	62
		Design	Use to change the color of the Status display and Main display.	64
	Touch panel	Touch panel calibration	Sets the calibration settings for the touch panel.	66
		Touch panel cleaning	Temporarily makes the touch panel unresponsive to touch to allow for cleaning.	68
Service	Initialize remote controller		Use to initialize the remote controller to the factory shipment status.	70
	Remote controller information		Use to display the remote controller model name, software version, and serial number.	72
Maintenance	Error information		<p>Use to check error information when an error occurs.</p> <ul style="list-style-type: none"> Error code, error source, refrigerant address, unit model, manufacturing number, contact information (dealer's phone number) can be displayed. <p>* The unit model, manufacturing number, and contact information need to be registered in advance to be displayed.</p>	74
	Filter information		<p>Use to check the filter status.</p> <ul style="list-style-type: none"> The filter sign can be reset. 	78

Navigating through the menu

Navigating through the Main menu

Button operation

Accessing the Main menu



Press the **[Setting]** button on the Main display.

The Main menu will appear.

Item selection

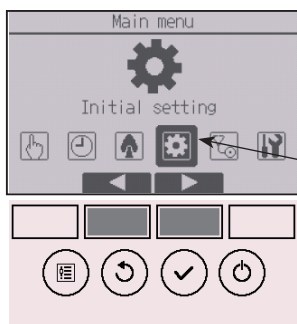

Press **[F2]** to move the cursor left.

Press **[F3]** to move the cursor right.

Function settings

High power



Function description

High-power operation function allows the units to operate at higher-than-normal capacity so that the room air can be conditioned to an optimum temperature quickly. This operation will last for up to 30 minutes, and the unit will return to the normal operation mode at the end of the 30 minutes or when the room temperature reaches the preset temperature, whichever is earlier. The units will return to the normal operation when the operation mode or fan speed is changed.

Button operation

1



Select “High power” from the Operation menu during Cooling, Heating, or Auto operation, and press the **SELECT** button.

“High power” function is available only on the models that support the function.

2



Move the cursor to “Yes” with the **F3** or **F4** button, and press the **SELECT** button.

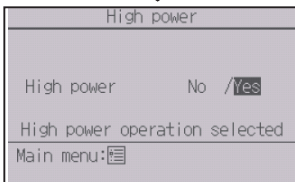

A confirmation screen will appear.

Navigating through the screens

- To go back to the Main menu **MENU** button
- To return to the previous screen **RETURN** button

Function settings

Manual vane angle

OFF

Button operation

1



Select “Comfort” from the Operation menu, and press the **[SELECT]** button.

2

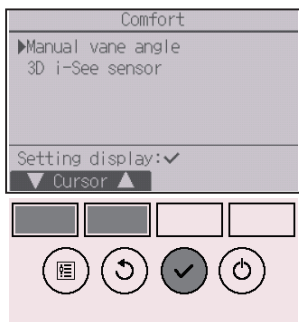

Select “Manual vane angle” with the **[F1]** or **[F2]** button, and press the **[SELECT]** button.

3



Move the cursor to “Ref. address” or “Unit No.” with the **[F1]** button to select.

Select the refrigerant address and the unit number for the units to whose vanes are to be fixed, with the **[F2]** or **[F3]** button, and press the **[SELECT]** button.

- Ref. address: Refrigerant address
- Unit No.: 1, 2, 3, 4

Press the **[F4]** button to confirm the unit.

The screen at left shows a sample display on Mr. SLIM. On CITY MULTI units, “M-NET address” is displayed instead of “Ref. address”, and the “Unit No.” will not be displayed.

4

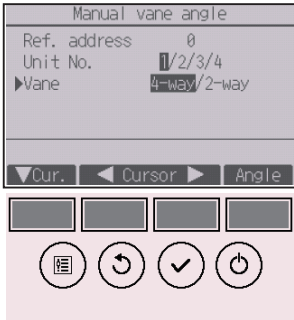

Select “Vane” with the **[F1]** button.

Select “4-way” or “2-way” with the **[F2]** or **[F3]** button, and press the **[F4]** button.

Function settings

5

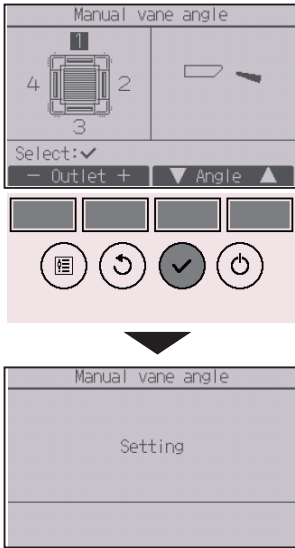

The current vane setting will appear.

Select the desired outlets from “1,” “2,” “3,” “4,” or “1, 2, 3, 4 (all outlets)” with the [F1] or [F2] button.

Press the [F3] or [F4] button to go through the following options and select the desired setting.

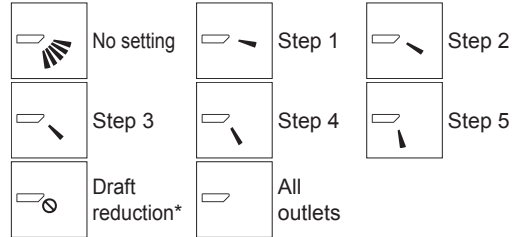

Press the [SELECT] button to save the settings.

A screen will appear that indicates the setting information is being transmitted.

The setting changes will be made to the selected outlet.

The screen will automatically return to the previous screen when the transmission is completed.

Make the settings for other outlets, following the same procedures.

If all outlets are selected,  will be displayed the next time the unit goes into operation.

Navigating through the screens

- To return to the previous screen [RETURN] button

*Draft reduction

The [Draft reduction] mode keeps the vane angle more horizontal than the angle of Step 1 so that the airflow will not be directed toward the people.

This function can be set only for one outlet.

This function cannot be set for models with two or three outlets.

In the Draft reduction mode, the airflow may cause the ceiling discoloration.

Timer (On/Off timer)



Button operation

1

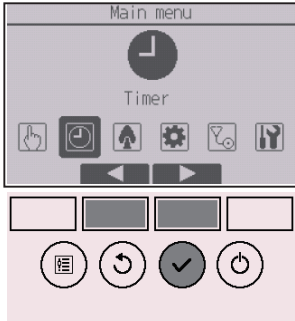

Select "Timer" from the Main menu (refer to page 24), and press the **SELECT** button.

The On/Off timer will not work in the following cases:

when On/Off timer is disabled, during an error, during check (in the service menu), during test run, during remote controller diagnosis, when the clock is not set, during function setting, when the system is centrally controlled (when On/Off operation or timer operation from local remote controller is prohibited).

2



Move the cursor to "Timer," and press the **SELECT** button.

3

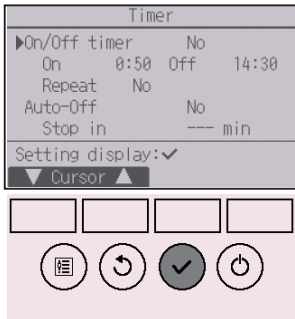

The current settings will appear.

Move the cursor to "On/Off timer," and press the **SELECT** button.

Function settings

4

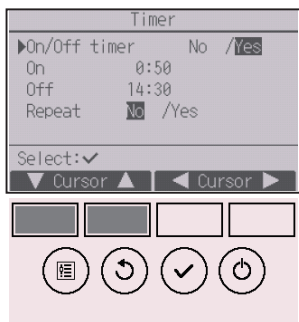

The screen to set the timer will appear.

Select the desired item with the **[F1]** or **[F2]** button out of “On/Off timer,” “On,” “Off,” or “Repeat.”

5

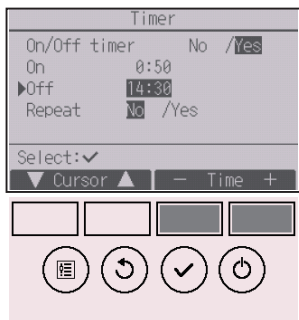

Change the setting with the **[F3]** or **[F4]** button.

- On/Off timer: No (disable)/Yes (enable)
- On: Operation start time
(settable in 5-minute increments)
 - * Press and hold the button to rapidly advance the numbers.
- Off: Operation stop time
(settable in 5-minute increments)
 - * Press and hold the button to rapidly advance the numbers.
- Repeat: No (once)/Yes (repeat)

6



Press the **[SELECT]** button to save the settings.





A confirmation screen will appear.

Navigating through the screens

- To go back to the Main menu **[MENU]** button
- To return to the previous screen **[RETURN]** button



 will appear on the Status display and the Main display in the Full mode when the On/Off timer is enabled.

 appears when the timer is disabled by the centralized control system.

Function settings

Timer (Auto-Off timer)



Button operation

1

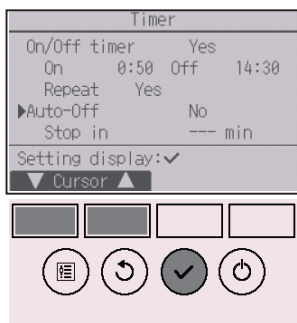

Bring up the Timer setting screen.
(Refer to page 29.)

Select "Auto-Off", and press the **[SELECT]** button.

The Auto-Off timer will not work in the following cases:

when Auto-Off timer is disabled, during an error, during check (in the service menu), during test run, during remote controller diagnosis, during function setting, when the system is centrally controlled (when On/Off operation or timer operation from local controller is prohibited).

2



The current settings will appear.

Move the cursor to "Auto-Off" or "Stop in --- min" with the **[F1]** or **[F2]** button.

3



Change the setting with the **[F3]** or **[F4]** button.

- Auto-Off: No (disable)/Yes (enable)
- Stop in --- min: Timer setting (The settable range is 30 to 240 minutes in 10-minute increments.)

4



Press the **SELECT** button to save the settings.

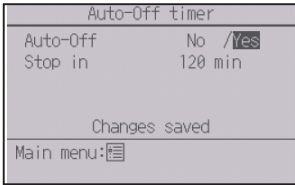



A confirmation screen will appear.

Navigating through the screens

- To go back to the Main menu **MENU** button
- To return to the previous screen **RETURN** button



 will appear on the Status display and the Main display in the Full mode when the Auto-Off timer is enabled.

 appears when the timer is disabled by the centralized control system.

Function settings

Weekly timer



Button operation

1



Select “Weekly timer” from the Timer menu, and press the **[SELECT]** button.

The Weekly timer will not work in the following cases:

when the On/Off timer is enabled, when the weekly timer is disabled, during an error, during check (in the service menu), during test run, during remote controller diagnosis, when the clock is not set, during function setting, when the system is centrally controlled (On/Off operation, temperature setting, or timer operation from local remote controller is prohibited).

2

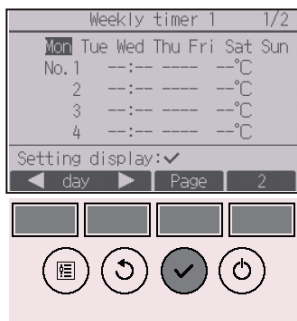

The current settings will appear.

Press the **[F1]** or **[F2]** button to see the settings for each day of the week.

Press the **[F3]** button to see patterns 5 through 8.

Press the **[F4]** button to display the status of Setting 2.

Press the **[SELECT]** button to go to the setting screen.

3



The weekly timer settings screen will appear.

In the “Action” setting, select “1” to enable the timer setting 1, or select “2” to enable the timer setting 2 with the **[F3]** or **[F4]** button. Then, press the **[SELECT]** button.

To check the setting contents of the timer setting 1 or 2, move the cursor to “Setting” with the **[F1]** or **[F2]** button, and select “1” or “2” with the **[F3]** or **[F4]** button.

4

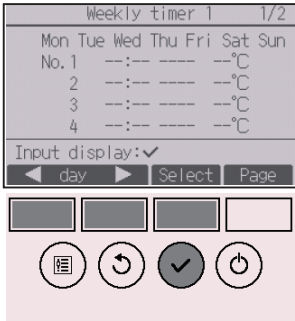

The weekly timer setting screen will appear and the current settings will be displayed.

Up to eight operation patterns can be set for each day.

Move the cursor to the desired day of the week with the **[F1]** or **[F2]** button, and press the **[F3]** button to select it. (Multiple days can be selected.)

Press the **[SELECT]** button.

Function settings

5

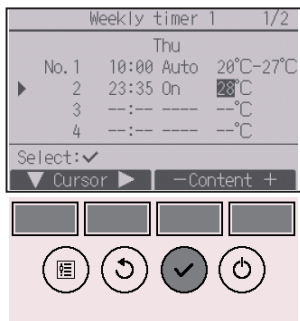

Operation pattern setting screen will appear.

Press the **[F1]** button to move the cursor to the desired pattern number.

Move the cursor to the time, On/Off, or temperature with the **[F2]** button.

Change the settings with the **[F3]** or **[F4]** button.

- Time: settable in 5-minute increments
 - * Press and hold the button to rapidly advance the numbers.
- On/Off/Auto: Selectable settings depend on the model of connected indoor unit. (When an Auto pattern is executed, the system will operate in the Auto (dual set point) mode.)
- Temperature: The settable temperature range depends on the connected indoor units. (1°C increments)
 - When the Auto (dual set point) mode is selected, two preset temperatures can be set. If an operation pattern with a single preset temperature setting is executed during the Auto (dual set point) mode, its setting will be used as the cooling temperature setting in the Cool mode.

Press the **[SELECT]** button to save the settings.

A confirmation screen will appear.

Navigating through the screens

- To go back to the setting change/day of the week selection screen **[SELECT]** button
- To go back to the Main menu **[MENU]** button
- To return to the previous screen **[RETURN]** button



 will appear on the Status display and the Main display in the Full mode when the weekly timer setting for the current day exists.

The icon will not appear while the On/Off timer is enabled or the system is under centralized control (Timer operation from local remote controller is prohibited).

OU silent mode



Function description

This function allows the user to set the time periods in which priority is given to quiet operation of outdoor units over temperature control. Set the start and stop times each day of the week for the quiet operation. Select the desired silent level from “Middle” and “Quiet”.

Button operation

1



Select “OU silent mode” from the Timer menu, and press the **SELECT** button.

“OU silent mode” function is available only on the models that support the function.

2

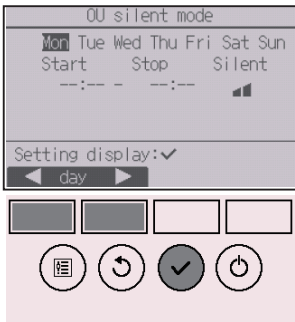

The current settings will appear.

Press the **F1** or **F2** button to see the settings for each day of the week.

Press the **SELECT** button to go to the setting screen.

Function settings

3



The screen to enable (Yes) and disable (No) the silent mode will appear.

To enable this setting, move the cursor to “Yes” with the **[F3]** or **[F4]** button, and press the **[SELECT]** button .

4

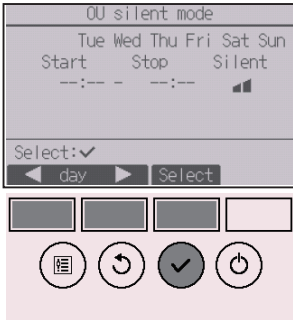

The OU silent mode setting screen will appear.

To make or change the setting, move the cursor to the desired day of the week with the **[F1]** or **[F2]** button, and press the **[F3]** button to select it. (Multiple days can be selected.)

Press the **[SELECT]** button.

5

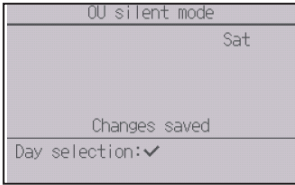
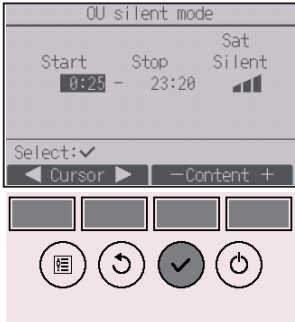

The setting screen will appear.

Move the cursor to the desired item with the **[F1]** or **[F2]** button out of Start time, Stop time, or Silent level.

Change the settings with the **[F3]** or **[F4]** button.

- Start/Stop time: settable in 5-minute increments
 - * Press and hold the button to rapidly advance the numbers.
- Silent level: Normal, Middle, Quiet



Press the **[SELECT]** button to save the settings. A confirmation screen will appear.

Navigating through the screens

- To go back to the setting change/day of the week selection screen **[SELECT]** button
- To go back to the Main menu **[MENU]** button
- To return to the previous screen **[RETURN]** button



 will appear on the Status display and the Main display in the Full mode during the OU silent mode.

Function settings

Night setback



Function description

This control starts heating operation when the control object group is stopped and the room temperature drops below the preset lower limit temperature. Also, this control starts cooling operation when the control object group is stopped and the room temperature rises above the preset upper limit temperature.

The Night setback function is not available if the operation and the temperature setting are performed from the remote controller.

If the room temperature is measured by the air-conditioner's suction temperature sensor, the accurate temperature may not be obtained when the air-conditioner is inactive or when the air is not clean. In this case, switch the sensor to a remote sensor (PAC-SE40TSA/PAC-SE41TS-E) or a remote control sensor.

Button operation

1



Select "Night setback" from the Timer menu, and press the **SELECT** button.

2



The current settings will appear.

Press the **SELECT** button to go to the setting screen.

3



Move the cursor to the desired item with the **[F1]** or **[F2]** button out of Night setback No (disable)/Yes (enable), Temp. range, Start time, or Stop time.

Change the settings with the **[F3]** or **[F4]** button.

- Temp. range: The lower limit temperature (for heating operation) and the upper limit temperature (for cooling operation) can be set. The temperature difference between the lower and upper limits must be 4°C (8°F) or more. The settable temperature range varies depending on the connected indoor units.
* 1°C increments
- Start/Stop time: settable in 5-minute increments
* Press and hold the button to rapidly advance the numbers.

Press the **[SELECT]** button to save the settings. A confirmation screen will appear.

Navigating through the screens

- To go back to the Main menu **[MENU]** button
- To return to the previous screen **[RETURN]** button

Function settings



 will appear on the Status display and the Main display in the Full mode when the Night setback function is enabled.

 appears when the timer is disabled by the centralized control system.

The Night setback will not work in the following cases:

when the unit is in operation, when the Night setback function is disabled, during an error, during check (in the service menu), during test run, during remote controller diagnosis, when the clock is not set, during function setting, when the system is centrally controlled (On/Off operation, temperature setting, or timer operation from local remote controller is prohibited).

Setting the temperature range restriction

Button operation

1

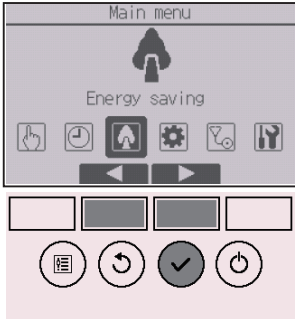

Select "Energy saving" from the Main menu (refer to page 24), and press the **SELECT** button.

2

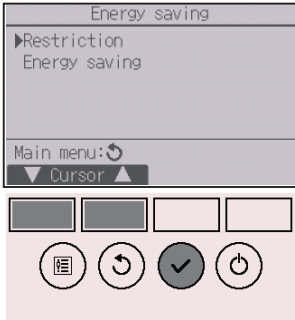

Move the cursor to "Restriction" with the **F1** or **F2** button, and press the **SELECT** button.

Function settings

3

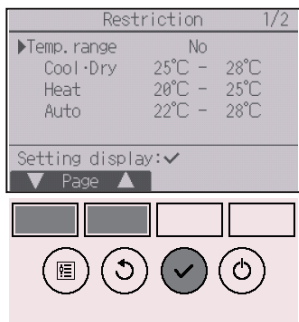

The current settings will appear.

Move the cursor to “Temp. range” with the **F1** or **F2** button, and press the **SELECT** button.

4

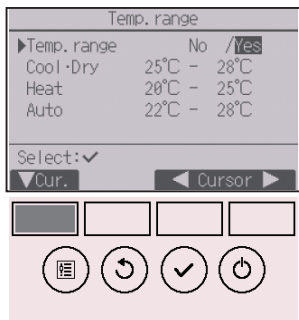

The screen to set the temperature range will appear.

Move the cursor to the desired item with the **F1** button out of “Temp. range,” “Cool-Dry,” “Heat,” or “Auto.”

5

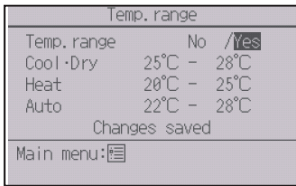
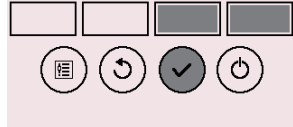
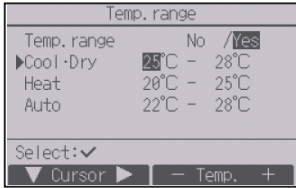

Change the settings with the **[F3]** or **[F4]** button.

- Temp. range: No (unrestricted) or Yes (restricted)
- Cool-Dry: Upper and lower limit temperature (1°C increments)
- Heat: Upper and lower limit temperature (1°C increments)
- Auto: Upper and lower limit temperature (1°C increments)

Temperature setting ranges

Mode		Lower limit	Upper limit
Cool+Dry	*1	19 ~ 30°C	30 ~ 19°C
	*3	(67 ~ 87°F)	(87 ~ 67°F)
Heat	*2	17 ~ 28°C	28 ~ 17°C
	*3	(63 ~ 83°F)	(83 ~ 63°F)
Auto	*4	19 ~ 28°C	28 ~ 19°C
		(67 ~ 83°F)	(83 ~ 67°F)

* The settable range varies depending on the connected unit.

*1 Temperature ranges for the Cool, Dry, and Auto (dual set point) modes can be set.

*2 Temperature ranges for the Heat and Auto (dual set point) modes can be set.

*3 Temperature ranges for the Heat, Cool, and Dry modes must meet the conditions below:

- Upper limit for cooling - upper limit for heating \geq Minimum temperature difference (varies with indoor unit model)
- Lower limit for cooling - lower limit for heating \geq Minimum temperature difference (varies with indoor unit model)

*4 Temperature range for the Auto (single set point) mode can be set.

Press the **[SELECT]** button to save the settings.

A confirmation screen will appear.

Navigating through the screens

- To go back to the Main menu **[MENU]** button
- To return to the previous screen **[RETURN]** button



 will appear on the Status display and the Main display in the Full mode when the temperature range is restricted.

Function settings

Restriction

P

Operation lock function

Button operation

To enable the operation lock function, set the item "Operation locked" to "Yes".

1

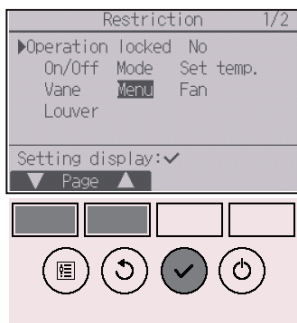

Bring up the Restriction setting screen. (Refer to page 43.)

Move the cursor to "Operation locked" and press the **SELECT** button.

2

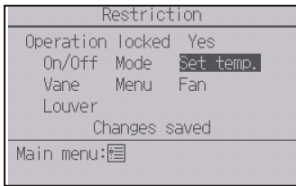

The screen to make the settings for the operation lock function will appear.

Move the cursor to the desired item with the **[F1]** or **[F2]** button out of “Operation locked,” “Location,” “On/Off,” “Mode,” “Set temp.,” “Menu,” “Fan,” “Louver,” or “Vane.”

Change the settings with the **[F3]** or **[F4]** button.

- Operation locked: No (disable)/Yes (enable)
- Location: “Individual” or “Hotel”
- On/Off: On/Off operation
- Mode: Operation mode setting
- Set temp.: Preset temp. setting
- Vane: Vane setting
- Menu: Menu setting
- Fan: Fan speed setting
- Louver: Louver setting

“-” / “Locked”

When “Hotel” is selected for the “Location” setting, the following operations will be locked automatically: Mode, Vane, Menu, and Louver.

Press the **[SELECT]** button to save the settings. A confirmation screen will appear.

Navigating through the screens

- To go back to the Main menu **[MENU]** button
- To return to the previous screen **[RETURN]** button

Function settings



 will appear on the Status display and the Main display in the Full mode when the operation lock function setting is enabled.

Operation guide that corresponds to the locked function will be suppressed.

To display the main menu while the menu setting is being locked, press and hold the **Setting** button for ten or more seconds. Enter the administrator's password on the password input screen.

Automatic return to the preset temperature

After the Auto return function is enabled, when the operation mode change or ON/OFF operation is performed from this remote controller, the set temperature automatically returns to the required temperature regardless of the set time.

Button operation

1

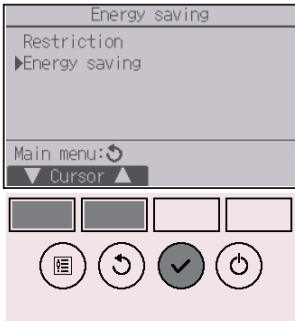

Select “Energy saving” from the Energy saving menu, and press the **[SELECT]** button.

2



The current settings will appear.

Move the cursor to “Auto return” with the **[F1]** or **[F2]** button, and press the **[SELECT]** button.

Function settings

3



The screen to make the settings for the automatic return to the preset temperature will appear.

Move the cursor to the desired item with the **[F1]** or **[F2]** button out of “Auto return,” “Cool,” or “Heat.”

4

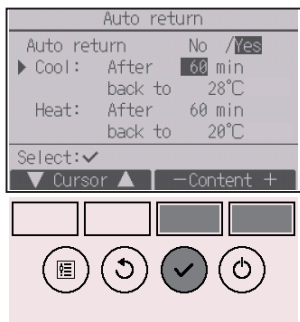

Change the settings with the **[F3]** or **[F4]** button.

- Auto return: No (disable)/Yes (enable)
- Cool: Timer setting range is 30 to 120 minutes in 10-minute increments.
Temperature setting range is 19 to 30°C (67 to 87°F) (1°C increments).
- Heat: Timer setting range is 30 to 120 minutes in 10-minute increments.
Temperature setting range is 17 to 28°C (63 to 83°F) (1°C increments).

Press the **[SELECT]** button to save the settings. “Cool” includes “Dry” and “Auto Cool” modes, and “Heat” includes “Auto Heat” mode.

The screen to set the selected item will appear.

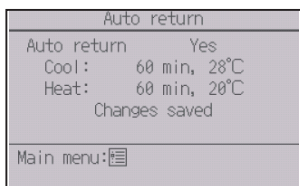

Navigating through the screens

- To go back to the Main menu **[MENU]** button
- To return to the previous screen **[RETURN]** button

Timer or preset temperature settings will not be effective when the temperature range is restricted and when the system is centrally controlled (when the temperature range setting from local controller is prohibited). When the system is centrally controlled (when timer operation from local remote controller is prohibited), only the timer setting will be ineffective.

Setting the energy-saving operation schedule

Button operation

1

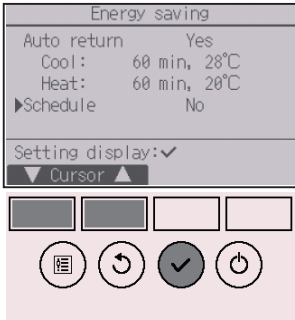

Bring up the “Energy saving” screen. (Refer to page 49.)

Move the cursor to “Schedule,” and press the **SELECT** button.

2

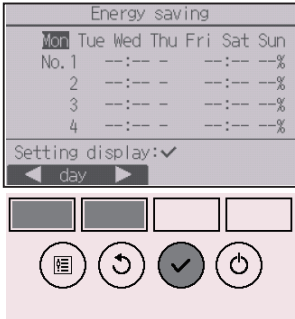

The screen to see the schedule will appear.

Press the **F1** or **F2** button to see the settings for each day of the week.

Press the **SELECT** button to go to the setting screen.

3

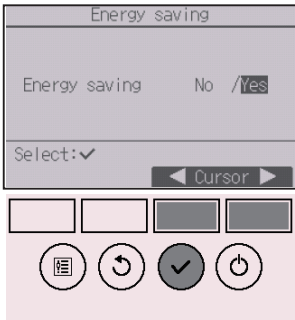

The screen to enable (Yes)/disable (No) the energy-saving operation schedule will appear.

Select “No” or “Yes” with the **F3** or **F4** button.

Press the **SELECT** button to go to the setting change/day of the week selection screen.

Function settings

4

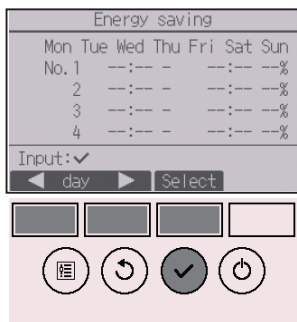

The setting change/day of the week selection screen will appear.

Up to four operation patterns can be set for each day. Move the cursor to the desired day of the week with the **[F1]** or **[F2]** button, and press the **[F3]** button to select it. (Multiple days can be selected.)

Press the **[SELECT]** button to go to the pattern setting screen.

5

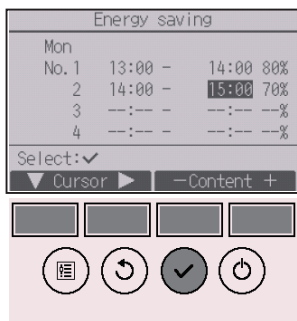

The pattern setting screen will appear.

Press the **[F1]** button to move the cursor to the desired pattern number.

Move the cursor to the desired item with the **[F2]** button out of the start time, stop time, and energy-saving rate (arranged in this order from the left).

Change the settings with the **[F3]** or **[F4]** button.

- Start/Stop time: settable in 5-minute increments
 - * Press and hold the button to rapidly advance the numbers.
- Energy-saving rate: The setting range is 0% and 50 to 90% in 10% increments.

Press the **[SELECT]** button to save the settings. A confirmation screen will appear.

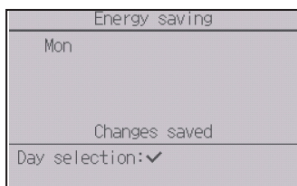

The lower the value, the greater the energy-saving effect.



 will appear on the Status display and the Main display in the Full mode when the unit is operated in the energy saving mode.

Navigating through the screens

- To go back to the setting change/day of the week selection screen **SELECT** button
- To go back to the Main menu **MENU** button
- To return to the previous screen **RETURN** button

Function settings

Clock

P

Button operation

1

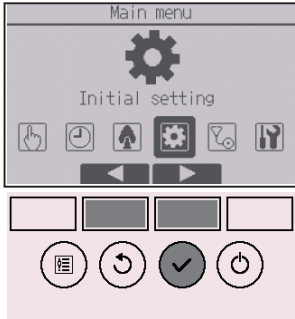

Select "Initial setting" from the Main menu (refer to page 24), and press the **[SELECT]** button.

Clock setting is required before making the following settings.

- On/Off timer
- Weekly timer
- OU silent mode
- Energy saving
- Night setback

If a given system has no system controllers, the clock time will not automatically be corrected. In this case, periodically correct the clock time.

2



Move the cursor to "Basic setting" with the **[F1]** or **[F2]** button, and press the **[SELECT]** button.

3

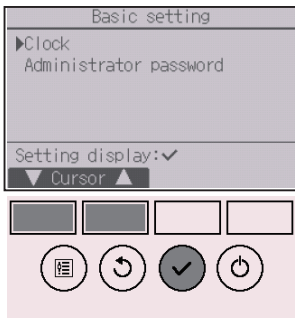

Select "Clock" with the **[F1]** or **[F2]** button, and press the **[SELECT]** button.

4



Move the cursor to “Clock” with the **F1** or **F2** button, and press the **SELECT** button.

5



Move the cursor to the desired item with the **F1** or **F2** button out of year, month, date, hour, or minute. Increase or decrease the value for the selected item with the **F3** or **F4** button, and press the **SELECT** button.

A confirmation screen will appear.

Navigating through the screens

- To go back to the Main menu **MENU** button
- To return to the previous screen **RETURN** button

Function settings

Daylight saving time



Function description

The start/end time for daylight saving time can be set. The daylight saving time function will be activated based on the setting contents.

- If a given system has a system controller, disable this setting to keep the correct time.
- At the beginning and the end of daylight saving time, the timer may go into action twice or not at all.
- This function will not work unless the clock has been set.

Button operation

1

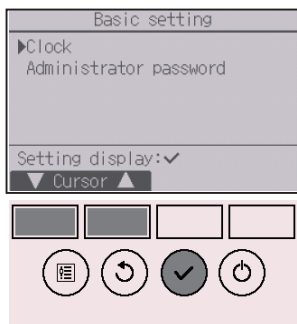

Select “Clock” from the Basic setting menu, and press the **[SELECT]** button.

2



Move the cursor to “Daylight saving time” with the **[F1]** or **[F2]** button, and press the **[SELECT]** button.

3

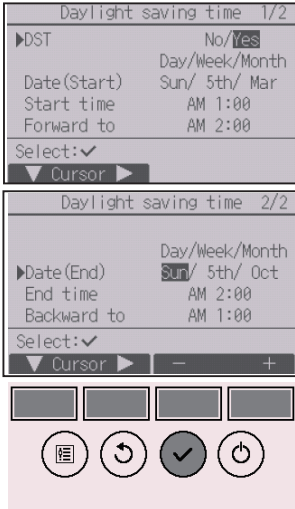

Move the cursor to the following items with the **[F1]** button to make the settings.

- **DST**
Select “No” (disable) or “Yes” (enable) with the **[F2]** button. The default setting is “No.”
- **Date(Start)*1**
Set the day of the week, week number, and month with the **[F3]** or **[F4]** button. The default setting is “Sun/5th/Mar.”
- **Start time**
Set the start time for daylight saving time with the **[F3]** or **[F4]** button.
- **Forward to**
Set the time when the clock is to be set forward to at the start time above with the **[F3]** or **[F4]** button.
- **Date(End)*1 (2nd page)**
Set the day of the week, week number, and month with the **[F3]** or **[F4]** button. The default setting is “Sun/5th/Oct.”
- **End time (2nd page)**
Set the end time for daylight saving time with the **[F3]** or **[F4]** button.
- **Backward to (2nd page)**
Set the time when the clock is to be set backward to at the end time above with the **[F3]** or **[F4]** button.

*1 If “5th” is selected for the week number and the 5th week does not exist in the selected month of the year, the setting is considered to be “4th.”

Press the **[SELECT]** button to save the settings. A confirmation screen will appear.

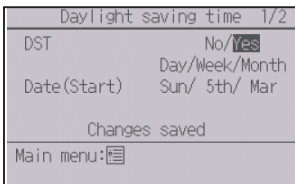

Navigating through the screens

- To go back to the Main menu **[MENU]** button
- To return to the previous screen **[RETURN]** button

Function settings

Main display



Button operation

1



Select “Display setting” from the Initial setting menu, and press the **[SELECT]** button.

2



Move the cursor to “Main display” with the **[F1]** or **[F2]** button, and press the **[SELECT]** button.

3

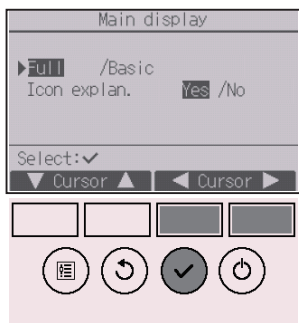

Select “Full” or “Basic” (refer to page 10) with the **[F3]** or **[F4]** button, and press the **[SELECT]** button.

A confirmation screen will appear.

Navigating through the screens

- To go back to the Main menu **[MENU]** button
- To return to the previous screen **[RETURN]** button

Button operation

1



Select “Display setting” from the Initial setting menu, and press the **[SELECT]** button.

2

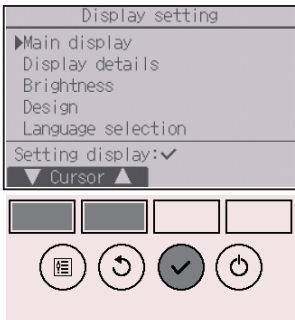

Move the cursor to “Main display” with the **[F1]** or **[F2]** button, and press the **[SELECT]** button.

3

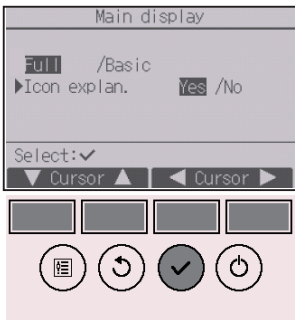

Select “Icon explan.” with the **[F1]** or **[F2]** button, select the desired setting “Yes” or “No” with the **[F3]** or **[F4]** button, and press the **[SELECT]** button. The default setting is “Yes”.

Navigating through the screens

- To go back to the Main menu **[MENU]** button
- To return to the previous screen **[RETURN]** button

Function settings

4

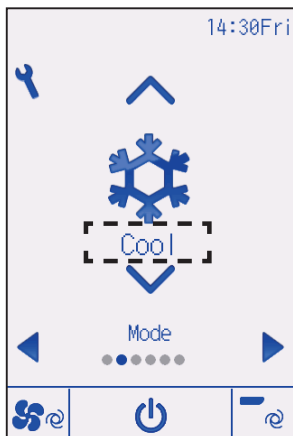

When “Yes” is selected, the explanation of the icon of the setting item will appear as shown at left.

Button operation

1



Select “Display setting” from the Initial setting menu, and press the **[SELECT]** button.

2

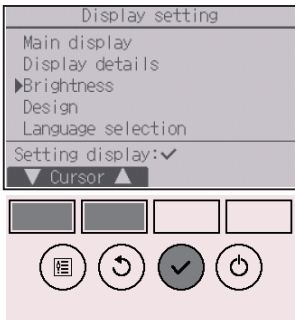

Move the cursor to “Brightness” with the **[F1]** or **[F2]** button, and press the **[SELECT]** button.

3



Adjust the brightness with the **[F1]** or **[F2]** button. “ON” or “OFF” can be selected for the “Stay lit” setting with the **[F4]** button.

When “ON” is selected, the backlight will remain lit dimly even after the specified time has elapsed.

Navigating through the screens

- To go back to the Main menu **[MENU]** button
- To return to the previous screen **[RETURN]** button

Function settings

Language selection



Function description

The desired language can be set. The language options are English, French, German, Spanish, Italian, Portuguese, Swedish, Russian, Greek, Turkish, Dutch, Czech, Hungarian, and Polish.

Button operation

1



Select “Display setting” from the Initial setting menu, and press the **SELECT** button.

2

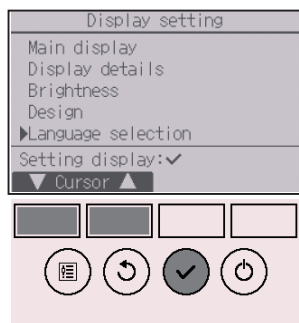

Move the cursor to “Language selection” with the **F1** or **F2** button, and press the **SELECT** button.

3

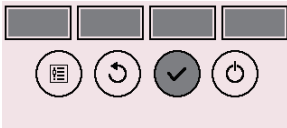
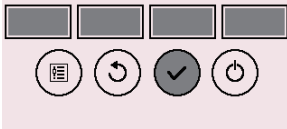

Move the cursor to the language you desire with the **F1** through **F4** buttons, and press the **SELECT** button to save the setting.

When the power is on for the first time, the Language selection screen will be displayed. Select a desired language. The system will not start-up without language selection.

A screen will appear that indicates the setting has been saved.

Navigating through the screens

- To go back to the Main menu **MENU** button
- To return to the previous screen **RETURN** button

Function settings

Design



Button operation

1



Select “Display setting” from the Initial setting menu, and press the **[SELECT]** button.

2

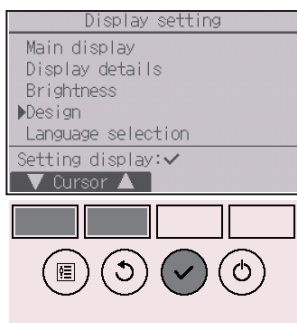

Move the cursor to “Design” with the **[F1]** or **[F2]** button, and press the **[SELECT]** button.

3



Select “Color” with the **[F4]** button.

- Color: The display color can be selected. (Refer to the next page.)
- White: Monochrome display (white basis)
- Black: Monochrome display (black basis)

When “White” or “Black” is selected, press the **[SELECT]** button. When “Color” is selected, select the desired color referring to the next page.

4



Select the following item with the **[F1]** or **[F2]** button, and set the desired display color for each item.

- Color shade: Set the color shade with the **[F3]** or **[F4]** button. (The settable range is -90 to 89.)
- Pattern: Set the color with the **[F4]** button.
- Color set to: Select "Character" or "BG" (Background) as a target to which the color is applied with the **[F4]** button.

The sample color below the function buttons will change according to the setting.



Set the desired color, and press the **[SELECT]** button.

Navigating through the screens

- To go back to the Main menu **[MENU]** button
- To return to the previous screen **[RETURN]** button

Function settings

Touch panel calibration



Button operation

1



Select “Touch panel” from the Initial setting menu, and press the **SELECT** button.

2



Move the cursor to “Touch panel calibration” with the **F1** or **F2** button, and press the **SELECT** button.

3



A confirmation screen will appear. Select “Cancel” or “OK” with the **F3** or **F4** button, and press the **SELECT** button.

4

Touch the black dots in the order they appear on the screen. There will be nine of them all together.

Touch the black dots with a touch pen in a minute, starting from the topleft corner.

Touch the nine black dots in the order they appear on the screen.

When all nine black dots are touched, the calibration is complete, and the display will return to the touch panel menu.

- If the touch panel is left untouched for one minute, the calibration will be canceled and the display will automatically return to the previous screen.
- To properly calibrate the touch panel, use a pointy but not sharp object to touch the dots.
 - * A sharp object may damage or scratch the touch panel.

Function settings

Touch panel cleaning



Button operation

1

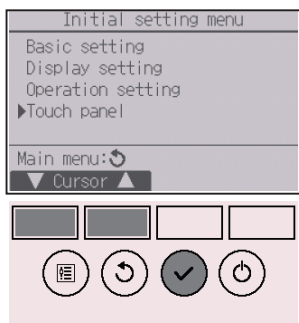

Select “Touch panel” from the Initial setting menu, and press the **SELECT** button.

2



Move the cursor to “Touch panel cleaning” with the **F1** or **F2** button, and press the **SELECT** button.

3



A confirmation screen will appear. Select “Cancel” or “OK” with the **F3** or **F4** button, and press the **SELECT** button.

4

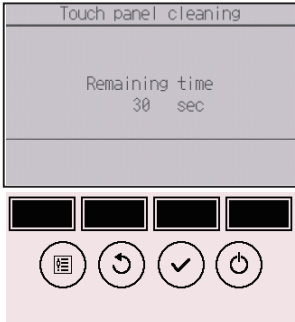

This screen allows the user to wipe the touch panel for 30 seconds without accidentally changing the settings.

The display will return to the touch panel menu after the 30 seconds.

- Wipe with a soft dry cloth, a cloth soaked in water with mild detergent, or a cloth dampened with ethanol. Do not use acidic, alkaline, or organic solvents.

Function settings

Initialize remote controller



Function description

The remote controller can be initialized to the factory shipment state. Note that the following data will be initialized.

The remote controller will automatically be started up after being initialized.

Timer setting, Weekly timer setting, OU silent mode setting, Energy saving setting, Energy saving option setting, Clock setting, Daylight saving time setting, Main display setting, Brightness setting, Display details setting, Design setting, Auto mode setting, Model name setting, Serial No. setting, Dealer information setting, Error information, Administrator password, Maintenance password

Button operation

1

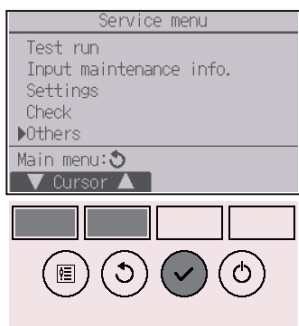

Select “Others” from the Service menu, and press the **SELECT** button.

2



Move the cursor to “Initialize remote controller” with the **F1** or **F2** button, and press the **SELECT** button.

3

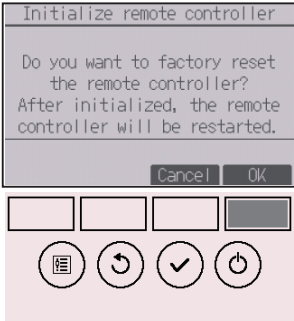

Select "OK" with the **[F4]** button.

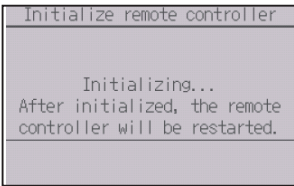

The remote controller will automatically be started up after being initialized.

Function settings

Remote controller information



Function description

The information of the remote controller in use can be checked.

Button operation

1



Select “Others” from the Service menu, and press the **SELECT** button.

2



Move the cursor to “Remote controller information” with the **F1** or **F2** button, and press the **SELECT** button.

3

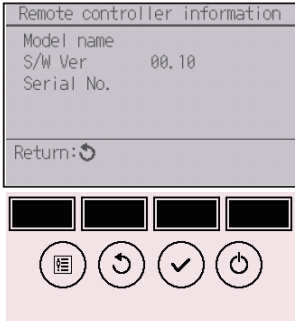

The model name, software version, and serial number of the remote controller in use can be checked.

Troubleshooting

Error information

When an error occurs, the following screen will appear and the operation LED will blink. Check the error status, stop the operation, and consult your dealer.

Button operation

1

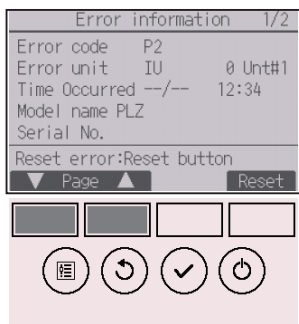

Error code, error unit, refrigerant address, unit model name, date and time on which an error occurred, and serial number will appear.

The model name and serial number will appear only if the information have been registered.

Press the **F1** or **F2** button to go to the next page.

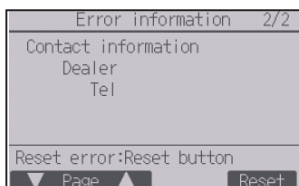

Contact information (dealer's phone number) will appear if the information have been registered.

2

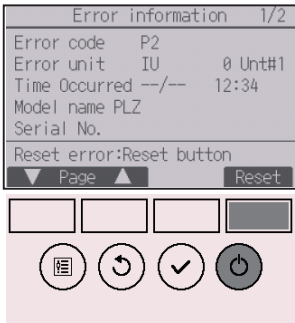

Press the **F4** button or the **ON/OFF** button to reset the error that is occurring.

Errors cannot be reset while the ON/OFF operation is prohibited.

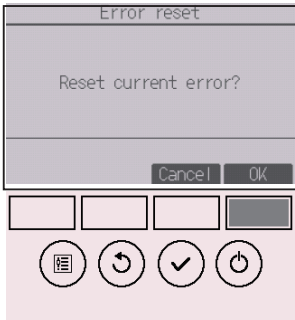

Select "OK" with the **F4** button.

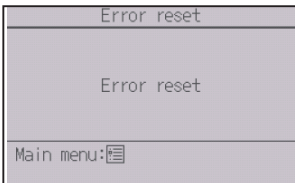

A confirmation screen will appear.

Navigating through the screens

- To go back to the Main menu **MENU** button

Troubleshooting

Checking the error information

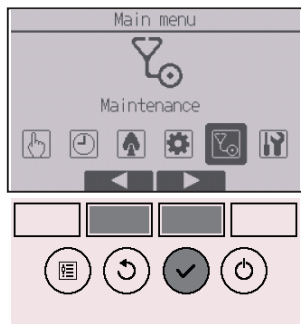

While no errors are occurring, page 2/2 of the error information (refer to page 74) can be viewed from the menu operation.

Select "Maintenance" menu from the Main menu, and press the **SELECT** button.

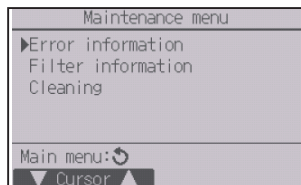

To display the error information screen, select "Error information" from the Maintenance menu. Errors cannot be reset.

No occupancy Auto-OFF

The following screen will appear for the 3D i-See sensor panel model when the unit is stopped due to the No occupancy Auto-OFF function of the energy saving option. Refer to the indoor unit Instruction Book for the 3D i-See sensor setting.

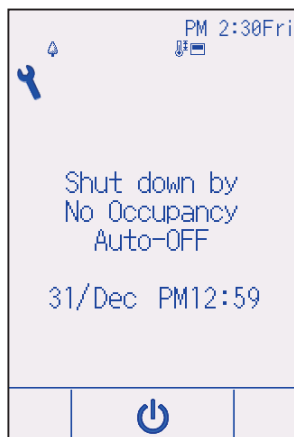

Maintenance

Filter information



 will appear on the Status display and the Main display in the Full mode when it is time to clean the filters.

Wash, clean, or replace the filters when this sign appears.

Refer to the indoor unit Instructions Manual for details.

Button operation

1

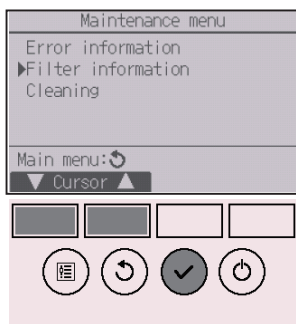

Select "Filter information" from the Maintenance menu, and press the **[SELECT]** button.

2



Press the **[F4]** button to reset filter sign.
Refer to the indoor unit Instructions Manual for how to clean the filter.

3



Select "OK" with the **[F4]** button.



A confirmation screen will appear.

Navigating through the screens

- To go back to the Main menu **[MENU]** button
- To return to the previous screen **[RETURN]** button



When the  is displayed on the Status display and the Main display in the Full mode, the system is centrally controlled and the filter sign cannot be reset.

If two or more indoor units are connected, filter cleaning timing for each unit may be different, depending on the filter type.

The icon  will appear when the filter on the main unit is due for cleaning.

When the filter sign is reset, the cumulative operation time of all units will be reset.

The icon  is scheduled to appear after a certain duration of operation, based on the premise that the indoor units are installed in a space with ordinary air quality. Depending on the air quality, the filter may require more frequent cleaning.

The cumulative time at which filter needs cleaning depends on the model.

Specifications

Controller specifications

	Specification
Product size	Standard (PAR-CT01MAA(R)-SB/PAR-CT01MAA-S): 65(W) × 120(H) × 14.1(D) mm (2 9/16 × 4 23/32 × 9/16 [in]) (not including the protruding part)
	Premium (PAR-CT01MAA(R)-PB): 68(W) × 120(H) × 14.1(D) mm (2 11/16 × 4 23/32 × 9/16 [in]) (not including the protruding part)
Net weight	Standard (PAR-CT01MAA(R)-SB/PAR-CT01MAA-S): 0.09 kg (13/64 lbs)
	Premium (PAR-CT01MAA(R)-PB): 0.10 kg (7/32 lbs)
Rated power supply voltage	12 VDC (supplied from indoor units)
Power consumption	0.6 W
Usage environment	Temperature 0 ~ 40°C (32 ~ 104°F) Humidity 25 ~ 90%RH (with no dew condensation)
Material	Standard (PAR-CT01MAA(R)-SB/PAR-CT01MAA-S) Main body: ABS
	Premium (PAR-CT01MAA(R)-PB) Main body: ABS Side plate: Aluminum

Function list (as of October 1, 2017)

○ : Supported × : Unsupported

	Function	CITY MULTI	Mr. SLIM	Required password
Power	Power ON/OFF	○	○	-
Settings	Operation mode	○	○	-
	Auto (dual set point) mode	○	○	-
	Preset temperature	○	○	-
	Fan speed	○	○	-
	Vane	○	○	-
	Louver	○	○	-
	Ventilation	○	○	-
Operation menu	High power	×	○	-
	Manual vane angle	○	○	-
	3D i-See sensor	○	○	-
Timer menu	Timer (On/Off timer)	○	○	administrator
	Timer (Auto-Off timer)	○	○	administrator
	Weekly timer	○	○	administrator
	OU silent mode	○	○	administrator
	Night setback	○	○	administrator
Energy saving menu	Temperature range restriction	○	○	administrator
	Operation lock function	○	○	administrator
	Auto return	○	○	administrator
	Schedule	×	○	administrator
Initial setting menu	Clock	○	○	administrator
	Clock display format setting	○	○	administrator
	Daylight saving time	○	○	administrator
	Main display	○	○	administrator
	Icon explanation	○	○	administrator
	Brightness	○	○	administrator
	Language selection	○	○	administrator
	Design	○	○	administrator
	Touch panel calibration	○	○	administrator
	Touch panel cleaning	○	○	administrator
Password (Administrator)	○	○	administrator	
Service menu	Initialize remote controller	○	○	maintenance
	Remote controller information	○	○	maintenance
	Test run	○	○	maintenance
	Model information input	○	○	maintenance
	Dealer information input	○	○	maintenance
	Function setting	○	○	maintenance
	Smooth maintenance	×	○	maintenance
	Password (Maintenance)	○	○	maintenance
Maintenance menu	Auto descending panel	○	○	-
	Error information	○	○	-
	Filter information	○	○	-

* The supported functions vary depending on the unit model.

Specifications

List of functions that can/cannot be used in combination

	High power	On/Off timer	Auto-off timer	Weekly timer	OU silent mode	Temperature range	Operation lock	Auto return	Energy saving schedule	Night setback
High power		○	○	○	△1	○	△2	○	△1	○
On/Off timer	○		○	×1	○	○	○	○	○	△3
Auto-off timer	○	○		○	○	○	○	○	○	△4
Weekly timer	○	×1	○		○	○	○	○	○	△5
OU silent mode	△1	○	○	○		○	○	○	○	○
Temperature range	○	○	○	○	○		○	×2	○	△6
Operation lock	△2	○	○	○	○	○		○	○	○
Auto return	○	○	○	○	○	×2	○		○	△7
Energy saving schedule	△1	○	○	○	○	○	○	○		○
Night setback	○	△3	△4	△5	○	△6	○	△7	○	

○ : Can be used in combination × : Cannot be used in combination △ : Restricted

△ 1: This function is enabled after completing the high power operation because the high power operation has the higher priority.

△ 2: This function cannot be operated if some operation is locked.

△ 3: Night setback function cannot be used when the unit is in operation by On/Off timer setting.

△ 4: Auto-off function cannot be used for Night setback operation.

△ 5: Night setback function cannot be used when the unit is in operation by Weekly timer setting.

△ 6: Temperature range setting cannot be used for Night setback operation.

△ 7: Auto return function cannot be used for Night setback operation.

× 1: Weekly timer setting is not effective because On/Off timer has the higher priority.

× 2: Auto return function cannot be used because Temperature range setting has the higher priority.

Système de contrôle CITY MULTI
et Climatiseurs Mitsubishi Mr. Slim

Télécommande tactile MA

PAR-CT01MAA-PB

PAR-CT01MAA-SB

PAR-CT01MAA-S

PAR-CT01MAR-PB

PAR-CT01MAR-SB

Manuel d'utilisation



Avant toute utilisation, lire attentivement les instructions de ce manuel pour utiliser le produit correctement.

Conservez-le pour vous y référer ultérieurement.

Assurez-vous que ce CD-ROM et le manuel d'installation sont bien remis à tout futur utilisateur.



Pour assurer la sécurité et le bon fonctionnement de la télécommande, elle doit être installée uniquement par du personnel qualifié.

Table des matières

Consignes de sécurité	4
Caractéristiques de la télécommande	6
Interface de la télécommande - Écran d'état/Écran principal de réglage	6
Interface de la télécommande - Écran du menu	8
Écran - Écran d'état/Écran principal de réglage	10
Structure et icônes des menus	12
Structure des menus	12
Explication des icônes	15
Opérations de base	16
Marche / Arrêt	16
Réglage de mode de fonctionnement, température, vitesse ventilateur, vanne, volet et ventilation (Lossnay).....	17
Naviguer dans le menu	22
Liste du Menu général	22
Naviguer dans le Menu général	24
Réglages des fonctions	25
Forte puissance	25
Angle de volet manuel	26
Timer (ON/OFF timer).....	29
Timer (Arrêt auto timer).....	32
Horloge hebdomadaire	34
Mode silence unité extérieure.....	37
Réduit de nuit.....	40
Limites.....	43
Économie d'énergie	49
Horloge	54
Heure d'été	56
Écran principal de réglage	58
Explication des icônes	59
Luminosité.....	61
Sélection de la langue	62
Design.....	64
Calibrage de l'écran tactile	66
Nettoyage de l'écran tactile	68
Initialiser la télécommande	70
Informations sur la télécommande.....	72
Résolution des problèmes	74
Information de défaut.....	74
Arrêt automatique en non occupation.....	77
Maintenance	78
Informations sur le filtre.....	78
Caractéristiques	80
Caractéristiques de la télécommande	80
Liste des fonctions (au 1er octobre 2017)	81
Liste des fonctions compatibles / incompatibles entre elles.....	82

Consignes de sécurité

- Lisez attentivement les consignes de sécurité ci-après avant toute utilisation.
- Respectez scrupuleusement ces consignes pour assurer la sécurité.

 AVERTISSEMENT	Signale un risque de blessure grave, voire mortelle.
 ATTENTION	Signale un risque de blessure grave ou de dommage matériel.

- Après avoir lu ce manuel, remettez-le à l'utilisateur final pour qu'il puisse le consulter en cas de besoin.
- Conservez ce manuel pour pouvoir le consulter en cas de besoin. Ce manuel doit être fourni aux personnes chargées de réparer ou de déplacer la télécommande. Assurez-vous que le manuel est bien remis à tout futur utilisateur.

Précautions générales

AVERTISSEMENT

N'installez pas l'unité en un endroit où se trouvent de grandes quantités d'huile, de vapeur, de solvants organiques ou de gaz corrosifs tels du gaz sulfurique ou encore là où sont fréquemment utilisés des aérosols ou des solutions acides/alcalines. Ces substances peuvent affecter les performances de l'unité ou provoquer la corrosion de certains de ses composants, ce qui peut donner lieu à des défauts de fonctionnement, des dégagements de fumée ou même une électrocution ou un incendie.

Ne lavez pas la télécommande avec de l'eau ou tout autre liquide afin de prévenir tout risque de court-circuit, de fuite électrique, d'électrocution, de dysfonctionnement, de fumée ou d'incendie.

N'utilisez pas les commutateurs/touches ou d'autres parties électriques avec les mains mouillées afin de prévenir tout risque d'électrocution, de dysfonctionnement, de fumée ou d'incendie.

Lors de la désinfection de l'appareil à l'aide d'alcool, aérer la pièce de manière adéquate. Les vapeurs d'alcool autour de l'appareil peuvent provoquer un incendie ou d'explosion lorsque l'appareil est allumé.

Pour éviter tout risque de lésion ou d'électrocution, éteignez la télécommande et couvrez-la avant de pulvériser un quelconque produit chimique dans l'environnement de celui-ci.

Pour éviter tout risque de blessure ou d'électrocution, éteignez la télécommande et coupez l'alimentation électrique avant de la nettoyer, de l'examiner, ou avant toute opération d'entretien de celle-ci.

En cas d'anomalie (odeur de brûlé, etc.), arrêtez le système, mettez-le hors tension et contactez immédiatement votre revendeur. L'utilisation continue du produit peut être la cause d'une électrocution, d'un mauvais fonctionnement, ou d'un incendie.

Installez correctement toutes les protections requises pour protéger la télécommande contre l'humidité et la poussière. L'accumulation de poussière et d'eau peut provoquer des électrocutions, de la fumée ou un incendie.

ATTENTION

Pour prévenir tout risque d'incendie ou d'explosion, ne placez pas de matériaux inflammables et ne pulvérisiez pas de substances inflammables dans l'environnement de la télécommande.

Pour prévenir tout risque d'endommager la télécommande, ne pulvérisiez pas d'insecticide ou tout autre aérosol inflammable directement dessus.

Pour réduire le risque de pollution, consultez une agence agréée pour plus d'informations sur la mise au rebut de la télécommande.

Ne touchez pas l'écran tactile, les commutateurs ou les boutons avec un objet pointu ou tranchant afin de prévenir tout risque d'électrocution ou de dysfonctionnement.

Évitez le contact avec les bords tranchants de certaines parties afin de prévenir tout risque de blessure et d'électrocution.

Pour prévenir tout risque de blessure, portez un équipement de protection lors de toute intervention sur la télécommande.

N'exercez pas une force excessive sur les parties en verre pour éviter qu'elles ne se brisent et provoquent des blessures.

Précautions pour le déplacement ou la réparation de la télécommande

AVERTISSEMENT

Seul un personnel qualifié doit être autorisé à réparer la télécommande ou à la changer de place. N'essayez pas de démonter ou de modifier vous-même la télécommande. Une installation ou une réparation non conforme peut entraîner des blessures, une électrocution ou un incendie.

ATTENTION

Pour prévenir tout risque de court-circuit, d'électrocution, d'incendie ou de dysfonctionnement, ne touchez pas le circuit imprimé avec des outils ou vos mains et ne laissez pas la poussière s'accumuler dessus.

Précautions supplémentaires

Pour prévenir tout dommage de la télécommande, utilisez des outils appropriés pour son installation, son inspection ou sa réparation.

Cette télécommande est exclusivement destinée à être utilisée avec le système de gestion d'immeuble Mitsubishi Electric. L'utilisation de cette télécommande avec d'autres systèmes ou à d'autres fins peut entraîner des dysfonctionnements.

Cet appareil n'est pas destiné à être utilisé par des personnes (enfants inclus) dont les capacités mentales, sensorielles ou physiques sont réduite, ou qui ne disposent pas de l'expérience et des connaissances requises, sauf si une personne responsable de leur sécurité assure leur surveillance ou leur formation dans le cadre de l'utilisation de l'appareil. Les enfants doivent être surveillés de manière à ce qu'ils ne puissent pas jouer avec l'appareil.

N'utilisez pas de benzène, de diluant ou d'abrasif chimique pour nettoyer la télécommande, afin d'éviter de la décolorer. Pour nettoyer la télécommande, essuyez-la avec un chiffon doux imbibé d'un mélange d'eau et d'un détergent doux, rincez les restes de détergent avec un chiffon humide, puis essuyez l'eau avec un chiffon sec.

Protégez la télécommande contre l'électricité statique pour éviter de l'endommager.

Cet appareil est prévu pour être utilisé par des utilisateurs experts ou formés dans les magasins, l'industrie légère et les fermes ou pour une utilisation commerciale par des personnes non initiées.

Si le câble électrique est endommagé, il doit être remplacé par le fabricant, son agent de service ou une personne de qualification similaire afin d'éviter tout risque.

Caractéristiques de la télécommande

Interface de la télécommande - Écran d'état/Écran principal de réglage

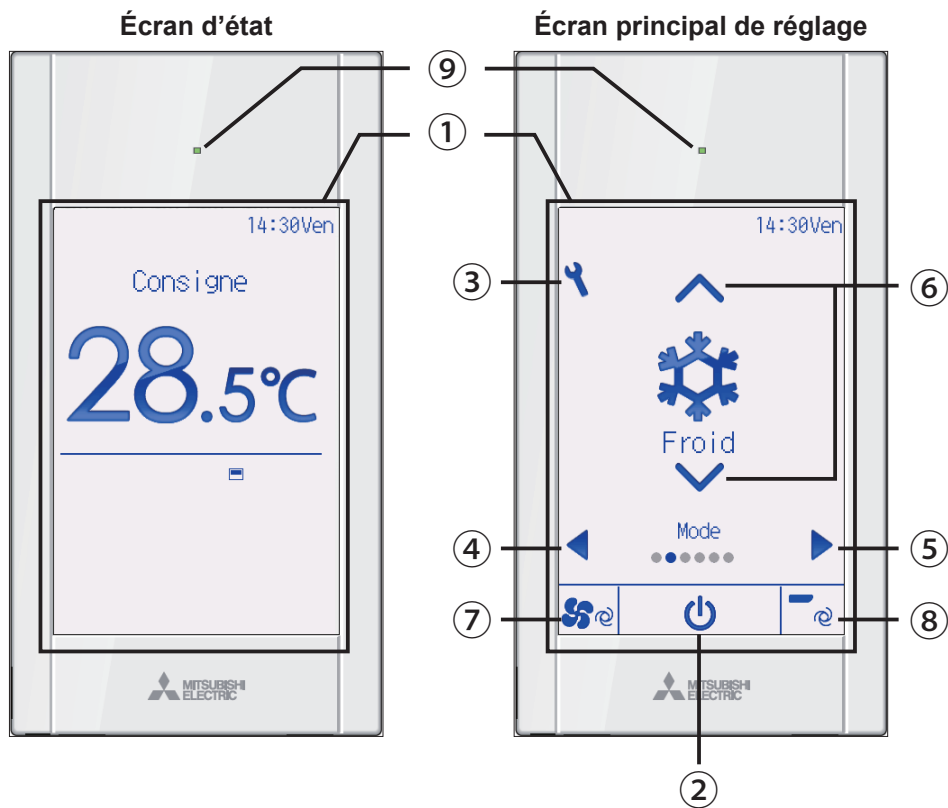

① Écran tactile & Écran LCD couleur rétro-éclairé

Les paramètres de fonctionnement s'affichent.

Lorsque le rétro-éclairage est éteint, appuyer sur une zone quelconque ne fait que faire passer l'écran à l'Écran d'état. Lorsque l'Écran d'état est affiché, appuyer sur une zone quelconque ne fait que faire passer l'écran à l'Écran principal de réglage.

② Bouton **MARCHE/ARRÊT**

Pressez pour allumer ou éteindre l'unité intérieur.

③ Bouton **Réglage**

Pressez pour ouvrir le Menu général. Lorsque le fonctionnement du menu est verrouillé, un mot de passe administrateur est requis.

④ Bouton ◀

Pressez pour commuter les paramètres de réglage selon l'ordre suivant : volet, ventilation, vanne, vitesse ventilateur, mode de fonctionnement et température programmée.

⑤ Bouton ▶

Pressez pour commuter les paramètres de réglage selon l'ordre suivant : température programmée, mode de fonctionnement, vitesse ventilateur, vanne, ventilation e volet.

⑥ Bouton ▲ ▼

Pressez pour changer les valeurs du réglage sélectionné dans ④ et ⑤ ci-dessus.

⑦ Bouton de raccourci vitesse du ventilateur

Pressez pour accéder directement à l'écran de réglage de la vitesse du ventilateur.

⑧ Bouton de raccourci vanne

Pressez pour accéder directement à l'écran de réglage des vannes.

⑨ Voyant Marche / Arrêt

Ce voyant s'allume en vert lorsque le système est en fonctionnement, sauf si « Éclairage LED » est réglé sur « Non ». Il clignote lorsque la télécommande est en cours de démarrage ou en cas d'erreur.

Lorsque la commande Marche/Arrêt est verrouillée, ② n'est pas affiché.

Lorsque le paramètre de réglage est commuté à l'aide du bouton ④ ou ⑤, si le fonctionnement du paramètre de réglage sélectionné est verrouillée, le paramètre ne s'affiche pas.

Si l'opération vitesse ventilateur ou vanne est verrouillée, le paramètre ⑦ ou ⑧ ne s'affiche pas.

Les valeurs du réglage ne peuvent pas être modifiés à l'aide du bouton ⑥ lorsque le paramètre de réglage est contrôlé centralement par la télécommande de système.

Caractéristiques de la télécommande

Interface de la télécommande - Écran du menu

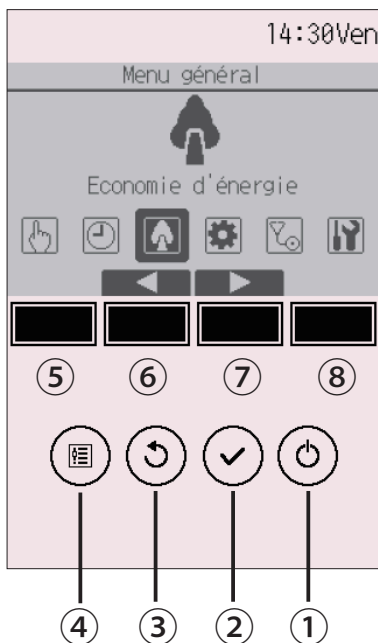

① Bouton **ON/OFF**

Pressez pour allumer ou éteindre l'unité intérieur.

② Bouton **CHOIX**

Pressez pour enregistrer les paramètres.

③ Bouton **RETOUR**

Pressez pour revenir à l'écran précédent. Lorsque le Menu général est affiché, appuyer sur ce bouton active l'Écran d'état.

④ Bouton **MENU**

Page 24

Pressez pour ouvrir le Menu général.

⑤ Boutons de fonctions **F1**

Écran des menus : La fonction du bouton varie selon l'écran.

⑥ Boutons de fonctions **F2**

Menu général : Pressez pour déplacer le curseur vers la gauche.

Écran des menus : La fonction du bouton varie selon l'écran.

⑦ Boutons de fonctions **F3**

Menu général : Pressez pour déplacer le curseur vers la droite.

Écran des menus : La fonction du bouton varie selon l'écran.

⑧ Boutons de fonctions **F4**

Écran des menus : La fonction du bouton varie selon l'écran.

Les fonctions réalisées par les boutons varient en fonction de l'écran. Consultez le guide de fonction des boutons en bas de l'écran LCD pour voir les fonctions correspondant à un écran donné.

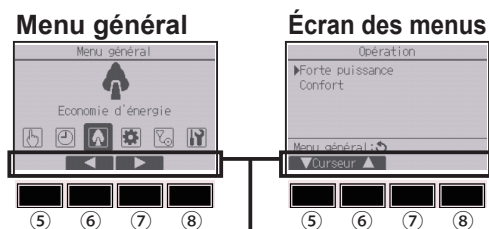

Guide des fonctions

Caractéristiques de la télécommande

Écran - Écran d'état/Écran principal de réglage

L'Écran d'état et l'Écran principal de réglage peuvent être affichés dans deux modes différents : « Complet » et « Basic ».
Le réglage usine est « Complet ». Pour savoir comment commuter les modes, reportez-vous à page 58.

Mode Complet

* Toutes les icônes sont affichées pour la compréhension.

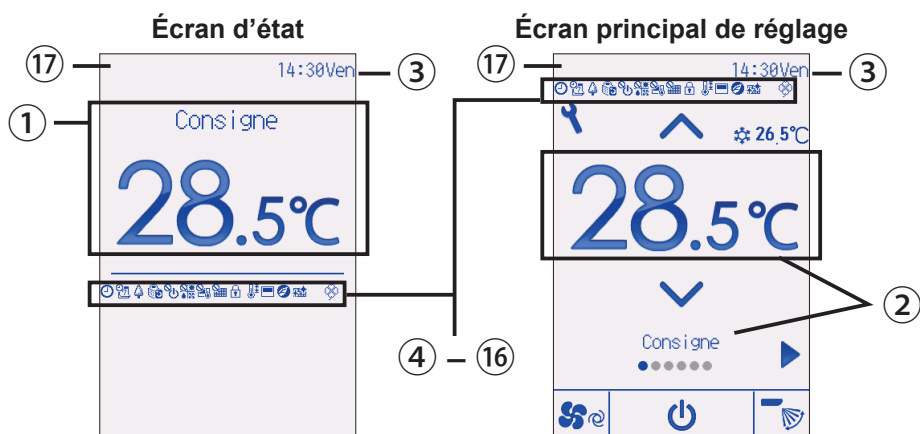

Mode Basique

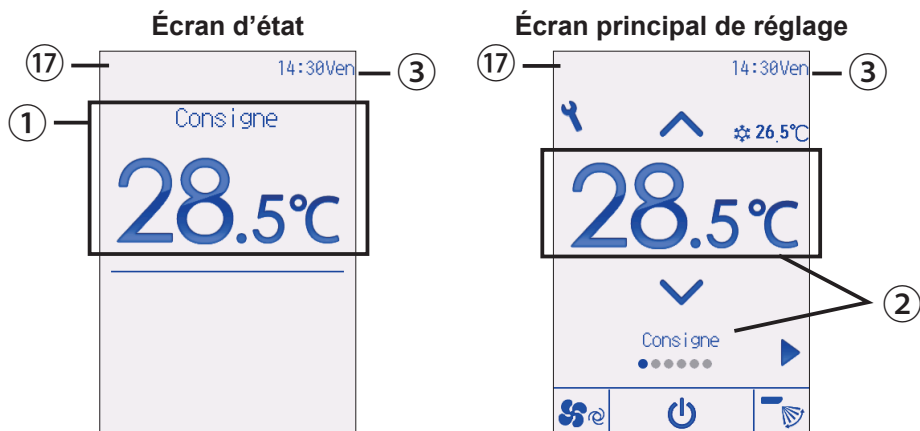

① Température programmée ou température de la pièce

La température programmée ou la température de la pièce s'affichent ici. (Voir le manuel d'installation.)

② Éléments de réglage et valeur des réglages Page 17

Les paramètres de réglage « Température programmée » ↔ « Mode de fonctionnement » ↔ « Vitesse ventilateur » ↔ « Vanne » ↔ « Ventilation » ↔ « Volet » et les valeurs de leur réglage s'affichent ici. « Contrôle centralisé » s'affiche pendant un certain temps lorsqu'un élément contrôlé de manière centralisée est utilisé.

③ Horloge

L'heure actuelle s'affiche ici. (Voir le manuel d'installation.)

④ Page 29, 32, 40

Apparaît lorsque la fonction ON/OFF timer (page 29), Réduit de nuit (page 40) ou Arrêt auto timer (page 32) est activée.

 apparaît lorsque le timer est désactivé par le système de contrôle centralisé.

⑤ Page 34

S'affiche si le programmeur hebdomadaire est activé.

⑥ Page 51

S'affiche lorsque le système est en mode économie d'énergie. (Ceci n'apparaîtra pas sur certains modèles d'unités d'intérieur)

⑦ Page 37

S'affiche lorsque les unités extérieures sont en mode silencieux.

⑧

S'affiche lorsque la fonction ON et la fonction OFF sont contrôlés centralement.

⑨

S'affiche lorsque le mode de fonctionnement est contrôlé centralement.

⑩

S'affiche lorsque la température programmée est contrôlée centralement.

⑪

S'affiche si la remise à zéro du filtre est contrôlée centralement.

⑫ Page 46

S'affiche lorsque les boutons sont verrouillés.

⑬ Page 43

S'affiche lorsque la plage de température programmée est limitée.

⑭

S'affiche lorsque la thermistance intégrée à la télécommande est utilisée pour mesurer la température de la pièce.

 s'affiche lorsque la thermistance de l'unité intérieure est utilisée pour mesurer la température de la pièce.

⑮

S'affiche lorsque le fonctionnement en économie d'énergie est réalisé à l'aide d'une fonction « 3D i-See sensor ».

⑯ Page 78

Indique si le filtre a besoin d'entretien.

⑰ Affichage des erreurs préliminaires

Un code défaut s'affiche en présence d'une erreur préliminaire.

Structure et icônes des menus

Structure des menus

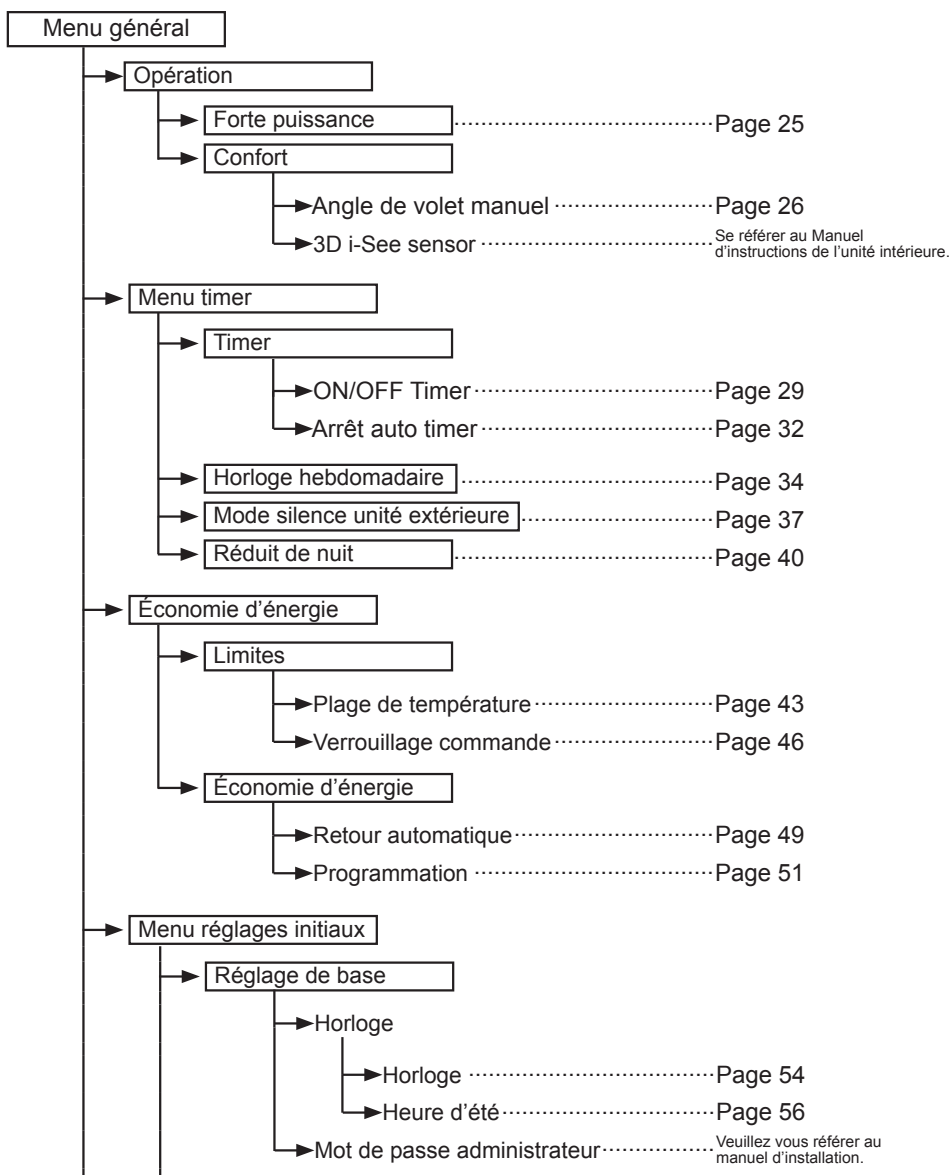

→	→	Réglage de l'écran		
	→	→	Écran principal de réglage Page 58	
	→	→	Affichage détails (Icône explications, etc.)... Veuillez vous référer au manuel d'installation.	
	→	→	Luminosité Page 61	
	→	→	Sélection de la langue Page 62	
	→	→	Design Page 64	
	→	Réglage d'opération		
	→	→	Mode automatique Veuillez vous référer au manuel d'installation.	
	→	Écran tactile Page 66	
→		Menu maintenance		
	→	→	Informations de défaut Page 74	
	→	→	Informations sur le filtre Page 78	
	→	→	Nettoyage	
	→	→	→	Descente automatique façade Veuillez vous référer au manuel d'instructions fourni avec le système automatique de montée.
			→	Opération de descente Veuillez vous référer au manuel d'instructions fourni avec le système automatique de montée.
			→	Réglage de descente Veuillez vous référer au manuel d'instructions fourni avec le système automatique de montée.
→		Menu SAV		
	→	→	Menu Test fonctions	
		→	→	Test fonctions Veuillez vous référer au manuel d'installation de l'unité intérieure.
		→	→	Test pompe des condensats Veuillez vous référer au manuel d'installation de l'unité intérieure.
	→	→	Informations de maintenance Veuillez vous référer au manuel d'installation de l'unité intérieure.	
		→	→	Entrer le modèle d'unités Veuillez vous référer au manuel d'installation de l'unité intérieure.
		→	→	Entrer le N° de série Veuillez vous référer au manuel d'installation de l'unité intérieure.
		→	→	Entrer informations vendeur Veuillez vous référer au manuel d'installation de l'unité intérieure.
		→	→	Reset informations maintenance Veuillez vous référer au manuel d'installation de l'unité intérieure.

Structure et icônes des menus

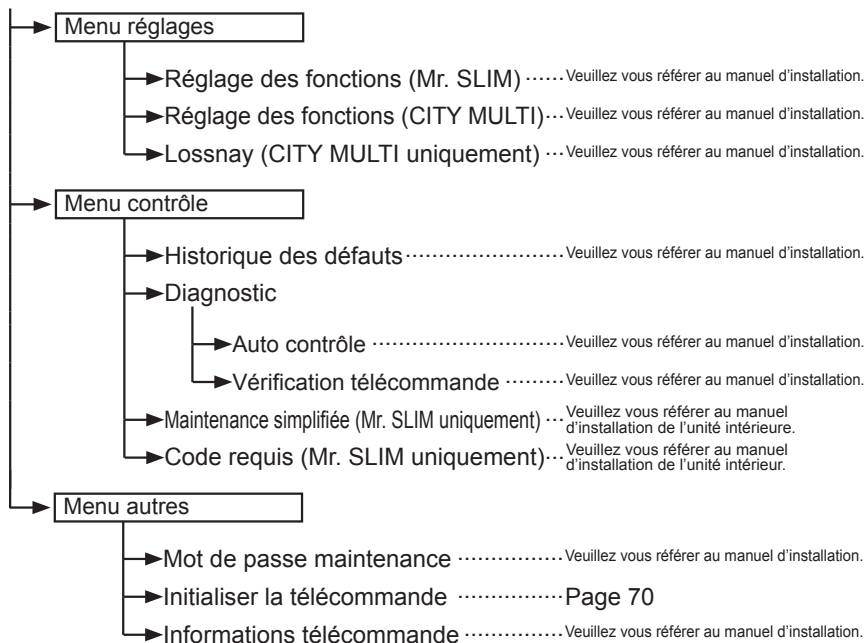

Toutes les fonctions ne sont pas disponibles sur tous les modèles d'unités intérieures.

Fonctionnement télécommande

Timer



Le tableau ci-dessous résume les icônes carrées utilisées dans ce manuel.



Le mot de passe d'utilisateur administrateur ou maintenance doit être entré sur l'écran de saisie de mot de passe pour modifier les paramètres. Aucun réglage ne permet de sauter cette étape.

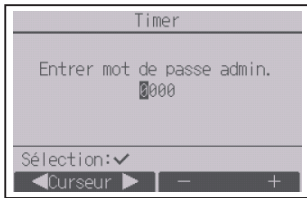

F1 F2 F3 F4

- F1** : Pressez pour déplacer le curseur vers la gauche.
- F2** : Pressez pour déplacer le curseur vers la droite.
- F3** : Pressez pour diminuer la valeur de 1.
- F4** : Pressez pour augmenter la valeur de 1.

* Les changements ne peuvent être effectués que si le mot de passe correct est entré.



Indique un réglage qui ne peut être modifié que lorsque les appareils sont en fonctionnement.



Indique un réglage qui ne peut être modifié que lorsque les appareils ne sont pas en fonctionnement.



Indique un réglage qui ne peut être modifié que lorsque les appareils sont en mode refroidissement, chauffage ou automatique.



Indique une fonction qui n'est pas disponible lorsque les boutons sont verrouillés, ou lorsque le système est contrôlé centralement.

Opérations de base

Marche / Arrêt



Fonctionnement des boutons

Marche

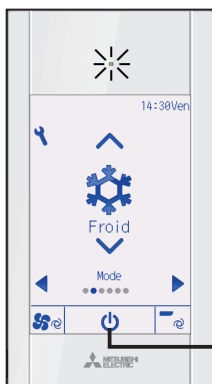

Pressez le bouton **MARCHE/ARRÊT**.

Le voyant Marche / Arrêt s'allume en vert, et l'appareil démarre.

Lorsque « Éclairage LED » est réglé sur « Non », le voyant Marche / Arrêt ne s'allume pas.

Bouton **MARCHE/ARRÊT**

Arrêt



Pressez de nouveau le bouton **MARCHE/ARRÊT**.

Le voyant Marche / Arrêt s'éteint, et l'appareil s'arrête.



Fonctionnement des boutons

Mode de fonctionnement

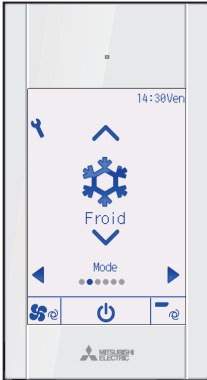

Chaque pression sur le bouton ▼ ou ▲ fait défiler les modes de fonctionnement suivants.

Sélectionnez le mode de fonctionnement désiré.



Froid



Dés humidifié



Ventilateur



Auto



Chaud

- Les modes de fonctionnement qui ne sont pas disponibles pour les modèles d'unités intérieures connectés n'apparaîtront pas sur l'écran.

Que signifie le fait que l'icône du mode clignote

L'icône de mode clignote lorsque d'autres unités intérieures du même système réfrigérant (connectés au même unité extérieur) sont déjà dans un mode différent. Dans ce cas, les autres unités du même groupe ne peuvent fonctionner que dans le même mode.

<Mode Automatique (point de réglage double)>

Lorsque le mode de fonctionnement est réglé sur le mode Automatique (point de réglage double), deux températures programmées (une pour rafraîchir et une pour chauffer) peuvent être réglées. Selon la température de la pièce, l'unité intérieure fonctionne automatiquement en mode Froid ou Chaud et maintient la température de la pièce dans la plage programmée.

Le graphique ci-dessous montre le schéma de fonctionnement d'une unité intérieure en mode Automatique (point de réglage double).

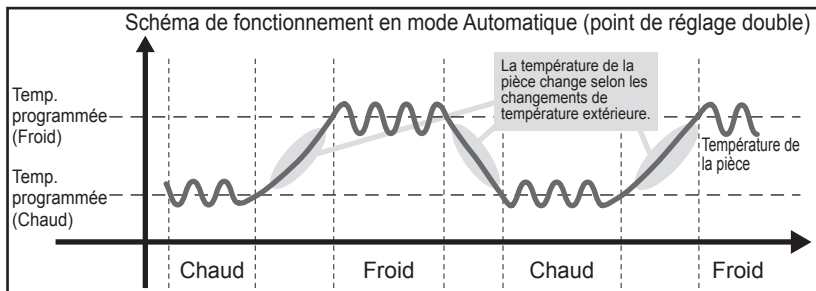



Opérations de base

Température programmée

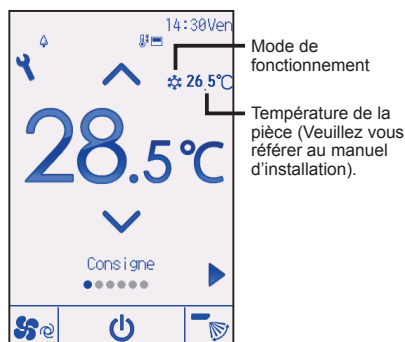
<Froid, Déshumidification, Chaud, et Automatique (point de réglage simple)>





Pressez le bouton  pour diminuer la température programmée, et le bouton  pour l'augmenter.

- Consultez le tableau de la page 19 pour la plage de température réglable en fonction du mode de fonctionnement.
- La plage de température ne peut pas être programmée en mode ventilateur/ventilation.
- Les températures programmées sont affichées soit en Centigrade avec incréments de 0,5- ou 1- degrés, soit en Fahrenheit, selon le modèle d'unité intérieure et le réglage du mode d'affichage sur la télécommande.

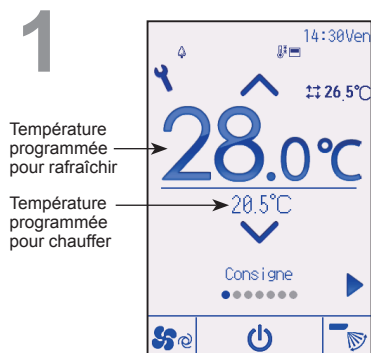
<Mode Automatique (point de réglage double)>



Les températures programmées actuelles s'affichent.

Chaque pression sur le bouton  ou  commute les températures programmées entre refroidissement et chauffage.

2

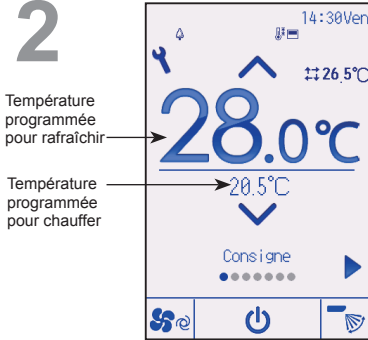

Pressez le bouton ▼ pour diminuer la température programmée, et le bouton ▲ pour l'augmenter.

- Consultez le tableau ci-dessous pour la plage de température réglable en fonction du mode de fonctionnement.
- Les réglages de température programmée pour rafraîchir et chauffer avec le mode Automatique (point de réglage double) sont aussi utilisés par les modes Froid / Déshumidification et Chaud.
- Les températures programmées pour rafraîchir et chauffer en mode Automatique (point de réglage double) doivent satisfaire aux conditions ci-dessous :
 - La température programmée pour rafraîchir est plus élevée que la température programmée pour chauffer.
 - La différence de température minimale requise entre les températures programmées pour chauffer et rafraîchir (ceci varie selon les modèles d'unités intérieures connectées) est atteinte.
 - Si les températures programmées sont réglées de telle manière qu'elles n'atteignent pas la différence de température minimale requise, ces températures programmées seront toutes deux automatiquement changées selon les plages de réglages possibles.

Plage de réglage de la température

Mode de fonctionnement	Plage de réglage de la température
Froid / Déshumidification	19 à 30°C (67 à 87°F)
Chaud	17 à 28°C (63 à 83°F)
Automatique (Point de réglage simple)	19 à 28°C (67 à 83°F)
Automatique (Points de réglage doubles)	[Froid] Plage de température programmée pour le mode Froid [Chaud] Plage de température programmée pour le mode Chaud
Ventilateur/Ventilation	Non réglable

La plage de réglage de la température varie en fonction du modèle de l'unité intérieure.

Opérations de base

Vitesse du ventilateur

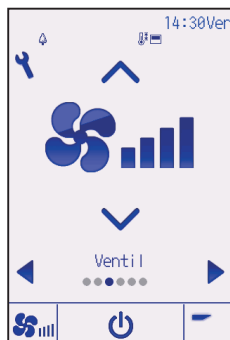

Chaque pression sur le bouton ▼ ou ▲ fait défiler les vitesses ventilateur suivantes.

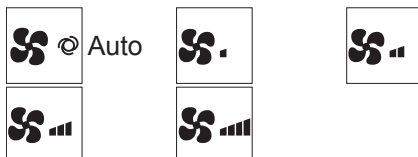

- Les vitesses de ventilation disponibles dépendent du modèle d'unité intérieure connectée.

Réglage de vanne



(Exemple d'écran sur CITY MULTI)

Chaque pression sur le bouton ▼ ou ▲ fait défiler les vitesses des vannes suivantes. Sélectionnez le réglage désiré.

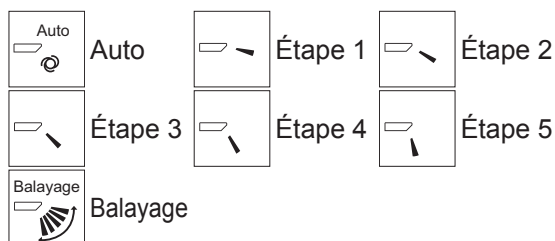

Sélectionnez « Balayage » pour faire basculer automatiquement vers le haut/le bas les vannes.

Lorsqu'il est réglé sur « Étape 1 » à « Étape 5 », les vannes se positionnent à l'angle sélectionné.

- **1h** à gauche de l'icône de réglage des vannes. Cette icône apparaît lorsque les vannes sont réglées sur Étape 2, 3, 4 ou 5 et que le ventilateur fonctionne à basse vitesse pendant le refroidissement ou la déshumidification (selon le modèle). L'icône disparaît au bout d'une heure, et les vannes se repositionnent automatiquement.

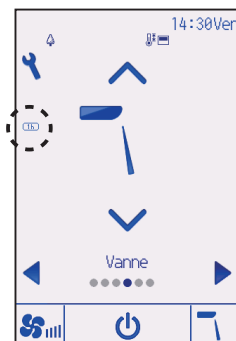

Réglage du volet

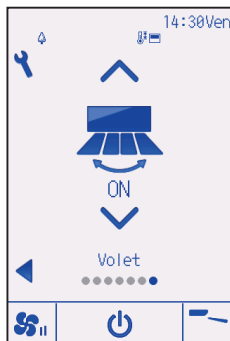

(Exemple d'écran sur CITY MULTI)

Pressez le bouton ▼ ou ▲ pour activer ou désactiver le balayage du volet.



Réglage de la ventilation

Le réglage de la ventilation peut se faire même lorsque les unités fonctionnent.

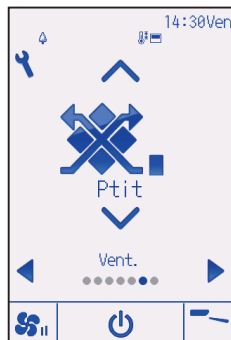

(Exemple d'écran sur Mr. SLIM)

Chaque pression sur le bouton ▼ ou ▲ fait défiler les réglages de ventilation suivants.

* Réglable seulement lorsque l'unité Lossnay est connectée.



• Le ventilateur de certains modèles d'unités intérieures peut être synchronisé avec certains modèles d'unités de ventilation.

Naviguer dans le menu

Liste du Menu général

Menu général	Éléments des réglages		Détail des réglages	Page
Opération	Forte puissance		Sert à atteindre rapidement une température confortable dans la pièce. <ul style="list-style-type: none"> Les unités peuvent fonctionner en mode forte puissance pendant 30 minutes au maximum. 	25
	Confort	Angle de volet manuel	Sert à régler l'angle des vannes.	26
Timer	Timer	ON/OFF timer	Sert à régler les heures de mise en marche et d'arrêt. <ul style="list-style-type: none"> La durée peut être réglée par incréments de 5 minutes. * L'heure doit avoir été réglée. 	29
		Arrêt auto timer	Sert à régler l'heure d'arrêt automatique. <ul style="list-style-type: none"> La durée peut être réglée sur une valeur de 30 à 240 par incréments de 10 minutes. 	32
	Horloge hebdomadaire		Sert à régler les heures de mise en marche et d'arrêt pour le fonctionnement hebdomadaire. <ul style="list-style-type: none"> Jusqu'à huit schémas de fonctionnement peuvent être définis pour chaque jour. Deux types de programmes hebdomadaires peuvent être réglés. * L'heure doit avoir été réglée. * Ne fonctionne pas lorsque le ON/OFF timer est activé. * Incréments de 1°C 	34
	Mode silence unité extérieure		Sert à définir les périodes pour lesquelles la priorité est donnée à un fonctionnement silencieux des unités extérieures plutôt qu'à la régulation de la température. Régler les heures de démarrage et d'arrêt pour chaque jour de la semaine. <ul style="list-style-type: none"> Sélectionnez le niveau de silence souhaité parmi « Normal » « Moyen » et « Silencieux » * L'heure doit avoir été réglée. 	37
	Réduit de nuit		Sert à régler les paramètres du Réduit de nuit. <ul style="list-style-type: none"> Sélectionnez « Oui » pour activer le réglage et « Non » pour le désactiver. La plage de température et les heures de mise en marche et d'arrêt peuvent être réglées. * L'heure doit avoir été réglée. * Incréments de 1°C 	40
Économie d'énergie	Limites	Plage de température	Sert à limiter la plage de température autorisée. <ul style="list-style-type: none"> Des plages de température différentes peuvent être définies pour différents modes de fonctionnement. * Incréments de 1°C 	43
		Commande bloquée	Sert à verrouiller les fonctions sélectionnées. <ul style="list-style-type: none"> Les fonctions verrouillées ne peuvent pas être utilisées. 	46
	Économie d'énergie	Retour automatique	Sert à faire revenir les unités à la température programmée après une durée choisie de fonctionnement en économie d'énergie. <ul style="list-style-type: none"> La durée peut être réglée sur une valeur de 30 à 120 par incréments de 10 minutes. * Cette fonction n'est pas autorisée lorsque la plage de température programmée est limitée. * Incréments de 1°C 	49

Menu général	Éléments des réglages		Détail des réglages	Page
Économie d'énergie	Économie d'énergie	Programmation	<p>Règle les heures pendant lesquelles les unités fonctionneront en mode économie d'énergie pour chaque jour de la semaine, et règle le taux d'économie.</p> <ul style="list-style-type: none"> • Jusqu'à quatre schéma de fonctionnement en économie d'énergie peuvent être définis pour chaque jour. • La durée peut être réglée par incréments de 5 minutes. • Le taux d'économie d'énergie peut être réglé à une valeur de 0% et de 50 à 90% par incréments de 10%. <p>* L'heure doit avoir été réglée.</p>	51
		Réglage de base	<p>Horloge</p> <p>Sert à régler l'heure.</p>	54
Réglages initiaux	Réglage de base	Heure d'été	Sert à régler l'heure d'été.	56
		Réglage de l'écran	Écran principal de réglage	<p>Sert à basculer l'Écran d'état et l'Écran principal de réglage entre les modes « Complet » et « Basic ».</p> <ul style="list-style-type: none"> • Le réglage par défaut est « Complet ».
	Luminosité		Sert à régler la luminosité de l'écran.	61
	Sélection de la langue		Sert à choisir la langue.	62
	Design		Sert à changer les couleurs de l'Écran d'état et de l'Écran principal de réglage.	64
	Écran tactile	Calibrage de l'écran tactile	Sert à régler les paramètres de calibrage de l'écran tactile.	66
		Nettoyage de l'écran tactile	Rend l'écran tactile temporairement insensible au toucher pour permettre de le nettoyer.	68
	Service	Initialiser la télécommande		Sert à initialiser la télécommande à l'état d'expédition de l'usine.
Informations sur la télécommande		Sert à afficher le nom du modèle de la télécommande, la version du logiciel et le numéro de série.	72	
Maintenance	Informations de défaut		<p>Sert à vérifier les informations de défaut lorsqu'un défaut se produit.</p> <ul style="list-style-type: none"> • Le code de défaut, la source du défaut, l'adresse du réfrigérant, le modèle de l'unité, le numéro de fabrication, les coordonnées de contact (numéro de téléphone du revendeur) peuvent être affichés. * Le modèle de l'unité, le numéro de fabrication, et les coordonnées de contact doivent être entrés à l'avance pour être affichés. 	74
	Informations sur le filtre		<p>Sert à vérifier l'état du filtre.</p> <ul style="list-style-type: none"> • Le témoin d'état du filtre peut être remis à zéro. 	78

Naviguer dans le menu

Naviguer dans le Menu général

Fonctionnement des boutons

Accéder au Menu général



Pressez le bouton **Réglage** sur l'Écran principal de réglage.

Le Menu général apparaît.

Sélection du paramètre

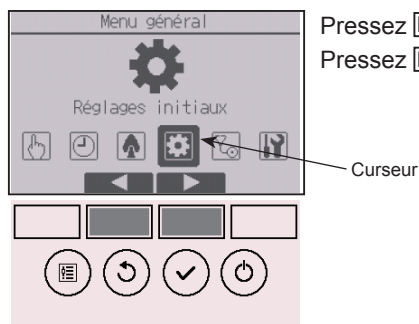

Pressez **F2** pour déplacer le curseur vers la gauche.

Pressez **F3** pour déplacer le curseur vers la droite.

Réglages des fonctions

Forte puissance



Descriptions des fonctions

Le fonctionnement à forte puissance permet aux unités de fonctionner à capacité plus élevée que la normale de façon à atteindre la température désirée plus rapidement. Ce mode de fonctionnement a une durée de 30 minutes au maximum. L'unité revient en mode de fonctionnement normal à la fin des 30 minutes, ou lorsque la température de la pièce atteint la température programmée. Les unités reviennent en mode de fonctionnement normal lorsque le mode de fonctionnement ou la vitesse du ventilateur est modifié.

Fonctionnement des boutons

1



Sélectionnez « Forte puissance » dans le Menu de opération en mode refroidissement, chauffage ou automatique et pressez le bouton **[CHOIX]**.

Le mode « Forte puissance » n'est disponible que sur les modèles qui prennent en charge la fonction.

2



Placez le curseur sur « Oui » avec les boutons **[F3]** ou **[F4]** et pressez le bouton **[CHOIX]**.

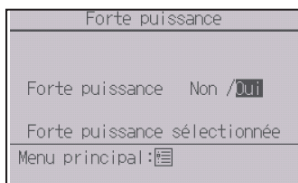

Un écran de confirmation s'affiche.

Naviguer dans les écrans

- Pour revenir au Menu général bouton **[MENU]**
- Pour revenir à l'écran précédent bouton **[RETOUR]**

Réglages des fonctions

Angle de volet manuel

OFF

Fonctionnement des boutons

1



Sélectionnez « Confort » dans le Menu de opération et pressez le bouton **[CHOIX]**.

2



Sélectionnez « Angle de volet manuel » avec le bouton **[F1]** ou **[F2]** et pressez le bouton **[CHOIX]**.

3

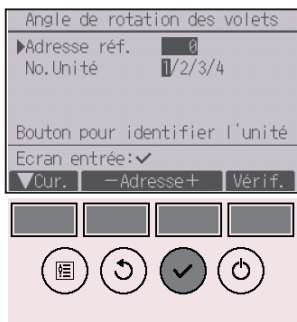

Déplacez le curseur sur « Adresse réf. » ou sur « N° Unité » avec le bouton [F1].

Sélectionnez avec le bouton [F2] ou [F3] l'adresse du réfrigérant et le numéro d'unité pour les unités dont les vannes doivent être installées, puis pressez le bouton [CHOIX].

- Adresse réf. : Adresse du réfrigérant

- N° Unité : 1, 2, 3, 4

Pressez le bouton [F4] pour confirmer l'unité.

L'écran affiche sur la gauche un exemple de Mr. SLIM. Sur les unités CITY MULTI, le paramètre « Adresse M-NET » s'affiché au lieu de « Adresse réf. » et le paramètre « N° Unité » n'est pas affiché.

4

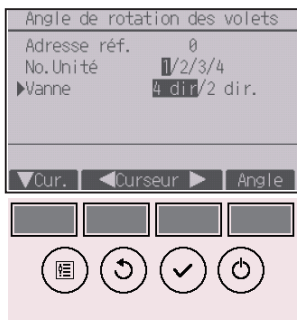

Sélectionnez « Vanne » avec le bouton [F1].

Sélectionnez « 4 dir. » ou « 2 dir. » avec le bouton [F2] ou [F3] et pressez le bouton [F4].

Réglages des fonctions

5

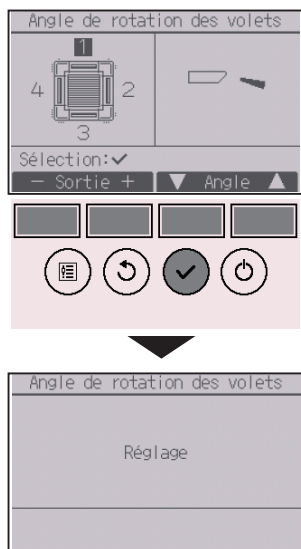

Le réglage actuel des vannes s'affiche.

Sélectionnez les sorties d'air désirées, parmi « 1 », « 2 », « 3 », « 4 » ou « 1, 2, 3, 4 (toutes les sortie) », à l'aide du bouton [F1] ou [F2].

Pressez le bouton [F3] ou [F4] pour faire défiler les options ci-dessous et sélectionner le réglage souhaité.

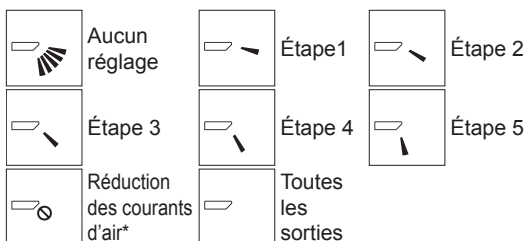

Pressez le bouton [CHOIX] pour enregistrer les réglages.

Un écran s'affiche pour vous informer que les réglages sont en cours d'envoi.

Les changements seront effectués sur la sortie sélectionnée.

L'écran retournera automatiquement à l'écran précédent lorsque la transmission est terminée.

Effectuez les réglages pour les autres sorties, selon la même procédure.

Si toutes les sorties sont sélectionnées,  sera affiché à la prochaine mise en route de l'appareil.

Naviguer dans les écrans

• Pour revenir à l'écran précédent bouton [RETOUR]

*Réduction des courants d'air

Le mode [Réduction des courants d'air] garde l'angle des vannes plus horizontal que l'angle du Étape 1 de sorte que le flux d'air ne soit pas dirigé vers les personnes.

Cette fonction ne peut être réglée que pour une sortie.

Cette fonction ne peut être réglée pour les modèles avec deux ou trois sorties.

Dans le mode Réduction des courants d'air, le flux d'air peut entraîner la décoloration du plafond.

Timer (ON/OFF timer)



Fonctionnement des boutons

1

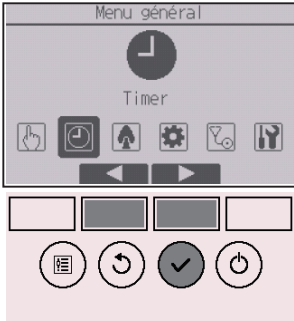

Sélectionnez « Timer » dans le Menu général (voir page 24), et pressez le bouton **CHOIX**.

Le ON/OFF timer ne fonctionne pas dans les cas suivants :

lorsque le ON/OFF timer est désactivé, en présence d'un défaut, lors de tests (dans le Menu SAV), lors du test des fonctions, lors du diagnostic de la télécommande, lorsque l'horloge n'est pas réglée, lors du réglage des fonctions, lorsque le système est contrôlé centralement (lorsque la fonction Marche/ Arrêt ou la fonction timer à partir de la télécommande locale sont interdites).

2

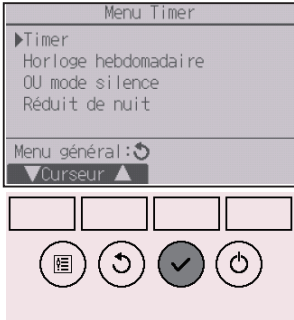

Placez le curseur sur « Timer » et pressez le bouton **CHOIX**.

3



Les réglages actuels s'affichent.

Placez le curseur sur « ON/OFF timer » et pressez le bouton **CHOIX**.

Réglages des fonctions

4



L'écran permettant de régler le timer s'affiche.

Sélectionnez le paramètre souhaité avec le bouton **F1** ou **F2** (« ON/OFF timer », « Marche », « Arrêt » ou « Répéter »).

5



Modifiez le réglage avec le bouton **F3** ou **F4**.

- ON/OFF timer : Non (désactivé) / Oui (activé)
- Marche : Heure début fonctionnement (réglable par incréments de 5 minutes)
 - * Pressez et maintenez le bouton enfoncé pour faire défiler rapidement les chiffres.
- Arrêt : Heure arrêt fonctionnement (réglable par incréments de 5 minutes)
 - * Pressez et maintenez le bouton enfoncé pour faire défiler rapidement les chiffres.
- Répéter : Non (une fois) / Oui (en boucle)

6



Pressez le bouton [CHOIX] pour enregistrer les réglages.





Un écran de confirmation s'affiche.

Naviguer dans les écrans

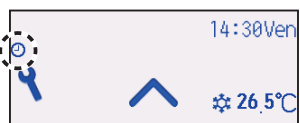
- Pour revenir au Menu général bouton [MENU]
- Pour revenir à l'écran précédent bouton [RETOUR]



 apparaît sur l'Écran d'état et l'Écran principal de réglage en mode Complet lorsque l'ON/OFF timer est activé.

 apparaît lorsque le timer est désactivé par le système de contrôle centralisé.

Réglages des fonctions

Timer (Arrêt auto timer)



Fonctionnement des boutons

1



Affichez l'écran de réglage du Timer.
(Veuillez vous référer à la page 29.)

Sélectionnez « Arrêt Auto » et pressez le bouton

CHOIX.

Le Arrêt auto timer ne fonctionne pas dans les cas suivants :

lorsque le Arrêt auto timer est désactivé, en présence d'un défaut, lors de tests (dans le Menu SAV), lors du test des fonctions, lors du diagnostic de la télécommande, lors du réglage des fonctions, lorsque le système est contrôlé centralement (lorsque la fonction ON/OFF ou la fonction timer à partir de la télécommande locale sont interdites).

2



Les réglages actuels s'affichent.

Placez le curseur sur « Arrêt Auto » ou « Arrêt dans --- min » avec le bouton **F1** ou **F2**.

3



Modifiez le réglage avec le bouton **F3** ou **F4**.

- Arrêt Auto : Non (désactivé) / Oui (activé)
- Arrêt dans --- min : réglage du timer (réglable de 30 à 240 minutes par incréments de 10 minutes).

4



Pressez le bouton **CHOIX** pour enregistrer les réglages.





Un écran de confirmation s'affiche.

Naviguer dans les écrans

- Pour revenir au Menu général bouton **MENU**
- Pour revenir à l'écran précédent bouton **RETOUR**



 apparaît sur l'Écran d'état et l'Écran principal de réglage en mode Complet lorsque l'Arrêt auto timer est activé.

 apparaît lorsque le timer est désactivé par le système de contrôle centralisé.

Réglages des fonctions

Horloge hebdomadaire



Fonctionnement des boutons

1



Sélectionnez « Horloge hebdomadaire » dans le Menu timer et pressez le bouton **CHOIX**.

L'Horloge hebdomadaire ne fonctionne pas dans les cas suivants :

lorsque le ON/OFF timer est activé, lorsque l'horloge hebdomadaire est désactivé, en présence d'un défaut, lors de tests (dans le Menu SAV), lors du test des fonctions, lors du diagnostic de la télécommande, lorsque l'horloge n'est pas réglée, lors du réglage des fonctions, lorsque le système est contrôlé centralement (Lorsque la fonction ON/OFF, la fonction de réglage de la température ou la fonction timer à partir de la télécommande locale sont interdites).

2



Les réglages actuels s'affichent.

Pressez le bouton **F1** ou **F2** pour afficher les réglages pour chaque jour de la semaine.

Pressez le bouton **F3** pour voir les schémas de 5 à 8.

Pressez le bouton **F4** pour afficher l'état du Réglage 2.

Pressez le bouton **CHOIX** pour passer à l'écran des réglages.

3



L'écran de réglages de l'horloge hebdomadaire s'affiche.

Dans le réglage « Action », sélectionnez « 1 » pour activer le réglage de timer 1 ou sélectionnez « 2 » pour activer le réglage de timer 2 en utilisant les bouton **[F3]** ou **[F4]**. Pressez le bouton **[CHOIX]**.

Pour vérifier la valeur des réglages 1 ou 2 du timer, déplacez le curseur sur « Réglage » à l'aide du bouton **[F1]** ou **[F2]** et sélectionnez « 1 » ou « 2 » avec le bouton **[F3]** ou **[F4]**.

4



L'écran de réglage de l'horloge hebdomadaire s'affiche, avec les réglages actuels.

Jusqu'à huit schémas de fonctionnement peuvent être définis pour chaque jour.

Placez le curseur sur le jour de la semaine souhaité à l'aide du bouton **[F1]** ou **[F2]**, puis pressez le bouton **[F3]** pour le sélectionner. (Plusieurs jours peuvent être sélectionnés.)

Pressez le bouton **[CHOIX]**.

Réglages des fonctions

5

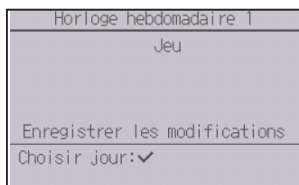
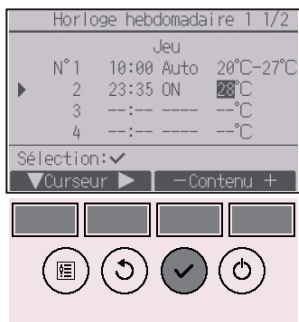

L'écran de réglage des schémas de fonctionnement s'affiche.

Pressez le bouton **[F1]** pour déplacer le curseur sur le numéro de schéma désiré.

Placez le curseur sur l'heure, sur ON/OFF ou sur température, au moyen du bouton **[F2]**.

Modifiez le réglage avec le bouton **[F3]** ou **[F4]**.

- Heure : réglable par incréments de 5 minutes
 - * Pressez et maintenez le bouton enfoncé pour faire défiler rapidement les chiffres.
- ON/OFF/Auto : Les réglages disponibles dépendent du modèle de l'unité intérieure connectée. (Lorsqu'un schéma automatique est exécuté, le système fonctionne en mode automatique (point de réglage double).)
- Température : La plage de réglage de température varie en fonction de l'unité intérieure connectée. (Incréments de 1°C) Lorsque le mode Automatique (point de réglage double) est sélectionné, il est possible de programmer deux températures. Si un schéma de fonctionnement avec un réglage de température simple est exécuté lors du mode « Automatique » (point de réglage double), son réglage est utilisé comme réglage de température pour rafraîchir en mode « Froid ».

Pressez le bouton **[CHOIX]** pour enregistrer les réglages.

Un écran de confirmation s'affiche.

Naviguer dans les écrans

- Pour revenir à l'écran de sélection du réglage changement/ jour de la semaine bouton **[CHOIX]**
- Pour revenir au Menu général bouton **[MENU]**
- Pour revenir à l'écran précédent bouton **[RETOUR]**



[7] apparaît sur l'Écran d'état et sur l'Écran principal de réglage en mode Complet quand un réglage d'horloge hebdomadaire existe pour le jour actuel. L'icône n'apparaît pas lorsque le ON/OFF timer est activé ou lorsque le système est sous contrôle centralisé (la fonction Timer à partir de la télécommande locale est interdite).

Descriptions des fonctions

Cette fonction permet à l'utilisateur de définir les périodes pendant lesquelles la priorité est donnée à un fonctionnement silencieux des unités extérieures plutôt qu'à la régulation de la température. Réglez les heures de démarrage et d'arrêt du mode silence pour chaque jour de la semaine. Sélectionnez le niveau de silence souhaité entre « Moyen » et « Silencieux ».

Fonctionnement des boutons

1

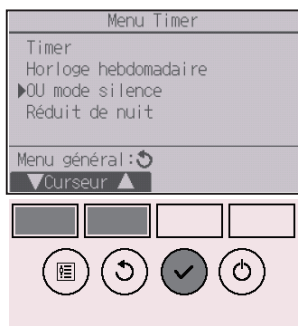

Sélectionnez « OU mode silence » dans le Menu timer et pressez le bouton **[CHOIX]**.

La fonction « OU mode silence » n'est disponible que sur les modèles qui prennent en charge la fonction.

2



Les réglages actuels s'affichent.

Pressez le bouton **[F1]** ou **[F2]** pour afficher les réglages pour chaque jour de la semaine.

Pressez le bouton **[CHOIX]** pour passer à l'écran des réglages.

Réglages des fonctions

3



L'écran permettant d'autoriser (Oui) ou d'interdire (Non) le mode silence s'affiche.

Pour activer ce réglage, placez le curseur sur « Oui » avec le bouton [F3] ou [F4] et pressez le bouton [CHOIX].

4



L'écran de réglage d'Mode silence unité extérieure s'affiche.

Pour créer ou modifier le réglage, placez le curseur sur le jour de la semaine désiré avec le bouton [F1] ou [F2] puis pressez le bouton [F3] pour le sélectionner. (Plusieurs jours peuvent être sélectionnés.)

Pressez le bouton [CHOIX].

5

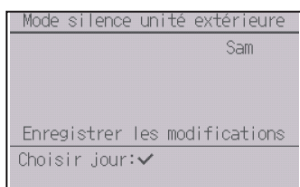

L'écran de réglage s'affiche.

Placez le curseur sur le paramètre souhaité avec le bouton **F1** ou **F2** (heure de démarrage, heure d'arrêt ou niveau de silence).

Modifiez le réglage avec le bouton **F3** ou **F4**.

- Heure de démarrage/arrêt : réglable par incréments de 5 minutes
 - * Pressez et maintenez le bouton enfoncé pour faire défiler rapidement les chiffres.
- Niveau de silence : Normal, Moyen, Silencieux



Pressez le bouton **CHOIX** pour enregistrer les réglages. Un écran de confirmation s'affiche.

Naviguer dans les écrans

- Pour revenir à l'écran de sélection du réglage changement/ jour de la semaine bouton **CHOIX**
- Pour revenir au Menu général bouton **MENU**
- Pour revenir à l'écran précédent bouton **RETOUR**

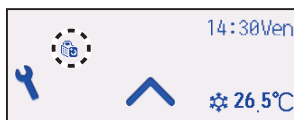

 apparaît sur l'Écran d'état et l'Écran principal de réglage en mode Complet lorsque le mode Silence unité extérieure est activé.

Réglages des fonctions

Réduit de nuit



Descriptions des fonctions

Cette fonction commence à chauffer lorsque le groupe piloté est arrêté et que la température de la pièce baisse en dessous de la limite inférieure programmée. En outre, cette fonction commande la réfrigération lorsque le groupe piloté est arrêté et que la température de la pièce s'élève au-dessus de la limite supérieure programmée.

La fonction de Réduit de nuit n'est pas disponible si le fonctionnement et le réglage de température sont commandés à partir de la télécommande.

Si la température de la pièce est mesurée au niveau du capteur de température de l'aspiration du climatiseur, la température peut ne pas être exacte lorsque le climatiseur est inactif ou quand l'air n'est pas propre. Dans ce cas, choisissez un capteur distant (PAC-SE40TSA/PAC-SE41TS-E) ou un capteur de la télécommande.

Fonctionnement des boutons

1



Sélectionnez « Réduit de nuit » dans le Menu timer et pressez le bouton **CHOIX**.

2



Les réglages actuels s'affichent.

Pressez le bouton **CHOIX** pour passer à l'écran des réglages.

3

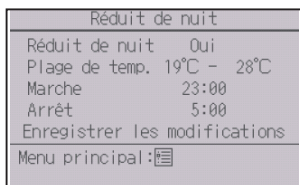

Placez le curseur avec le bouton **[F1]** ou **[F2]** sur le paramètre souhaité (Réduit de nuit Non (désactivé) / Oui (activé), Plage de température, heure de démarrage ou heure d'arrêt).

Modifiez le réglage avec le bouton **[F3]** ou **[F4]**.

- Plage de temp. : Les températures minimale (pour le chauffage) et maximale (pour la réfrigération) peuvent être réglées. La différence de température entre les limites inférieure et supérieure doit être égale ou supérieure à 4°C (8°F). La plage de réglage de température varie en fonction de l'unité intérieure connectée.
 - * Incréments de 1°C
- Heure de démarrage/arrêt : Réglable par incréments de 5 minutes
 - * Pressez et maintenez le bouton enfoncé pour faire défiler rapidement les chiffres.

Pressez le bouton **[CHOIX]** pour enregistrer les réglages.

Un écran de confirmation s'affiche.

Naviguer dans les écrans

- Pour revenir au Menu général bouton **[MENU]**
- Pour revenir à l'écran précédent bouton **[RETOUR]**

Réglages des fonctions



 apparaît sur l'Écran d'état et l'Écran principal de réglage en mode Complet lorsque la fonction Réduit de nuit est activée.

 apparaît lorsque le timer est désactivé par le système de contrôle centralisé.

Le Réduit de nuit ne fonctionne pas dans les cas suivants :

lorsque l'unité fonctionne, lorsque le Réduit de nuit est désactivé, en présence d'un défaut, lors de tests (dans le Menu SAV), lors du test des fonctions, lors du diagnostic de la télécommande, lorsque l'horloge n'est pas réglée, lors du réglage des fonctions, lorsque le système est contrôlé centralement (Lorsque la fonction ON/OFF, la fonction de réglage de la température ou la fonction timer à partir de la télécommande locale sont interdites).

Réglage des limites de la plage de température

Fonctionnement des boutons

1

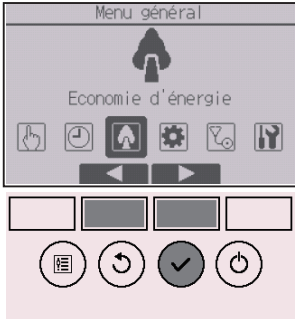

Sélectionnez « Économie d'énergie » dans le Menu général (voir page 24), et pressez le bouton **CHOIX**.

2

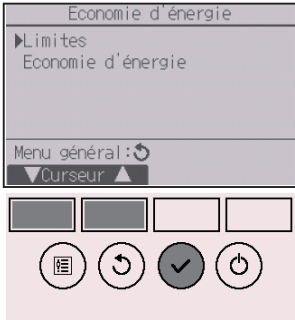

Placez le curseur sur « Limites » avec les boutons **F1** ou **F2** et pressez le bouton **CHOIX**.

Réglages des fonctions

3



Les réglages actuels s'affichent.

Placez le curseur sur « Temp.consigne » avec les boutons **F1** ou **F2** et pressez le bouton **CHOIX**.

4



L'écran permettant de régler la plage de température s'affiche.

Placez le curseur avec le bouton **F1** sur le paramètre souhaité (« Temp.consigne », «FroidDeshu », «Chaud » ou « Auto »).

5

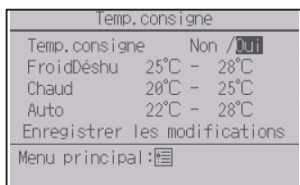
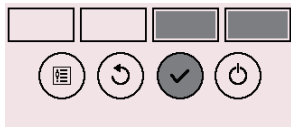

Modifiez le réglage avec le bouton **[F3]** ou **[F4]**.

- Temp.consigne : Non (sans limites) ou Oui (limitée)
- FroidDésahu : Température maximale et minimale (Incréments de 1°C)
- Chaud : Température maximale et minimale (Incréments de 1°C)
- Auto : Température maximale et minimale (Incréments de 1°C)

Réglage de la plage de température

Mode		Limite inférieure	Limite supérieure
FroidDésahu	*1 *3	19 à 30°C (67 à 87°F)	30 à 19°C (87 à 67°F)
Chaud	*2 *3	17 à 28°C (63 à 83°F)	28 à 17°C (83 à 63°F)
Automatique	*4	19 à 28°C (67 à 83°F)	28 à 19°C (83 à 67°F)

* La plage de réglage varie en fonction de l'unité connectée.

*1 Les plages de température pour les modes Froid, Déshumidification et Automatique (point de réglage double) peuvent être réglées.

*2 Les plages de température pour les modes Chaud et Automatique (point de réglage double) peuvent être réglées.

*3 Les plages de température pour les modes Chaud, Froid et Déshumidification doivent satisfaire aux conditions ci-dessous :

- Limite supérieure pour rafraîchir - limite supérieure pour chauffer \geq Différence de température minimale (varie selon le modèle d'unité intérieure)
- Limite inférieure pour rafraîchir - limite inférieure pour chauffer \geq Différence de température minimale (varie selon le modèle d'unité intérieure)

*4 La plage de température pour le mode Automatique (point de réglage simple) peut être réglée.

Pressez le bouton **[CHOIX]** pour enregistrer les réglages. Un écran de confirmation s'affiche.

Naviguer dans les écrans

- Pour revenir au Menu général bouton **[MENU]**
- Pour revenir à l'écran précédent bouton **[RETOUR]**



 apparaît sur l'Écran d'état et l'Écran principal de réglage en mode Complet lorsque la plage de température est limitée.

Réglages des fonctions

Limites

P

Fonction de verrouillage

Fonctionnement des boutons

Pour activer la fonction verrouillage, réglez le paramètre « Commande bloquée » sur « Oui ».

1



Affiche l'écran de réglage des limites. (Veuillez vous référer à la page 43.)

Placez le curseur sur « Commande bloquée » et pressez le bouton [CHOIX].

2

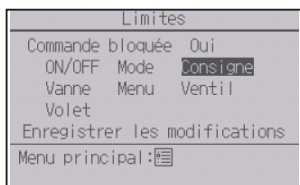

L'écran permettant de régler la fonction de verrouillage s'affiche.

Placez le curseur avec le bouton **[F1]** ou **[F2]** sur le paramètre souhaité (« Commande bloquée », « Emplacement », « ON/OFF », « Mode », « Consigne », « Menu », « Ventil », « Volet » ou « Vanne »).

Modifiez le réglage avec le bouton **[F3]** ou **[F4]**.

- Commande bloquée : Non (désactivé) / Oui (activé)
- Emplacement : « Indiv. » ou « Hôtel »
- ON/OFF : ON/OFF
- Mode : Réglage du mode de fonctionnement « - » / « verrouillé »
- Consigne : Programmation de la température
- Vanne : Réglage des vannes
- Menu : Réglage du menu
- Ventil : Réglage de la vitesse du ventilateur
- Volet : Réglage du volet

Lorsque « Hôtel » a été sélectionné pour le réglage « Emplacement » les fonctionnements suivants sont automatiquement verrouillés : Mode, Vanne, Menu et Volet.

Pressez le bouton **[CHOIX]** pour enregistrer les réglages.

Un écran de confirmation s'affiche.

Naviguer dans les écrans

- Pour revenir au Menu général bouton **[MENU]**
- Pour revenir à l'écran précédent bouton **[RETOUR]**

Réglages des fonctions



 apparaît sur l'Écran d'état et l'Écran principal de réglage en mode Complet lorsque la fonction verrouillage est activée.

Le guide de fonction correspondant à la fonction verrouillée sera supprimé.

Pour afficher le menu général lorsque le réglage du menu est verrouillé, pressez et maintenez enfoncé le bouton **Réglage** pour dix ou plus secondes. Entrez le mot de passe administrateur dans l'écran de saisie du mot de passe.

Retour automatique à la température programmée

Après l'activation de la fonction de Retour auto, lorsque le changement du mode de fonctionnement ou la fonction de ON/OFF est commandée à l'aide de cette télécommande, la température réglée retourne automatiquement à la température requise sans tenir compte de l'heure de réglage.

Fonctionnement des boutons

1

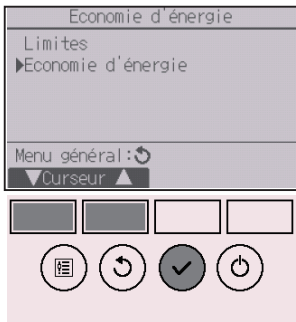

Sélectionnez « Économie d'énergie » dans le Menu d'économie d'énergie et pressez le bouton **[CHOIX]**.

2



Les réglages actuels s'affichent.

Placez le curseur sur « Retour auto » avec le bouton **[F1]** ou **[F2]** et pressez le bouton **[CHOIX]**.

Réglages des fonctions

3



L'écran permettant de régler le retour automatique à la température programmée s'affiche.

Placez le curseur avec le bouton [F1] ou [F2] sur le paramètre souhaité (« Retour auto », « Froid » ou « Chaud »).

4



Modifiez le réglage avec le bouton [F3] ou [F4].

- Retour auto : Non (désactivé) / Oui (activé)
- Froid : Réglage du timer de 30 à 120 minutes par incréments de 10 minutes.

La plage de réglage de la température est de 19 à 30°C (67 à 87°F) (Incréments de 1°C).

- Chaud : Réglage du timer de 30 à 120 minutes par incréments de 10 minutes.

La plage de réglage de la température est de 17 à 28°C (63 à 83°F) (Incréments de 1°C).

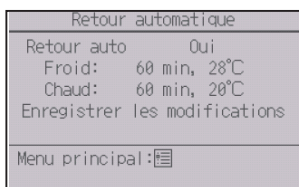

Pressez le bouton [CHOIX] pour enregistrer les réglages. Le mode « Froid » comprend les modes « Déshu. » et « Auto Froid » ; le mode « Chaud » comprend le mode « Auto Chaud ».

L'écran correspondant s'affiche.

Naviguer dans les écrans

- Pour revenir au Menu général bouton [MENU]
- Pour revenir à l'écran précédent bouton [RETOUR]

Les réglages pour le Timer ou la température programmée ne fonctionnent pas quand la plage de température est limitée, et quand le système est contrôlé centralement (quand le réglage de la plage de température à partir de la télécommande locale est interdit). Lorsque le système est contrôlé centralement (quand la fonction timer à partir de la télécommande locale est interdite), seul le réglage du timer ne fonctionnera pas.

Réglage du programme d'économie d'énergie

Fonctionnement des boutons

1



Affichez l'écran « Économie d'énergie ». (Veuillez vous référer à la page 49.)

Placez le curseur sur « Programmation » et pressez le bouton **[CHOIX]**.

2



L'écran d'affichage du programme apparaît.

Pressez le bouton **[F1]** ou **[F2]** pour afficher les réglages pour chaque jour de la semaine.

Pressez le bouton **[CHOIX]** pour passer à l'écran des réglages.

3

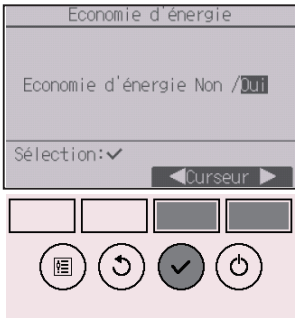

L'écran permettant d'autoriser (Oui) ou d'interdire (Non) le programme d'économie d'énergie s'affiche.

Sélectionnez « Non » ou « Oui » avec le bouton **[F3]** ou **[F4]**.

Pressez le bouton **[CHOIX]** pour accéder à l'écran de sélection du réglage changement/ jour de la semaine.

Réglages des fonctions

4



L'écran de réglage changement/jour de la semaine apparaît.

Jusqu'à quatre schémas peuvent être définis pour chaque jour.

Placez le curseur sur le jour de la semaine souhaité à l'aide du bouton [F1] ou [F2], puis pressez le bouton [F3] pour le sélectionner. (Plusieurs jours peuvent être sélectionnés.)

Pressez le bouton [CHOIX] pour passer à l'écran des réglages des schémas.

5



L'écran de réglage des schémas s'affiche.

Pressez le bouton [F1] pour déplacer le curseur sur le numéro de schéma désiré.

Placez le curseur avec le bouton [F2] sur le paramètre souhaité (heure de démarrage, heure d'arrêt, taux d'économie d'énergie) (dans cet ordre à partir de la gauche).

Modifiez le réglage avec le bouton [F3] ou [F4].

- Heure de démarrage/arrêt : réglable par incréments de 5 minutes

- * Pressez et maintenez le bouton enfoncé pour faire défiler rapidement les chiffres.

- Taux d'économie d'énergie : La plage de réglage est comprise entre 0% et 50 à 90% par incréments de 10%.

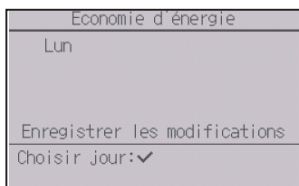

Pressez le bouton [CHOIX] pour enregistrer les réglages.

Un écran de confirmation s'affiche.

Plus la valeur est faible, plus l'économie d'énergie est importante.

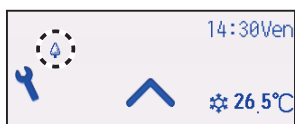

 s'affiche sur l'Écran d'état et sur l'Écran principal de réglage en mode Complet quand l'unité est utilisée en mode économie d'énergie.

Naviguer dans les écrans

- Pour revenir à l'écran de sélection du réglage changement/ jour de la semaine bouton **CHOIX**
- Pour revenir au Menu général bouton **MENU**
- Pour revenir à l'écran précédent bouton **RETOUR**

Réglages des fonctions

Horloge



Fonctionnement des boutons

1



Sélectionnez « Réglages initiaux » dans le Menu général (voir page 24), et pressez le bouton **[CHOIX]**.

L'heure doit avoir été réglée avant de procéder aux réglages suivants.

- ON/OFF timer
- Horloge hebdomadaire
- Mode silence unité extérieure
- Économie d'énergie
- Réduit de nuit

Si un système donné ne possède aucune télécommande de système, l'heure de l'horloge n'est pas corrigée automatiquement. Dans ce cas, corrigez l'heure de l'horloge régulièrement.

2



Placez le curseur sur « Réglage de base » avec le bouton **[F1]** ou **[F2]** et pressez le bouton **[CHOIX]**.

3



Sélectionnez « Horloge » avec le bouton **[F1]** ou **[F2]** et pressez le bouton **[CHOIX]**.

4



Placez le curseur sur « Horloge » avec les boutons **[F1]** ou **[F2]** et pressez le bouton **[CHOIX]**.

5



Placez le curseur sur le paramètre souhaité avec le bouton **[F1]** ou **[F2]** (année, mois, date, heure, ou minute).

Augmentez ou diminuez la valeur du paramètre sélectionné avec le bouton **[F3]** ou **[F4]** et pressez le bouton **[CHOIX]**.

Un écran de confirmation s'affiche.

Naviguer dans les écrans

- Pour revenir au Menu général bouton **[MENU]**
- Pour revenir à l'écran précédent bouton **[RETOUR]**

Réglages des fonctions

Heure d'été



Descriptions des fonctions

L'heure de début/fin de l'heure d'été peut être réglée. La fonction d'heure d'été sera activée selon les valeurs du réglage.

- Si un système donné possède une télécommande de système, désactivez ce réglage pour conserver l'heure correcte.
- Au début et à la fin de l'heure d'été, le timer peut se déclencher deux fois ou pas du tout.
- Cette fonction n'est pas opérationnelle si l'horloge n'a pas été réglée.

Fonctionnement des boutons

1



Sélectionnez « Horloge » dans le Menu réglage de base et pressez le bouton [CHOIX].

2



Placez le curseur sur « Heure d'été » avec le bouton [F1] ou [F2] et pressez le bouton [CHOIX].

3

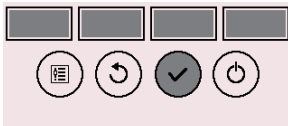
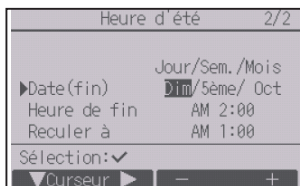
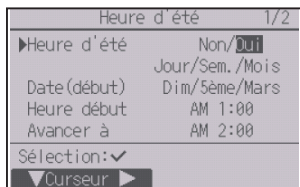

Placez le curseur sur les paramètres suivants à l'aide du bouton **[F1]** pour effectuer les réglages.

- **Heure d'été**
Sélectionnez « Non » (désactivée) ou « Oui » (activée) à l'aide du bouton **[F2]** Le réglage par défaut est « Non ».
 - **Date(début)*1**
Réglez le jour de la semaine, le numéro de la semaine et le mois à l'aide du bouton **[F3]** ou **[F4]**. Le réglage par défaut est « Dim/5ème/Mars ».
 - **Heure début**
Réglez l'heure de début de l'heure d'été à l'aide du bouton **[F3]** ou **[F4]**.
 - **Avancer à**
Réglez l'heure a laquelle l'horloge doit être avancée à l'aide du bouton **[F3]** ou **[F4]**.
 - **Date(fin)*1 (2e page)**
Réglez le jour de la semaine, le numéro de la semaine et le mois à l'aide du bouton **[F3]** ou **[F4]** Le réglage par défaut est « Dim/5ème/Oct ».
 - **Heure de fin (2e page)**
Réglez l'heure de fin de l'heure d'été à l'aide du bouton **[F3]** ou **[F4]**.
 - **Reculer à**
Réglez l'heure a laquelle l'horloge doit être reculée à l'aide du bouton **[F3]** ou **[F4]**.
- *1 Si « 5ème » est sélectionné comme numéro de semaine et qu'il n'existe pas de 5e semaine dans le mois sélectionné de l'année, le réglage est considéré comme étant « 4ème ».

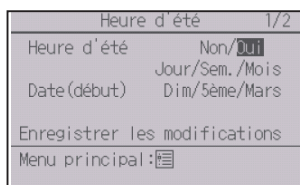

Pressez le bouton **[CHOIX]** pour enregistrer les réglages.

Un écran de confirmation s'affiche.

Naviguer dans les écrans

- Pour revenir au Menu général bouton **[MENU]**
- Pour revenir à l'écran précédent bouton **[RETOUR]**

Réglages des fonctions

Écran principal de réglage



Fonctionnement des boutons

1



Sélectionnez « Réglage de l'écran » dans le Menu des réglages initiaux et pressez le bouton **[CHOIX]**.

2



Placez le curseur sur « Écran principal de réglage » avec le bouton **[F1]** ou **[F2]** et pressez le bouton **[CHOIX]**.

3



Sélectionnez « Complet » ou « Basic » (voir page 10) avec le bouton **[F3]** ou **[F4]** et pressez le bouton **[CHOIX]**.

Un écran de confirmation s'affiche.

Naviguer dans les écrans

- Pour revenir au Menu général bouton **[MENU]**
- Pour revenir à l'écran précédent bouton **[RETOUR]**

Fonctionnement des boutons

1



Sélectionnez « Réglage de l'écran » dans le Menu des réglages initiaux et pressez le bouton **CHOIX**.

2

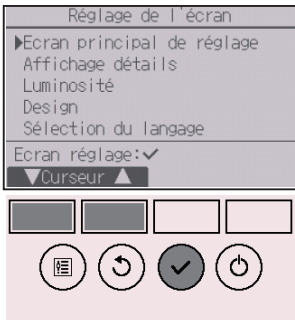

Placez le curseur sur « Écran principal de réglage » avec le bouton **F1** ou **F2** et pressez le bouton **CHOIX**.

3



Sélectionnez « Explic. icônes » avec le bouton **F1** ou **F2**, sélectionnez le réglage souhaité « Oui » ou « Non » avec le bouton **F3** or **F4**, puis pressez le bouton **CHOIX**.

Le réglage par défaut est « Oui ».

Naviguer dans les écrans

- Pour revenir au Menu général bouton **MENU**
- Pour revenir à l'écran précédent bouton **RETOUR**

Réglages des fonctions

4

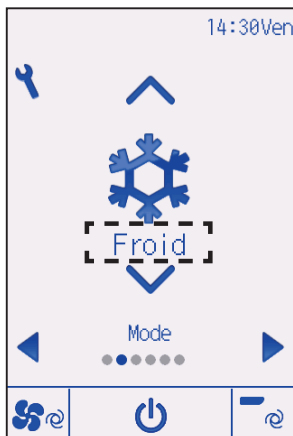

Lorsque « Oui » a été sélectionné, l'explication de l'icône du paramètre de réglage s'affichera à gauche comme indiqué.

Fonctionnement des boutons

1



Sélectionnez « Réglage de l'écran » dans le Menu des réglages initiaux et pressez le bouton **[CHOIX]**.

2



Placez le curseur sur « Luminosité » avec les boutons **[F1]** ou **[F2]** et pressez le bouton **[CHOIX]**.

3

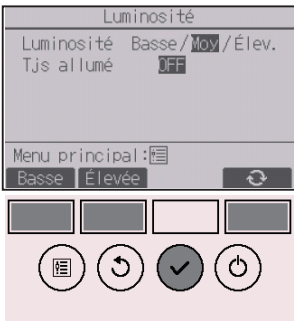

Réglez la luminosité avec le bouton **[F1]** ou **[F2]**. « ON » ou « OFF » peuvent être sélectionnés pour le réglage « Toujours allumé » avec le bouton **[F4]**.

En cas de sélection de « ON », le rétro-éclairage reste tamisé même après l'expiration du temps programmé.

Naviguer dans les écrans

- Pour revenir au Menu général bouton **[MENU]**
- Pour revenir à l'écran précédent bouton **[RETOUR]**

Réglages des fonctions

Sélection de la langue



Descriptions des fonctions

La langue désirée peut être choisie. Les langues disponibles sont : anglais, français, allemand, espagnol, italien, portugais, suédois, russe, grec, turque, hollandais, tchèque, hongrois et polonais.

Fonctionnement des boutons

1



Sélectionnez « Réglage de l'écran » dans le Menu des réglages initiaux et pressez le bouton **[CHOIX]**.

2



Placez le curseur sur « Sélection du langage » avec le bouton **[F1]** ou **[F2]** et pressez le bouton **[CHOIX]**.

3

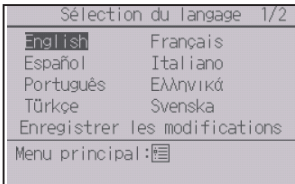

Placez le curseur sur la langue que vous désirez avec les boutons **F1** à **F4** et appuyez sur le bouton **CHOIX** pour enregistrer votre choix.

Lorsque l'unité est allumée pour la première fois, l'écran de sélection de langue est affiché. Sélectionnez la langue désirée. Le système ne démarrera pas avant qu'une langue ne soit choisie.

Un écran s'affiche pour vous informer que le réglage a été enregistré.

Naviguer dans les écrans

- Pour revenir au Menu général bouton **MENU**
- Pour revenir à l'écran précédent bouton **RETOUR**

Réglages des fonctions

Design



Fonctionnement des boutons

1



Sélectionnez « Réglage de l'écran » dans le Menu des réglages initiaux et pressez le bouton [CHOIX].

2



Placez le curseur sur « Design » avec les boutons [F1] ou [F2] et pressez le bouton [CHOIX].

3



Sélectionnez « Couleur » avec le bouton [F4].

- Couleur : La couleur de l'écran peut être sélectionnée (Veuillez vous référer à la page suivante.)
- Blanc : Écran monochrome (fond blanc)
- Noir : Écran monochrome (fond noir)

Après avoir sélectionné « Blanc » ou « Noir » pressez le bouton [CHOIX]. Après avoir sélectionné « Couleur » sélectionnez la couleur désirée en faisant référence à la page suivante.

4



Sélectionnez le paramètre suivant avec le bouton **[F1]** ou **[F2]** puis réglez la couleur désirée de l'écran pour chaque paramètre.

- Teinte de couleur : Réglez la teinte de couleur avec le bouton **[F3]** ou **[F4]**. (La plage de réglage est de -90 à 89.)
- Motif : Réglez la couleur avec le bouton **[F4]**.
- Rég. couleur : Sélectionnez « Caractère » ou « Arrière-plan » comme cible à laquelle appliquer la couleur avec le bouton **[F4]**.

La couleur échantillon sous les boutons des fonctions changera en fonction du réglage.

Sélectionnez la couleur désirée, et pressez le bouton **[CHOIX]**.

Naviguer dans les écrans

- Pour revenir au Menu général bouton **[MENU]**
- Pour revenir à l'écran précédent bouton **[RETOUR]**

Réglages des fonctions

Calibrage de l'écran tactile



Fonctionnement des boutons

1



Sélectionnez « Clavier tactile » dans le Menu des réglages initiaux et pressez le bouton **[CHOIX]**.

2



Placez le curseur sur « Calibrage du clavier tactile » avec le bouton **[F1]** ou **[F2]** et pressez le bouton **[CHOIX]**.

3



Un écran de confirmation s'affiche. Sélectionnez « Annule » ou « OK » avec le bouton **[F3]** ou **[F4]** et pressez le bouton **[CHOIX]**.

4

Touchez les points noirs dans l'ordre d'apparition à l'écran. Il y a neuf points en tout.

Touchez les points noirs avec en commençant en moins d'une minute, en commençant par celui dans l'angle supérieur gauche.

Touchez les neufs points noirs dans l'ordre d'apparition à l'écran.

Une fois tous les neuf points noirs touchés, le calibrage est terminé et l'écran revient au menu d'écran tactile.

- Si vous ne touchez pas l'écran tactile pour une minute, le calibrage sera supprimé et l'écran retournera automatiquement à l'écran précédent.
- Pour calibrer adéquatement l'écran tactile, utilisez un objet pointu mais non tranchant pour toucher les points
 - * Un objet tranchant peut endommager ou rayer l'écran tactile.

Réglages des fonctions

Nettoyage de l'écran tactile



Fonctionnement des boutons

1

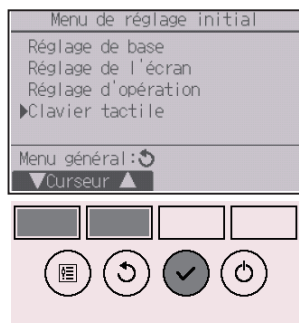

Sélectionnez « Clavier tactile » dans le Menu des réglages initiaux et pressez le bouton **[CHOIX]**.

2



Placez le curseur sur « Nettoyage du clavier tactile » avec le bouton **[F1]** ou **[F2]** et pressez le bouton **[CHOIX]**.

3

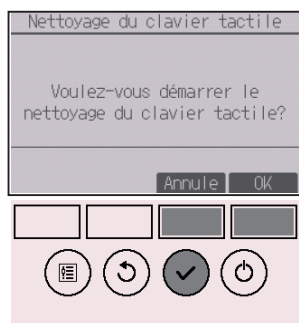

Un écran de confirmation s'affiche. Sélectionnez « Annule » ou « OK » avec le bouton **[F3]** ou **[F4]** et pressez le bouton **[CHOIX]**.

4

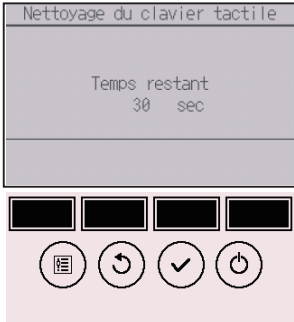

Cet écran permet à l'utilisateur de nettoyer l'écran tactile pendant 30 seconde pour éviter toute modification accidentelle des réglages.

L'écran retournera au menu écran tactile après 30 secondes.

- Nettoyez avec un chiffon doux, sec ou un tissu imbibé d'eau et d'un détergent doux ou un chiffon imprégné d'éthanol. N'utilisez pas des solvants acides, alcalins ou organiques.

Réglages des fonctions

Initialiser la télécommande



Descriptions des fonctions

La télécommande peut être initialisée à l'état d'expédition de l'usine. Remarquez que les données suivantes seront initialisées.

La télécommande démarrera automatiquement après l'initialisation.

Réglage du timer, réglage de l'horloge hebdomadaire, réglage de mode silence unité extérieure, réglage de l'économie d'énergie, réglage de l'option d'économie d'énergie, réglage de l'horloge, réglage de l'heure d'été, réglage de l'écran principal de réglage, réglage de la luminosité, réglage de l'affichage des détails, réglage du design, réglage du mode automatique, réglage du nom du modèle, réglage du numéro de série, réglage des informations du revendeur, informations défaut, mot de passe administrateur, mot de passe maintenance

Fonctionnement des boutons

1



Sélectionnez « Autres » dans le Menu SAV et pressez le bouton **[CHOIX]**.

2



Placez le curseur sur « Initialiser la télécommande » avec le bouton **[F1]** ou **[F2]** et pressez le bouton **[CHOIX]**.

3

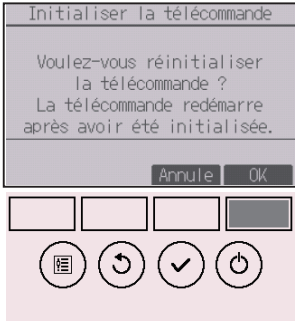

Sélectionnez « OK » avec le bouton **F4**.

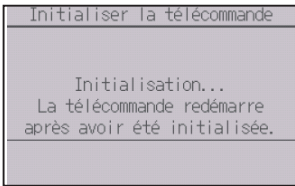

La télécommande démarrera automatiquement après l'initialisation.

Réglages des fonctions

Informations sur la télécommande



Descriptions des fonctions

Les informations sur la télécommande utilisée peuvent être vérifiées.

Fonctionnement des boutons

1



Sélectionnez « Autres » dans le Menu SAV et pressez le bouton **CHOIX**.

2



Placez le curseur sur « Informations télécommande » avec le bouton **F1** ou **F2** et pressez le bouton **CHOIX**.

3

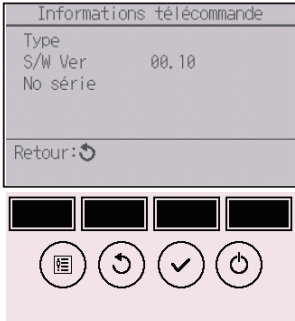

Le type, la version du logiciel e le numéro de série de la télécommande utilisée peuvent être vérifiés.

Résolution des problèmes

Information de défaut

Lorsqu'un défaut se produit, l'écran suivant s'affiche et la LED de fonctionnement clignote. Vérifiez l'état du défaut, arrêtez le système, et consultez votre revendeur.

Fonctionnement des boutons

1



Les paramètres code défaut, défaut unité, l'adresse du réfrigérant, le nom de modèle de l'unité, la date et l'heure à laquelle le défaut s'est produit et le numéro de série s'affichent.

Le nom du modèle et le numéro de série ne s'affichent que si ces informations ont été enregistrées.

Pressez le **F1** ou **F2** pour accéder à la page suivante.



Les informations de contact (numéro de téléphone du revendeur) s'affichent si ces informations ont été enregistrées.

2

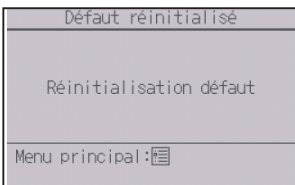
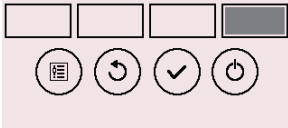
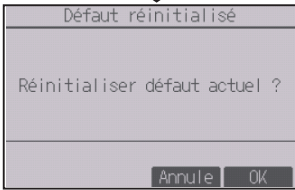
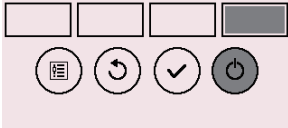
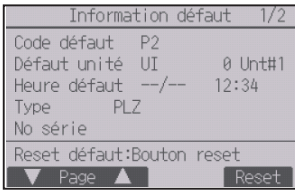

Pressez le bouton **F4** ou **ON/OFF** pour remettre à zéro le défaut qui s'est produit.

Les défauts ne peuvent pas être remis à zéro tant que la mise en marche ou l'arrêt sont interdits.

Sélectionnez « OK » avec le bouton **F4**.

Un écran de confirmation s'affiche.

Naviguer dans les écrans

- Pour revenir au Menu général bouton **MENU**

Résolution des problèmes

Vérification des informations défaut

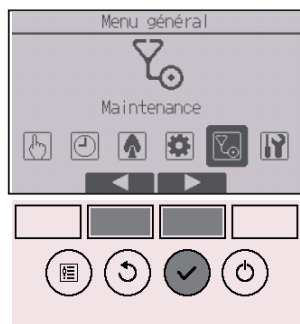

Même en l'absence de défauts, la page 2/2 des informations défauts (voir page 74) peut être consultée en sélectionnant dans le menu de fonctionnement.

Sélectionnez menu « Maintenance » dans le Menu général et pressez le bouton **[CHOIX]**.

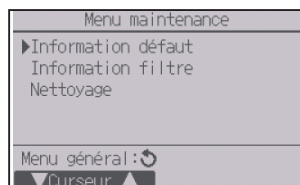

Pour afficher l'écran d'informations défaut, sélectionnez « Information défaut » dans le Menu maintenance.

Les défauts ne peuvent pas être remis à zéro.

Arrêt automatique en non occupation

L'écran suivant s'affichera pour le modèle du panneau du 3D i-See sensor lorsque l'unité est arrêtée à cause de la fonction Arrêt automatique en non occupation de l'option d'économie d'énergie.

Se référer au Manuel d'utilisation de l'unité intérieure pour le paramètre 3D i-See sensor.

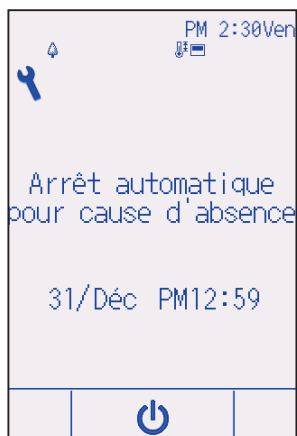

Maintenance

Informations sur le filtre



 apparaît sur l'Écran d'état et l'Écran principal de réglage en mode Complet quand les filtres doivent être nettoyés.

Lavez, nettoyez ou remplacez les filtres lorsque cette icône apparaît.

Veillez vous référer au Manuel d'instructions de l'unité intérieure pour plus de détails.

Fonctionnement des boutons

1

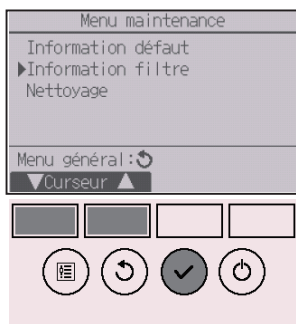

Sélectionnez « Information filtre » dans le Menu maintenance et pressez le bouton **[CHOIX]**.

2



Pressez le bouton **[F4]** pour réinitialiser le témoin d'état du filtre.

Reportez-vous au Manuel d'instructions de l'unité intérieure pour le nettoyage du filtre.

3

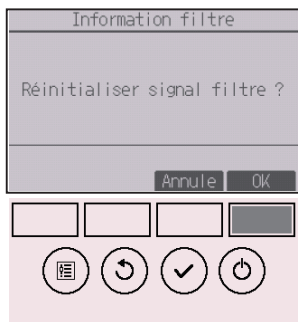

Sélectionnez « OK » avec le bouton **[F4]**.

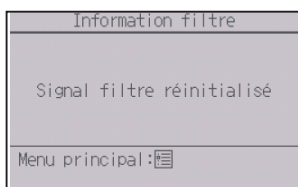

Un écran de confirmation s'affiche.

Naviguer dans les écrans

- Pour revenir au Menu général bouton **[MENU]**
- Pour revenir à l'écran précédent bouton **[RETOUR]**



Lorsque le  est affiché sur l'Écran d'état et sur l'Écran principal de réglage en mode Complet, le système est contrôlé centralement et le témoin d'état du filtre ne peut pas être remis à zéro.

Si deux ou plusieurs unités intérieures sont connectés, la fréquence de nettoyage du filtre de chaque unité peut être différent, en fonction du type de filtre.

L'icône  s'affiche lorsque le filtre de l'unité principale doit être nettoyé.

Lorsque le témoin d'état du filtre est remis à zéro, le temps de fonctionnement cumulé de toutes les unités est réinitialisé.

L'icône  est programmée pour apparaître après une certaine durée de fonctionnement, en fonction de l'hypothèse que les unités intérieures sont installées dans un espace avec une qualité d'air ordinaire. En fonction de la qualité de l'air, le filtre peut nécessiter un nettoyage plus fréquent.

Le temps cumulé au bout duquel le filtre doit être nettoyé dépend du modèle.

Caractéristiques

Caractéristiques de la télécommande

	Caractéristiques
Dimensions	Standard (PAR-CT01MAA(R)-SB/PAR-CT01MAA-S) : 65(W) × 120(H) × 14,1(D) mm (2 9/16 × 4 23/32 × 9/16 [in]) (non compris la partie qui dépasse)
	Premium (PAR-CT01MAA(R)-PB) : 68(W) × 120(H) × 14,1(D) mm (2 11/16 × 4 23/32 × 9/16 [in]) (non compris la partie qui dépasse)
Poids net	Standard (PAR-CT01MAA(R)-SB/PAR-CT01MAA-S) : 0,09 kg (13/64 lbs)
	Premium (PAR-CT01MAA(R)-PB) : 0,10 kg (7/32 lbs)
Tension d'alimentation	12 Vcc (fournie par les unités intérieures)
Consommation	0,6 W
Conditions d'utilisation	Température 0 ~ 40°C (32 ~ 104°F) Humidité 25 à 90%RH (sans condensation)
Matériau	Standard (PAR-CT01MAA(R)-SB/PAR-CT01MAA-S) Corps principal : ABS
	Premium (PAR-CT01MAA(R)-PB) Corps principal : ABS Plaque latérale : Aluminium

Liste des fonctions (au 1er octobre 2017)

○ : Présent × : Absent

	Fonction	CITY MULTI	Mr. SLIM	Mot de passe requis
Puissance	ON/OFF	○	○	-
Réglages	Mode de fonctionnement	○	○	-
	Mode Automatique (deux points de réglage)	○	○	-
	Température programmée	○	○	-
	Vitesse du ventilateur	○	○	-
	Vanne	○	○	-
	Volet	○	○	-
	Ventilation	○	○	-
Menu opération	Forte puissance	×	○	-
	Angle de volet manuel	○	○	-
	3D i-See sensor	○	○	-
Menu timer	Timer (ON/OFF timer)	○	○	administrateur
	Timer (Arrêt auto timer)	○	○	administrateur
	Horloge hebdomadaire	○	○	administrateur
	Mode silence unité extérieure	○	○	administrateur
	Réduit de nuit	○	○	administrateur
Menu économies d'énergie	Limites de la plage de température	○	○	administrateur
	Fonction de verrouillage	○	○	administrateur
	Retour automatique	○	○	administrateur
	Programmation	×	○	administrateur
Menu Réglages initiaux	Horloge	○	○	administrateur
	Réglage du format d'affichage de l'heure	○	○	administrateur
	Heure d'été	○	○	administrateur
	Écran principal de réglage	○	○	administrateur
	Explication des icônes	○	○	administrateur
	Luminosité	○	○	administrateur
	Sélection de la langue	○	○	administrateur
	Design	○	○	administrateur
	Calibrage de l'écran tactile	○	○	administrateur
	Nettoyage de l'écran tactile	○	○	administrateur
Mot de passe (administrateur)	○	○	administrateur	
Menu SAV	Initialiser la télécommande	○	○	maintenance
	Informations sur la télécommande	○	○	maintenance
	Test fonctions	○	○	maintenance
	Entrée des informations sur le modèle	○	○	maintenance
	Entrée des informations sur le revendeur	○	○	maintenance
	Réglage des fonctions	○	○	maintenance
	Maintenance simplifiée	×	○	maintenance
Mot de passe (maintenance)	○	○	maintenance	
Menu maintenance	Descente automatique façade	○	○	-
	Informations de défaut	○	○	-
	Informations sur le filtre	○	○	-

* Les fonctions prises en charge varient selon le modèle de l'unité.

Caractéristiques

Liste des fonctions compatibles / incompatibles entre elles

	Forte puissance	ON/OFF timer	Arrêt auto timer	Horloge hebdomadaire	Mode silence unité extérieure	Plage de température	Fonction de verrouillage	Retour automatique	Programme d'économies d'énergie	Réduit de nuit
Forte puissance		○	○	○	△ 1	○	△ 2	○	△ 1	○
ON/OFF timer	○		○	× 1	○	○	○	○	○	△ 3
Arrêt auto timer	○	○		○	○	○	○	○	○	△ 4
Horloge hebdomadaire	○	× 1	○		○	○	○	○	○	△ 5
Mode silence unité extérieure	△ 1	○	○	○		○	○	○	○	○
Plage de température	○	○	○	○	○		○	× 2	○	△ 6
Fonction de verrouillage	△ 2	○	○	○	○	○		○	○	○
Retour automatique	○	○	○	○	○	× 2	○		○	△ 7
Programme d'économies d'énergie	△ 1	○	○	○	○	○	○	○		○
Réduit de nuit	○	△ 3	△ 4	△ 5	○	△ 6	○	△ 7	○	

○ : Compatibles × : Incompatibles △ : Limitées

△ 1 : Cette fonction est activée après la fin du fonctionnement à forte puissance, car celui-ci a la plus grande priorité.

△ 2 : Cette fonction ne peut pas fonctionner si certaines fonctions sont verrouillées.

△ 3 : Le Réduit de nuit ne peut pas être utilisé lorsque l'unité fonctionne à travers le réglage du ON/OFF timer.

△ 4 : La fonction d'arrêt automatique ne peut pas être utilisée pour le Réduit de nuit.

△ 5 : Le Réduit de nuit ne peut pas être utilisé lorsque l'unité fonctionne à travers le réglage de l'horloge hebdomadaire.

△ 6 : Le réglage de la plage de température ne peut pas être utilisé pour le Réduit de nuit.

△ 7 : La fonction de retour automatique ne peut pas être utilisée pour le Réduit de nuit.

× 1 : L'horloge hebdomadaire n'est pas actif parce que le ON/OFF timer a la plus grande priorité.

× 2 : La fonction de retour automatique ne peut pas être utilisée parce que le réglage de la plage de température a la plus grande priorité.

Sistema de control CITY MULTI
y aparatos de aire acondicionado Mitsubishi Mr. SLIM

Español

Controlador remoto táctil MA

PAR-CT01MAA-PB

PAR-CT01MAA-SB

PAR-CT01MAA-S

PAR-CT01MAR-PB

PAR-CT01MAR-SB

Libro de instrucciones



Antes de utilizar el producto, lea detenidamente las instrucciones en este manual para utilizarlo correctamente.

Conserve las instrucciones para futuras consultas.

Asegúrese de entregar este CD-ROM y el Manual de instalación a cualquier usuario futuro.



Para asegurar un funcionamiento seguro y correcto del controlador remoto, éste debe ser instalado solamente por personal técnico cualificado.

Contenidos

Precauciones de seguridad	4
Componentes del controlador	6
Interfaz del controlador - Pantalla de estado/Pantalla principal...	6
Interfaz del controlador - Pantalla Menú	8
Pantalla - Pantalla Estado/Pantalla principal	10
Estructura del menú e iconos	12
Estructura del menú	12
Explicación de los iconos	15
Operaciones básicas	16
ENCENDIDO/APAGADO	16
Configuración de modo de funcionamiento, temperatura, velocidad del ventilador, lama, deflector y ventilación (Lossnay) ..	17
Navegación por el menú	22
Lista del Menú principal	22
Navegación por el menú principal	24
Opciones de configuración de las funciones	25
Super	25
Ángulo lama manual	26
Programador (Programador On/Off)	29
Programador (Programador Auto-Off)	32
Programador semanal	34
Unidad exterior modo silencioso	37
Modo noche	40
Restricción	43
Ahorro energía	49
Hora	54
Horario de verano	56
Pantalla principal	58
Explicación de los iconos	59
Brillo	61
Seleccione el idioma	62
Diseño	64
Calibración de la pantalla táctil	66
Limpieza de la pantalla táctil	68
Inicializar controlador remoto	70
Información de controlador remoto	72
Resolución de problemas	74
Información de errores	74
Auto-OFF no ocupación	77
Mantenimiento	78
Información de filtros	78
Especificaciones	80
Especificaciones del controlador	80
Lista de funciones (con fecha del 1 de octubre de 2017) ..	81
Lista de funciones que pueden o no ser utilizadas en combinación ..	82

Precauciones de seguridad

- Lea detenidamente las siguientes precauciones de seguridad antes de utilizar la unidad.
- Para garantizar la seguridad, siga detenidamente estas precauciones.

 ADVERTENCIA	Indica un riesgo de muerte o de lesiones graves.
 PRECAUCIÓN	Indica un riesgo de lesión seria o daños materiales.

- Una vez leído este manual, entrégueselo al usuario final para que lo pueda consultar en el futuro.
- Guarde este manual para futuras consultas y acuda a él cuando sea necesario. Este manual debe estar disponible para aquellos que reparen o desplacen el controlador. Asegúrese de pasar el manual a los futuros usuarios.

Precauciones generales

ADVERTENCIA

No instale la unidad en un lugar donde haya grandes cantidades de aceite, vapor, disolventes orgánicos o gases corrosivos como el gas sulfúrico, o donde se usen frecuentemente soluciones ácidas, alcalinas o aerosoles. Estas sustancias pueden mermar el rendimiento de la unidad o hacer que ciertas partes de la unidad se corroan, lo que podría provocar descargas eléctricas, anomalías, humo o incendios.

Para reducir el riesgo de cortocircuitos, fugas de corriente, descargas eléctricas, anomalías, humo o incendios, no limpie el controlador con agua ni ningún otro líquido.

Para reducir el riesgo de descargas eléctricas, anomalías, humo o incendios, no toque los interruptores/botones ni ninguna otra parte eléctrica con las manos húmedas.

Al desinfectar la unidad con alcohol, ventile la habitación adecuadamente. Los humos del alcohol alrededor de la unidad pueden provocar un incendio o explosión al encender la unidad.

Para reducir el riesgo de lesiones o de descargas eléctricas, pare el funcionamiento del controlador y cúbralo antes de pulverizar cualquier producto químico a su alrededor.

Para reducir el riesgo de lesiones o de descargas eléctricas, pare el funcionamiento del controlador y desconéctelo de la toma de corriente antes de limpiarlo, realizar labores de mantenimiento o revisarlo.

En caso de que se presente alguna anomalía (por ejemplo olor a quemado), apague la unidad, desenchufe la alimentación y consulte a su distribuidor. El uso continuado del producto puede resultar en descargas eléctricas, mal funcionamiento o incendios.

Instale correctamente todas las cubiertas necesarias para evitar que el controlador entre en contacto con la humedad y el polvo. La acumulación de polvo y agua puede provocar descargas eléctricas, humo o incendios.

PRECAUCIÓN

Para reducir el riesgo de incendio o explosión, no coloque materiales inflamables ni utilice pulverizadores inflamables cerca del controlador.

Para reducir el riesgo de daño del controlador, no pulverice insecticidas directamente en el controlador ni use pulverizadores inflamables.

Para reducir el riesgo de contaminación medioambiental, consulte a una agencia autorizada para eliminar de manera correcta el controlador remoto.

Para reducir el riesgo de descargas eléctricas o anomalías, no toque la pantalla táctil, los interruptores ni los botones con objetos afilados o cortantes.

Para reducir el riesgo de lesiones y de descargas eléctricas, evite el contacto con bordes afilados.

Para reducir el riesgo de lesiones, lleve equipos de protección cuando trabaje en el controlador.

Para evitar lesiones por vidrios rotos, no ejerza demasiada fuerza en las partes de vidrio.

Precauciones a la hora de mover o reparar el controlador

ADVERTENCIA

El controlador deberá ser reparado o movido sólo por personal cualificado. No intente desmontar o modificar el controlador.

Una reparación o instalación incorrecta podría provocar lesiones, descargas eléctricas o incendios.

PRECAUCIÓN

Para reducir el riesgo de cortocircuito, descargas eléctricas, incendio o mal funcionamiento, no toque el panel del circuito con herramientas ni con sus manos, y no permita que se acumule polvo en el panel del circuito.

Precauciones adicionales

Para evitar dañar el controlador, utilice las herramientas adecuadas para instalar, inspeccionar o reparar el controlador.

Este controlador ha sido diseñado para su uso exclusivo con el sistema de gestión de edificios de Mitsubishi Electric. El uso de este controlador con otros sistemas o para otras finalidades podría provocar anomalías.

No está previsto el uso de este equipo por personas (incluidos los niños) con capacidad física, sensorial o mental disminuida, o carentes de conocimientos y experiencia, a menos que lo hagan siguiendo las instrucciones de uso bajo la supervisión de una persona responsable de su seguridad. Es necesario vigilar a los niños para impedir que jueguen con la unidad.

Para evitar la decoloración, no utilice benceno, disolventes o productos químicos para limpiar el controlador. Para limpiar el controlador, pásele un trapo humedecido en un detergente suave, elimine el detergente con un trapo húmedo y, por último, pase un trapo seco.

Para evitar dañar el controlador, protéjalo contra la electricidad estática.

Este equipo está diseñado para expertos o usuarios formados de tiendas, de la industria de la iluminación y de granjas, o a personal lego para uso comercial.

Si el cable de alimentación está dañado, para evitar riesgos, la sustitución del mismo debe confiarse al fabricante, su agente de reparaciones o personas igualmente cualificadas.

Componentes del controlador

Interfaz del controlador - Pantalla de estado/Pantalla principal

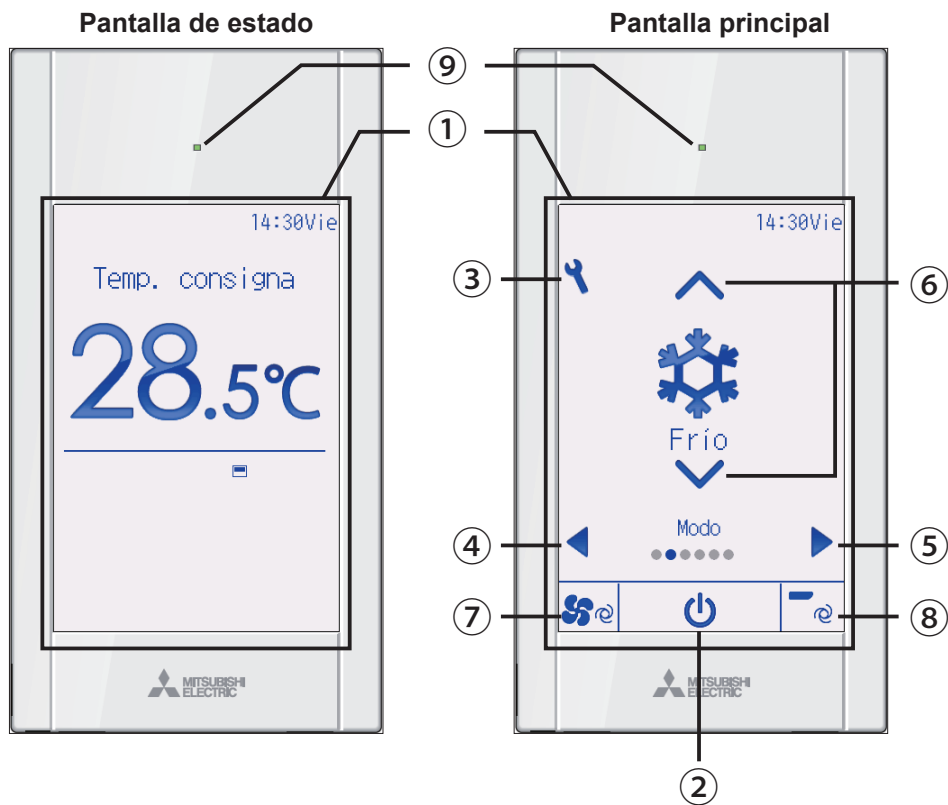

① Panel táctil y pantalla LCD en color con retroalimentación

Aparecerá la configuración de operaciones. Cuando la luz de fondo esté apagada, al pulsar en cualquier área se pasará a la pantalla de estado. Cuando se muestre la pantalla de estado, al pulsar en cualquier área se pasará a la pantalla principal.

② Botón ENCENDIDO/APAGADO

Presione para ENCENDER/APAGAR la unidad interior.

③ Botón Ajuste

Presione para ir al Menú principal. Cuando el funcionamiento del menú esté bloqueado, se requiere una contraseña de administrador.

④ Botón ◀

Presione para cambiar entre los elementos de configuración en el siguiente orden: deflector, ventilación, lama, velocidad del ventilador, modo de funcionamiento y temperatura preestablecida.

⑤ Botón ▶

Presione para cambiar entre los elementos de configuración en este orden: temperatura preestablecida, modo de funcionamiento, velocidad del ventilador, lama, ventilación y deflector.

⑥ Botón ▲ ▼

Presione para cambiar el contenido de la configuración seleccionada en los pasos ④ y ⑤ anteriores.

⑦ Botón de acceso rápido a la velocidad del ventilador

Presione para acceder directamente a la pantalla de configuración de la velocidad del ventilador.

⑧ Botón de acceso rápido a las lamas

Presione para acceder directamente a la pantalla de configuración de la lama.

⑨ Lámpara de ENCENDIDO/APAGADO

Esta lámpara se ilumina en verde mientras la unidad esté en funcionamiento, a menos que la configuración de "Ilumin. LED" esté establecida en "No". Parpadea cuando se está iniciando el controlador remoto o cuando hay un error.

Si la operación de ENCENDIDO/APAGADO está bloqueada, ② no se mostrará.

Cuando se cambia el valor de esta opción de configuración mediante el botón ④ o ⑤, si la operación de la opción de configuración está bloqueada, el elemento no se mostrará.

Si la operación de la velocidad del ventilador o de la lama está bloqueada, el elemento ⑦ o ⑧ no se mostrará.

El contenido de la configuración no puede cambiarse con el botón ⑥ si el elemento de configuración se controla de forma centralizada mediante el controlador del sistema.

Componentes del controlador

Interfaz del controlador - Pantalla Menú

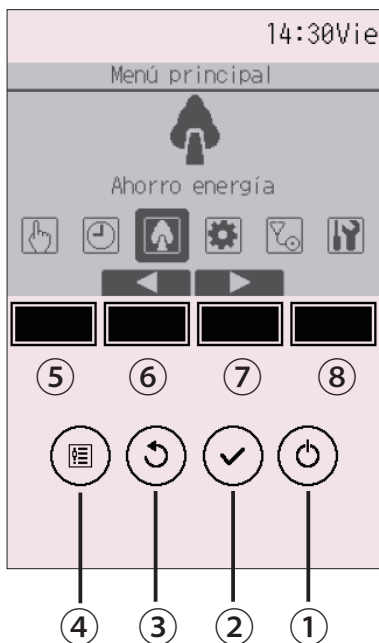

① Botón **ON/OFF**

Presione para ENCENDER/APAGAR la unidad interior.

② Botón **ACEPTAR**

Presione para guardar la configuración.

③ Botón **VOLVER**

Pulse para volver a la pantalla anterior. Cuando se muestra el menú principal, al presionar este botón se mostrará la pantalla de estado.

④ Botón **MENÚ**

Página 24

Presione para ir al Menú principal.

⑤ Botón de función **F1**

Pantalla Menú: El botón de función varía según la pantalla.

⑥ Botón de función **F2**

Menú principal: Presione para mover el cursor hacia la izquierda.

Pantalla Menú: El botón de función varía según la pantalla.

⑦ Botón de función **F3**

Menú principal: Presione para mover el cursor hacia la derecha.

Pantalla Menú: El botón de función varía según la pantalla.

⑧ Botón de función **F4**

Pantalla Menú: El botón de función varía según la pantalla.

Las funciones de los botones de función cambian dependiendo de la pantalla. Consulte la guía de funciones de los botones que aparece en la parte inferior del LCD para ver las funciones que tienen en cada una de las pantallas.

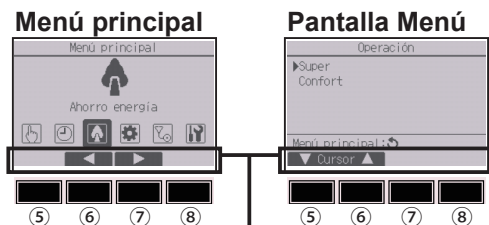

Componentes del controlador

Pantalla - Pantalla Estado/Pantalla principal

La pantalla de estado y la pantalla principal se pueden visualizar en dos modos diferentes: "Completo" y "Básico".

De forma predeterminada, se visualiza el modo "Completo". Consulte la página 58 para saber cómo cambiar el modo.

Modo completo

* Todos los iconos se muestran para explicar su significado.

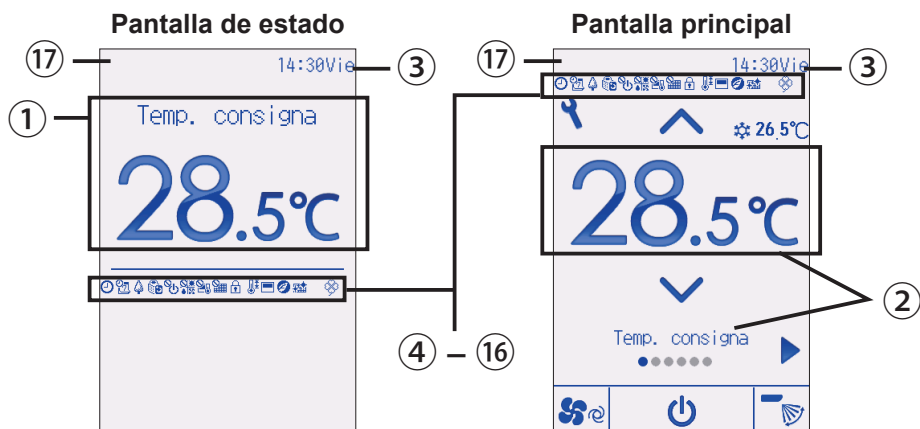

Modo básico

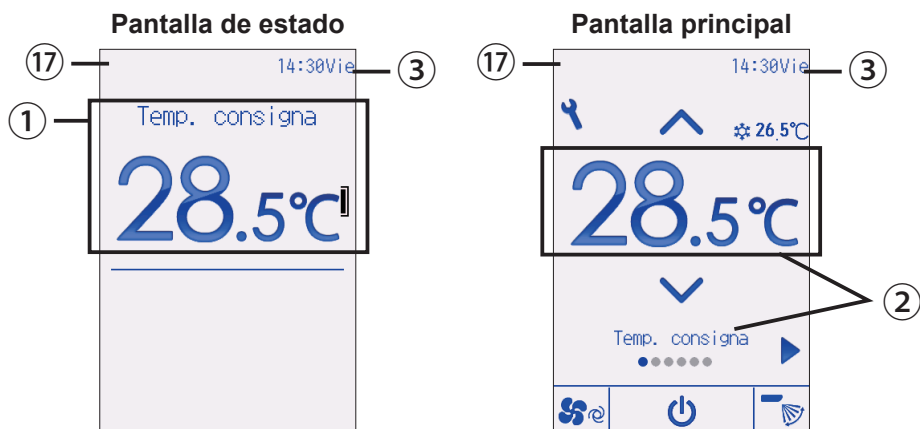

① Temperatura preestablecida o temperatura de la sala

Aquí se muestra la temperatura preestablecida o la temperatura de la sala. (Consulte el Manual de instalación).

② Opción de configuración y contenido de configuración **Página 17**

Las opciones de configuración “Temperatura preestablecida” ↔ “Modo de funcionamiento” ↔ “Velocidad del ventilador” ↔ “Lama” ↔ “Ventilación” ↔ “Deflector” y su contenido se muestran aquí.

Aparece “Control centralizado” durante cierto periodo de tiempo cuando se maneja un elemento controlado de forma centralizada.

③ Hora

Aquí aparece la hora actual. (Consulte el Manual de instalación).

④ **Página 29, 32, 40**

Aparece cuando está habilitada la función “Programador On/Off” (Página 29), “Modo noche” (Página 40) o “Programador Auto-Off” (Página 32).

 aparece al deshabilitar el programador mediante el sistema de control centralizado.

⑤ **Página 34**

Aparece cuando se activa el programador semanal.

⑥ **Página 51**

Aparece mientras la unidad está funcionando en modo ahorro energía. (No aparecerá en algunos modelos de unidades interiores)

⑦ **Página 37**

Aparece mientras las unidades exteriores están funcionando en modo silencioso.

⑧

Aparece cuando el ENCENDIDO/ APAGADO se controla a nivel central.

⑨

Aparece cuando el modo de funcionamiento se opera a nivel central.

⑩

Aparece cuando la temperatura preestablecida se controla a nivel central.

⑪

Aparece cuando la función de restauración del filtro se controla a nivel central.

⑫

Página 46

Aparece cuando los botones están bloqueados.

⑬

Página 43

Aparece cuando se restringe el rango de temperatura preestablecida.

⑭

Aparece cuando el termistor incorporado en el controlador remoto está activado para controlar la temperatura de la habitación(a).

 aparece cuando el termistor de la unidad interior se activa para controlar la temperatura de la sala.

⑮

Aparece cuando se realiza una operación de ahorro energía utilizando una función “3D i-See sensor”.

⑯

Página 78

Indica cuándo necesita mantenimiento el filtro.

⑰ **Pantalla de error preliminar**

Aparece un código de error durante el error preliminar.

Estructura del menú e iconos

Estructura del menú

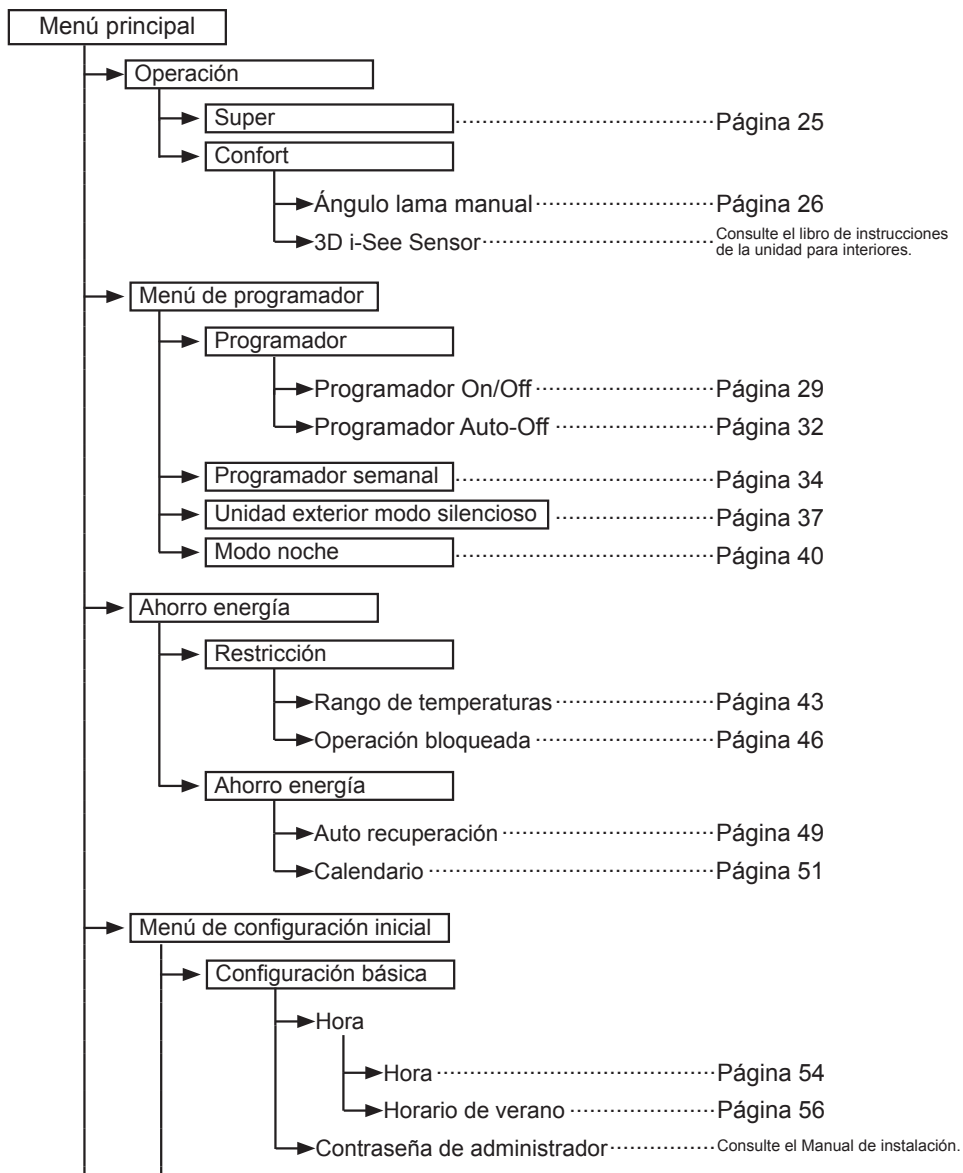

→	Configuración de pantalla	
→	Pantalla principal	Página 58
→	Detalles de pantalla (Explicación de iconos, etc.)	Consulte el Manual de instalación.
→	Brillo	Página 61
→	Seleccione el idioma	Página 62
→	Diseño	Página 64
→	Configuración de funcionamiento	
→	Modo automático	Consulte el Manual de instalación.
→	Pantalla táctil	Página 66
→	Menú de mantenimiento	
→	Información de errores	Página 74
→	Información de filtros	Página 78
→	Limpieza	
→	Panel autodescendente	Consulte el libro de instrucciones incluido con el panel de elevación automática.
→	Funcionamiento descendente	Consulte el libro de instrucciones incluido con el panel de elevación automática.
→	Ajuste descendente	Consulte el libro de instrucciones incluido con el panel de elevación automática.
→	Menú de revisión	
→	Menú de modo de prueba	
→	Modo prueba	Consulte el Manual de instalación de la unidad para interiores.
→	Modo prueba de bomba de drenaje	Consulte el Manual de instalación de la unidad para interiores.
→	Información de mantenimiento	Consulte el Manual de instalación de la unidad interior.
→	Introducir modelo de unidad	Consulte el Manual de instalación de la unidad para interiores.
→	Introducir número de serie	Consulte el Manual de instalación de la unidad para interiores.
→	Introducir teléfono de contacto	Consulte el Manual de instalación de la unidad para interiores.
→	Inicializar información de mantenimiento	Consulte el Manual de instalación de la unidad interior.

Estructura del menú e iconos

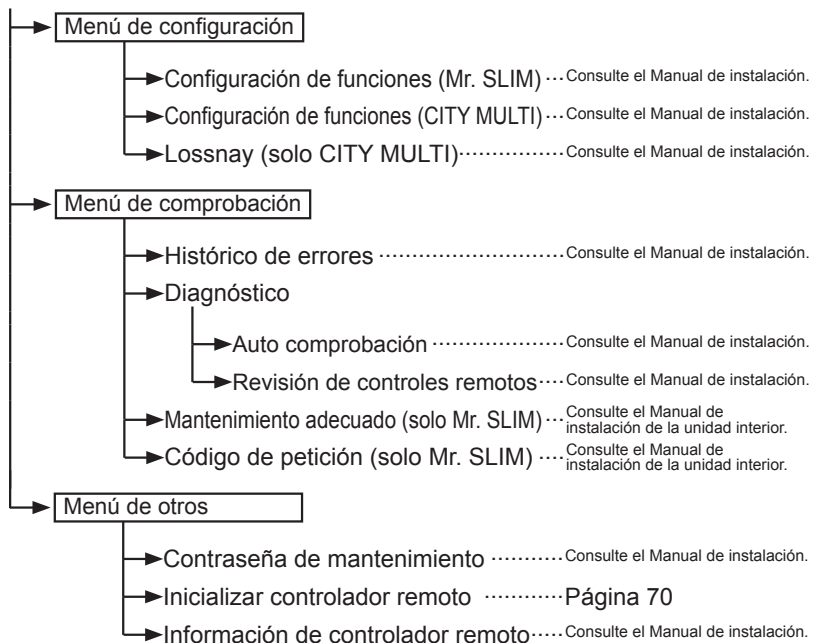

No todas las funciones están disponibles en todos los modelos de unidades interiores.

Explicación de los iconos

Funcionamiento del controlador

Programador



La siguiente tabla resume los iconos cuadrados utilizados en este manual.



Para cambiar la configuración, debe introducir en la pantalla de introducción de contraseña la contraseña del administrador o del usuario de mantenimiento. No hay ninguna configuración que se pueda hacer sin este proceso.

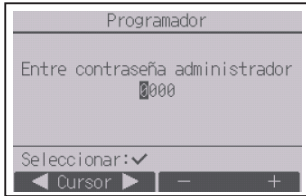

F1 F2 F3 F4

- F1**: Presione para mover el cursor hacia la izquierda.
- F2**: Presione para mover el cursor hacia la derecha.
- F3**: Presione para disminuir el valor en 1.
- F4**: Presione para aumentar el valor en 1.

* Los cambios no se podrán realizar si no se ha introducido la contraseña correcta.



Indica configuraciones que solamente se pueden cambiar con las unidades en funcionamiento.



Indica configuraciones que solamente se pueden cambiar con las unidades desconectadas.



Indica configuraciones que solamente se pueden cambiar con las unidades funcionando en modo Frío, Calor o modo Automático.



Indica funciones que no están disponibles con los botones bloqueados o cuando el sistema está controlado a nivel central.

Operaciones básicas

ENCENDIDO/APAGADO



Funcionamiento del botón

ENCENDER



Presione el botón **ENCENDIDO/APAGADO**.

La lámpara de ENCENDIDO/APAGADO se iluminará en verde y comenzará a funcionar la unidad.

Si "Ilumin. LED" está establecido en "No", la lámpara de ENCENDIDO/APAGADO no se encenderá.

Botón **ENCENDIDO/APAGADO**

APAGAR



Presione de nuevo el botón **ENCENDIDO/APAGADO**.

La lámpara de ENCENDIDO/APAGADO se apagará y la unidad dejará de funcionar.



Funcionamiento del botón

Modo de funcionamiento



Cada vez que se presiona el botón ▼ o ▲ se pasa por los siguientes modos de funcionamiento.

Seleccione el modo de funcionamiento deseado.



Frío



Secar



Ventilador



Auto



Calor

- Los modos de funcionamiento que no estén disponibles para el modelo de unidad interior conectado no aparecerán en la pantalla.

Qué significa que parpadee el icono de modo

El icono de modo parpadeará cuando las otras unidades interiores en el mismo sistema de refrigeración (conectado a la misma unidad exterior) están funcionando ya en un modo diferente. En este caso, el resto de la unidad del mismo grupo podrá funcionar solamente en el mismo modo.

<Modo "Auto" (punto de ajuste doble)>

Cuando el modo de funcionamiento esté establecido en el modo "Auto" (punto de ajuste doble), se pueden ajustar dos temperaturas preestablecidas (una para enfriamiento y otra para calentamiento). Dependiendo de la temperatura de la sala, la unidad interior operará automáticamente en el modo "Frío" o "Calor" y mantendrá la temperatura de la sala dentro del rango preestablecido.

El siguiente gráfico muestra el patrón de operación de la unidad interior operada en el modo Auto (punto de ajuste doble).

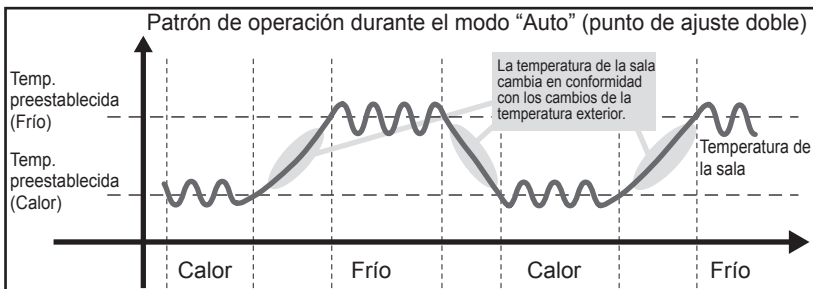

Operaciones básicas

Temperatura preestablecida

<“Frío”, “Secar”, “Calor” y “Auto” (punto de ajuste simple)>



Presione el botón ▼ para disminuir la temperatura preestablecida y el botón ▲ para aumentarla.

- Consulte la tabla de la página 19 para ver el rango de temperatura seleccionable para los diferentes modos de funcionamiento.
- El rango de temperaturas preestablecido no se puede configurar para el funcionamiento del Ventilador/ Ventilación.
- La temperatura preestablecida será visualizada en grados Centígrados en incrementos de 0,5 o 1 grado, o en grados Fahrenheit, en función del modelo de unidad interior y del ajuste del modo de pantalla del controlador remoto.

<Modo “Auto” (punto de ajuste doble)>

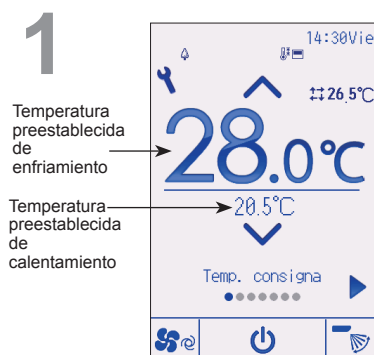

Aparecerán las temperaturas preestablecidas actuales.

Cada vez que se presiona el botón ◀ o ▶, se pasa de a las temperaturas preestablecidas de frío y calor.

2

Temperatura preestablecida de enfriamiento

Temperatura preestablecida de calentamiento



Presione el botón ▼ para disminuir la temperatura seleccionada y el botón ▲ para aumentarla.

- Consulte la tabla siguiente para ver el rango de temperaturas seleccionable para los diferentes modos de funcionamiento.
- Los ajustes de la temperatura preestablecida para frío y calor en el modo Auto (punto de ajuste doble) se utilizan igualmente mediante los modos Frío/Secar y Calor.
- Las temperaturas preestablecidas para enfriamiento y calentamiento en el modo Auto (punto de ajuste doble) deben cumplir las siguientes condiciones:

- La temperatura de frío preestablecida es superior a la temperatura de calor preestablecida.
- El requisito mínimo de diferencia de temperatura entre las temperaturas preestablecidas de frío y calor (varía en función de los modelos de las unidades interiores conectadas) se ha cumplido.
- Si las temperaturas preestablecidas se ajustan de tal modo que no cumplen con el requisito mínimo de diferencia de temperatura, ambas temperaturas preestablecidas se modificarán automáticamente dentro de los rangos de ajuste permisibles.

Rango de temperatura preestablecida configurable

Modo de funcionamiento	Rango de temperatura preestablecida
Frío/Secar	19 ~ 30°C (67 ~ 87°F)
Calor	17 ~ 28°C (63 ~ 83°F)
Auto (punto de ajuste simple)	19 ~ 28°C (67 ~ 83°F)
Auto (puntos de ajuste dobles)	[Frío] Rango de temperatura preestablecida para el modo Frío [Calor] Rango de temperatura preestablecida para el modo Calor
Ventilador/Ventilación	No se puede configurar

El rango de temperatura que se puede configurar varía dependiendo del modelo de unidad interior.

Operaciones básicas

Velocidad del ventilador

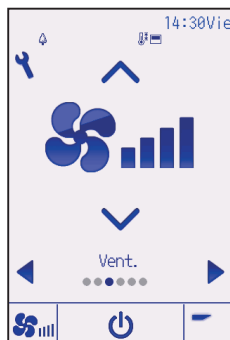

Cada vez que se presiona el botón ▼ o ▲ se pasa por las siguientes velocidades de ventilador.

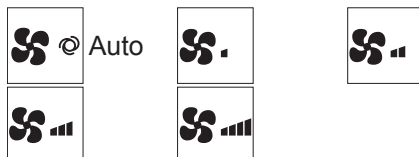

- Las velocidades de ventilador disponibles dependen de los modelos de unidades interiores conectados.

Configuración de la lama



(Ejemplo de pantalla en CITY MULTI)

Cada vez que se presiona el botón ▼ o ▲ se pasa por las siguientes configuración de la lama. Seleccione la configuración deseada.

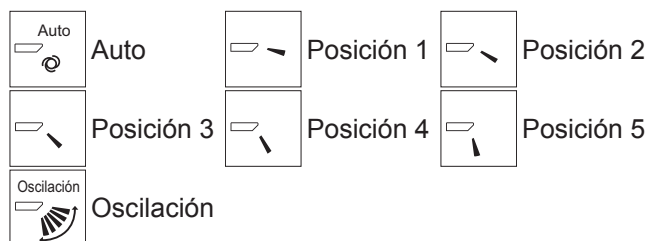

Seleccione “Oscilación” para que las lamas se muevan hacia arriba y hacia abajo automáticamente.

Cuando configure de “Posición 1” a “Posición 5”, la lama estará fija en el ángulo seleccionado.

- **1h** a la izquierda del icono de configuración de la lama. Este icono aparece cuando el deflector está configurado a Posición 2, 3, 4 o 5 y el ventilador funciona a una velocidad baja en funcionamiento en frío o seco (depende del modelo). El icono desaparecerá en una hora y la configuración de la lama cambiará automáticamente.

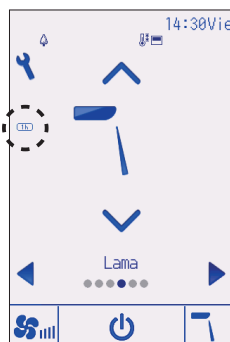

Configuración del deflector

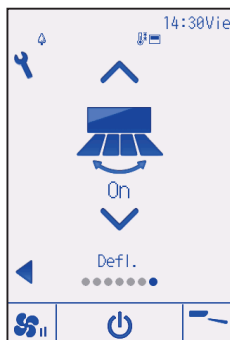

(Ejemplo de pantalla en CITY MULTI)

Presione el botón ▼ o ▲ para activar o desactivar la oscilación del deflector.



Configuración de la ventilación

La ventilación se puede configurar aun cuando las unidades estén en funcionamiento.



(Ejemplo de pantalla en Mr. SLIM)

Cada vez que se presiona el botón ▼ o ▲ se pasa por las siguientes configuraciones de ventilación.

* Solamente se puede configurar cuando la unidad Lossnay está conectada.



• En algunos modelos de unidades interiores, es posible que el ventilador se bloquee con ciertos modelos de unidades de ventilación.

Navegación por el menú

Lista del Menú principal

Menú principal	Opciones de configuración		Detalles de configuración	Página
Operación	Super		Utilizar para alcanzar rápidamente una temperatura cómoda en la habitación. <ul style="list-style-type: none"> Las unidades pueden ser utilizadas en modo Alta potencia durante un máximo de 30 minutos. 	25
	Confort	Ángulo lama manual	Utilizar para fijar el ángulo de cada lama.	26
Programador	Programador	Programador On/Off	Utilizar para establecer las horas de Encendido/Apagado. <ul style="list-style-type: none"> La hora se puede establecer en incrementos de 5 minutos. * Es necesario configurar la hora. 	29
		Programador Auto-Off	Utilizar para configurar la hora de desconexión automática. <ul style="list-style-type: none"> La hora se puede establecer en un valor de 30 a 240 en incrementos de 10 minutos. 	32
	Programador semanal		Utilizar para establecer las horas de Encendido/Apagado semanal. <ul style="list-style-type: none"> Se pueden configurar hasta ocho patrones de funcionamiento para cada día. Pueden establecerse dos tipos de calendarios semanales. * Es necesario configurar la hora. * No es válido con el Programador On/Off activado. * Incrementos de 1°C 	34
	Unidad exterior modo silencioso		Utilizar para establecer los periodos de tiempo durante los cuales se le da prioridad al funcionamiento silencioso de las unidades exteriores sobre el control de la temperatura. Configure las horas de Inicio/Parada para cada día de la semana. <ul style="list-style-type: none"> Seleccione el nivel de silencio deseado entre "Norml", "Medio" y "Silencioso". * Es necesario configurar la hora. 	37
	Modo noche		Utilizar para realizar los ajustes del modo noche. <ul style="list-style-type: none"> Seleccione "Si" para habilitar la configuración y "No" para deshabilitarla. Se pueden configurar el rango de la temperatura y las horas de inicio/parada. * Es necesario configurar la hora. * Incrementos de 1°C 	40
Ahorro energía	Restricción	Rango de temperatura	Utilizar para restringir el rango de temperatura preestablecida. <ul style="list-style-type: none"> Se pueden configurar diferentes rangos de temperaturas para diferentes modos de funcionamiento. * Incrementos de 1°C 	43
		Operación bloqueada	Utilizar para bloquear las funciones seleccionadas. <ul style="list-style-type: none"> Las funciones bloqueadas no se pueden utilizar. 	46
	Ahorro energía	Auto recuperación	Utilizar para hacer que las unidades funcionen a la temperatura preestablecida después de haber estado en modo ahorro energía durante determinado tiempo. <ul style="list-style-type: none"> La hora se puede establecer en un valor de 30 a 120 en incrementos de 10 minutos. * Esta función no será válida cuando estén restringidos los rangos de temperaturas preestablecidas. * Incrementos de 1°C 	49

Menú principal	Opciones de configuración		Detalles de configuración	Página
Ahorro energía	Ahorro energía	Calendario	<p>Configurar los tiempos de arranque/parada para que las unidades funcionen en modo ahorro energía para cada uno de los días de la semana, y establecer el grado de ahorro.</p> <ul style="list-style-type: none"> • Se pueden establecer hasta cuatro modelos de funcionamiento de ahorro energía para cada día. • La hora se puede establecer en incrementos de 5 minutos. • El grado de ahorro energía se puede establecer en un valor desde 0% y 50 hasta 90% en incrementos del 10%. <p>* Es necesario configurar la hora.</p>	51
Configuración inicial	Configuración básica	Hora	Utilizar para configurar la hora actual.	54
		Horario de verano	Ajusta el horario de verano.	56
	Configuración de pantalla	Pantalla principal	Utilizar para cambiar entre los modos de visualización de pantalla “Completo” o “Básico” para la pantalla de estado y la pantalla principal.	58
		Brillo	Utilizar para ajustar el brillo de la pantalla.	61
		Seleccione el idioma	Utilizar para seleccionar el idioma deseado.	62
		Diseño	Utilizar para cambiar el color de la pantalla de estado y de la pantalla principal.	64
	Pantalla táctil	Calibración de la pantalla táctil	Establece la configuración de calibración para la pantalla táctil.	66
		Limpieza de la pantalla táctil	Desactiva temporalmente la sensibilidad táctil de la pantalla para poder limpiarla.	68
Revisión	Inicializar controlador remoto	Utilizar para inicializar el controlador remoto al estado predeterminado de fábrica.	70	
	Información de controlador remoto	Utilizar para visualizar el nombre del modelo del controlador remoto, la versión del software y el número de serie.	72	
Mantenimiento	Información de errores	<p>Utilizar para comprobar la información del error cuando sucede un error.</p> <ul style="list-style-type: none"> • Se pueden visualizar el código de error, el origen del error, la dirección del refrigerante, el modelo de la unidad, el número de fabricación y la información de contacto (número de teléfono del distribuidor). <p>* El modelo de la unidad, el número de fabricación y la información de contacto deben registrarse previamente para que se puedan mostrar.</p>	74	
	Información de filtros	<p>Utilizar para comprobar el estado del filtro.</p> <ul style="list-style-type: none"> • Se puede restaurar la señal del filtro. 	78	

Navegación por el menú

Navegación por el menú principal

Funcionamiento del botón

Acceso al menú principal



Presione el botón **Ajuste** de la pantalla principal.

Aparecerá el Menú principal.

Selección del elemento



Presione **F2** para mover el cursor hacia la izquierda.

Presione **F3** para mover el cursor hacia la derecha.

Opciones de configuración de las funciones

Super



Descripción del funcionamiento

La función de funcionamiento en alta potencia permite que la unidad funcione con una capacidad superior a la normal de modo que el aire de la habitación pueda ser acomodado a la temperatura óptima con rapidez. Este funcionamiento durará hasta 30 minutos y la unidad volverá automáticamente al modo de funcionamiento normal transcurridos los 30 minutos o cuando la temperatura de la habitación haya alcanzado la temperatura preestablecida, lo que suceda antes. La unidad volverá al modo de funcionamiento normal cuando se cambie el modo de funcionamiento o la velocidad del ventilador.

Funcionamiento del botón

1



Seleccione "Super" en el menú de operación en funcionamiento en modo Frío, Calor o Auto y presione el botón **ACEPTAR**.

La función "Super" solamente está disponible en los modelos que la admiten.

2

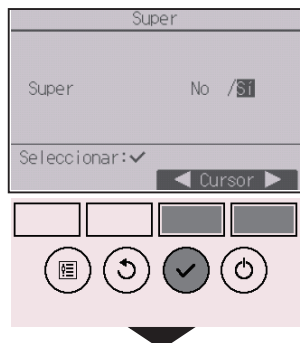

Mueva el cursor a "SI" con los botones **F3** o **F4**, y presione el botón **ACEPTAR**.

Aparecerá una ventana de confirmación.

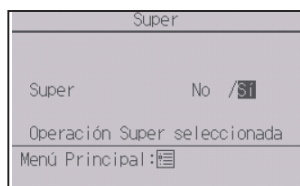

Navegación por las pantallas

- Para volver al Menú principal Botón **MENU**
- Para volver a la pantalla anterior Botón **VOLVER**

Opciones de configuración de las funciones

Funcionamiento del botón

1

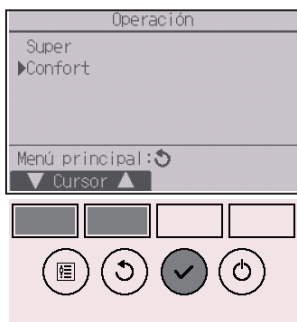

Seleccione “Confort” en el menú Operación y presione el botón **ACEPTAR**.

2



Seleccione “Ángulo lama manual” con el botón **F1** o **F2** y presione el botón **ACEPTAR**.

3



Mueva el cursor a “Codific.Ref.” o “Nº Unid.” con el botón **[F1]** para seleccionar dicha opción. Seleccione la dirección del refrigerante y el número de unidad para las unidades cuyas lamas deba fijar, con el botón **[F2]** o **[F3]**, y presione el botón **ACEPTAR**.

- Codificación: Dirección refrigerante
- Número de unidad: 1, 2, 3, 4

Presione el botón **[F4]** para confirmar la unidad.

La pantalla de la izquierda muestra un ejemplo de pantalla en las unidades Mr. SLIM. En las unidades CITY MULTI, se muestra “Direcc. M-NET” en lugar de “Codific.Ref.” y no se muestra “Nº Unid.”.

4

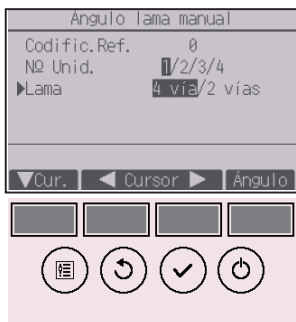

Seleccione “Lama” con el botón **[F1]**.

Seleccione “4 vías” o “2 vías” con el botón **[F2]** o **[F3]** y presione el botón **[F4]**.

Opciones de configuración de las funciones

5

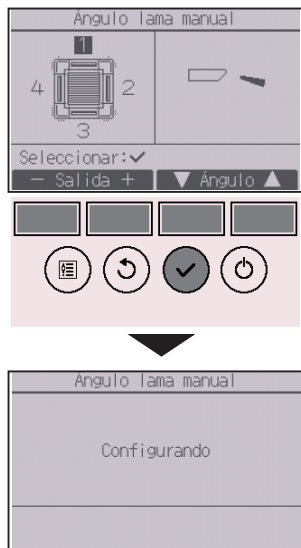

Aparecerán los ajustes actuales.

Seleccione las salidas que desee entre “1”, “2”, “3”, “4” o “1, 2, 3, 4 (todas las salidas)” con el botón [F1] o [F2].

Presione el botón [F3] o [F4] para pasar por las siguientes opciones y seleccionar la configuración deseada.

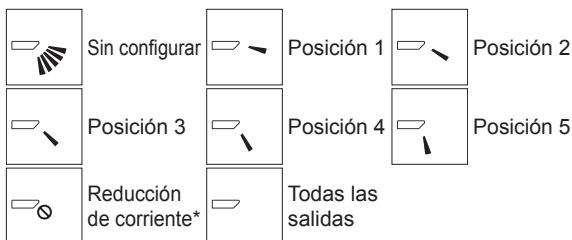

Presione el botón [ACEPTAR] para guardar los ajustes.

Aparecerá una pantalla indicando que se está transmitiendo la información de configuración.

Los cambios de configuración se realizarán en la salida seleccionada.

La pantalla volverá automáticamente a la pantalla anterior cuando finalice la transmisión.

Realice las configuraciones para las otras salidas, siguiendo los mismos procedimientos.

Si se seleccionan todas las salidas, se mostrará  la próxima vez que la unidad entre en funcionamiento.

Navegación por las pantallas

- Para volver a la pantalla anterior Botón [VOLVER]

*Reducción de corriente

El modo [Reducción de corriente] mantiene el ángulo de veleta más horizontal que el ángulo de la Posición 1 de manera que el flujo de aire no se dirija hacia las personas. Esta función solo se puede establecer para una salida.

Esta función no se puede establecer para modelos con dos o tres salidas.

En el modo Reducción de corriente, el flujo de aire puede provocar la decoloración del techo.

Programador (Programador On/Off)



Funcionamiento del botón

1



Seleccione “Programador” en el Menú principal (consulte la página 24) y presione el botón **ACEPTAR**.

El Programador On/Off no funcionará en los siguientes casos:

cuando el programador On/Off está deshabilitado, durante un error, durante una comprobación (en el menú de revisión), durante la ejecución de una prueba, durante el diagnóstico del controlador remoto, cuando el reloj no está configurado, durante la configuración de función, cuando el sistema está controlado de forma centralizada (la operación “On/Off” o la operación de programador desde el controlador remoto local están prohibidas).

2

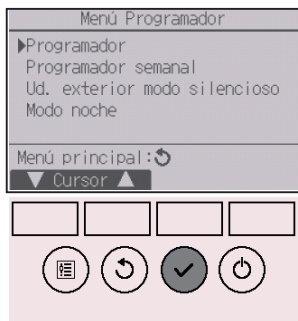

Mueva el cursor a “Programador” y presione el botón **ACEPTAR**.

3

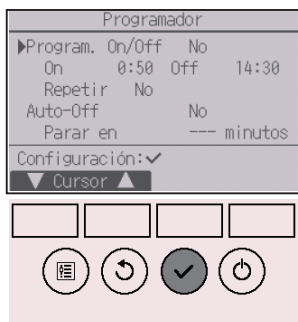

Aparecerán los ajustes actuales.

Mueva el cursor a “Program. On/Off” y presione el botón **ACEPTAR**.

Opciones de configuración de las funciones

4



Aparecerá la pantalla para configurar el temporizador.

Seleccione el elemento que desee con el botón **F1** o **F2** entre “Program. On/Off”, “On”, “Off” o “Repetir”.

5

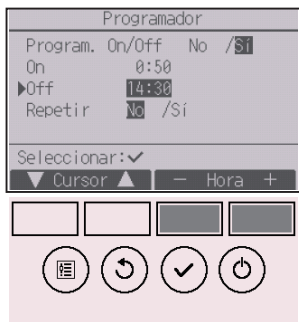

Cambie la configuración con el botón **F3** o **F4**.

- Program. On/Off: No (deshabilitar)/Sí (habilitar)
- On: Hora de inicio de la operación (se puede ajustar en incrementos de 5 minutos)
 - * Mantenga presionado el botón para avanzar rápido por los números.
- Off: Hora de parada de la operación (se puede ajustar en incrementos de 5 minutos)
 - * Mantenga presionado el botón para avanzar rápido por los números.
- Repetir: No (una vez)/Sí (repetir)

6



Presione el botón **ACEPTAR** para guardar los ajustes.

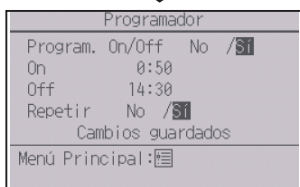



Aparecerá una ventana de confirmación.

Navegación por las pantallas

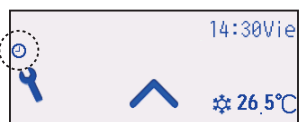
- Para volver al Menú principal Botón **MENÚ**
- Para volver a la pantalla anterior Botón **VOLVER**



 aparecerá en la pantalla de estado y en la pantalla principal en el modo Completo cuando el programador On/Off esté activado.

 aparece al deshabilitar el programador mediante el sistema de control centralizado.

Opciones de configuración de las funciones

Programador (Programador Auto-Off)



Funcionamiento del botón

1



Ver la pantalla de configuración del Programador.
(Consulte la página 29.)

Seleccione “Auto-Off” y presione el botón **ACEPTAR**.

El Programador Auto-Off no funcionará en los siguientes casos:

cuando el programador Auto-Off está deshabilitado, durante un error, durante una comprobación (en el menú de revisión), durante la ejecución de una prueba, durante el diagnóstico del controlador remoto, durante la configuración de función, cuando el sistema está controlado de forma centralizada (la operación “On/Off” o la operación de programador desde el control local están prohibidas).

2

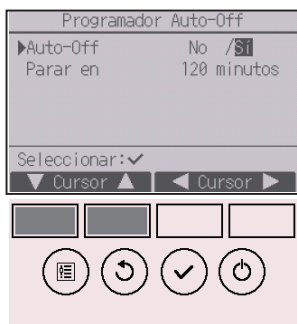

Aparecerán los ajustes actuales.

Mueva el cursor a “Auto-Off” o “Parar en --- minutos” con el botón **F1** o **F2**.

3



Cambie la configuración con el botón **F3** o **F4**.

- Auto-Off: No (deshabilitar)/Sí (habilitar)
- Parar en --- minutos: Configuración del programador (el rango se puede establecer entre 30 y 240 en incrementos de 10 minutos).

4

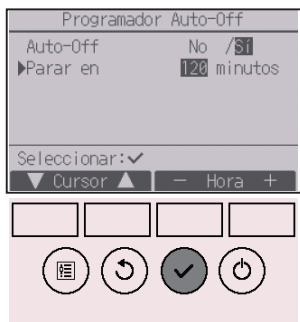

Presione el botón **ACEPTAR** para guardar los ajustes.

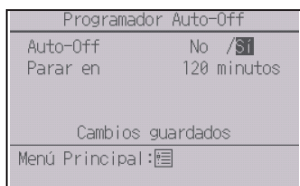



Aparecerá una ventana de confirmación.

Navegación por las pantallas

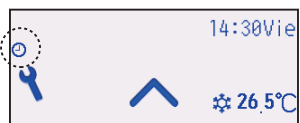
- Para volver al Menú principal Botón **MENÚ**
- Para volver a la pantalla anterior Botón **VOLVER**



 aparecerá en la pantalla de estado y en la pantalla principal en el modo Completo cuando el programador Auto-Off esté activado.

 aparece al deshabilitar el programador mediante el sistema de control centralizado.

Opciones de configuración de las funciones

Programador semanal



Funcionamiento del botón

1



Seleccione “Programador semanal” en el menú Programador y presione el botón **ACEPTAR**.

El Programador semanal no funcionará en los siguientes casos:

cuando el Programador On/Off está activado, cuando el Programador semanal está deshabilitado, durante un error, durante una comprobación (en el menú de revisión), durante la ejecución de una prueba, durante el diagnóstico del controlador remoto, cuando el reloj no está configurado, durante la configuración de función y cuando el sistema está controlado a nivel central (la operación “On/Off”, el ajuste de temperatura o la operación de programador desde el controlador remoto local están prohibidos).

2



Aparecerán los ajustes actuales.

Presione el botón **F1** o **F2** para ver la configuración para cada día de la semana.

Presione el botón **F3** para ver los patrones 5 a 8.

Presione el botón **F4** para ver el estado de la configuración 2.

Presione el botón **ACEPTAR** para ir a la pantalla de configuración.

3



Aparecerá la pantalla de configuración del programador semanal.

En la opción “Acción”, seleccione “1” para habilitar la opción de programador 1, o seleccione “2” para activar la opción de programador 2 con el botón **F3** o **F4**. A continuación, presione el botón **ACEPTAR**.

Para comprobar el contenido de la configuración de la opción 1 o 2, mueva el cursor a “Configurando” con el botón **F1** o **F2** y seleccione “1” o “2” con el botón **F3** o **F4**.

4



Aparecerá la pantalla del programador semanal y se mostrarán los ajustes actuales.

Se pueden configurar hasta ocho patrones de funcionamiento para cada día.

Mueva el cursor al día deseado de la semana con el botón **F1** o **F2**, y presione el botón **F3** para seleccionarlo. (Se pueden seleccionar varios días).

Presione el botón **ACEPTAR**.

Opciones de configuración de las funciones

5

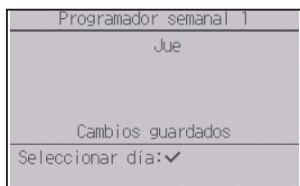

Aparecerá una pantalla de configuración del patrón de funcionamiento.

Presione el botón **[F1]** para mover el cursor al número de patrón seleccionado.

Mueva el cursor hasta la hora, On/Off o hasta la temperatura con el botón **[F2]**.

Cambie la configuración con el botón **[F3]** o **[F4]**.

- Hora: configurable en incrementos de 5 minutos
* Mantenga presionado el botón para avanzar rápido por los números.
- On/Off/Auto: Los ajustes seleccionables dependen del modelo de la unidad interior conectada. (Al ejecutar un patrón "Auto", el sistema operará en el modo "Auto" (punto de ajuste doble).)
- Temperatura: El rango de temperaturas que se puede configurar varía en función de las unidades interiores conectadas. (Incrementos de 1°C)
Cuando el modo "Auto" (punto de ajuste doble) es seleccionado, se pueden ajustar dos temperaturas preestablecidas. Si un patrón de operación con un ajuste simple de temperatura preestablecida es ejecutado durante el modo "Auto" (punto de ajuste doble), su ajuste será utilizado como el ajuste de temperatura de enfriamiento en el modo "Frío".

Presione el botón **[ACEPTAR]** para guardar los ajustes.

Aparecerá una ventana de confirmación.

Navegación por las pantallas

- Para regresar a la pantalla de selección del cambio de configuración/día de la semana Botón **[ACEPTAR]**
- Para volver al Menú principal Botón **[MENÚ]**
- Para volver a la pantalla anterior Botón **[VOLVER]**



[7] aparecerá en la pantalla de estado y en la pantalla principal en modo Completo cuando exista la configuración del programador semanal para el día actual.

El icono no aparecerá mientras el programador "On/Off" esté activado o el sistema sea controlado de forma centralizada (la operación "Programador" desde el controlador remoto local está prohibida).

Descripción del funcionamiento

Utilizar para establecer los periodos de tiempo durante los cuales se le da prioridad al funcionamiento silencioso de las unidades exteriores sobre el control de la temperatura. Configure las horas de inicio y parada de la función de silencio de cada uno de los días de la semana. Seleccione el nivel de silencio deseado entre “Medio” y “Silencioso”.

Funcionamiento del botón

1

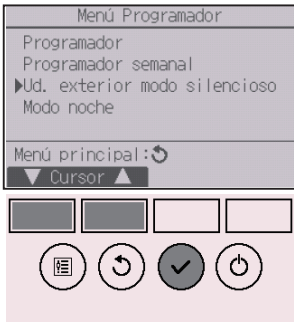

Seleccione “Ud. exterior modo silencioso” en el menú Programador y presione el botón **ACEPTAR**.

La función “Ud. exterior modo silencioso” solamente está disponible en los modelos que la admiten.

2



Aparecerán los ajustes actuales.

Presione el botón **F1** o **F2** para ver la configuración para cada día de la semana.

Presione el botón **ACEPTAR** para ir a la pantalla de configuración.

Opciones de configuración de las funciones

3



Aparecerá la pantalla para activar (Sí) y desactivar (No) el modo silencioso.

Para activar esta configuración, mueva el cursor a "Sí" con el botón **[F3]** o **[F4]** y presione el botón **[ACEPTAR]**.

4

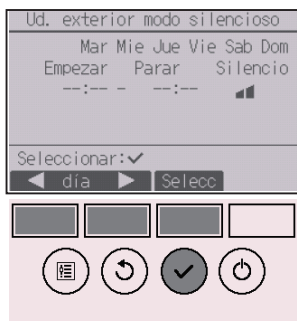

Aparecerá la pantalla de modo silencioso de la unidad exterior.

Para realizar o cambiar la configuración, mueva el cursor al día deseado de la semana con el botón **[F1]** o **[F2]**, y presione el botón **[F3]** para seleccionarlo. (Se pueden seleccionar varios días).

Presione el botón **[ACEPTAR]**.

5

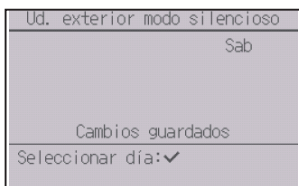

Aparecerán los ajustes actuales.

Mueva el cursor al elemento deseado de Hora de inicio, Hora de parada o Nivel de silencio con el botón **[F1]** o **[F2]**.

Cambie la configuración con el botón **[F3]** o **[F4]**.

- Hora de inicio/parada: configurable en incrementos de 5 minutos
 - * Mantenga presionado el botón para avanzar rápido por los números.
- Nivel de silencio: Normal, Medio, Silencioso



Normal



Medio



Silencioso

Presione el botón **[ACEPTAR]** para guardar los ajustes. Aparecerá una ventana de confirmación.

Navegación por las pantallas

- Para regresar a la pantalla de selección del cambio de configuración/día de la semana Botón **[ACEPTAR]**
- Para volver al Menú principal Botón **[MENÚ]**
- Para volver a la pantalla anterior Botón **[VOLVER]**



aparecerá en la pantalla de estado y en la pantalla principal en el modo Completo en el modo silencioso de la unidad exterior.

Opciones de configuración de las funciones

Modo noche



Descripción del funcionamiento

Este control inicia el funcionamiento de la calefacción cuando se detiene el grupo del objeto de control y la temperatura de la habitación cae por debajo del límite inferior de temperatura. Además, este control inicia el funcionamiento de la calefacción cuando se detiene el grupo del objeto de control y la temperatura de la habitación sube por encima del límite superior de temperatura.

La función de modo noche no está disponible si la configuración del funcionamiento y la temperatura se realizan desde el controlador remoto.

Si el sensor de temperatura de succión del aire acondicionado mide la temperatura, no se podrá conseguir una medición precisa cuando el aire acondicionado no esté activo o cuando el aire no esté limpio. En este caso, cambie el sensor a un sensor remoto (PAC-SE40TSA/PAC-SE41TS-E) o a un sensor de controlador remoto.

Funcionamiento del botón

1

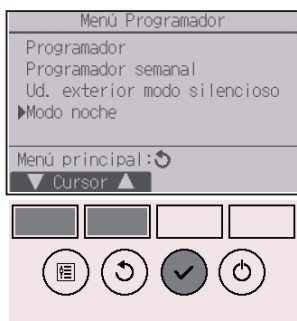

Seleccione "Modo noche" en el menú Programador y presione el botón **ACEPTAR**.

2



Aparecerán los ajustes actuales.

Presione el botón **ACEPTAR** para ir a la pantalla de configuración.

3

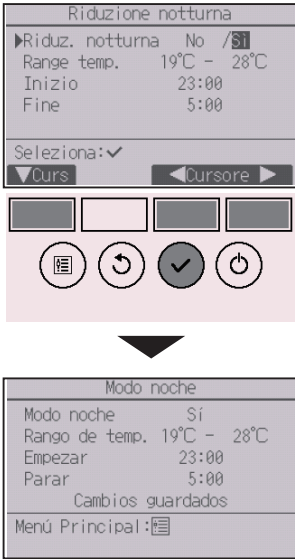

Mueva el cursor al elemento deseado con el botón **F1** o **F2** en Modo noche No (deshabilitar)/Sí (habilitar), rango de temperaturas, hora de inicio u hora de parada.

Cambie la configuración con el botón **F3** o **F4**.

- Rango de temp.: se puede configurar el límite inferior de temperatura (para el funcionamiento de la calefacción) y el límite superior de temperatura (para el funcionamiento de la refrigeración). La diferencia de temperatura entre los límites superior e inferior debe ser de 4°C (8°F) o más. El rango de temperatura que se puede configurar varía dependiendo del modelo de unidad interior.

* Incrementos de 1°C

- Hora de inicio/parada: configurable en incrementos de 5 minutos

* Mantenga presionado el botón para avanzar rápido por los números.

Presione el botón **ACEPTAR** para guardar los ajustes.

Aparecerá una ventana de confirmación.

Navegación por las pantallas

- Para volver al Menú principal Botón **MENÚ**
- Para volver a la pantalla anterior Botón **VOLVER**

Opciones de configuración de las funciones



 aparecerá en la pantalla de estado y en la pantalla principal en el modo Completo cuando la función Modo noche esté activada.

 aparece al deshabilitar el programador mediante el sistema de control centralizado.

El Modo noche no funcionará en los siguientes casos:

cuando la unidad esté en funcionamiento, cuando a función Modo noche esté deshabilitada, durante un error, durante una comprobación (en el menú de revisión), durante la ejecución de una prueba, durante el diagnóstico del controlador remoto, cuando el reloj no está configurado, durante la configuración de función y cuando el sistema está controlado a nivel central (la operación "On/Off", el ajuste de temperatura o la operación de programador desde el controlador remoto local están prohibidos).

Configurar la restricción del rango de temperatura

Funcionamiento del botón

1



Seleccione “Ahorro energía” en el Menú principal (consulte la página 24) y presione el botón **ACEPTAR**.

2

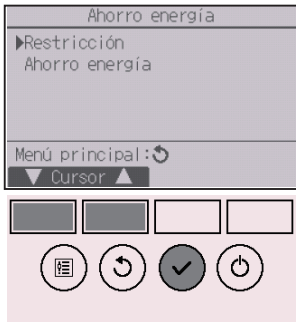

Mueva el cursor a “Restricción” con el botón **F1** o **F2**, y presione el botón **ACEPTAR**.

Opciones de configuración de las funciones

3



Aparecerán los ajustes actuales.

Mueva el cursor a “Rango de temp.” con el botón **[F1]** o **[F2]**, y presione el botón **[ACEPTAR]**.

4



Aparecerá la pantalla para configurar el rango de temperatura.

Mueva el cursor al elemento deseado con el botón **[F1]** de “Rango temp.”, “Frio·Secar”, “Calor” o “Auto”.

5

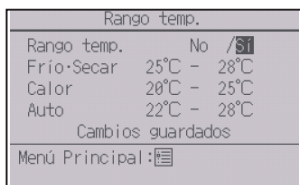

Cambie la configuración con el botón **[F3]** o **[F4]**.

- Rango de temp.: No (no restringido) o Sí (restringido)
- Frío·Secar: Limite superior e inferior de temperatura (Incrementos de 1°C)
- Calor: Limite superior e inferior de temperatura (Incrementos de 1°C)
- Auto: Limite superior e inferior de temperatura (Incrementos de 1°C)

Rangos de configuración de la temperatura

Modo		Límite inferior	Límite superior
Frío·Secar	*1 *3	19 ~ 30°C (67 ~ 87°F)	30 ~ 19°C (87 ~ 67°F)
Calor	*2 *3	17 ~ 28°C (63 ~ 83°F)	28 ~ 17°C (83 ~ 63°F)
Auto	*4	19 ~ 28°C (67 ~ 83°F)	28 ~ 19°C (83 ~ 67°F)

* El rango configurable dependerá de la unidad conectada.

*1 Los rangos de temperaturas para los modos Frío, Secar y Auto (punto de ajuste doble) pueden ajustarse.

*2 Los rangos de temperaturas para los modos Calor y Auto (punto de ajuste doble) pueden ajustarse.

*3 Los rangos de temperatura para los modos Calor, Frío y Secar deben cumplir las siguientes condiciones:

- Limite superior de enfriamiento - límite superior de calentamiento \geq diferencia de temperatura mínima (varía en función del modelo de unidad interior)
- Limite inferior de enfriamiento - límite inferior de calentamiento \geq diferencia de temperatura mínima (varía en función del modelo de la unidad interior)

*4 El rango de temperatura del modo Auto (punto de ajuste simple) puede ajustarse.

Presione el botón **[ACEPTAR]** para guardar los ajustes.

Aparecerá una ventana de confirmación.

Navegación por las pantallas

- Para volver al Menú principal Botón **[MENÚ]**
- Para volver a la pantalla anterior Botón **[VOLVER]**



 aparecerá en la pantalla de estado y en la pantalla principal en el modo Completo cuando el rango de temperaturas esté restringido.

Opciones de configuración de las funciones

Restricción



Función de bloqueo de operación

Para habilitar la función de bloqueo, configure el elemento “Op. Bloqueada” a “Sí”.

Funcionamiento del botón

1



Ver la pantalla de configuración de Restricción. (Consulte la página 43.)

Mueva el cursor a “Op. Bloqueada” y presione el botón **ACEPTAR**.

2

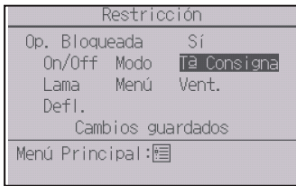

Aparecerá la pantalla para realizar la configuración de la función de bloqueo.

Mueva el cursor al elemento deseado con el botón **[F1]** o **[F2]** en “Op. Bloqueada”, “Ubicación”, “On/Off”, “Modo”, “Tª Consigna”, “Menú”, “Vent.”, “Defl.” o “Lama”.

Cambie la configuración con el botón **[F3]** o **[F4]**.

- Op. Bloqueada: No (deshabilitar)/Sí (habilitar)
- Ubicación: “Indiv.” u “Hotel”
- On/Off: Funcionamiento de Encendido/Apagado
- Modo: Configuración del modo de funcionamiento
- Tª Consigna: Configuración temperatura preestablecida
- Lama: Configuración de la lama
- Menú: Configuración de menú
- Vent.: Configuración de la velocidad del ventilador
- Deflector: Configuración del deflector

“-” / “Bloqueado”

Si se selecciona “Hotel” para la opción “Ubicación”, las siguientes funciones se bloquearán automáticamente: Modo, Lama, Menú y Deflector.

Presione el botón **[ACEPTAR]** para guardar los ajustes.

Aparecerá una ventana de confirmación.

Navegación por las pantallas

- Para volver al Menú principal Botón **[MENÚ]**
- Para volver a la pantalla anterior Botón **[VOLVER]**

Opciones de configuración de las funciones



 aparecerá en la pantalla de estado y en la pantalla principal en el modo Completo cuando la función de bloqueo de funcionamiento esté activada.

Se suprimirá la guía de funcionamiento correspondiente a la función bloqueada.

Para mostrar el menú principal cuando la configuración de menú está bloqueada, mantenga presionado el botón **Ajuste** durante diez segundos como mínimo. Introduzca la contraseña del administrador en la pantalla de introducción de la contraseña.

Retorno automático a la temperatura preestablecida

Después de que se active la función de Auto recuperación, cuando se realiza el cambio de modo de funcionamiento o la operación ON/OFF (encendido/apagado) con este controlador remoto, la temperatura establecida vuelve automáticamente a la temperatura solicitada independientemente del tiempo establecido.

Funcionamiento del botón

- 1 Seleccione "Ahorro energía" en el menú Ahorro energía y presione el botón **ACEPTAR**.

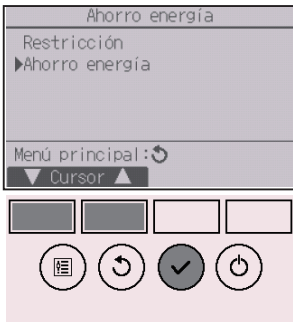

- 2 Aparecerán los ajustes actuales. Mueva el cursor a "Auto recuperac." con el botón **F1** o **F2**, y presione el botón **ACEPTAR**.



Opciones de configuración de las funciones

3



Aparecerá la pantalla para configurar el retorno automático a la temperatura preestablecida.

Mueva el cursor al elemento deseado con el botón **[F1]** o **[F2]** en “Auto recuperac.”, “Frío” o “Calor”.

4



Cambie la configuración con el botón **[F3]** o **[F4]**.

- Auto recuperac.: No (deshabilitar)/Sí (habilitar)
- Frío: el rango de valores del programador es de 30 a 120 minutos en incrementos de 10 minutos. El rango de configuración de temperatura es de 19 a 30°C (de 67 a 87°F) (en incrementos de 1°C).
- Calor: el rango de valores del programador es de 30 a 120 minutos en incrementos de 10 minutos. El rango de configuración de temperatura es de 17 a 28°C (de 63 a 83°F) (en incrementos de 1°C).

Presione el botón **ACEPTAR** para guardar los ajustes. “Frío” incluye los modos “Secar” y “Auto Frío”, y “Calor” incluye el modo de “Auto Calor”. Aparecerá la pantalla para configurar el elemento seleccionado.

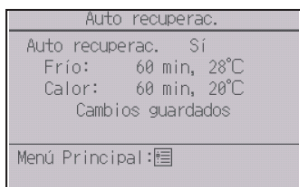

Navegación por las pantallas

- Para volver al Menú principal Botón **[MENU]**
- Para volver a la pantalla anterior Botón **[VOLVER]**

Los ajustes de programador o temperatura preestablecida no serán efectivos cuando el rango de temperaturas esté restringido y cuando el sistema esté controlado de forma centralizada (cuando el ajuste del rango de temperaturas desde el control local esté prohibido). Cuando el sistema es controlado de forma centralizada (cuando la operación “Programador” desde el controlador remoto local esté prohibida), únicamente el ajuste del “Programador” será inefectivo.

Configuración de la programación del funcionamiento de ahorro energía

Funcionamiento del botón

1



Ver la pantalla “Ahorro energía”. (Consulte la página 49.)

Mueva el cursor a “Calendario” y presione el botón **ACEPTAR**.

2



Aparecerá la pantalla para configurar la programación.

Presione el botón **F1** o **F2** para ver la configuración para cada día de la semana.

Presione el botón **ACEPTAR** para ir a la pantalla de configuración.

3

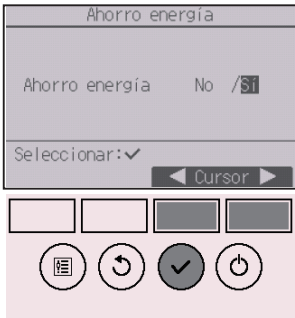

Aparecerá la pantalla para activar (Sí) y desactivar (No) la programación del modo ahorro energía.

Seleccione “No” o “Sí” con el botón **F3** o **F4**.

Presione el botón **ACEPTAR** para ir a la pantalla de selección de cambio de configuración/día de la semana.

Opciones de configuración de las funciones

4



Aparecerá la pantalla de selección de cambio de configuración/día de la semana.

Se pueden configurar hasta cuatro patrones de funcionamiento para cada día.

Mueva el cursor al día deseado de la semana con el botón [F1] o [F2], y presione el botón [F3] para seleccionarlo. (Se pueden seleccionar varios días). Presione el botón **ACEPTAR** para ir a la pantalla de configuración del patrón.

5



Aparecerá una pantalla de configuración del patrón.

Presione el botón [F1] para mover el cursor al número de patrón seleccionado.

Mueva el cursor al elemento deseado con el botón [F2] tiempo de inicio, tiempo de parada e índice de ahorro energía (en este orden desde la izquierda).

Cambie la configuración con el botón [F3] o [F4].

- Hora de inicio/parada: configurable en incrementos de 5 minutos
- * Mantenga presionado el botón para avanzar rápido por los números.
- Índice de ahorro energía: El rango de valores de configuración es de 0% y 50 a 90% en incrementos del 10%.

Presione el botón **ACEPTAR** para guardar los ajustes.

Aparecerá una ventana de confirmación.

Cuanto más bajo sea el valor, mayor será el efecto de ahorro energético.



 aparecerá en la pantalla de estado y en la pantalla principal en modo Completo cuando la unidad esté funcionando en modo ahorro energía.

Navegación por las pantallas

- Para regresar a la pantalla de selección del cambio de configuración/día de la semana Botón **ACEPTAR**
- Para volver al Menú principal Botón **MENU**
- Para volver a la pantalla anterior Botón **VOLVER**

Opciones de configuración de las funciones

Hora



Funcionamiento del botón

1



Seleccione “Configuración Inicial” en el Menú principal (consulte la página 24) y presione el botón **ACEPTAR**.

Es necesario configurar el reloj antes de realizar las siguientes configuraciones.

- Programador On/Off
- Programador semanal
- Unidad exterior modo silencioso
- Ahorro energía
- Modo noche

Si un sistema determinado no tiene controladores de sistema, la hora no se corregirá automáticamente. En tal caso, corrija la hora periódicamente.

2

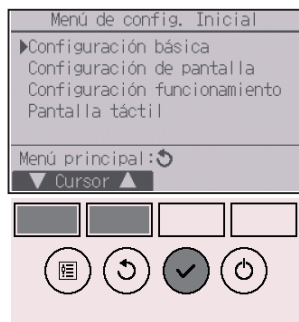

Mueva el cursor a “Configuración básica” con el botón **F1** o **F2**, y presione el botón **ACEPTAR**.

3

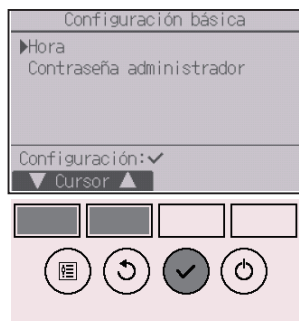

Seleccione “Hora” con el botón **F1** o **F2**, y presione el botón **ACEPTAR**.

4

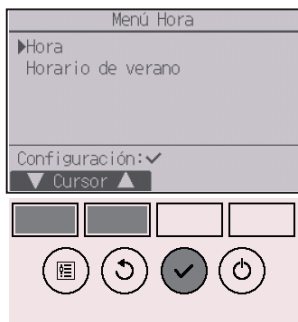

Mueva el cursor a "Hora" con el botón **[F1]** o **[F2]**, y presione el botón **[ACEPTAR]**.

5

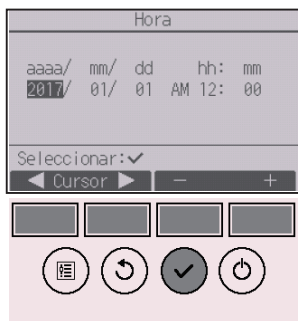

Mueva el cursor al elemento deseado con los botones **[F1]** o **[F2]** para año, mes, fecha, hora o minuto.

Aumente o disminuya el valor para el elemento seleccionado con el botón **[F3]** o **[F4]** y presione el botón **[ACEPTAR]**.

Aparecerá una ventana de confirmación.

Navegación por las pantallas

- Para volver al Menú principal Botón **[MENÚ]**
- Para volver a la pantalla anterior Botón **[VOLVER]**

Opciones de configuración de las funciones

Horario de verano



Descripción del funcionamiento

Es posible ajustar la hora de inicio/fin del horario de verano. La función de horario de verano se activará en función de la configuración.

- Si un determinado sistema tiene un controlador de sistema, desactive este ajuste para conservar la hora correcta.
- Al principio y al final del horario de verano, el programador puede ponerse en acción dos veces o ninguna.
- Esta función no funcionará si no se ha ajustado la hora.

Funcionamiento del botón

1



Seleccione “Hora” en el menú de configuración básica y presione el botón **ACEPTAR**.

2

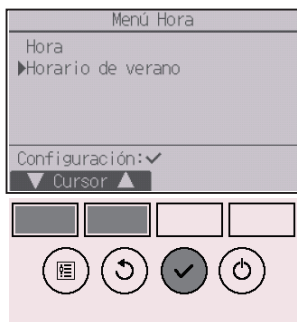

Mueva el cursor a “Horario de verano” con el botón **F1** o **F2**, y presione el botón **ACEPTAR**.

3

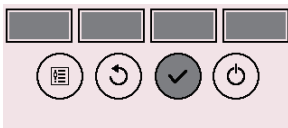
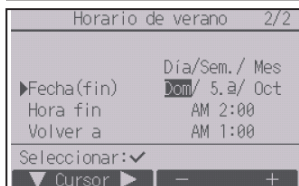
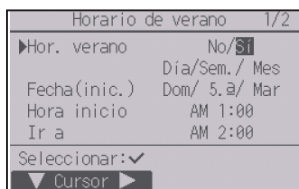

Mueva el cursor a los siguientes elementos con el botón **[F1]** para configurarlos.

- **Hor. verano**
 Seleccione "No" (desactivar) o "Sí" (activar) con el botón **[F2]**. El ajuste predeterminado es "No".
 - **Fecha(inic.)*1**
 Configure el día de la semana, el número de semana y el mes con el botón **[F3]** o **[F4]**. El ajuste predeterminado es "Dom/5.ª/Mar".
 - **Hora inicio**
 Ajuste la hora de inicio del horario de verano con el botón **[F3]** o **[F4]**.
 - **Ir a**
 Ajuste la hora a la que se tiene que adelantar el reloj a la hora de inicio de arriba con el botón **[F3]** o **[F4]**.
 - **Fecha(fin)*1 (segunda página)**
 Configure el día de la semana, el número de semana y el mes con el botón **[F3]** o **[F4]**. El ajuste predeterminado es "Dom/5.ª/Oct".
 - **Hora fin (segunda página)**
 Ajuste la hora de fin del horario de verano con el botón **[F3]** o **[F4]**.
 - **Volver a (segunda página)**
 Ajuste la hora a la que se tiene que retrasar el reloj a la hora de fin de arriba con el botón **[F3]** o **[F4]**.
- *1 Si se selecciona "5.ª" como número de semana y la 5.ª semana no existe en el mes seleccionado del año, se considerará que el ajuste es "4.ª".

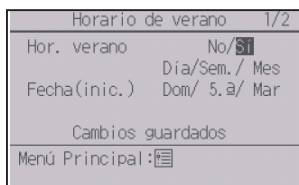

Presione el botón **[ACEPTAR]** para guardar los ajustes. Aparecerá una ventana de confirmación.

Navegación por las pantallas

- Para volver al Menú principal Botón **[MENÚ]**
- Para volver a la pantalla anterior Botón **[VOLVER]**

Opciones de configuración de las funciones

Pantalla principal



Funcionamiento del botón

1

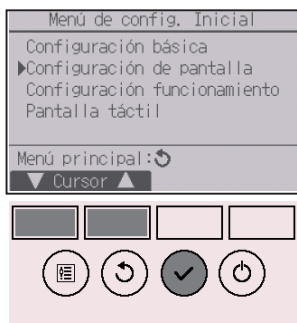

Seleccione “Configuración de pantalla” en el menú de configuración inicial y presione el botón **ACEPTAR**.

2

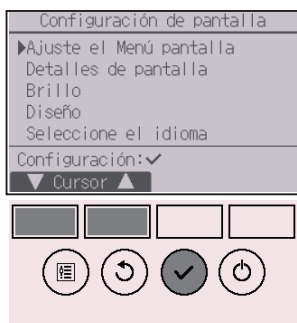

Mueva el cursor a “Ajuste el Menú pantalla” con el botón **F1** o **F2**, y presione el botón **ACEPTAR**.

3



Seleccione “Completo” o “Básico” (consulte la página 10) con el botón **F3** o **F4**, y presione el botón **ACEPTAR**.

Aparecerá una ventana de confirmación.

Navegación por las pantallas

- Para volver al Menú principal Botón **MENU**
- Para volver a la pantalla anterior Botón **VOLVER**

Funcionamiento del botón

1

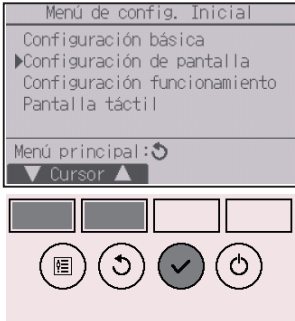

Seleccione “Configuración de pantalla” en el menú de configuración inicial y presione el botón **ACEPTAR**.

2

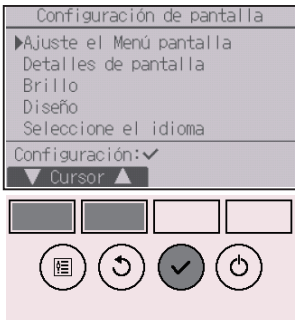

Mueva el cursor a “Ajuste el Menú pantalla” con el botón **F1** o **F2**, y presione el botón **ACEPTAR**.

3

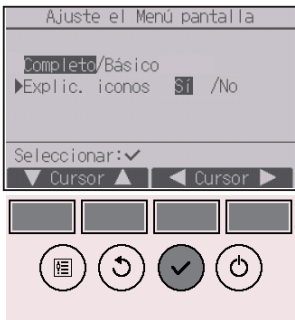

Seleccione “Explic. iconos” con el botón **F1** o **F2**, seleccione la opción “Si” o “No” con el botón **F3** o **F4**, y presione el botón **ACEPTAR**.
El ajuste predeterminado es “Si”.

Navegación por las pantallas

- Para volver al Menú principal Botón **MENU**
- Para volver a la pantalla anterior Botón **VOLVER**

Opciones de configuración de las funciones

4

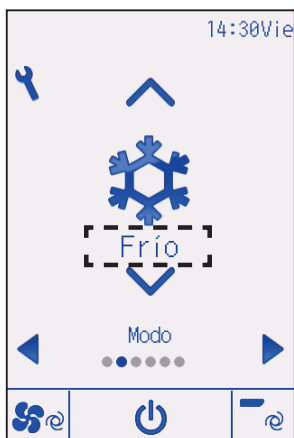

Cuando se selecciona “Sí”, la explicación del icono del elemento de configuración aparecerá como se muestra a la izquierda.

Funcionamiento del botón

1

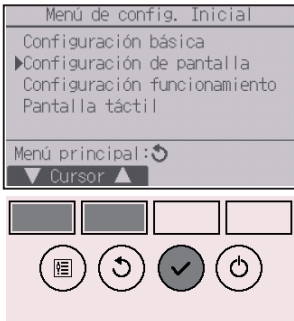

Seleccione “Configuración de pantalla” en el menú de configuración inicial y presione el botón **ACEPTAR**.

2

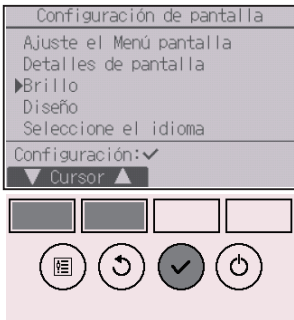

Mueva el cursor a “Brillo” con el botón **F1** o **F2**, y presione el botón **ACEPTAR**.

3



Ajuste el brillo con el botón **F1** o **F2**.

Puede seleccionar “ON” u “OFF” para la opción “Enc. perm.” con el botón **F4**.

Al seleccionar “ON”, la retroiluminación permanecerá encendida de forma atenuada incluso una vez transcurrido el tiempo especificado.

Navegación por las pantallas

- Para volver al Menú principal Botón **MENÚ**
- Para volver a la pantalla anterior Botón **VOLVER**

Opciones de configuración de las funciones

Seleccione el idioma



Descripción del funcionamiento

Se puede establecer el idioma deseado. Las opciones de idioma son inglés, francés, alemán, español, italiano, portugués, sueco, ruso, griego, turco, holandés, checo, húngaro y polaco.

Funcionamiento del botón

1

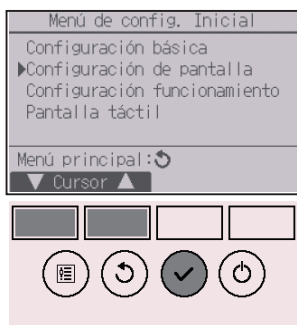

Seleccione “Configuración de pantalla” en el menú de configuración inicial y presione el botón **ACEPTAR**.

2

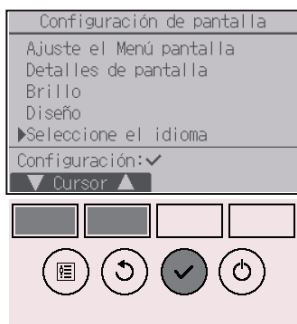

Mueva el cursor a “Seleccione el idioma” con el botón **F1** o **F2**, y presione el botón **ACEPTAR**.

3

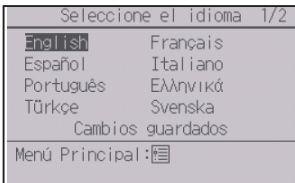
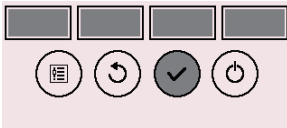
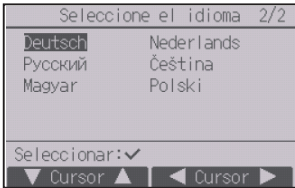
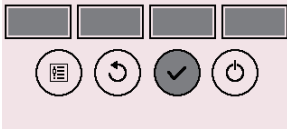
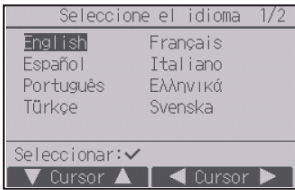

Mueva el cursor al idioma que desee con los botones **F1** a **F4**, y presione el botón **ACEPTAR** para guardar la configuración.

Quando se conecta la alimentación por primera vez, se muestra la pantalla de seleccione el idioma. Seleccione el idioma deseado. El sistema no arrancará si no se selecciona ningún idioma.

Aparecerá una pantalla indicando que se ha guardado la configuración.

Navegación por las pantallas

- Para volver al Menú principal Botón **MENÚ**
- Para volver a la pantalla anterior Botón **VOLVER**

Opciones de configuración de las funciones

Diseño



Funcionamiento del botón

1

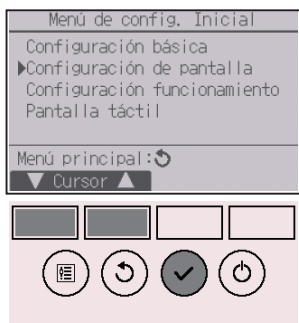

Seleccione “Configuración de pantalla” en el menú de configuración inicial y presione el botón **ACEPTAR**.

2

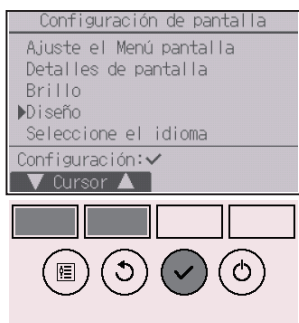

Mueva el cursor a “Diseño” con el botón **F1** o **F2**, y presione el botón **ACEPTAR**.

3



Seleccione “Color” con el botón **F4**.

- Color: Es posible seleccionar el color de la pantalla. (Consulte la página siguiente.)
- Blanco: Pantalla monocromo (basada en blanco)
- Negro: Pantalla monocromo (basada en negro)

Si selecciona “Blanco” o “Negro”, presione el botón **ACEPTAR**. Si selecciona “Color”, seleccione el color que desee consultando la página siguiente.

4



Seleccione el elemento siguiente con el botón **F1** o **F2**, y configure el color de visualización que desee para cada elemento.

- Matiz de color: Configure el matiz del color con el botón **F3** o **F4**. (El rango configurable es de -90 a 89).
- Estampado: Configure el color con el botón **F4**.
- Color aj. a: Seleccione "Carácter" o "Fondo" como destino en el que se aplica el color con el botón **F4**.

El color de ejemplo debajo de los botones de función cambiará según el ajuste seleccionado.

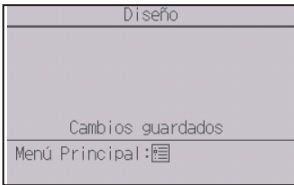

Seleccione el color que desee y presione el botón **ACEPTAR**.

Navegación por las pantallas

- Para volver al Menú principal Botón **MENÚ**
- Para volver a la pantalla anterior Botón **VOLVER**

Opciones de configuración de las funciones

Calibración de la pantalla táctil



Funcionamiento del botón

1

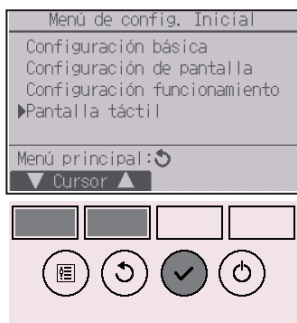

Seleccione “Pantalla táctil” en el menú de configuración inicial y presione el botón **ACEPTAR**.

2



Mueva el cursor a “Calibración pantalla táctil” con el botón **F1** o **F2**, y presione el botón **ACEPTAR**.

3

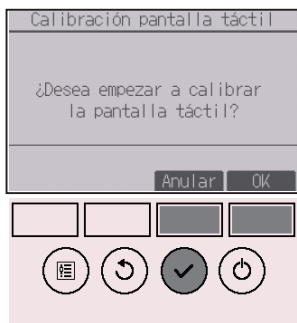

Aparecerá una ventana de confirmación. Seleccione “Anular” o “OK” con el botón **F3** o **F4**, y presione el botón **ACEPTAR**.

4

Toque los puntos negros en el orden en que aparecen en pantalla.
Habrá nueve en total.

Toque los puntos negros con un lápiz táctil en un minuto, empezando por la esquina superior izquierda.

Toque los nueve puntos negros en el orden en el que aparecen en pantalla.

Después de tocar los nueve puntos, la calibración habrá finalizado, y la pantalla regresará al menú de pantalla táctil.

- Si la pantalla táctil no se toca durante un minuto, la calibración se cancelará y la visualización regresará automáticamente a la pantalla anterior.
- Para calibrar correctamente la pantalla táctil, utilice un objeto puntiagudo pero no afilado para tocar los puntos.
 - * Un objeto afilado podría dañar o rallar la pantalla táctil.

Opciones de configuración de las funciones

Limpieza de la pantalla táctil



Funcionamiento del botón

1

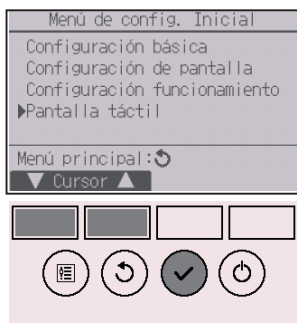

Seleccione “Pantalla táctil” en el menú de configuración inicial y presione el botón **ACEPTAR**.

2

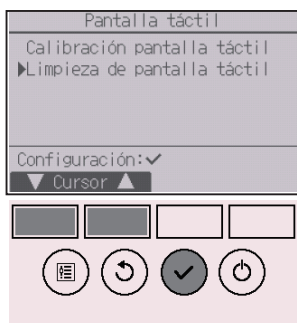

Mueva el cursor a “Limpieza de pantalla táctil” con el botón **F1** o **F2**, y presione el botón **ACEPTAR**.

3

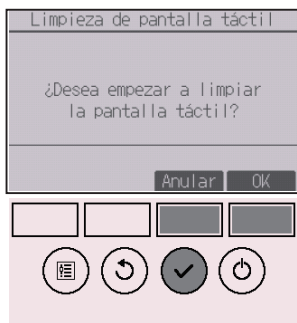

Aparecerá una ventana de confirmación. Seleccione “Anular” o “OK” con el botón **F3** o **F4**, y presione el botón **ACEPTAR**.

4



Esta pantalla permite al usuario limpiar la pantalla táctil durante 30 segundos sin cambiar de forma accidental ningún ajuste.

La pantalla regresará al menú de pantalla táctil una vez transcurridos los 30 segundos.

- Limpie la pantalla con un paño suave y seco, con un trapo humedecido con agua y detergente neutro o con un paño humedecido con etanol. No utilice ningún disolvente ácido, alcalino ni orgánico.

Opciones de configuración de las funciones

Inicializar controlador remoto



Descripción del funcionamiento

El controlador remoto puede inicializarse al estado de envío de fábrica. Debe tenerse en cuenta que se inicializarán los siguientes datos.

El controlador remoto se iniciará automáticamente una vez inicializado.

Configuración del programador, configuración del programador semanal, configuración del modo silencioso de la unidad exterior, configuración del ahorro energía, configuración de la opción de ahorro energía, configuración de la hora, configuración del horario de verano, configuración de la pantalla principal, configuración del brillo, configuración de los detalles de pantalla, configuración del diseño, configuración del modo automático, configuración del nombre del modelo, configuración del número de serie, configuración del información de contacto, información de error, contraseña de administrador, contraseña de mantenimiento

Funcionamiento del botón

1

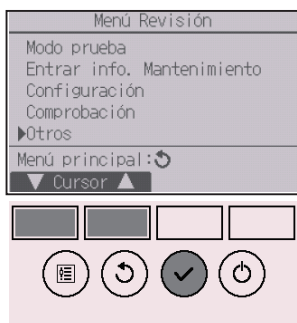

Seleccione “Otros” en el menú de revisión y presione el botón **ACEPTAR**.

2

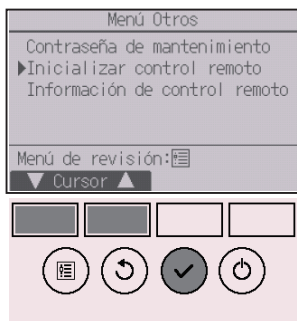

Mueva el cursor a “Inicializar control remoto” con el botón **F1** o **F2**, y presione el botón **ACEPTAR**.

3

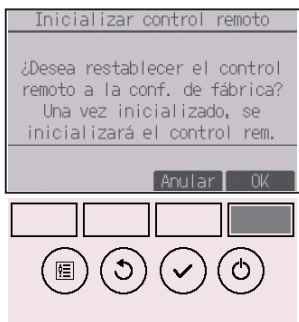

Seleccione "OK" con el botón **[F4]**.

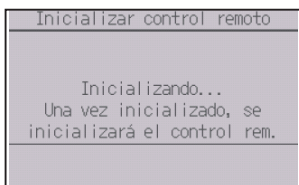

El controlador remoto se iniciará automáticamente una vez inicializado.

Opciones de configuración de las funciones

Información de controlador remoto



Descripción del funcionamiento

Puede comprobarse la información del controlador remoto en uso.

Funcionamiento del botón

1



Seleccione “Otros” en el menú de revisión y presione el botón **ACEPTAR**.

2

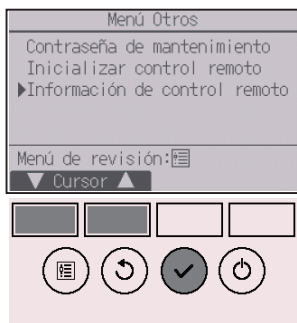

Mueva el cursor a “Información de control remoto” con el botón **F1** o **F2**, y presione el botón **ACEPTAR**.

3

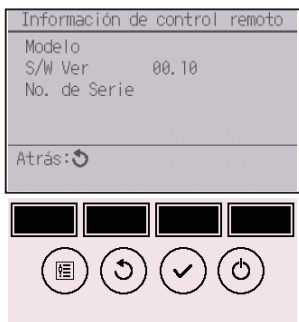

Puede comprobarse el nombre de modelo, la versión del software y el número de serie del controlador remoto en uso.

Resolución de problemas

Información de errores

Si se produce un error, aparecerá la pantalla siguiente y el LED de funcionamiento parpadeará. Revise el estado del error, detenga la operación y consulte a su distribuidor.

Funcionamiento del botón

1

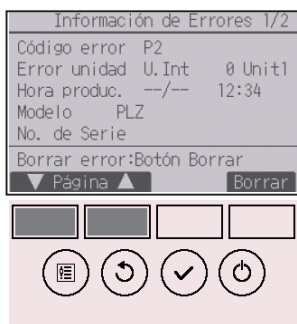

Se mostrará el código de error, la unidad de error, la dirección de refrigerante, el nombre de modelo de la unidad, la fecha y hora del error y el número de serie. El nombre de modelo y el número de serie solamente aparecerán si se ha registrado la información.

Presione el botón **F1** o **F2** para ir a la página siguiente.

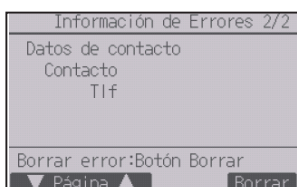

La información de contacto (número de teléfono del distribuidor) aparecerá solamente si se ha registrado la información.

2



Presione el botón **[F4]** o el botón **[ON/OFF]** para restaurar el error.

No se pueden restaurar los errores con la operación de ENCENDIDO/APAGADO prohibida.



Seleccione "OK" con el botón **[F4]**.

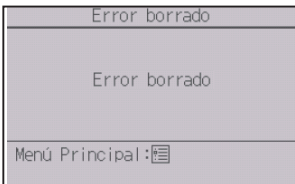

Aparecerá una ventana de confirmación.

Navegación por las pantallas

- Para volver al Menú principal Botón **[MENÚ]**

Resolución de problemas

Comprobar la información del error



Si no hay errores, se puede consultar la página 2/2 de información del error (consulte la página 74) desde el menú de operaciones.

Seleccione menú "Mantenimiento" en el menú principal y presione el botón **ACEPTAR**.

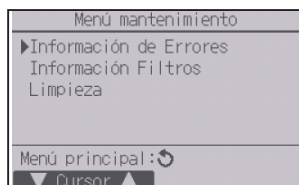

Para visualizar la pantalla de información de errores, seleccione "Información de Errores" en el menú de mantenimiento.

Los errores no se pueden restablecer.

Auto-OFF no ocupación

La pantalla siguiente aparecerá para el modo de panel 3D i-See sensor cuando la unidad se pare debido a la función Auto-OFF no ocupación de la opción de ahorro energía.

Consulte el libro de instrucciones de la unidad para interiores para la configuración del 3D i-See sensor.

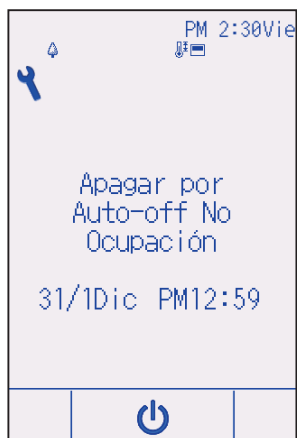

Mantenimiento

Información de filtros



 aparecerá en la pantalla de estado y en la pantalla principal en el modo Completo cuando sea necesario limpiar los filtros.

Limpie, lave o cambie los filtros cuando aparezca esta señal.

Consulte el Manual de instalación de la unidad interior para obtener más detalles.

Funcionamiento del botón

1



Seleccione "Información Filtros" en el menú de mantenimiento y presione el botón **ACEPTAR**.

2



Presione el botón **F4** para restaurar la señal de filtro. Consulte el libro de Instrucciones de la unidad interior para ver cómo se limpia el filtro.

3



Seleccione "OK" con el botón **[F4]**.

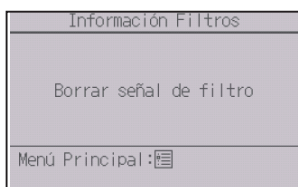

Aparecerá una ventana de confirmación.

Navegación por las pantallas

- Para volver al Menú principal Botón **[MENÚ]**
- Para volver a la pantalla anterior Botón **[VOLVER]**



Cuando se muestra  en la pantalla de estado y en la pantalla principal en el modo Completo, el sistema está controlado a nivel central y no se puede restaurar la señal del filtro.

Si hay dos o más unidades interiores conectadas, el momento de cambiar el filtro para cada unidad puede ser diferente, dependiendo del tipo de filtro.

Aparecerá el icono  cuando haya que limpiar el filtro en la unidad principal.

Cuando se restaura la señal del filtro, se restaurará el tiempo de funcionamiento acumulativo de todas las unidades.

El icono  está programado para aparecer tras un determinado periodo de funcionamiento, partiendo de la base que las unidades interiores están ubicadas en un espacio con calidad de aire normal. Dependiendo de la calidad del aire, puede que haya que cambiar el filtro con más frecuencia.

El tiempo acumulativo en el cual hay que cambiar el filtro depende del modelo.

Especificaciones

Especificaciones del controlador

	Especificaciones
Tamaño del producto	Estándar (PAR-CT01MAA(R)-SB/PAR-CT01MAA-S): 65(An.) × 120(Al.) × 14,1(P) mm (2 9/16 × 4 23/32 × 9/16 [pulgadas]) (sin incluir la parte sobresaliente)
	Premium (PAR-CT01MAA(R)-PB): 68(An.) × 120(Al.) × 14,1(P) mm (2 11/16 × 4 23/32 × 9/16 [pulgadas]) (sin incluir la parte sobresaliente)
Peso neto	Estándar (PAR-CT01MAA(R)-SB/PAR-CT01MAA-S): 0,09 kg (13/64 libras)
	Premium (PAR-CT01MAA(R)-PB): 0,10 kg (7/32 libras)
Voltaje de alimentación	12 VCC (proporcionada desde las unidades interiores)
Consumo de corriente	0,6 W
Entorno operativo	Temperatura 0 ~ 40°C (32 ~ 104°F) Humedad 25 ~ 90%RH (sin condensación)
Material	Estándar (PAR-CT01MAA(R)-SB/PAR-CT01MAA-S) Cuerpo principal: ABS
	Premium (PAR-CT01MAA(R)-PB) Cuerpo principal: ABS Placa lateral: Aluminio

Lista de funciones (con fecha del 1 de octubre de 2017)

○ : Soportado × : No soportado

	Función	CITY MULTI	Mr. SLIM	Requiere contraseña
Potencia	ENCENDIDO/APAGADO	○	○	-
Configuración	Modo de funcionamiento	○	○	-
	Modo "Auto" (punto de ajuste doble)	○	○	-
	Temperatura preestablecida	○	○	-
	Velocidad del ventilador	○	○	-
	Lama	○	○	-
	Deflector	○	○	-
	Ventilación	○	○	-
Menú de operaciones	Super	×	○	-
	Ángulo lama manual	○	○	-
	3D i-See sensor	○	○	-
Menú de programador	Programador (Programador On/Off)	○	○	administrador
	Programador (Programador Auto-Off)	○	○	administrador
	Programador semanal	○	○	administrador
	Unidad exterior modo silencioso	○	○	administrador
	Modo noche	○	○	administrador
Menú de ahorro energía	Restricción del rango de temperatura	○	○	administrador
	Función de bloqueo de operación	○	○	administrador
	Auto recuperación	○	○	administrador
	Calendario	×	○	administrador
Menú de configuración inicial	Hora	○	○	administrador
	Configuración del formato de configuración hora	○	○	administrador
	Horario de verano	○	○	administrador
	Pantalla principal	○	○	administrador
	Explicación de los iconos	○	○	administrador
	Brillo	○	○	administrador
	Seleccione el idioma	○	○	administrador
	Diseño	○	○	administrador
	Calibración de la pantalla táctil	○	○	administrador
	Limpieza de la pantalla táctil	○	○	administrador
Menú de revisión	Contraseña (administrador)	○	○	administrador
	Inicializar controlador remoto	○	○	mantenimiento
	Información de controlador remoto	○	○	mantenimiento
	Modo prueba	○	○	mantenimiento
	Introducir información del modelo	○	○	mantenimiento
	Introducir teléfono de contacto	○	○	mantenimiento
	Configuración las funciones	○	○	mantenimiento
	Mantenimiento adecuado	×	○	mantenimiento
Menú de mantenimiento	Contraseña (mantenimiento)	○	○	mantenimiento
	Panel autodescendente	○	○	-
	Información de errores	○	○	-
	Información de filtros	○	○	-

* Las funciones soportadas varían dependiendo del modelo de la unidad.

Especificaciones

Listado de funciones que pueden o no ser utilizadas en combinación

	Super	Programador On/Off	Programador Auto-Off	Programador semanal	Unidad exterior modo silencioso	Rango de temperatura	Operación bloqueada	Auto recuperación	Programación de ahorro energía	Modo noche
Super		○	○	○	△ 1	○	△ 2	○	△ 1	○
Programador On/Off	○		○	× 1	○	○	○	○	○	△ 3
Programador Auto-Off	○	○		○	○	○	○	○	○	△ 4
Programador semanal	○	× 1	○		○	○	○	○	○	△ 5
Unidad exterior modo silencioso	△ 1	○	○	○		○	○	○	○	○
Rango de temperatura	○	○	○	○	○		○	× 2	○	△ 6
Operación bloqueada	△ 2	○	○	○	○	○		○	○	○
Auto recuperación	○	○	○	○	○	× 2	○		○	△ 7
Programación de ahorro energía	△ 1	○	○	○	○	○	○	○		○
Modo noche	○	△ 3	△ 4	△ 5	○	△ 6	○	△ 7	○	

○: Se pueden utilizar en combinación ×: No se pueden utilizar en combinación △: Restringido

△ 1: Esta función se habilita tras haber finalizado el funcionamiento a alta potencia porque el funcionamiento a alta potencia tiene mayor prioridad.

△ 2: Esta función no se puede operar con alguna operación bloqueada.

△ 3: La función de modo noche no se puede utilizar cuando la unidad es manejada por el Programador On/Off.

△ 4: La función de Programador Auto-Off no se puede utilizar en el modo noche.

△ 5: La función de modo noche no se puede utilizar cuando la unidad es manejada por la configuración del Programador semanal.

△ 6: La función de configuración de rango de temperatura no se puede utilizar en el modo noche.

△ 7: La función de Auto recuperación no se puede utilizar en el modo noche.

× 1: La configuración del Programador semanal no es efectiva porque el Programador On/Off tiene mayor prioridad.

× 2: Tampoco se puede utilizar la función de Auto recuperación porque la configuración de rango de temperatura tiene más prioridad.

Sistema di controllo CITY MULTI
e condizionatori d'aria Mitsubishi Mr. SLIM

Unità di controllo remoto a schermo tattile MA

PAR-CT01MAA-PB
PAR-CT01MAA-SB
PAR-CT01MAA-S
PAR-CT01MAR-PB
PAR-CT01MAR-SB

Italiano

Libretto di istruzioni



Prima dell'uso, leggere attentamente le istruzioni in questo manuale per utilizzare correttamente il prodotto.

Conservare come riferimento futuro.

Assicurarsi che il CD-ROM e il Manuale di installazione siano trasferiti agli utenti successivi.



Per assicurare il funzionamento corretto e sicuro del controllo remoto, questo deve essere installato solo da personale qualificato.

Indice

Norme di sicurezza	4
Componenti dell'unità di controllo	6
Interfaccia dell'unità di controllo - Display Stato/Display principale..	6
Interfaccia dell'unità di controllo - Schermata Menu	8
Display- Display Stato/Display principale	10
Struttura del menu e icone	12
Struttura del menu	12
Spiegazione icone	15
Operazioni di base	16
Alimentazione ON/OFF.....	16
Impostazioni modalità operativa, temperatura, velocità ventilatore, deflettore, louver e recupero (Lossnay)	17
Navigazione all'interno del menu	22
Elenco Menu principale	22
Navigazione all'interno del Menu principale	24
Impostazioni funzione	25
High Power	25
Angolo deflettore manuale.....	26
Timer (On/Off Timer).....	29
Timer (Timer Auto-Off)	32
Timer settimanale	34
Modo silenzioso Unità Esterna	37
Riduzione notturna.....	40
Restrizioni	43
Risparmio energia.....	49
Orologio	54
Ora legale	56
Imposta display principale	58
Spiegazione icone	59
Luminosità.....	61
Selezione lingua	62
Design.....	64
Calibrazione schermo tattile	66
Pulizia dello schermo tattile	68
Reset controllo remoto.....	70
Informazioni controllo remoto	72
Risoluzione dei problemi	74
Informazione errore	74
Spegnimento automatico assenza	77
Manutenzione	78
Informazione filtro aria	78
Specifiche	80
Specifiche controllo.....	80
Elenco delle funzioni (in data 1 ottobre 2017)	81
Elenco delle funzioni che possono/non possono essere usate in combinazione....	82

Norme di sicurezza

- Leggere attentamente le seguenti precauzioni di sicurezza prima di utilizzare l'unità.
- Attenersi rigorosamente a queste precauzioni per garantire la sicurezza propria e degli altri.

 PERICOLO	Indica pericolo di morte o di gravi lesioni personali.
 ATTENZIONE	Indica pericolo di gravi lesioni personali o danni strutturali.

- Dopo aver letto questo manuale, consegnarlo all'utente finale, in modo che possa consultarlo in futuro.
- Conservare questo manuale per consultarlo in futuro e come riferimento in caso di necessità. Questo manuale deve essere disponibile a chi si occupa della riparazione o del riposizionamento dell'unità di controllo. Assicurarsi che il manuale venga consegnato agli utenti che potrebbero averne bisogno in futuro.

Precauzioni generali

PERICOLO

Non installare l'unità in luoghi nei quali sono presenti grandi quantità di olio, vapore, solventi organici o gas corrosivi come lo zolfo o nei quali si utilizzano spesso soluzioni o spray a base acida/alkalina. Queste sostanze possono compromettere le prestazioni dell'unità o corrodere alcuni componenti, con conseguente pericolo di scosse elettriche, malfunzionamenti, fumo o incendi.

Per ridurre il rischio di corto circuito, dispersione di corrente, scosse elettriche, malfunzionamenti, fumo o incendi, non lavare l'unità di controllo con acqua o altri liquidi.

Per ridurre il rischio di scosse elettriche, malfunzionamenti, fumo o incendi, non premere gli interruttori o i tasti né toccare altre parti elettriche con le mani bagnate.

Se si disinfetta l'unità con alcol, aerare adeguatamente il locale. I fumi dell'alcol potrebbero provocare incendi o esplosioni all'accensione dell'unità.

Per ridurre il rischio di lesioni personali o scosse elettriche, spegnere e coprire l'unità di controllo prima di spruzzare prodotti chimici intorno all'unità.

Per ridurre il rischio di lesioni personali o scosse elettriche, spegnere l'unità e scollegarla dalla presa elettrica prima di pulire, sottoporre a manutenzione o ad ispezione.

Se si notano anomalie (ad esempio, puzza di bruciato), arrestare il funzionamento, scollegare l'alimentazione elettrica e contattare immediatamente il rivenditore. L'uso continuato del prodotto potrebbe provocare scosse elettriche, malfunzionamenti o incendi.

Installare in maniera adeguata tutte le coperture necessarie per evitare che umidità e polvere possano entrare nell'unità di controllo. L'accumulo di polvere e l'acqua possono causare scosse elettriche, fumo o incendi.

ATTENZIONE

Per ridurre il rischio di incendi o esplosioni, evitare di tenere materiali infiammabili o di utilizzare spray infiammabili nelle vicinanze dell'unità di controllo.

Per ridurre il rischio di danni all'unità di controllo, non spruzzare direttamente insetticidi o altri spray infiammabili sull'unità di controllo.

Per ridurre il rischio di inquinamento ambientale, contattare una concessionaria autorizzata per l'adeguato smaltimento del controllo remoto.

Per ridurre il rischio di scosse elettriche o malfunzionamenti, non toccare schermo tattile, interruttori o tasti con oggetti appuntiti o affilati.

Per ridurre il rischio di lesioni personali o scosse elettriche, evitare il contatto con i bordi appuntiti di determinate parti.

Per evitare lesioni personali causate da vetri rotti, non applicare forza eccessiva sulle parti in vetro.

Per ridurre il rischio di lesioni personali, indossare di equipaggiamento di protezione quando si interviene sull'unità di controllo.

Precauzioni per spostare o riparare l'unità di controllo

PERICOLO

L'unità di controllo deve essere spostata o riparata solo da personale qualificato. Non smontare né modificare l'unità di controllo. L'installazione o la riparazione impropria dell'unità causare lesioni personali, scosse elettriche o incendi.

ATTENZIONE

Per ridurre il rischio di corto circuito, scosse elettriche, incendi o malfunzionamenti, non toccare la scheda elettronica con attrezzi o con le mani ed evitare l'accumulo di polvere.

Precauzioni aggiuntive

Utilizzare gli attrezzi adeguati per installare, ispezionare o riparare l'unità di controllo per evitare di danneggiarla.

Questa unità di controllo è progettata per essere utilizzata esclusivamente con il sistema di aria condizionata per edifici di Mitsubishi Electric. L'eventuale uso di questa unità di controllo con altri sistemi o per altri scopi potrebbe causare malfunzionamenti.

L'apparecchio non è destinato all'uso da parte di persone (inclusi bambini) con capacità fisiche, sensoriali o mentali ridotte, o con esperienza e conoscenza insufficienti, a meno che siano sorvegliati o ricevano apposite istruzioni per l'uso dell'apparecchio da una persona responsabile della loro sicurezza. Sorvegliare i bambini affinché non giochino con l'apparecchio.

Per evitare che si scolori, non usare benzene, diluente o panni con sostanze chimiche per pulire l'unità di controllo. A questo scopo, utilizzare un panno morbido leggermente bagnato con acqua e un detergente leggero, pulire il detergente con un panno umido e togliere l'acqua con un panno asciutto.

Per evitare di danneggiare l'unità di controllo, assicurare che sia protetta dall'elettricità statica.

Questo apparecchio è destinato all'uso da parte di utenti esperti o qualificati in negozi, nell'industria leggera e nelle aziende agricole o per l'uso commerciale da parte di non professionisti.

Se il cavo di alimentazione è danneggiato, deve essere sostituito dal produttore, da un rappresentante autorizzato o da un tecnico qualificato per ragioni di sicurezza.

Componenti dell'unità di controllo

Interfaccia dell'unità di controllo - Display Stato/Display principale

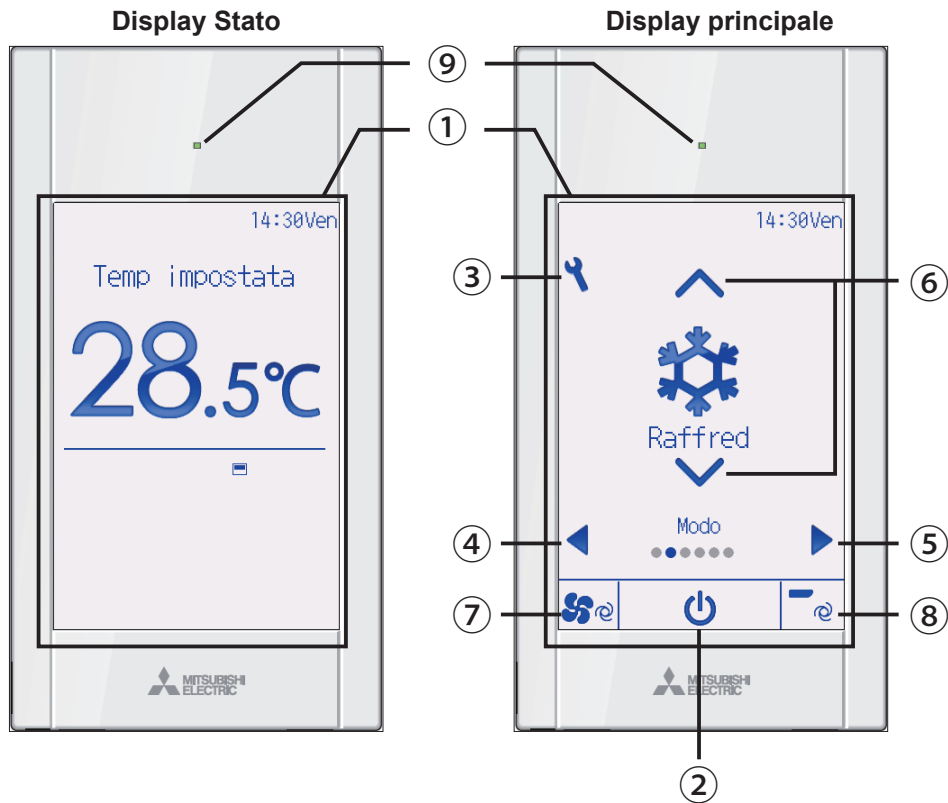

① Schermo tattile e LCD retroilluminato full color

Apparirà l'impostazione dell'operazione. Quando la retroilluminazione è disattivata, premere un punto qualsiasi per passare al Display Stato. Durante la visualizzazione del Display Stato, facendo pressione su qualsiasi area la schermata passerà a Imposta display principale.

② Tasto **ON/OFF**

Premere per accendere/spegnere (ON/OFF) l'unità interna.

③ Tasto **Impostazione**

Premere per attivare il Menu principale. Quando il funzionamento del menu si blocca, è necessaria la password da amministratore.

④ Tasto

Premere per scorrere le voci di impostazione nel seguente ordine: louver, recupero, deflettore, velocità ventilatore, modalità operativa e temperatura preimpostata.

⑤ Tasto

Premere per scorrere le voci di impostazione nel seguente ordine: temperatura preimpostata, modalità operativa, velocità ventilatore, deflettore, recupero e louver.

⑥ Tasto

Premere per modificare i valori dell'impostazione selezionata ai punti ④ e ⑤ precedenti.

⑦ Tasto collegamento a velocità ventilatore

Premere per accedere direttamente alla schermata di impostazione della velocità del ventilatore.

⑧ Tasto collegamento deflettore

Premere per accedere direttamente alla schermata di impostazione del deflettore.

⑨ Lampada ON/OFF

La luce verde si accende quando l'unità è in funzione, a meno che "Illumin. LED" non sia impostato su "No". Essa lampeggia quando il controllo remoto è in avviamento o se si è verificato un errore.

Quando il funzionamento ON/OFF è bloccato, ② non verrà visualizzato.

Se si seleziona una voce di impostazione con i tasti ④ o ⑤, essa non verrà visualizzata se il suo funzionamento è bloccato.

Se il funzionamento della velocità del ventilatore o il deflettore sono bloccati, le voci ⑦ o ⑧ non verranno visualizzate.

I valori di impostazione non possono essere modificati con il tasto ⑥ se la voce di impostazione è controllata in maniera centrale dal controller di sistema.

Componenti dell'unità di controllo

Interfaccia dell'unità di controllo - Schermata Menu



① Tasto **ON/OFF**

Premere per accendere/spegnere (ON/OFF) l'unità interna.

② Tasto **SCEGLI**

Premere per salvare le impostazioni.

③ Tasto **INDIETRO**

Premere per tornare alla schermata precedente.

Quando è visualizzato il Menu principale, premendo questo tasto verrà visualizzato il Display Stato.

④ Tasto **MENU**

Pagina 24

Premere per attivare il Menu principale.

⑤ Tasto funzione **F1**

Schermata Menu: La funzione dei tasti varia in base alla schermata.

⑥ Tasto funzione **F2**

Menu principale: Premere per spostare il cursore a sinistra.

Schermata Menu: La funzione dei tasti varia in base alla schermata.

⑦ Tasto funzione **F3**

Menu principale: Premere per spostare il cursore a destra.

Schermata Menu: La funzione dei tasti varia in base alla schermata.

⑧ Tasto funzione **F4**

Schermata Menu: La funzione dei tasti varia in base alla schermata.

Le funzioni dei tasti funzione variano secondo la schermata. Consultare la guida ai tasti funzione in basso sull'LCD per le funzioni relative alla schermata corrente.

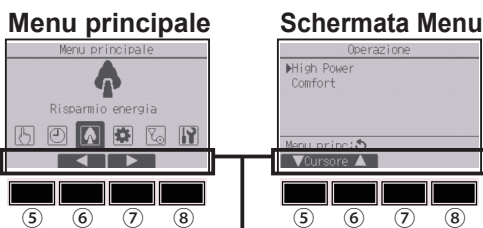

Guida alle funzioni

Componenti dell'unità di controllo

Display- Display Stato/Display principale

Il Display Stato e il display principale possono essere visualizzati in due modi: "Completo" e "Base".

L'impostazione predefinita di fabbrica è "Completo". Per le istruzioni relative al cambiamento della modalità, fare riferimento alla pagina 58.

Modo completo

* Sono visualizzate tutte le icone per la definizione.

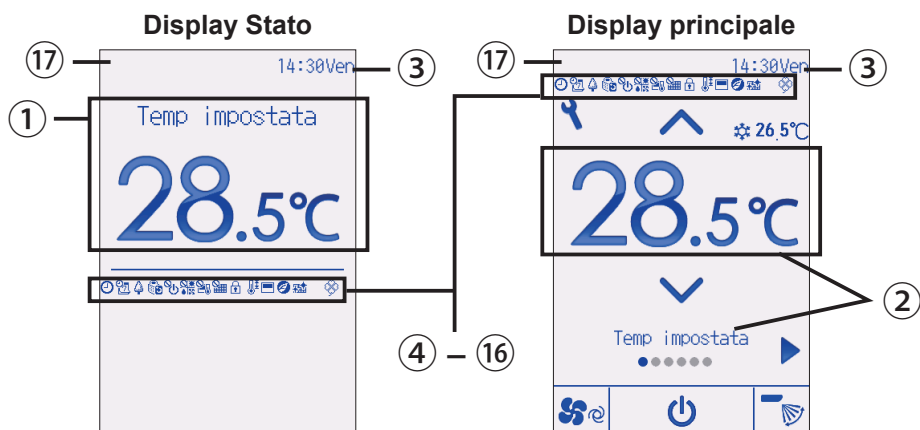

Modo base

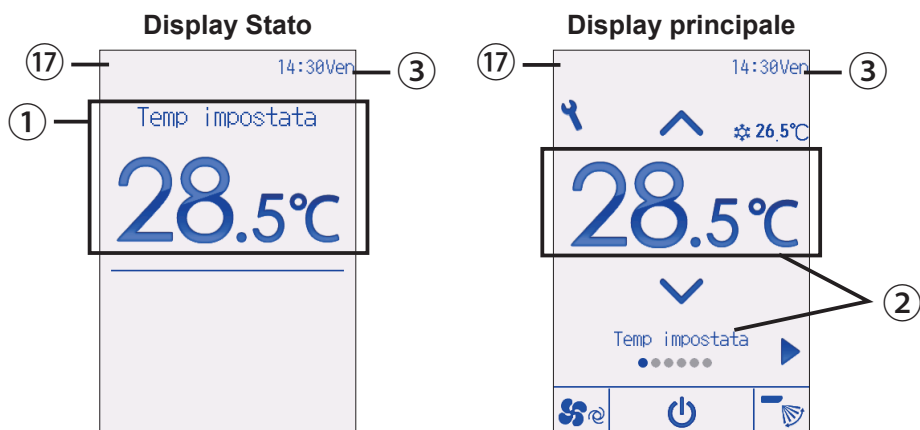

① Temperatura preimpostata o temperatura ambiente

Visualizza la temperatura preimpostata o la temperatura ambiente.
(consultare il manuale di installazione).

② Voce di impostazione e valori di impostazione **Pagina 17**

Visualizza le voci di impostazione “Temperatura preimpostata” ↔ “Modalità operativa” ↔ “Velocità ventilatore” ↔ “Deflettore” ↔ “Recupero” ↔ “Louver” e i rispettivi valori di impostazione. “Controllo centralizzato” appare per un certo periodo di tempo quando si utilizza una voce controllata in modo centralizzato.

③ Orologio

Visualizza l'ora corrente.
(consultare il manuale di installazione).

④ **Pagina 29, 32, 40**

Appare quando viene abilitata la funzione “On/Off Timer” (Pagina 29), “Riduzione notturna” (Pagina 40), o “Timer Auto-Off” (Pagina 32).

 appare quando il timer viene disabilitato dal sistema di controllo centralizzato.

⑤ **Pagina 34**

Appare quando è attivato il Timer settimanale.

⑥ **Pagina 51**

Appare quando le unità sono in modalità risparmio energetico. (Non apparirà su alcuni modelli di unità interne)

⑦ **Pagina 37**

Appare quando le unità esterne sono in modalità silenziosa.

⑧

Appare quando il funzionamento ON/OFF è controllato in maniera centrale.

⑨

Appare quando la modalità operativa è controllata in maniera centrale.

⑩

Appare quando la temperatura preimpostata è controllata in maniera centrale.

⑪

Appare quando la funzione reset del filtro è controllata in maniera centrale.

⑫ **Pagina 46**

Appare quando i tasti sono bloccati.

⑬ **Pagina 43**

Appare quando il range della temperatura preimpostato è limitato.

⑭

Appare quando il termistore integrato sul controllo remoto è attivato per monitorare la temperatura ambiente.

 appare quando il termistore sull'unità interna è attivato per monitorare la temperatura ambiente.

⑮

Appare quando viene attivato il programma Risparmio energetico tramite la funzione “3D i-See sensor”.

⑯ **Pagina 78**

Indica quando è necessaria la manutenzione del filtro.

⑰ **Display errore preliminare**

Appare un codice errore durante l'errore preliminare.

Struttura del menu e icone

Struttura del menu

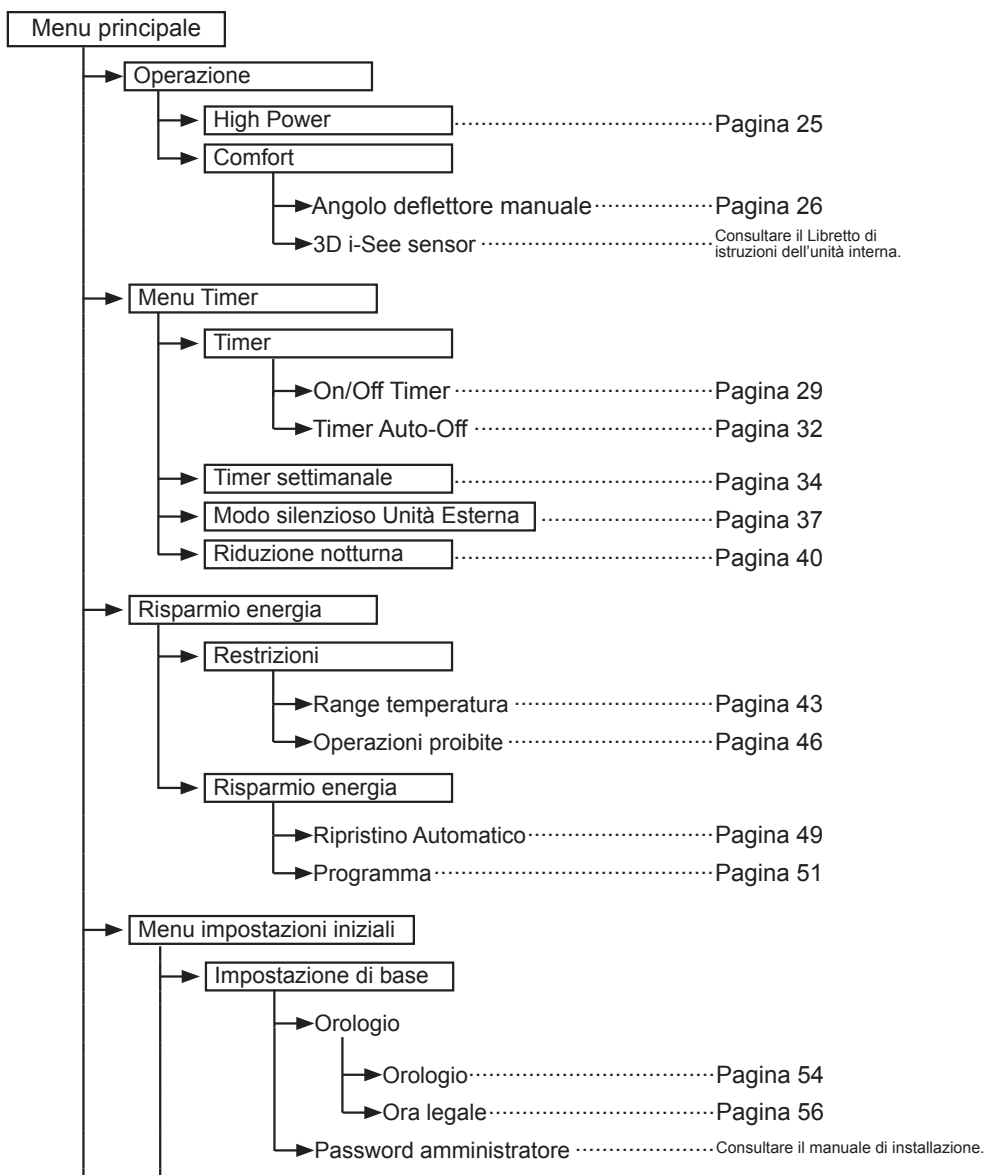

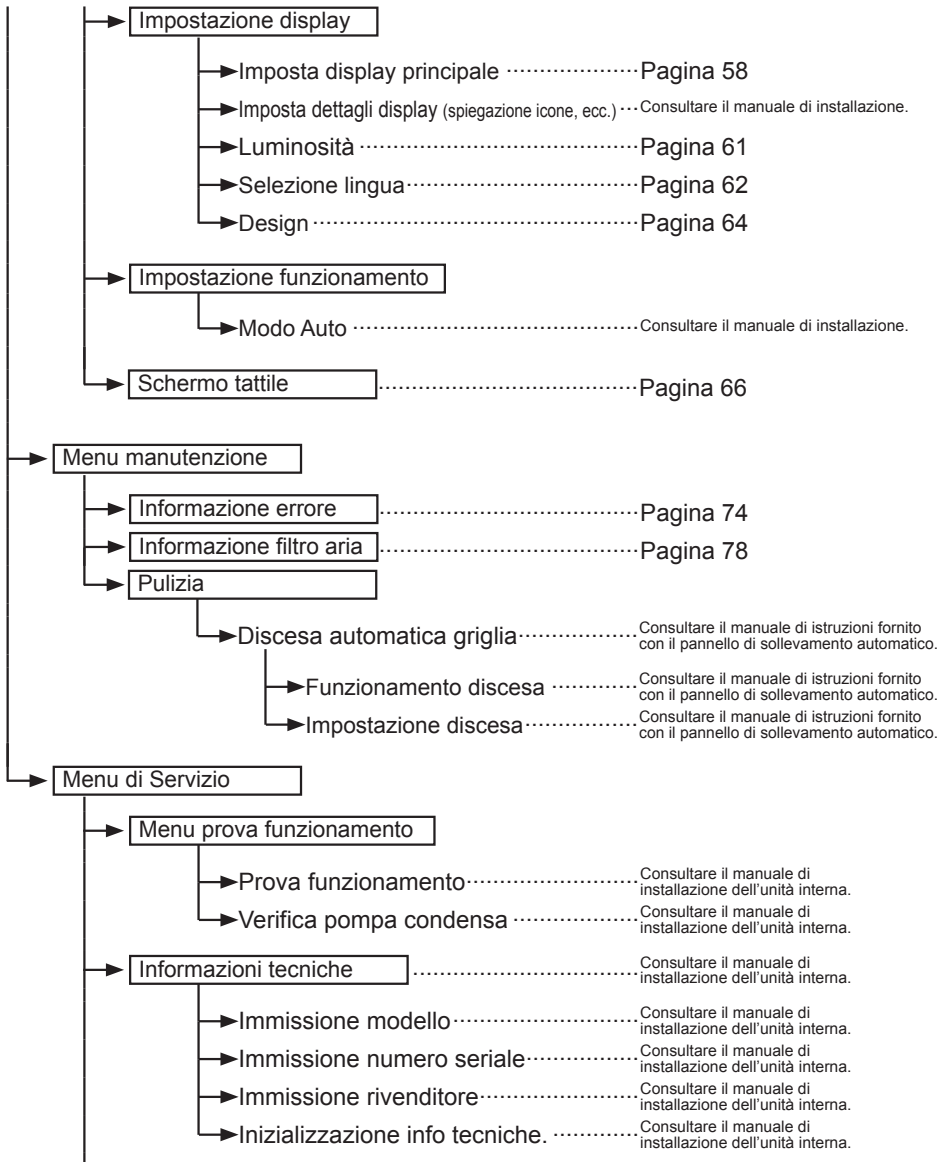

Struttura del menu e icone

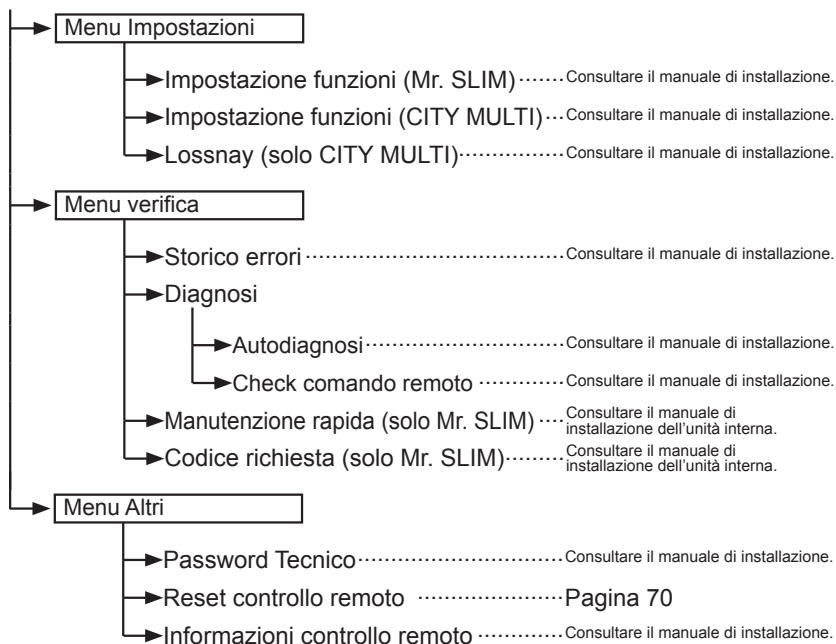

Non tutte le funzioni sono disponibili sui modelli delle unità interne.

Spiegazione icone

Funzionamento dell'unità di controllo

Timer



La tabella seguente riassume le icone quadrate utilizzate in questo manuale.



Per modificare le impostazioni, occorre inserire la password amministratore o manutenzione utente sulla schermata inserimento password. Nessuna impostazione può ignorare questo processo.



F1 F2 F3 F4

- F1** : premere per spostare il cursore a sinistra.
- F2** : premere per spostare il cursore a destra.
- F3** : premere per diminuire il valore di 1.
- F4** : premere per aumentare il valore di 1.

* Non è possibile effettuare modifiche senza aver inserito la password corretta.



Indica che le impostazioni possono essere modificate solo quando le unità sono in funzione.



Indica che le impostazioni possono essere modificate solo quando le unità non sono in funzione.



Indica che le impostazioni possono essere modificate solo quando le unità sono in modo Raffreddamento, Riscaldamento o Auto.



Indica che le funzioni non sono disponibili quando i tasti sono bloccati o se il sistema è controllato in maniera centrale.

Operazioni di base

Alimentazione ON/OFF



Tasto di funzionamento

ON

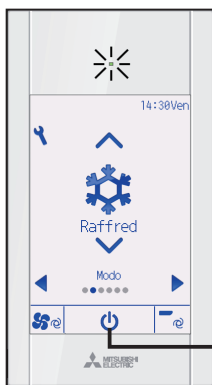

Premere il tasto **ON/OFF**.

La lampada ON/OFF sarà verde e si avvierà il funzionamento.

Se "Illumin. LED" è impostato su "No", la lampada ON/OFF non si accenderà.

OFF



Premere di nuovo il tasto **ON/OFF**.

La lampada ON/OFF si spegne e si arresta il funzionamento.



Tasto di funzionamento

Modalità operativa

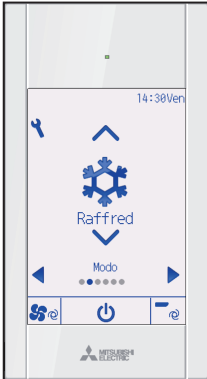

Ad ogni pressione dei tasti ▼ o ▲ si scorre tra le seguenti modalità operative.

Selezionare la modalità operativa desiderata.



Raffreddamento



Deumidificatore



Ventilatore



Auto



Riscaldamento

- Le modalità operative non disponibili per i modelli delle unità interne collegate non appaiono sullo schermo.

Icona modalità lampeggiante e suo significato

L'icona modalità lampeggia quando le unità interne presenti nello stesso sistema di raffreddamento (collegato alla stessa unità esterna) sono già operative ma con modalità differente. In questo caso, il resto dell'unità nello stesso gruppo può essere azionata solo con la stessa modalità.

<Modo Auto (impostazione punto doppio)>

Quando la modalità operativa è impostata su modo Auto (impostazione punto doppio), due temperature preimpostate (una per il raffreddamento e l'altra per il riscaldamento) possono essere impostate. A seconda della temperatura ambiente, l'unità interna funzionerà automaticamente in modo Raffreddamento o in modo Riscaldamento e manterrà la temperatura ambiente all'interno dell'intervallo di preselezione.

Il grafico seguente mostra il modello operativo dell'unità interna utilizzata in modo Auto (impostazione punto doppio).

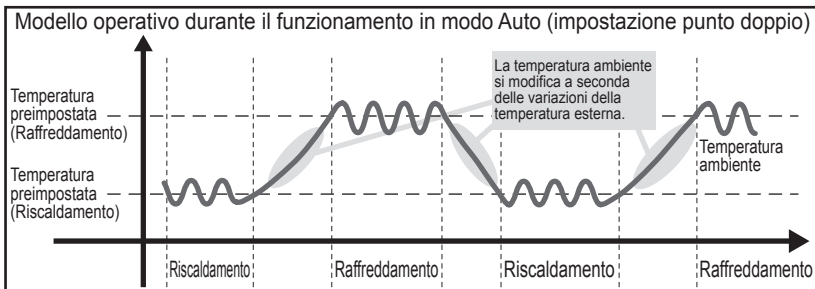

Operazioni di base

Temperatura preimpostata

<Raffreddamento, Deumidificatore, Riscaldamento e Auto (impostazione punto singolo)>



Premere il tasto ▼ per diminuire la temperatura preimpostata e il tasto ▲ per aumentarla.

- Fare riferimento alla tabella a pagina 19 per il range di temperatura configurabile per le diverse modalità operative.
- Il range della temperatura preimpostato non può essere configurato per il funzionamento Ventilatore/Recupero.
- La temperatura preimpostata sarà visualizzata in incrementi di 0,5 o di 1 gradi centigradi o Fahrenheit, a seconda del modello di unità interna e dell'impostazione del modo dello schermo sul controllo remoto.

<Modo Auto (impostazione punto doppio)>

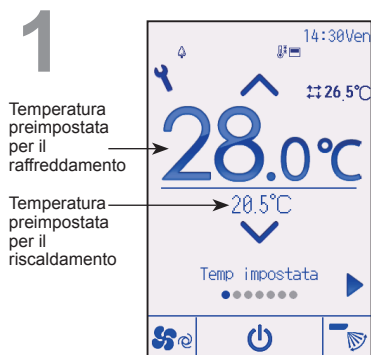

Appariranno le attuali temperature preimpostate.



Ad ogni pressione dei tasti ◀ o ▶ si passa dalle temperature preimpostate per il raffreddamento a quelle per il riscaldamento.

2

Temperatura preimpostata per il raffreddamento

Temperatura preimpostata per il riscaldamento



Premere il tasto  per diminuire la temperatura selezionata e il tasto  per aumentarla.

- Fare riferimento alla tabella seguente per il range di temperatura configurabile per le diverse modalità operative.
- Le impostazioni per le temperature preimpostate di raffreddamento e riscaldamento in modo Auto (impostazione punto doppio) vengono usate anche per i modi Raffreddamento/Deumidificatore e Riscaldamento.
- Le temperature preimpostate per il raffreddamento e il riscaldamento in modo Auto (impostazione punto doppio) devono soddisfare le seguenti condizioni:
 - La temperatura di raffreddamento preimpostata è superiore a quella della temperatura di riscaldamento preimpostata.
 - Il requisito per la differenza fra le temperature minime di raffreddamento e riscaldamento preimpostate (varia a seconda dei modelli di unità interne collegate) è soddisfatto.
 - Se le temperature sono impostate in modo da non soddisfare il requisito minimo della differenza di temperatura, entrambe le temperature preimpostate verranno automaticamente modificate entro i range di impostazione consentiti.

Range della temperatura preimpostato configurabile

Modalità operativa	Range della temperatura preimpostato
Raffreddamento/Deumidificatore	19 ~ 30°C (67 ~ 87°F)
Riscaldamento	17 ~ 28°C (63 ~ 83°F)
Auto (Impostazione punto singolo)	19 ~ 28°C (67 ~ 83°F)
Auto (Impostazione punto doppio)	[Raffreddamento] Range di temperatura preimpostato per il modo Raffreddamento [Riscaldamento] Range di temperatura preimpostato per il modo Riscaldamento
Ventilatore/Recupero	Non impostabile

Il range della temperatura configurabile varia secondo il modello delle unità interne.

Operazioni di base

Velocità ventilatore

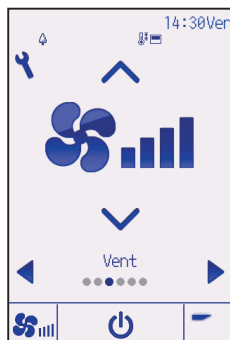

Ad ogni pressione dei tasti ▼ o ▲ si scorre tra le seguenti velocità del ventilatore.

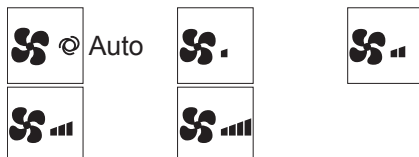

- Le velocità del ventilatore disponibili dipendono dai modelli delle unità interne collegate.

Impostazione del deflettore

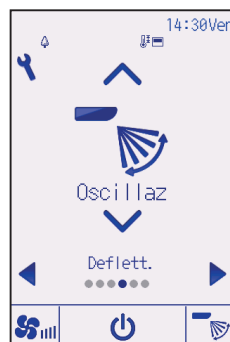

(schermata campione su CITY MULTI)

Ad ogni pressione dei tasti ▼ o ▲ si scorre tra le seguenti impostazioni del deflettore.

Selezionare l'impostazione desiderata.

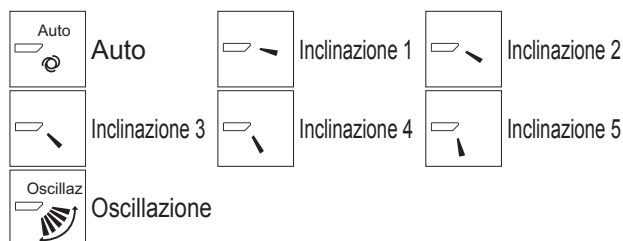

Selezionare "Oscillaz" per spostare i deflettori su e giù automaticamente.

Se impostato da "Inclinaz 1" a "Inclinaz 5", il deflettore verrà posizionato all'inclinazione selezionata.

- **1h** alla sinistra dell'icona dell'impostazione del deflettore. Questa icona appare quando il deflettore è impostato su Inclinazione 2, 3, 4 o 5 e il ventilatore opera a velocità bassa durante il raffreddamento o la deumidificazione (secondo il modello).

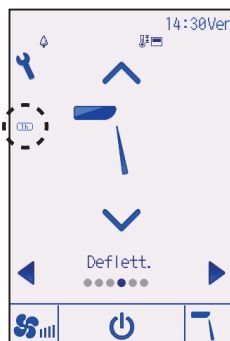

L'icona scompare dopo un'ora e l'impostazione del deflettore cambierà automaticamente.

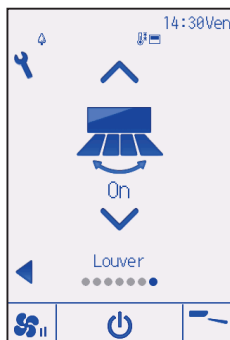

Impostazione del louver



(schermata campione su CITY MULTI)

Premere il tasto  o  per attivare o disattivare l'oscillazione del louver.



Impostazione recupero

Il recupero può essere impostato anche con le unità in funzione.

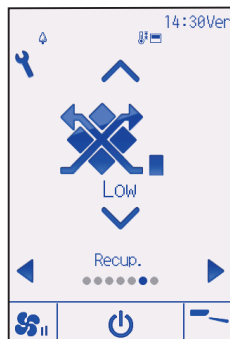

(schermata campione su Mr. SLIM)

Ad ogni pressione dei tasti  o  si scorre tra le seguenti impostazioni di recupero.

* Configurabile solo quando l'unità Lossnay è collegata.



• Il ventilatore su alcuni modelli di unità interna può essere asservito con alcuni modelli di unità di recupero.

Navigazione all'interno del menu

Elenco Menu principale

Menu principale	Voci di impostazione		Dettagli impostazione	Pagina
Operazione	High Power		Utilizzata per ottenere velocemente la temperatura ambiente desiderata. * Le unità possono essere azionate in modalità High Power non oltre i 30 minuti.	25
	Comfort	Angolo deflettore manuale	Utilizzata per impostare ciascuna inclinazione del deflettore.	26
Timer	Timer	On/Off Timer	Utilizzata per impostare i tempi di accensione/ spegnimento (On/Off). * L'orario può essere impostato con incrementi di 5 minuti. * Impostazione orologio richiesta.	29
		Timer Auto-Off	Utilizzato per impostare l'orario di autospegnimento (Auto-Off). * L'orario può essere impostato con un valore da 30 a 240 minuti con incrementi di 10 minuti.	32
	Timer settimanale		Utilizzato per impostare i tempi di accensione/ spegnimento settimanali (On/Off). * Sono disponibili fino a otto modelli operativi per giorno. * È possibile impostare due tipi di programma settimanale. * Impostazione orologio richiesta. * Non valido quando On/Off Timer è attivo. * Incrementi di 1°C	34
	Modo silenzioso Unità Esterna		Utilizzata per impostare i periodi di tempo in cui viene data priorità al funzionamento silenzioso delle unità esterne rispetto al controllo della temperatura. Impostare i tempi di Inizio/Fine per ogni giorno della settimana. * Selezionare il livello di silenziosità desiderato tra "Norm," "Medio," e "Silenzioso". * Impostazione orologio richiesta.	37
	Riduzione notturna		Utilizzata per impostare la riduzione notturna. * Selezionare "Sì" per abilitare l'impostazione e "No" per disabilitarla. Possono essere impostati il range di temperatura e i tempi di inizio/fine. * Impostazione orologio richiesta. * Incrementi di 1°C	40
Risparmio energia	Restrizioni	Range temperatura	Utilizzata per limitare il range della temperatura preimpostato. * Possono essere impostati range di temperatura differenti secondo le diverse modalità operative. * Incrementi di 1°C	43
		Operazioni proibite	Utilizzato per bloccare le funzioni selezionate. * Le funzioni bloccate non possono essere azionate.	46
	Risparmio energia	Ripristino Automatico	Utilizzata per far sì che le unità operino alla temperatura preimpostata dopo aver funzionato in modalità Risparmio energia per un periodo di tempo specificato. * L'orario può essere impostato ad un valore da 30 a 120 minuti con incrementi di 10 minuti. * Questa funzione non è valida quando i range di temperatura preimpostati sono limitati. * Incrementi di 1°C	49

Menu principale	Voci di impostazione		Dettagli impostazione	Pagina
Risparmio energia	Risparmio energia	Programma	<p>Imposta gli orari di inizio/fine per azionare le unità in modalità Risparmio energia per ogni giorno della settimana e impostare l'intervallo di risparmio energetico.</p> <ul style="list-style-type: none"> • Sono disponibili fino a quattro modelli operativi di risparmio energetico per giorno. • L'orario può essere impostato con incrementi di 5 minuti. • L'intervallo di risparmio energetico può essere impostato ad un valore da 0% e 50% a 90% con incrementi del 10%. <p>* Impostazione orologio richiesta.</p>	51
Impostazioni iniziali	Impostazione di base	Orologio	Utilizzata per impostare l'ora corrente.	54
		Ora legale	Imposta l'ora legale.	56
	Impostazione display	Display principale	Utilizzata per passare tra le modalità "Completo" e "Base" per il Display Stato e il Display principale.	58
		Luminosità	Utilizzata per regolare la luminosità dello schermo.	61
		Selezione lingua	Utilizzata per selezionare la lingua desiderata.	62
		Design	Utilizzata per modificare il colore del Display Stato e del Display principale.	64
	Schermo tattile	Calibrazione schermo tattile	Definisce le impostazioni di calibrazione per lo schermo tattile.	66
		Pulizia dello schermo tattile	Rende lo schermo temporaneamente insensibile al tatto per consentirne la pulizia.	68
Servizio tecnico	Reset controllo remoto		Utilizzata per il reset del controllo remoto alle impostazioni di fabbrica.	70
	Informazioni controllo remoto		Utilizzata per visualizzare il nome del modello del controllo remoto, la versione software e il numero seriale.	72
Manutenzione	Informazione errore		<p>Utilizzata per controllare le informazioni errore quando si verifica un errore.</p> <ul style="list-style-type: none"> • Possono essere visualizzati codice errore, sorgente errore, indirizzo refrigerante, modello unità, numero di produzione, informazioni di contatto (numero telefonico del rivenditore). <p>* Modello unità, numero di produzione, informazioni di contatto devono essere registrati in precedenza per poter essere visualizzati.</p>	74
	Informazione filtro aria		<p>Utilizzata per controllare lo stato del filtro.</p> <p>* È possibile eseguire il reset della segnalazione del filtro.</p>	78

Navigazione all'interno del menu

Navigazione all'interno del Menu principale

Tasto di funzionamento

Accesso al Menu principale



Premere il tasto **[Impostazione]** sul Display principale.

Appare il Menu principale.

Selezione voce



Premere **[F2]** per spostare il cursore a sinistra.

Premere **[F3]** per spostare il cursore a destra.

Cursore

Impostazioni funzione

High Power



Descrizione funzione

La funzione operativa High Power permette alle unità di operare a capacità superiore al normale in modo che l'aria ambiente possa essere condizionata a una temperatura ottimale velocemente. Questa operazione durerà al massimo 30 minuti, quindi l'unità tornerà alla modalità operativa normale al termine dei 30 minuti o quando la temperatura ambiente raggiunge la temperatura preimpostata, se questo avviene prima. Le unità torneranno al funzionamento normale quando la modalità operativa o la velocità del ventilatore viene cambiata.

Tasto di funzionamento

1



Selezionare "High Power" dal Menu Operazione durante le operazioni di Raffreddamento, Riscaldamento o Auto e premere il tasto **[SCEGLI]**.

La funzione "High Power" è disponibile solo sui modelli che supportano tale funzione.

2



Muovere il cursore su "Si" con il tasto **[F3]** o **[F4]** e premere il tasto **[SCEGLI]**.

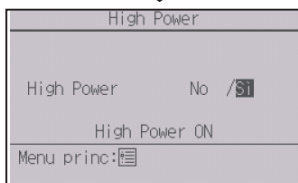

Viene visualizzata una schermata di conferma.

Navigazione all'interno delle schermate

- Per tornare al Menu principale tasto **[MENU]**
- Per tornare alla schermata precedente tasto **[INDIETRO]**

Impostazioni funzione

Angolo deflettore manuale

OFF

Tasto di funzionamento

1



Selezionare “Comfort” dal Menu Operazione e premere il tasto **[SCEGLI]**.

2

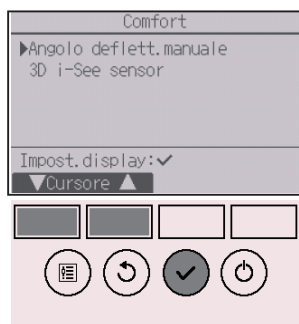

Selezionare “Angolo deflett.manuale” con il tasto **[F1]** o **[F2]** e premere il tasto **[SCEGLI]**.

3



Muovere il cursore su “Indiriz. Refr” o “No. Unità” con il tasto **[F1]** per selezionare.

Selezionare l’indirizzo del refrigerante e il numero dell’unità per le unità i cui deflettori non sono fissati con il tasto **[F2]** o **[F3]**, quindi premere il tasto **[SCEGLI]**.

- Indirizzo refrigerante: Indirizzo refrigerante
- No. Unità: 1, 2, 3, 4

Premere il tasto **[F4]** per confermare l’unità.

La schermata a sinistra mostra un display campione su Mr. SLIM. Sulle unità CITY MULTI, viene visualizzato “Indir. M-NET” invece di “Indiriz. Refr” e non viene visualizzato “No. Unità”.

4



Selezionare “Deflett.” con il tasto **[F1]**.

Selezionare “4 vie” o “2 vie” con il tasto **[F2]** o **[F3]** e premere il tasto **[F4]**.

Impostazioni funzione

5



Appare l'impostazione corrente del deflettore.

Selezionare le uscite desiderate tra "1", "2", "3", "4" o "1, 2, 3, 4 (tutte le uscite)" con il tasto **[F1]** o **[F2]**.

Premere il tasto **[F3]** o **[F4]** per scorrere le seguenti opzioni e selezionare l'impostazione desiderata.

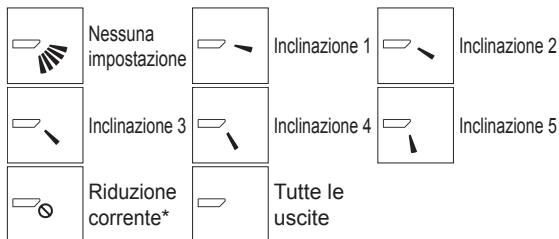

Premere il tasto **[SCEGLI]** per salvare le impostazioni. Appare una schermata a indicare che le informazioni di impostazione sono state trasmesse.

Le modifiche di impostazione verranno fatte all'uscita selezionata.

La schermata tornerà automaticamente a quella precedente al termine della trasmissione.

Eeguire le impostazioni per le altre uscite, seguendo la stessa procedura.

Se tutte le uscite sono selezionate,  verrà visualizzato la volta successiva in cui l'unità entra in funzione.

Navigazione all'interno delle schermate

• Per tornare alla schermata precedente tasto **[INDIETRO]**

*Riduzione corrente

La modalità [Riduzione corrente] mantiene l'inclinazione del deflettore in posizione più orizzontale rispetto a quella dell'Inclinazione 1, in modo che il flusso dell'aria non sia orientato verso le persone.

Questa funzione può essere impostata per una sola uscita.

Questa funzione non può essere impostata nei modelli con due o tre uscite.

In modalità Riduzione corrente, il flusso dell'aria potrebbe causare lo scolorimento del soffitto.

Tasto di funzionamento

1



Selezionare “Timer” dal Menu principale (consultare pagina 24) e premere il tasto **SCEGLI**.

L'On/Off Timer non funziona nei seguenti casi:

quando On/Off Timer è disabilitato, durante un errore, un controllo (nel Menu di servizio), l'esecuzione di una prova di funzionamento, la diagnosi del controllo remoto, quando l'orologio non è impostato, durante l'impostazione delle funzioni, quando il sistema è controllato in maniera centrale (quando l'operazione “On/Off” o l'operazione “Timer” dal controllo remoto locale non è consentita).

2



Muovere il cursore su “Timer” e premere il tasto **SCEGLI**.

3



Appare l'impostazione corrente.

Muovere il cursore su “On/Off Timer” e premere il tasto **SCEGLI**.

Impostazioni funzione

4



Appare la schermata di impostazione del timer.

Selezionare la voce desiderata con il tasto **F1** o **F2** tra “On/Off Timer”, “On”, “Off”, o “Ripetiz”.

5



Cambiare l'impostazione con il tasto **F3** o **F4**.

- On/Off Timer: No (disabilita)/Si (abilita)
- On: Orario inizio operazione
(configurabile con incrementi di 5 minuti)
* Tenere premuto il tasto per avanzare rapidamente.
- Off: Orario fine operazione
(configurabile con incrementi di 5 minuti)
* Tenere premuto il tasto per avanzare rapidamente.
- Ripetiz: No (una volta)/Si (ripeti)

6



Premere il tasto **[SCEGLI]** per salvare le impostazioni.





Viene visualizzata una schermata di conferma.

Navigazione all'interno delle schermate

- Per tornare al Menu principale tasto **[MENU]**
- Per tornare alla schermata precedente tasto **[INDIETRO]**



 appare sul Display Stato e sul display Principale in modalità Completo quando On/Off Timer è abilitato.

 appare quando il timer viene disabilitato dal sistema di controllo centralizzato.

Impostazioni funzione

Timer (Timer Auto-Off)



Tasto di funzionamento

1



Attivare la schermata impostazione Timer.
(consultare pagina 29).

Selezionare “Auto-Off” e premere il tasto **[SCEGLI]**.

Il Timer Auto-Off non funziona nei seguenti casi:
quando il timer Auto-Off viene disabilitato, durante un errore, un controllo (nel Menu di servizio), l'esecuzione di una prova di funzionamento, la diagnosi del controllo remoto, durante l'impostazione delle funzioni, quando il sistema è controllato in maniera centrale (quando l'operazione On/Off o l'operazione Timer dal controllo remoto locale non è consentita).

2



Appare l'impostazione corrente.

Muovere il cursore “Auto-Off” o “Spegnim. tra --- minuti” con il tasto **[F1]** o **[F2]**.

3



Cambiare l'impostazione con il tasto **[F3]** o **[F4]**.

- Auto-Off: No (disabilita)/Si (abilita)
- Spegnim. tra --- minuti: Impostazione del timer (l'intervallo configurabile è compreso tra 30 e 240 minuti con incrementi di 10 minuti).

4



Premere il tasto **SCEGLI** per salvare le impostazioni.





Viene visualizzata una schermata di conferma.

Navigazione all'interno delle schermate

- Per tornare al Menu principale tasto **MENU**
- Per tornare alla schermata precedente tasto **INDIETRO**



 appare sul Display Stato e sul display Principale in modalità Completo quando Timer Auto-Off è abilitato.

 appare quando il timer viene disabilitato dal sistema di controllo centralizzato.

Impostazioni funzione

Timer settimanale



Tasto di funzionamento

1



Selezionare “Timer settimanale” dal Menu Timer e premere il tasto **[SCEGLI]**.

Il Timer settimanale non funziona nei seguenti casi:

quando On/Off Timer è abilitato, quando il timer settimanale è disabilitato, durante un errore, un controllo (nel Menu di servizio), l'esecuzione di una prova di funzionamento, la diagnosi del controllo remoto, quando l'orologio non è impostato, durante l'impostazione delle funzioni, quando il sistema è controllato in maniera centrale (l'operazione On/Off, l'impostazione della temperatura o l'operazione timer dal controllo remoto locale non sono consentite).

2



Appare l'impostazione corrente.

Premere il tasto **[F1]** o **[F2]** per vedere le impostazioni per ogni giorno della settimana.

Premere il tasto **[F3]** per vedere le configurazioni da 5 a 8.

Premere il tasto **[F4]** per visualizzare lo stato dell'Impostazione 2.

Premere il tasto **[SCEGLI]** per andare alla schermata impostazione.

3



Appare la schermata delle impostazioni del timer settimanale.

Nell'impostazione "Azione" selezionare "1" per abilitare l'impostazione 1 del timer oppure selezionare "2" per abilitare l'impostazione 2 del timer con il tasto **F3** o **F4**. Quindi premere il tasto **SCEGLI**.

Per verificare i valori di impostazione del timer 1 o 2, spostare il cursore su "Impostazione" con il tasto **F1** o **F2** e selezionare "1" o "2" con il tasto **F3** o **F4**.

4



Appare la schermata delle impostazioni del timer settimanale e vengono visualizzate le impostazioni correnti.

Sono disponibili fino a otto modelli operativi per giorno.

Muovere il cursore al giorno desiderato con il tasto **F1** o **F2** e premere il tasto **F3** per selezionare. (è possibile selezionare più giorni).

Premere il tasto **SCEGLI**.

Impostazioni funzione

5

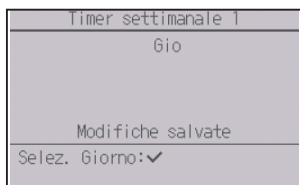

Appare la schermata di impostazione modello operativo.

Premere il tasto **[F1]** per spostare il cursore al numero del modello desiderato.

Spostare il cursore su ora, On/Off o temperatura con il tasto **[F2]**.

Cambiare le impostazioni con il tasto **[F3]** o **[F4]**.

- Ora: configurabile con incrementi di 5 minuti
* Tenere premuto il tasto per avanzare rapidamente.
- On/Off/Auto: Le impostazioni selezionabili dipendono dal modello di unità interna collegata. (Quando il modello Auto viene eseguito, il sistema funzionerà in modo Auto (impostazione punto doppio).)
- Temperatura: Il range di temperatura configurabile varia in base alle unità interne collegate. (incrementi di 1°C)
Quando viene selezionato il modo Auto (impostazione punto doppio), possono essere impostate due temperature preimpostate. Se un modello operativo con un'impostazione singola di temperature preimpostate viene eseguito in modo "Auto" (impostazione punto doppio), la sua impostazione sarà utilizzata come impostazione temperatura di raffreddamento in modo "Raffreddamento".

Premere il tasto **[SCEGLI]** per salvare le impostazioni.

Viene visualizzata una schermata di conferma.

Navigazione all'interno delle schermate

- Per tornare alla schermata di modifica impostazione/ selezione giorno della settimana tasto **[SCEGLI]**
- Per tornare al Menu principale tasto **[MENU]**
- Per tornare alla schermata precedente tasto **[INDIETRO]**



 appare sul Display Stato e sul display Principale in modalità Completo quando è presente l'impostazione del Timer settimanale per il giorno corrente.

L'icona non apparirà mentre On/Off timer è abilitato o il sistema è sotto controllo centralizzato (l'operazione timer dal controllo remoto locale non è consentita).

Descrizione funzione

Questa funzione consente all'utente di impostare i periodi di tempo in cui viene data priorità al funzionamento silenzioso delle unità esterne rispetto al controllo della temperatura. Impostare l'ora di avvio e arresto della modalità silenziosa per ogni giorno della settimana. Selezionare il livello di silenziosità desiderato tra "Medio" e "Silenzioso".

Tasto di funzionamento

1



Selezionare "Modo silenzioso Unità Est." dal Menu Timer e premere il tasto **[SCEGLI]**.

La funzione "Modo silenzioso Unità Est." è disponibile solo sui modelli che supportano tale funzione.

2



Appare l'impostazione corrente.

Premere il tasto **[F1]** o **[F2]** per vedere le impostazioni per ogni giorno della settimana.

Premere il tasto **[SCEGLI]** per andare alla schermata impostazione.

Impostazioni funzione

3

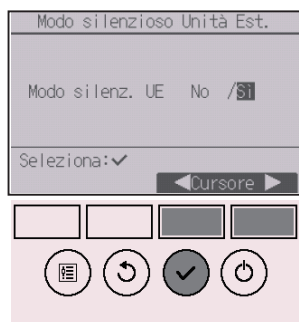

Appare la schermata per abilitare (Si) o disabilitare (No) la modalità silenziosa.

Per abilitare questa funzione, muovere il cursore su "Si" con il tasto **[F3]** o **[F4]** e premere il tasto **[SCEGLI]**.

4



Appare la schermata Modo silenzioso Unità Esterna.

Muovere il cursore al giorno della settimana desiderato con il tasto **[F1]** o **[F2]** e premere il tasto **[F3]** per selezionare o modificare la selezione. (è possibile selezionare più giorni.)

Premere il tasto **[SCEGLI]**.

5

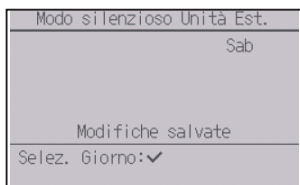

Appare la schermata impostazione.

Spostare il cursore sulla voce desiderata fra Ora inizio, Ora fine o Livello silenziosità con il tasto **[F1]** o **[F2]**.

Cambiare le impostazioni con il tasto **[F3]** o **[F4]**.

- Ora Inizio/Fine: configurabile con incrementi di 5 minuti
* Tenere premuto il tasto per avanzare rapidamente.
- Livello silenziosità: Normale, Medio, Silenzioso



Premere il tasto **[SCEGLI]** per salvare le impostazioni. Viene visualizzata una schermata di conferma.

Navigazione all'interno delle schermate

- Per tornare alla schermata di modifica impostazione/ selezione giorno della settimana tasto **[SCEGLI]**
- Per tornare al Menu principale tasto **[MENU]**
- Per tornare alla schermata precedente tasto **[INDIETRO]**

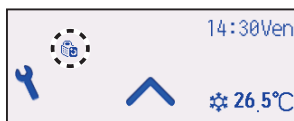

appare sul Display Stato e sul display Principale in modalità Completo durante il modo silenzioso Unità esterna.

Impostazioni funzione

Riduzione notturna



Descrizione funzione

Questo comando avvia l'operazione di riscaldamento quando il gruppo oggetto controllo è arrestato e la temperatura ambiente scende sotto il limite inferiore di temperatura preimpostato. Inoltre, questo comando avvia l'operazione di raffreddamento quando il gruppo oggetto controllo è arrestato e la temperatura ambiente sale sopra il limite superiore di temperatura preimpostato.

La funzione Riduzione notturna non è disponibile se l'operazione e l'impostazione della temperatura sono eseguite dal controllo remoto.

La temperatura ambiente, se misurata dal sensore della temperatura di aspirazione del climatizzatore, potrebbe non essere registrata correttamente se il climatizzatore non è attivo e l'aria non è pulita. In questo caso, passare al sensore remoto (PAC-SE40TSA/PAC-SE41TS-E) o a un sensore di controllo remoto.

Tasto di funzionamento

1



Selezionare "Riduzione notturna" dal Menu Timer e premere il tasto **SCEGLI**.

2

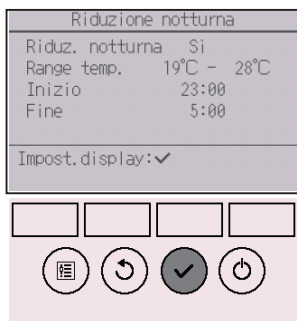

Appare l'impostazione corrente.

Premere il tasto **SCEGLI** per andare alla schermata impostazione.

3

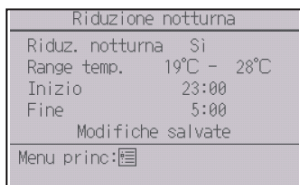

Spostare il cursore sulla voce desiderata tra Riduzione notturna No (disabilita)/Si (abilita), Range temperatura, Ora inizio o Ora fine con il tasto **F1** o **F2**.

Cambiare le impostazioni con il tasto **F3** o **F4**.

- Range temp.: Può essere impostato il limite di temperatura inferiore (per l'operazione di riscaldamento) e il limite temperatura superiore (per l'operazione di raffreddamento). La differenza di temperatura tra i limiti superiore e inferiore deve essere 4°C (8°F) o superiore. Il range di temperatura configurabile varia in base alle unità interne collegate.
 - * Incrementi di 1°C
- Ora Inizio/Fine: configurabile con incrementi di 5 minuti
 - * Tenere premuto il tasto per avanzare rapidamente.

Premere il tasto **SCEGLI** per salvare le impostazioni. Viene visualizzata una schermata di conferma.

Navigazione all'interno delle schermate

- Per tornare al Menu principale tasto **MENU**
- Per tornare alla schermata precedente tasto **INDIETRO**

Impostazioni funzione



 appare sul Display Stato e sul display Principale in modalità Completo quando la funzione Riduzione notturna è abilitata.

 appare quando il timer viene disabilitato dal sistema di controllo centralizzato.

La Riduzione notturna non funziona nei seguenti casi:

quando l'unità è operativa, quando la Riduzione notturna è disabilitata, durante un errore, un controllo (nel Menu di servizio), l'esecuzione di una prova di funzionamento, la diagnosi del controllo remoto, quando l'orologio non è impostato, durante l'impostazione delle funzioni, quando il sistema è controllato in maniera centrale (l'operazione On/Off, l'impostazione della temperatura o l'operazione timer dal controllo remoto locale non sono consentite).

Impostare la limitazione del range di temperatura

Tasto di funzionamento

1



Selezionare “Risparmio energia” dal Menu principale (consultare pagina 24) e premere il tasto **SCEGLI**.

2



Muovere il cursore su “Restrizioni” con il tasto **F1** o **F2** e premere il tasto **SCEGLI**.

Impostazioni funzione

3



Appare l'impostazione corrente.

Muovere il cursore su "Range temp." con il tasto **F1** o **F2** e premere il tasto **SCEGLI**.

4

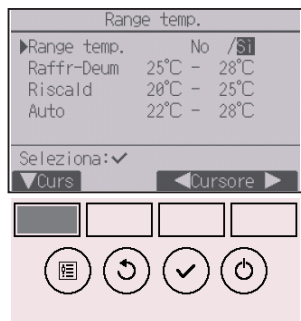

Appare la schermata per impostare l'intervallo di temperatura.

Con il tasto **F1** spostare il cursore sulla voce desiderata tra "Range temp.", "Raffr-Deum", "Riscald" o "Auto".

5

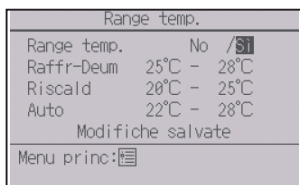

Cambiare le impostazioni con il tasto [F3] o [F4].

- Range temp.: No (illimitato) o Si (limitato)
- Raffr-Deum: Limite di temperatura superiore e inferiore (incrementi di 1°C)
- Riscald: Limite di temperatura superiore e inferiore (incrementi di 1°C)
- Auto: Limite di temperatura superiore e inferiore (incrementi di 1°C)

Intervalli impostazione temperatura

Modalità		Limite inferiore	Limite superiore
Raffr-Deum	*1 *3	19 ~ 30°C (67 ~ 87°F)	30 ~ 19°C (87 ~ 67°F)
Riscaldamento	*2 *3	17 ~ 28°C (63 ~ 83°F)	28 ~ 17°C (83 ~ 63°F)
Auto	*4	19 ~ 28°C (67 ~ 83°F)	28 ~ 19°C (83 ~ 67°F)

* L'intervallo configurabile varia secondo l'unità collegata.

*1 Possono essere impostati range di temperatura per le modalità Raffreddamento, Deumidificatore e Auto (impostazione punto doppio).

*2 Possono essere impostati range di temperatura per le modalità Riscaldamento e Auto (impostazione punto doppio).

*3 I range di temperatura per le modalità Riscaldamento, Raffreddamento e Deumidificatore devono soddisfare le seguenti condizioni:

- Limite superiore per il raffreddamento - limite superiore per il riscaldamento \geq Differenza temperatura minima (varia in base al modello dell'unità interna)
- Limite inferiore per il raffreddamento - limite inferiore per il riscaldamento \geq Differenza temperatura minima (varia in base al modello dell'unità interna)

*4 Può essere impostato il range di temperatura per il modo Auto (impostazione punto singolo).

Premere il tasto [SCEGLI] per salvare le impostazioni. Viene visualizzata una schermata di conferma.

Navigazione all'interno delle schermate

- Per tornare al Menu principale tasto [MENU]
- Per tornare alla schermata precedente tasto [INDIETRO]



 appare sul Display Stato e sul display Principale in modalità Completo quando il range di temperatura è limitato.

Impostazioni funzione

Restrizioni



Funzione Operazioni proibite

Tasto di funzionamento

Per abilitare la funzione Operazioni proibite, impostare la voce "Operaz. proibite" su "Sì".

1



Attivare la schermata impostazione Restrizioni. (consultare pagina 43).

Muovere il cursore su "Operaz. proibite" e premere il tasto **[SCEGLI]**.

2

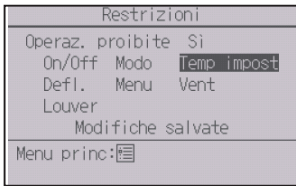

Appare la schermata per le impostazioni della funzione Operazioni proibite.

Con il tasto **F1** o **F2** spostare il cursore sulla voce desiderata tra “Operaz. proibite”, “Ambiente”, “On/Off”, “Modo”, “Temp impost”, “Menu”, “Vent”, “ Louver” o “Defl.”.

Cambiare le impostazioni con il tasto **F3** o **F4**.

- Operaz. proibite: No (disabilita)/Sì (abilita)
- Ambiente: “Indiv.” o “Hotel”
- On/Off: Operazione On/Off
- Modo: Impostazione modalità operativa
- Temp impost: Impostazione temperatura preimpostata
- Defl.: Impostazione del deflettore
- Menu: Impostazione menu
- Vent: Impostazione velocità ventilatore
- Louver: Impostazione del louver

“-” / “Bloccato”

Quando viene selezionato “Hotel” come impostazione “Ambiente”, le seguenti operazioni verranno automaticamente bloccate: Modo, Deflettore, Menu e Louver.

Premere il tasto **SCEGLI** per salvare le impostazioni. Viene visualizzata una schermata di conferma.

Navigazione all’interno delle schermate

- Per tornare al Menu principale tasto **MENU**
- Per tornare alla schermata precedente tasto **INDIETRO**

Impostazioni funzione



 appare sul Display Stato e sul display Principale in modalità Completo quando l'impostazione funzione Operazioni proibite è abilitata.

La guida operativa che corrisponde alla funzione bloccata verrà impedita.

Per visualizzare il menu principale se l'impostazione del menu è bloccata, tenere premuto il tasto Impostazione per dieci o più secondi. Immettere la password amministratore nella schermata di inserimento password.

Ritorno automatico alla temperatura preimpostata

Dopo aver abilitato la funzione Ripristino Automatico, se viene modificata la modalità operativa o viene eseguita l'operazione ON/OFF tramite questo controllo remoto, la temperatura impostata torna automaticamente a quella richiesta indipendentemente dall'orario impostato.

Tasto di funzionamento

1



Selezionare "Risparmio energia" di menu Risparmio energia, quindi premere il tasto **[SCEGLI]**.

2



Appare l'impostazione corrente.

Muovere il cursore su "Riprist. Autom." con il tasto **[F1]** o **[F2]** e premere il tasto **[SCEGLI]**.

Impostazioni funzione

3



Appare la schermata delle impostazioni per il ripristino automatico alla temperatura preimpostata.

Spostare il cursore sulla voce desiderata fra “Riprist. Autom.”, “Raffr” o “Risc” con il tasto [F1] o [F2].

4



Cambiare le impostazioni con il tasto [F3] o [F4].

- Riprist. Autom.: No (disabilita)/Si (abilita)
- Raffr: Il range di impostazione del timer è compreso tra 30 e 120 minuti con incrementi di 10 minuti.
Il range di impostazione della temperatura è compreso tra 19 e 30°C (tra 67 e 87°F). (incrementi di 1°C).
- Risc: Il range di impostazione del timer è compreso tra 30 e 120 minuti con incrementi di 10 minuti.
Il range di impostazione della temperatura è compreso tra 17 e 28°C (tra 63 e 83°F). (incrementi di 1°C).

Premere il tasto [SCEGLI] per salvare le impostazioni. “Raffr” include le modalità “Deumid” e “Auto Raffred” e “Risc” include la modalità “Auto Riscald”.

Appare la schermata per impostare la voce selezionata.



Navigazione all'interno delle schermate

- Per tornare al Menu principale tasto [MENU]
- Per tornare alla schermata precedente tasto [INDIETRO]

Le impostazioni della temperatura preimpostata o del timer non saranno effettive quando il range della temperatura viene limitato e quando il sistema è controllato in maniera centrale (quando l'impostazione del range della temperatura dal controllo locale non è consentita). Quando il sistema è controllato in maniera centrale (quando l'operazione timer dal controllo remoto locale non è consentita), solo l'impostazione timer non sarà effettiva.

Impostazione del programma operativo Risparmio energia

Tasto di funzionamento

1



Attivare la schermata "Risparmio energia".
(consultare pagina 49).

Muovere il cursore su "Programma" e premere il tasto **SCEGLI**.

2



Appare la schermata con il programma.

Premere il tasto **F1** o **F2** per vedere le impostazioni per ogni giorno della settimana.

Premere il tasto **SCEGLI** per andare alla schermata impostazione.

3



Appare la schermata per abilitare (Si) o disabilitare (No) il programma operativo Risparmio energia.

Selezionare "No" o "Si" con il tasto **F3** o **F4**.

Premere il tasto **SCEGLI** per tornare alla schermata di modifica impostazione/selezione giorno della settimana.

Impostazioni funzione

4



Appare la schermata di modifica impostazione/ selezione giorno della settimana.

Sono disponibili fino a quattro modelli operativi per giorno.

Muovere il cursore al giorno desiderato con il tasto **F1** o **F2** e premere il tasto **F3** per selezionare. (è possibile selezionare più giorni.)

Premere il tasto **[SCEGLI]** per andare alla schermata di impostazione modello.

5



Appare la schermata di impostazione modello.

Premere il tasto **F1** per spostare il cursore al numero del modello desiderato.

Con il tasto **F2** spostare il cursore sulla voce desiderata fra ora inizio, ora fine o intervallo di risparmio energetico (in questo stesso ordine da sinistra).

Cambiare le impostazioni con il tasto **F3** o **F4**.

- Ora Inizio/Fine: configurabile con incrementi di 5 minuti
- * Tenere premuto il tasto per avanzare rapidamente.

- Intervallo di risparmio energetico: L'intervallo di impostazione va da 0% e 50 a 90% con incrementi del 10%.

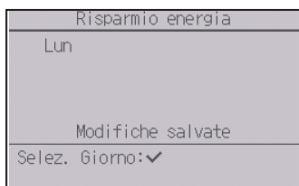

Premere il tasto **[SCEGLI]** per salvare le impostazioni. Viene visualizzata una schermata di conferma.

Quanto inferiore è il valore, tanto maggiore sarà il risparmio energetico.



 appare sul Display Stato e sul display Principale in modalità Completo quando l'unità è azionata in modo Risparmio energia.

Navigazione all'interno delle schermate

- Per tornare alla schermata di modifica impostazione/
selezione giorno della settimana tasto **SCEGLI**
- Per tornare al Menu principale tasto **MENU**
- Per tornare alla schermata precedente tasto **INDIETRO**

Impostazioni funzione

Orologio



Tasto di funzionamento

1



Selezionare “Impostazioni iniziali” dal Menu principale (consultare pagina 24) e premere il tasto **[SCEGLI]**.

Impostazione orologio richiesta prima di eseguire queste impostazioni.

- On/Off Timer
- Timer settimanale
- Modo silenzioso Unità Esterna
- Risparmio energia
- Riduzione notturna

Se un determinato sistema non è dotato di controller di sistema, l'orologio non viene regolato automaticamente.

In questo caso, correggere periodicamente l'ora.

2



Muovere il cursore su “Impostazione di base” con il tasto **[F1]** o **[F2]** e premere il tasto **[SCEGLI]**.

3



Selezionare “Orologio” con il tasto **[F1]** o **[F2]** e premere il tasto **[SCEGLI]**.

4



Muovere il cursore su “Orologio” con il tasto **F1** o **F2** e premere il tasto **SCEGLI**.

5



Spostare il cursore sulla voce desiderata fra anno, mese, data, ora o minuto con il tasto **F1** o **F2**. Aumentare o diminuire il valore della voce selezionata con il tasto **F3** o **F4** e premere il tasto **SCEGLI**.

Viene visualizzata una schermata di conferma.

Navigazione all'interno delle schermate

- Per tornare al Menu principale tasto **MENU**
- Per tornare alla schermata precedente tasto **INDIETRO**

Impostazioni funzione

Ora legale



Descrizione funzione

È possibile impostare l'ora di inizio/fine dell'ora legale. La funzione ora legale viene attivata in base ai valori di impostazione.

- Se un determinato sistema è dotato di controller di sistema, disabilitare questa impostazione per mantenere l'ora corretta.
- All'inizio e alla fine dell'ora legale, il timer potrebbe entrare in funzione due volte o nessuna.
- Questa funzione non è operativa se l'orologio non è impostato.

Tasto di funzionamento

1



Selezionare “Orologio” dal menu Impostazione di base, quindi premere il tasto **[SCEGLI]**.

2



Muovere il cursore su “Ora legale” con il tasto **[F1]** o **[F2]** e premere il tasto **[SCEGLI]**.

3

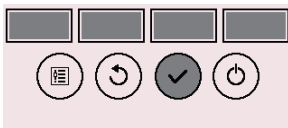
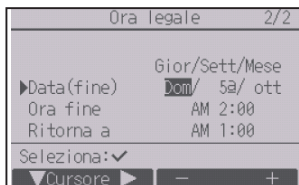
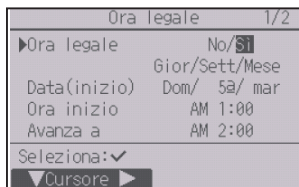

Spostare il cursore sulle voci successive con il tasto **[F1]** per configurare le impostazioni.

- Ora legale
Selezionare "No" (disabilita) o "Sì" (abilita) con il tasto **[F2]**.
L'impostazione predefinita è "No".
 - Data(inizio)*1
Impostare il giorno della settimana, il numero di settimana e il mese con il tasto **[F3]** o **[F4]**. L'impostazione predefinita è "Dom/5^a/mar".
 - Ora inizio
Impostare l'ora di inizio dell'ora legale con il tasto **[F3]** o **[F4]**.
 - Avanza a
Impostare l'ora alla quale spostare avanti l'orologio dall'ora iniziale indicata sopra con il tasto **[F3]** o **[F4]**.
 - Data(fine)*1 (2a pagina)
Impostare il giorno della settimana, il numero di settimana e il mese con il tasto **[F3]** o **[F4]**. L'impostazione predefinita è "Dom/5^a/ott".
 - Ora fine (2a pagina)
Impostare l'ora di fine dell'ora legale con il tasto **[F3]** o **[F4]**.
 - Ritorna a (2a pagina)
Impostare l'ora alla quale spostare indietro l'orologio dall'ora di fine indicata sopra con il tasto **[F3]** o **[F4]**.
- *1 Se si seleziona "5^a" come numero di settimana, ma la 5^a settimana non esiste nel mese selezionato, l'impostazione valida sarà "4^a".

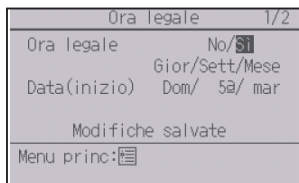

Premere il tasto **[SCEGLI]** per salvare le impostazioni. Viene visualizzata una schermata di conferma.

Navigazione all'interno delle schermate

- Per tornare al Menu principale tasto **[MENU]**
- Per tornare alla schermata precedente tasto **[INDIETRO]**

Impostazioni funzione

Imposta display principale



Tasto di funzionamento

1



Selezionare “Impostazione display” dal Menu impostazioni iniziali e premere il tasto **[SCEGLI]**.

2



Muovere il cursore su “Imposta display principale” con il tasto **[F1]** o **[F2]** e premere il tasto **[SCEGLI]**.

3



Selezionare “Completo” o “Base” (consultare pagina 10) con il tasto **[F3]** o **[F4]** e premere il tasto **[SCEGLI]**.

Viene visualizzata una schermata di conferma.

Navigazione all'interno delle schermate

- Per tornare al Menu principale tasto **[MENU]**
- Per tornare alla schermata precedente tasto **[INDIETRO]**

Tasto di funzionamento

1

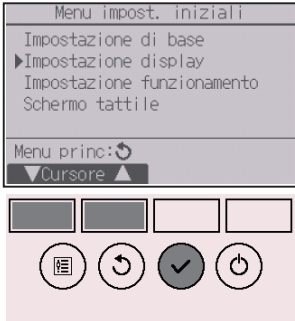

Selezionare “Impostazione display” dal Menu impostazioni iniziali e premere il tasto **[SCEGLI]**.

2



Muovere il cursore su “Imposta display principale” con il tasto **[F1]** o **[F2]** e premere il tasto **[SCEGLI]**.

3



Selezionare “Spiegaz. icone” con il tasto **[F1]** o **[F2]**, selezionare l'impostazione desiderata “Si” o “No” con il tasto **[F3]** o **[F4]**, quindi premere il tasto **[SCEGLI]**. L'impostazione predefinita è “Si”.

Navigazione all'interno delle schermate

- Per tornare al Menu principale tasto **[MENU]**
- Per tornare alla schermata precedente tasto **[INDIETRO]**

Impostazioni funzione

4

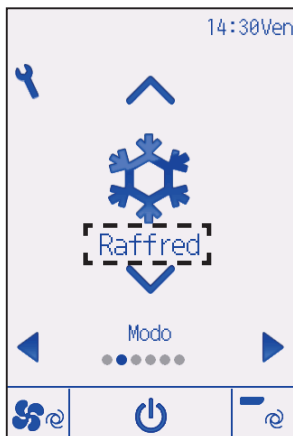

Se si seleziona "Sì", la spiegazione dell'icona della voce di impostazione verrà visualizzata a sinistra.

Tasto di funzionamento

1



Selezionare “Impostazione display” dal Menu impostazioni iniziali e premere il tasto **[SCEGLI]**.

2



Muovere il cursore su “Luminosità” con il tasto **[F1]** o **[F2]** e premere il tasto **[SCEGLI]**.

3



Regolare la luminosità con il tasto **[F1]** o **[F2]**.
È possibile selezionare “ON” o “OFF” per l’impostazione “Sempre acc” con il tasto **[F4]**.

Se è selezionato “ON” la retroilluminazione sarà attiva, pur se fioca, anche al termine del tempo specificato.

Navigazione all’interno delle schermate

- Per tornare al Menu principale tasto **[MENU]**
- Per tornare alla schermata precedente tasto **[INDIETRO]**

Impostazioni funzione

Selezione lingua



Descrizione funzione

Impostare la lingua desiderata. Le opzioni sono Inglese, Francese, Tedesco, Spagnolo, Italiano, Portoghese, Svedese, Russo, Greco, Turco, Olandese, Ceco, Ungherese e Polacco.

Tasto di funzionamento

1



Selezionare “Impostazione display” dal Menu impostazioni iniziali e premere il tasto **[SCEGLI]**.

2



Muovere il cursore su “Selezione lingua” con il tasto **[F1]** o **[F2]** e premere il tasto **[SCEGLI]**.

3



Muovere il cursore sulla lingua desiderata con i tasti da **F1** a **F4** e premere il tasto **SCEGLI** per salvare l'impostazione.

Alla prima accensione, viene visualizzata la schermata Selezione lingua. Selezionare la lingua desiderata. Se la lingua non viene selezionata, il sistema non si avvia.



Appare una schermata a indicare che l'impostazione è stata salvata.

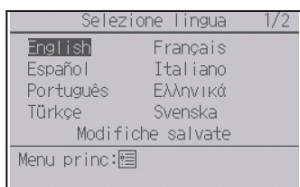

Navigazione all'interno delle schermate

- Per tornare al Menu principale tasto **MENU**
- Per tornare alla schermata precedente tasto **INDIETRO**

Impostazioni funzione

Design



Tasto di funzionamento

1



Selezionare “Impostazione display” dal Menu impostazioni iniziali e premere il tasto **[SCEGLI]**.

2



Muovere il cursore su “Design” con il tasto **[F1]** o **[F2]** e premere il tasto **[SCEGLI]**.

3



Selezionare “Colore” con il tasto **[F4]**.

- Colore: È possibile selezionare il colore del display. (Fare riferimento alla pagina successiva.)
- Bianco: Display monocromatico (sfondo bianco)
- Nero: Display monocromatico (sfondo nero)

Se viene selezionato “Bianco” o “Nero”, premere il tasto **[SCEGLI]**. Se viene selezionato “Colore”, selezionare il colore desiderato facendo riferimento alla pagina successiva.

4



Selezionare la voce seguente con il tasto **F1** o **F2**, quindi impostare il colore di display desiderato per ciascuna voce.

- Gradazione di colore: Impostare la gradazione di colore con il tasto **F3** o **F4**. (È possibile impostare valori tra -90 e 89.)
- Modello: Impostare il colore con il tasto **F4**.
- Colore ass. a: Selezionare “Carattere” o “Sfondo” come il target a cui il colore è associato con il tasto **F4**.

Il colore campione sotto i tasti funzione cambierà in base all'impostazione.

Impostare il colore desiderato e premere il tasto **SCEGLI**.

Navigazione all'interno delle schermate

- Per tornare al Menu principale tasto **MENU**
- Per tornare alla schermata precedente tasto **INDIETRO**

Impostazioni funzione

Calibrazione schermo tattile



Tasto di funzionamento

1



Selezionare “Schermo tattile” dal Menu impostazioni iniziali e premere il tasto **[SCEGLI]**.

2



Muovere il cursore su “Calibrazione schermo tattile” con il tasto **[F1]** o **[F2]** e premere il tasto **[SCEGLI]**.

3

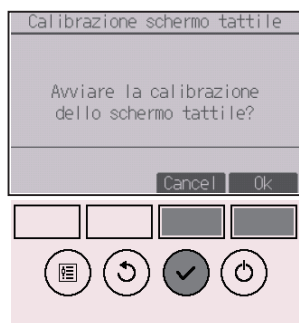

Viene visualizzata una schermata di conferma. Selezionare “Cancel” o “Ok” con il tasto **[F3]** o **[F4]** e premere il tasto **[SCEGLI]**.

4

Toccare i punti neri nell'ordine di apparizione sullo schermo. Ci saranno nove punti in totale.

Toccare i punti neri con un pennino per schermi tattili in 1 minuto, cominciando dall'angolo in alto a sinistra.

Toccare i nove punti neri nel loro ordine di apparizione sullo schermo.

Quando tutti e nove i punti neri saranno stati toccati la calibrazione sarà completa e il display tornerà al menu Schermo tattile.

- Se lo schermo tattile non viene toccato per un minuto, la calibrazione sarà annullata e il display tornerà automaticamente alla schermata precedente.
- Per una calibrazione corretta dello schermo tattile utilizzare un oggetto appuntito, ma non affilato per toccare i punti.
 - * Un oggetto affilato potrebbe danneggiare o graffiare lo schermo tattile.

Impostazioni funzione

Pulizia dello schermo tattile



Tasto di funzionamento

1



Selezionare “Schermo tattile” dal Menu impostazioni iniziali e premere il tasto **[SCEGLI]**.

2



Muovere il cursore su “Pulizia dello schermo tattile” con il tasto **[F1]** o **[F2]** e premere il tasto **[SCEGLI]**.

3

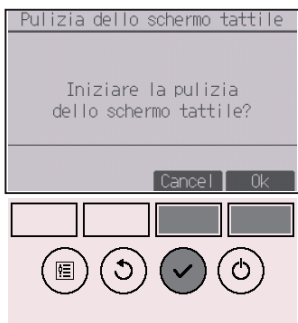

Viene visualizzata una schermata di conferma. Selezionare “Cancel” o “Ok” con il tasto **[F3]** o **[F4]** e premere il tasto **[SCEGLI]**.

4

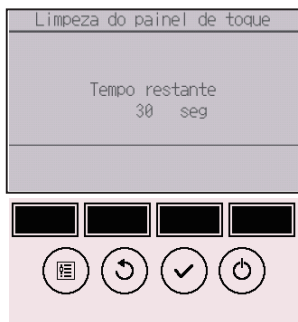

Questa schermata consente all'utente di pulire lo schermo tattile per 30 secondi senza il rischio di modificare accidentalmente le impostazioni. Il display tornerà al menu Schermo tattile dopo 30 secondi.

- Pulire lo schermo con un panno morbido e asciutto, un panno inumidito in acqua e detergente non aggressivo o un panno inumidito con etanolo. Non utilizzare solventi acidi, alcalini o organici.

Impostazioni funzione

Reset controllo remoto



Descrizione funzione

Il controllo remoto può essere inizializzato alle impostazioni di fabbrica. Si prega di notare che i dati seguenti saranno inizializzati.

Il controllo remoto verrà automaticamente avviato dopo l'inizializzazione.

Impostazione Timer, impostazione Timer settimanale, impostazione Modo silenzioso Unità Esterna, impostazione Risparmio energia, impostazione Opzione risparmio energetico, impostazione Orologio, impostazione Ora legale, impostazione Display principale, impostazione Luminosità, impostazione Dettagli display, impostazione Design, impostazione Modo Auto, impostazione Modello, impostazione Numero Seriale, impostazione Informazioni rivenditore, Informazione errore, Password amministratore, Password Tecnico

Tasto di funzionamento

1



Selezionare “Altri” dal Menu di Servizio e premere il tasto **[SCEGLI]**.

2



Muovere il cursore su “Reset controllo remoto” con il tasto **[F1]** o **[F2]** e premere il tasto **[SCEGLI]**.

3



Selezionare "Ok" con il tasto **F4**.

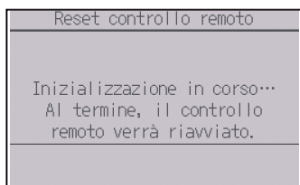

Il controllo remoto verrà automaticamente avviato dopo l'inizializzazione.

Impostazioni funzione

Informazioni controllo remoto



Descrizione funzione

È possibile verificare le informazioni relative al controllo remoto utilizzato.

Tasto di funzionamento

1



Selezionare “Altri” dal Menu di Servizio e premere il tasto **SCEGLI**.

2



Muovere il cursore su “Informazioni controllo remoto” con il tasto **F1** o **F2** e premere il tasto **SCEGLI**.

3

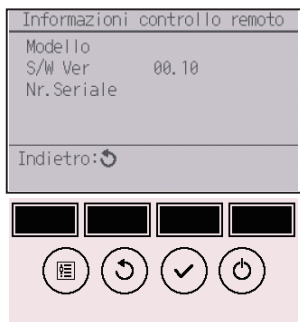

È possibile verificare il modello, la versione software e il numero seriale del controllo remoto utilizzato.

Risoluzione dei problemi

Informazione errore

Quando si verifica un errore, appare la seguente schermata e il LED di funzionamento lampeggia. Controllare lo stato dell'errore, arrestare il funzionamento e consultare il rivenditore.

Tasto di funzionamento

1



Appaiono codice errore, unità errore, indirizzo refrigerante, modello unità, data e ora in cui si è verificato l'errore e numero seriale. Il modello e il numero seriale appaiono solo se le informazioni sono state registrate.

Premere il tasto **F1** o **F2** per andare alla pagina successiva.

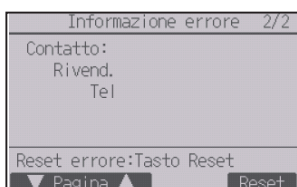

Le informazioni di contatto (numero telefonico del rivenditore) appaiono solo se queste sono state registrate.

2

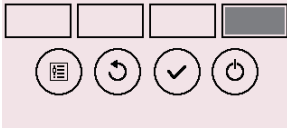
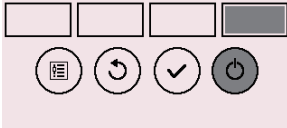
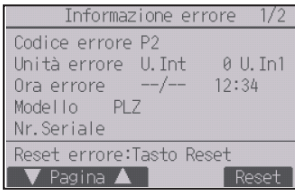

Premere il tasto **[F4]** o **[ON/OFF]** per azzerare l'errore che si è verificato.

Gli errori non possono essere azzerati quando l'operazione ON/OFF è proibita.

Selezionare "Ok" con il tasto **[F4]**.

Viene visualizzata una schermata di conferma.

Navigazione all'interno delle schermate

- Per tornare al Menu principale tasto **[MENU]**

Risoluzione dei problemi

Controllo informazioni errore



Quando non si verificano errori, può essere consultata la pagina 2/2 delle informazioni errore (vedere pagina 74) dal Menu Operazione. Selezionare menu “Manutenzione” dal Menu principale e premere il tasto **SCEGLI**.

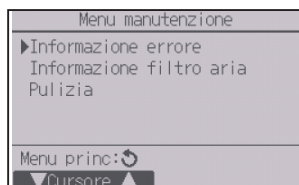

Per visualizzare la schermata Informazione errore, selezionare “Informazione errore” dal Menu manutenzione. Gli errori non possono essere azzerati.

Spegnimento automatico assenza

Sul modello di pannello 3D i-See sensor apparirà la seguente schermata se l'unità viene arrestata a causa della funzione Spegnimento automatico assenza dell'opzione risparmio energetico.

Consultare il Libretto di istruzioni dell'unità interna per l'impostazione del 3D i-See sensor.

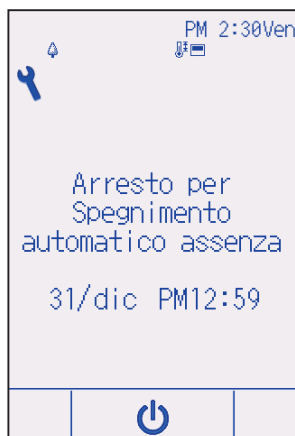

Manutenzione

Informazione filtro aria



 appare sul Display Stato e sul display Principale in modalità Completo quando è ora di pulire i filtri.

Lavare, pulire o sostituire i filtri quando appare il segnale.

Consultare il manuale di istruzioni dell'unità interna.

Tasto di funzionamento

1



Selezionare "Informazione filtro aria" dal Menu manutenzione e premere il tasto **[SCEGLI]**.

2



Premere il tasto **[F4]** per eseguire il reset della segnalazione del filtro.
Consultare il manuale di istruzioni dell'unità interna per la pulizia del filtro.

3



Selezionare "Ok" con il tasto **[F4]**.

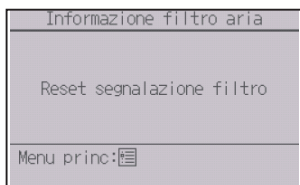

Viene visualizzata una schermata di conferma.

Navigazione all'interno delle schermate

- Per tornare al Menu principale tasto **[MENU]**
- Per tornare alla schermata precedente tasto **[INDIETRO]**



Quando  appare sul Display Stato e sul display Principale in modalità Completo, il sistema è controllato in maniera centrale e la segnalazione del filtro non può essere ripristinata.

Se due o più unità interne sono collegate, la durata della pulizia filtro per ogni unità può essere differente, secondo il tipo di filtro.

L'icona  appare quando il filtro nell'unità principale deve essere pulito.

Quando la segnalazione del filtro è ripristinata, verrà ripristinata anche la durata operativa cumulativa di tutte le unità.

L'icona  è programmata per apparire dopo una certa durata dell'operazione, secondo la premessa che le unità interne sono installate in uno spazio con qualità dell'aria normale. In base alla qualità dell'aria, il filtro potrebbe richiedere una pulizia più frequente.

La durata cumulativa in cui i filtri devono essere puliti dipende dal modello.

Specifiche

Specifiche controllo

	Specifiche
Dimensione prodotto	Standard (PAR-CT01MAA(R)-SB/PAR-CT01MAA-S): 65(L) × 120(A) × 14,1(P) mm (2 9/16 × 4 23/32 × 9/16 [in]) (escluse le parti che sporgono)
	Premium (PAR-CT01MAA(R)-PB): 68(L) × 120(A) × 14,1(P) mm (2 11/16 × 4 23/32 × 9/16 [in]) (escluse le parti che sporgono)
Peso netto	Standard (PAR-CT01MAA(R)-SB/PAR-CT01MAA-S): 0,09 kg (13/64 lb.)
	Premium (PAR-CT01MAA(R)-PB): 0,10 kg (7/32 lb.)
Tensione nominale alimentazione	12 VCC (fornita dalle unità interne)
Consumo energetico	0,6 W
Ambiente d'uso	Temperatura 0 ~ 40°C (32 ~ 104°F) Umidità 25 ~ 90% UR (senza condensa)
Materiale	Standard (PAR-CT01MAA(R)-SB/PAR-CT01MAA-S) Corpo principale: ABS
	Premium (PAR-CT01MAA(R)-PB) Corpo principale: ABS Piastra laterale: Alluminio

Elenco delle funzioni (in data 1 ottobre 2017)

○ : Supportato × : Non supportato

	Funzione	CITY MULTI	Mr. SLIM	Password necessaria
Alimentazione	Alimentazione ON/OFF	○	○	-
Impostazioni	Modalità operativa	○	○	-
	Modo Auto (impost punto doppio)	○	○	-
	Temperatura preimpostata	○	○	-
	Velocità ventilatore	○	○	-
	Deflettore	○	○	-
	Louver	○	○	-
	Recupero	○	○	-
Menu Operazione	High Power	×	○	-
	Angolo deflettore manuale	○	○	-
	3D i-See sensor	○	○	-
Menu Timer	Timer (On/Off Timer)	○	○	amministratore
	Timer (Timer Auto-Off)	○	○	amministratore
	Timer settimanale	○	○	amministratore
	Modo silenzioso Unità Esterna	○	○	amministratore
	Riduzione notturna	○	○	amministratore
Menu Risparmio energia	Restrizioni range temperatura	○	○	amministratore
	Funzione Operazioni proibite	○	○	amministratore
	Ripristino Automatico	○	○	amministratore
	Programma	×	○	amministratore
Menu impostazioni iniziali	Orologio	○	○	amministratore
	Impostazione formato display orologio	○	○	amministratore
	Ora legale	○	○	amministratore
	Display principale	○	○	amministratore
	Spiegazione icone	○	○	amministratore
	Luminosità	○	○	amministratore
	Selezione lingua	○	○	amministratore
	Design	○	○	amministratore
	Calibrazione schermo tattile	○	○	amministratore
	Pulizia dello schermo tattile	○	○	amministratore
Password (Amministratore)	○	○	amministratore	
Menu di Servizio	Reset controllo remoto	○	○	tecnico
	Informazioni controllo remoto	○	○	tecnico
	Prova funzionamento	○	○	tecnico
	Immissione informazioni modello	○	○	tecnico
	Immissione rivenditore	○	○	tecnico
	Impostazione funzioni	○	○	tecnico
	Manutenzione rapida	×	○	tecnico
	Password (Tecnico)	○	○	tecnico
Menu manutenzione	Discesa automatica griglia	○	○	-
	Informazione errore	○	○	-
	Informazione filtro aria	○	○	-

* Le funzioni supportate variano secondo il modello dell'unità.

Specifiche

Elenco delle funzioni che possono/non possono essere usate in combinazione

	High Power	On/Off Timer	Timer Auto-Off	Timer settimanale	Modo silenzioso Unità Esterna	Range temperatura	Operazioni proibite	Ripristino Automatico	Programma Risparmio energia	Riduzione notturna
High Power		○	○	○	△ 1	○	△ 2	○	△ 1	○
On/Off Timer	○		○	× 1	○	○	○	○	○	△ 3
Timer Auto-Off	○	○		○	○	○	○	○	○	△ 4
Timer settimanale	○	× 1	○		○	○	○	○	○	△ 5
Modo silenzioso Unità Esterna	△ 1	○	○	○		○	○	○	○	○
Range temperatura	○	○	○	○	○		○	× 2	○	△ 6
Operazioni proibite	△ 2	○	○	○	○	○		○	○	○
Ripristino Automatico	○	○	○	○	○	× 2	○		○	△ 7
Programma Risparmio energia	△ 1	○	○	○	○	○	○	○		○
Riduzione notturna	○	△ 3	△ 4	△ 5	○	△ 6	○	△ 7	○	

○ : Possono essere usati in combinazione × : Non possono essere usati in combinazione △ : Limitato

△ 1: Questa funzione è abilitata dopo il completamento dell'operazione High Power perché quest'ultima ha la priorità.

△ 2: Questa funzione non può essere azionata se qualche operazione è bloccata.

△ 3: La funzione Riduzione notturna non può essere utilizzata quando l'unità è in funzione con l'impostazione On/Off Timer.

△ 4: La funzione Auto-Off non può essere utilizzata per il funzionamento Riduzione notturna.

△ 5: La funzione Riduzione notturna non può essere utilizzata quando l'unità è in funzione con l'impostazione Timer settimanale.

△ 6: L'impostazione range temperatura non può essere utilizzata per il funzionamento Riduzione notturna.

△ 7: La funzione Ripristino Automatico non può essere utilizzata per il funzionamento Riduzione notturna.

× 1: L'impostazione Timer settimanale non è effettiva perché l'On/Off Timer ha la priorità.

× 2: La funzione Ripristino Automatico non può essere utilizzata perché l'impostazione Range temperatura ha la priorità.

Sistema de Controlo CITY MULTI
e Aparelhos de Ar Condicionado Mr. SLIM da Mitsubishi

Controlador Remoto Tátil MA

PAR-CT01MAA-PB

PAR-CT01MAA-SB

PAR-CT01MAA-S

PAR-CT01MAR-PB

PAR-CT01MAR-SB

Português

Livro de Instruções

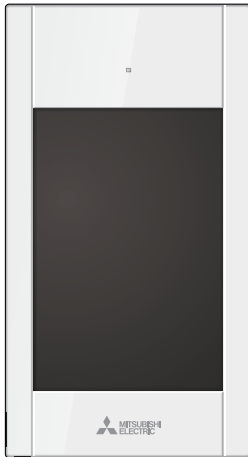

Antes de utilizar, leia cuidadosamente as instruções deste manual para utilizar corretamente o produto.

Guarde para futura referência.

Certifique-se de que este CD-ROM e o Manual de Instalação são entregues aos futuros utilizadores.



Para garantir a segurança e o funcionamento correto do controlador remoto, este apenas deverá ser instalado por pessoal qualificado.

Índice

Precauções de segurança.....	4
Componentes do controlador	6
Interface do controlador - Ecran Estado/Ecran principal	6
Interface do controlador - Ecrã de menus	8
Ecrã - Ecran Estado/Ecran principal.....	10
Estrutura de menus e ícones	12
Estrutura de menus	12
Explicações sobre os ícones	15
Operações básicas.....	16
Energia ON/OFF	16
Definições do modo de funcionamento, temperatura, velocidade da ventoinha, vane, louver e ventilação (Lossnay)	17
Navegar no menu	22
Lista do Menu principal.....	22
Navegar no Menu principal.....	24
Definições de função	25
Função turbo.....	25
Ângulo "vane" manual.....	26
Temporizador (On/Off temporizador)	29
Temporizador (Auto-Off temporizador)	32
Programação semanal.....	34
Modo silêncio da Unidade Externa	37
Função noite	40
Restrições.....	43
Poupança energética	49
Relógio.....	54
Hora de verão	56
Ecran principal	58
Explicação sobre os ícones	59
Brilho.....	61
Seleção do idioma	62
Design.....	64
Calibração do painel de toque	66
Limpeza do painel de toque.....	68
Restaurar controlador remoto	70
Informação do controlador remoto.....	72
Resolução de problemas.....	74
Informação de erro	74
Off auto por não ocupação	77
Manutenção.....	78
Informação de filtro	78
Especificações	80
Especificações do controlador.....	80
Lista de funções (a partir de 1 de outubro de 2017).....	81
Lista de funções que podem/não podem ser utilizadas em conjunto	82

Precauções de segurança

- Leia cuidadosamente as seguintes precauções de segurança antes de utilizar a unidade.
- Siga cuidadosamente estas precauções para garantir segurança.

 AVISO	Indica risco de morte ou ferimentos graves.
 ATENÇÃO	Indica risco de ferimentos graves ou danos estruturais.

- Depois de ler este manual, entregue-o ao utilizador final para que ele o guarde para referência futura.
- Guarde este manual para referência futura e consulte-o consoante necessário. Este manual deve estar disponível para aqueles que efetuam reparações ou mudam o controlador de local. Certifique-se de que o manual é entregue a todos os futuros utilizadores.

Precauções gerais

AVISO

Não instale a unidade num local onde existam grandes quantidades de óleo, vapor, solventes orgânicos ou gases corrosivos, como gás sulfúrico, ou onde se utilizem soluções ou pulverizadores ácidos/alcalinos com frequência. Estas substâncias podem comprometer o desempenho da unidade ou provocar a corrosão de alguns componentes da unidade, o que pode resultar num choque elétrico, avarias, fumo ou fogo.

Para reduzir o risco de curto-circuito, fuga de corrente, choque elétrico, avarias, fumo ou fogo, não lave o controlador com água ou qualquer outro líquido.

Para reduzir o risco de um choque elétrico, avarias, fumo ou fogo, não utilize os interruptores/botões nem toque noutras peças elétricas com as mãos molhadas.

Quando desinfetar a unidade com álcool, ventile o espaço de forma adequada. Os vapores do álcool em volta da unidade podem provocar fogo ou explosão quando a unidade estiver ligada.

Para reduzir o risco de ferimentos ou de um choque elétrico, interrompa sempre o funcionamento e tape o controlador antes de pulverizar um produto químico na área próxima do controlador.

Para reduzir o risco de ferimentos ou de um choque elétrico, interrompa sempre o funcionamento e desligue da alimentação antes de efetuar a limpeza, manutenção ou inspeção do controlador.

Se detetar alguma anomalia (por ex., cheiro a queimado), interrompa o funcionamento, desligue a alimentação e consulte o seu assistente. A utilização continuada do produto pode dar origem a choques elétricos, avarias ou fogo.

Instale corretamente todas as tampas necessárias para proteger o controlador da humidade e do pó. A acumulação de pó e água pode causar um choque elétrico, fumo ou fogo.

ATENÇÃO

Para reduzir o risco de fogo ou explosão, não coloque materiais inflamáveis nem utilize pulverizadores inflamáveis na área próxima do controlador.

Para reduzir o risco de danos no controlador, não pulverize inseticida ou outros pulverizadores inflamáveis diretamente no controlador.

Para reduzir o risco de poluição ambiental, consulte um entidade autorizada para eliminar corretamente o controlador remoto.

Para reduzir o risco de um choque elétrico ou avarias, não toque no painel táctil, interruptores ou botões com um objeto pontiagudo ou afiado.

Para reduzir o risco de ferimentos e choque elétrico, evite tocar nas extremidades afiadas de algumas peças.

Para reduzir o risco de ferimentos, utilize vestuário de proteção ao trabalhar com o controlador.

Para evitar ferimentos provocados por vidro partido, não exerça demasiada força nas peças de vidro.

Precauções para mover ou reparar o controlador

AVISO

O controlador deve ser reparado ou movido apenas por pessoal qualificado. Não desmonte nem modifique o controlador. Quaisquer instalações ou reparação incorretas podem provocar ferimentos, choque elétrico ou fogo.

ATENÇÃO

Para reduzir o risco de curto-circuito, choque elétrico, fogo ou avarias, não toque na placa de circuito com ferramentas ou com as mãos, e não permita que se acumule pó na placa de circuito.

Precauções adicionais

Para evitar danos no controlador, utilize as ferramentas adequadas para instalar, inspecionar ou reparar o controlador.

Este controlador foi concebido para uso exclusivo com o Sistema de Gestão de Edifícios da Mitsubishi Electric. A utilização deste controlador com outros sistemas ou com qualquer outro propósito pode provocar avarias.

Este aparelho não deve ser utilizado por pessoas (incluindo crianças) com capacidades físicas, sensoriais ou mentais reduzidas, nem sem experiência ou conhecimento de causa, exceto no caso de terem recebido instrução ou orientação sobre a utilização do aparelho por parte de um responsável. As crianças devem ser supervisionadas para garantir que não brincam com o aparelho.

Para evitar descoloração, não utilize benzeno, diluentes ou produtos de limpeza químicos para limpar o controlador. Para limpar o controlador, use um pano macio humedecido em água com detergente neutro, retire o detergente com um pano molhado e seque a água com um pano seco.

Para evitar danos no controlador, tenha o cuidado de instalar proteção suficiente contra eletricidade estática.

Este aparelho destina-se a ser utilizado por profissionais ou utilizadores com formação em lojas, pequenas indústrias e explorações agrícolas ou para uso comercial por leigos.

Se o cabo de alimentação estiver danificado, tem de ser substituído pelo fabricante, agente autorizado ou pessoa qualificada, a fim de evitar riscos.

Componentes do controlador

Interface do controlador - Ecran Estado/Ecran principal

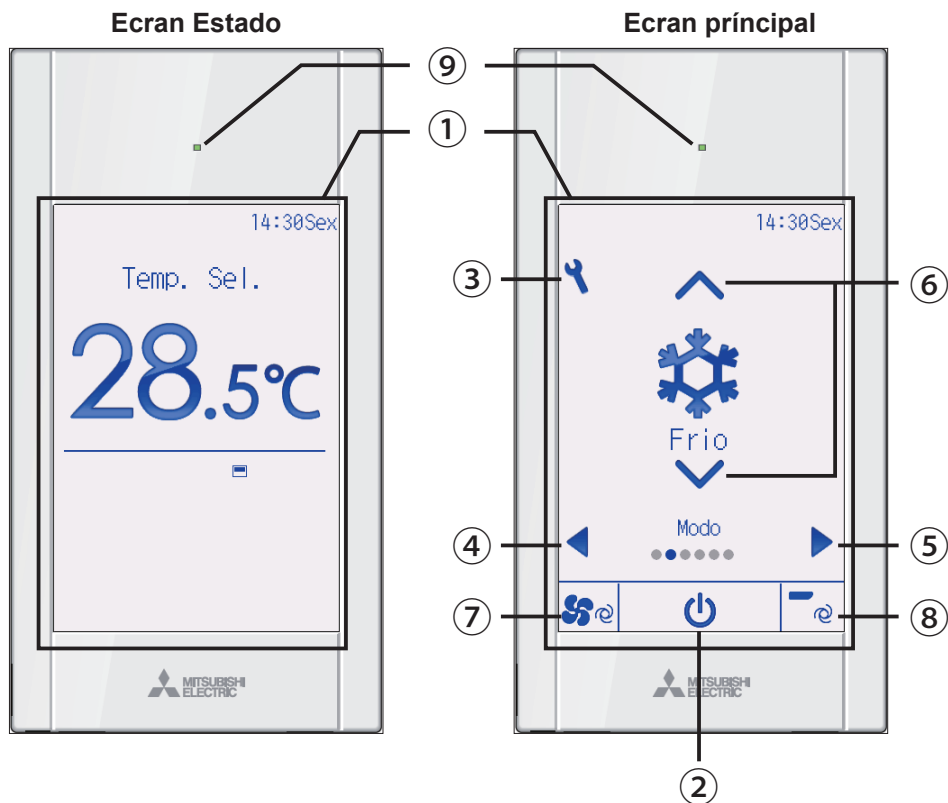

① Painel tátil e LCD retroiluminado a cores

As Definição Operação irão aparecer. Se a retroiluminação estiver desligada, uma pressão em qualquer área comuta o ecrã para o Ecran Estado. Quando o Ecran Estado for apresentado, premir qualquer área altera o ecrã para o Ecran principal.

② Botão **LIGAR/DESLIGAR**

Prima LIGAR/DESLIGAR para ligar/desligar a unidade interna.

③ Botão **Definição**

Prima para invocar o Menu principal. Quando o menu de funcionamento está bloqueado é necessária uma palavra-passe de administrador.

④ Botão

Prima para comutar entre itens de definição pela ordem seguinte: louver, ventilação, vane, velocidade da ventoinha, modo de funcionamento e temperatura predefinida.

⑤ Botão

Prima para comutar entre itens de definição pela ordem seguinte: temperatura predefinida, modo de funcionamento, velocidade da ventoinha, vane, ventilação e louver.

⑥ Botão

Prima para alterar o conteúdo da definição selecionada em ④ e ⑤ acima.

⑦ Botão de atalho de velocidade da ventoinha

Prima para aceder diretamente ao ecrã de definições de velocidade da ventoinha.

⑧ Botão de atalho de vane

Prima para aceder diretamente ao ecrã de definições da vane.

⑨ Lâmpada ON/OFF

Esta lâmpada fica acesa a verde enquanto a unidade estiver a funcionar, a menos que “Iluminação LED” esteja definida como “Não”. Fica intermitente enquanto o controlador remoto está a ser iniciado ou quando ocorrer um erro.

Se a operação de ON/OFF estiver bloqueada, ② não será mostrado.

Quando o item de definição é comutado com o botão ④ ou ⑤, se a operação do item de definição selecionado estiver bloqueada, o item não será mostrado.

Se a operação de velocidade da ventoinha ou vane estiver bloqueada, o item ⑦ ou ⑧ não será mostrado.

Os conteúdos das definições não podem ser mudados com o botão ⑥ se o item de definição for controlado centralmente pelo controlador do sistema.

Componentes do controlador

Interface do controlador - Ecrã de menus



① Botão **LIGAR/DESLIGAR**

Prima LIGAR/DESLIGAR para ligar/desligar a unidade interna.

② Botão **SELECIONAR**

Prima para guardar a definição.

③ Botão **VOLTAR**

Prima para voltar ao ecrã anterior. Quando é visualizado o Menu principal, ao premir este botão, mostrar-se-á o Ecran Estado.

④ Botão **MENU**

Página 24

Prima para invocar o Menu principal.

⑤ Botão de função **F1**

Ecrã de menu: A função do botão varia conforme o ecrã.

⑥ Botão de função **F2**

Menu principal: Prima para mover o cursor para a esquerda.

Ecrã de menu: A função do botão varia conforme o ecrã.

⑦ Botão de função **F3**

Menu principal: Prima para mover o cursor para a direita.

Ecrã de menu: A função do botão varia conforme o ecrã.

⑧ Botão de função **F4**

Ecrã de menu: A função do botão varia conforme o ecrã.

As funções dos botões de função mudam consoante o ecrã. Consulte o guia de função do botão que aparece na parte inferior do LCD para saber quais as funções que desempenham num determinado ecrã.

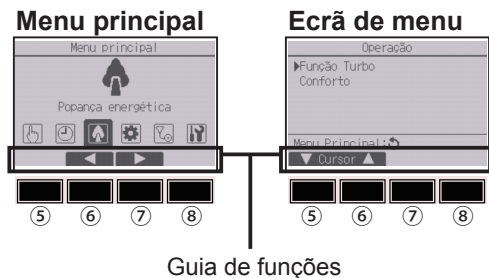

Componentes do controlador

Ecrã - Ecran Estado/Ecran principal

O Ecrã de estado e o Ecran principal podem ser apresentados de dois modos diferentes: “Completo” e “Básico.”

A predefinição é “Completo.” Para saber como alternar o modo, consulte a página 58.

Modo Completo

* Todos os ícones são visualizados para obter uma explicação.

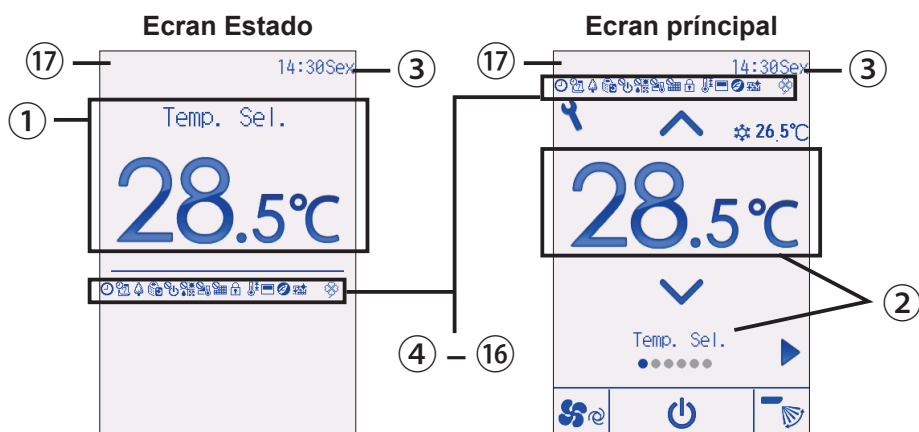

Modo Básico

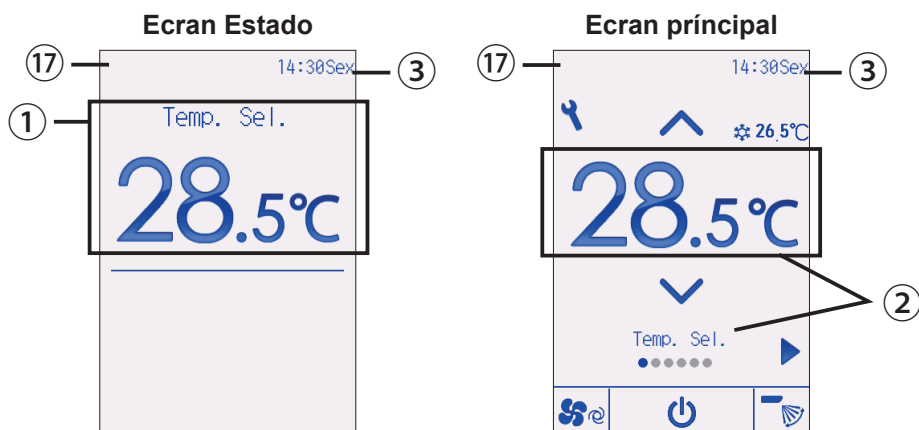

① Temperatura predefinida ou temperatura ambiente

A temperatura predefinida ou a temperatura ambiente são visíveis aqui. (Consulte o Manual de Instalação.)

② Item de definição e conteúdos das definições Página 17

Os itens de definição “Temperatura predefinida” ↔ “Modo de funcionamento” ↔ “Velocidade da ventoinha” ↔ “Vane” ↔ “Ventilação” ↔ “Louver” e os respetivos conteúdos das definições aparecem aqui. “Controlado centralmente” aparece por um determinado período de tempo quando é utilizado um item controlado centralmente.

③ Relógio

A hora atual é aqui apresentada. (Consulte o Manual de Instalação.)

④ Página 29, 32, 40

Surge quando a função On/Off temporizador (Página 29), Função noite (Página 40) ou Auto-off temporizador (Página 32) está ativada.

 aparece quando o temporizador for desativado pelo sistema de controlo centralizado.

⑤ Página 34

Surge quando a Programação semanal estiver ativada.

⑥ Página 51

Surge enquanto as unidades estão a funcionar no modo de poupança energética. (Não aparecerá em alguns modelos de unidades internas)

⑦ Página 37

Surge enquanto as unidades externas estão a funcionar no modo silêncio.

⑧

Surge quando a operação ON/OFF é controlada centralmente.

⑨

Surge quando o modo de funcionamento é controlado centralmente.

⑩

Surge quando a temperatura predefinida estiver controlada centralmente.

⑪

Surge quando a função de eliminação do reposição do filtro estiver controlada centralmente.

⑫

Página 46

Surge quando os botões estão bloqueados.

⑬

Página 43

Surge quando o intervalo de temperatura predefinido estiver restringido.

⑭

Surge quando o termístor integrado no controlador remoto for ativado para monitorizar a temperatura ambiente.

 aparece quando o termístor na unidade interna é ativado para monitorizar a temperatura ambiente.

⑮

Surge quando uma operação de poupança de energia é efetuada com uma função do “3D i-See sensor”.

⑯

Página 78

Indica quando o filtro necessita de manutenção.

⑰ **Visualização de erro preliminar**

Aparece um código de erro durante o erro preliminar.

Estrutura de menus e ícones

Estrutura de menus

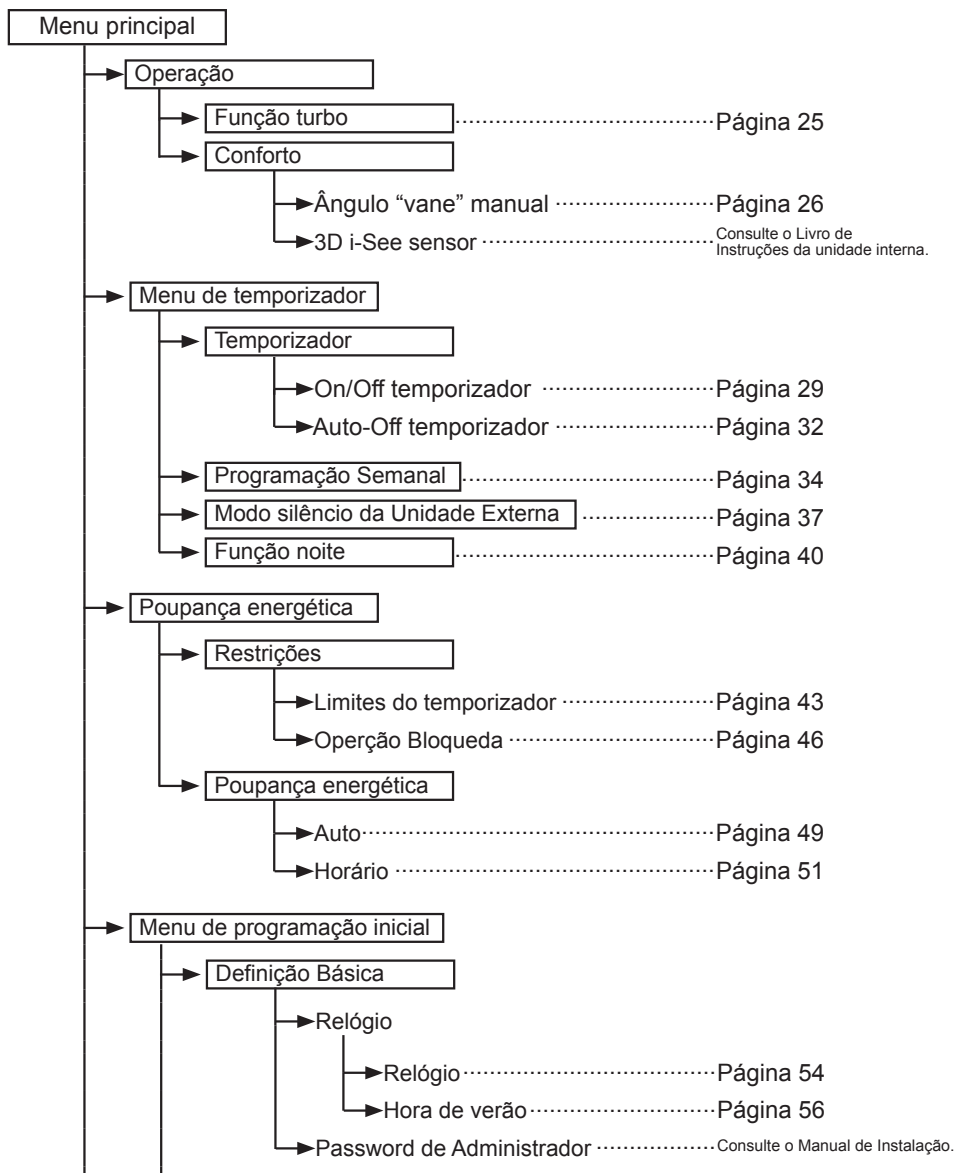

→	Definição Ecran	
	→ Ecran principal	Página 58
	→ Detalhes do ecran (Explicações sobre os ícones, etc.)	Consulte o Manual de Instalação.
	→ Brilho	Página 61
	→ Seleção do idioma	Página 62
	→ Design	Página 64
→	Definição Operação	
	→ Modo automático	Consulte o Manual de Instalação.
→	Painel de toque	Página 66
→	Menu Manutenção	
	→ Informação de erro	Página 74
	→ Informação de filtro	Página 78
	→ A limpar	
	→ Descer painel auto	Consulte o Manual de Instruções fornecido com o painel de elevação automática.
	→ Operação de descida	Consulte o Manual de Instruções fornecido com o painel de elevação automática.
	→ Ajuste da descida	Consulte o Manual de Instruções fornecido com o painel de elevação automática.
→	Menu de assistência	
	→ Menu de teste de funcionamento	
	→ Testar funcionamento	Consulte o Manual de Instalação da unidade interna.
	→ Teste da bomba condensados	Consulte o Manual de Instalação da unidade interna.
	→ Informação Manutenção	Consulte o Manual de Instalação da unidade interna.
	→ Nome do Modelo	Consulte o Manual de Instalação da unidade interna.
	→ Introduzir N° Série	Consulte o Manual de Instalação da unidade interna.
	→ Introduzir Informação de Assistência	Consulte o Manual de Instalação da unidade interna.
	→ Iniciar informações sobre manutenção	Consulte o Manual de Instalação da unidade interna.

Estrutura de menus e ícones

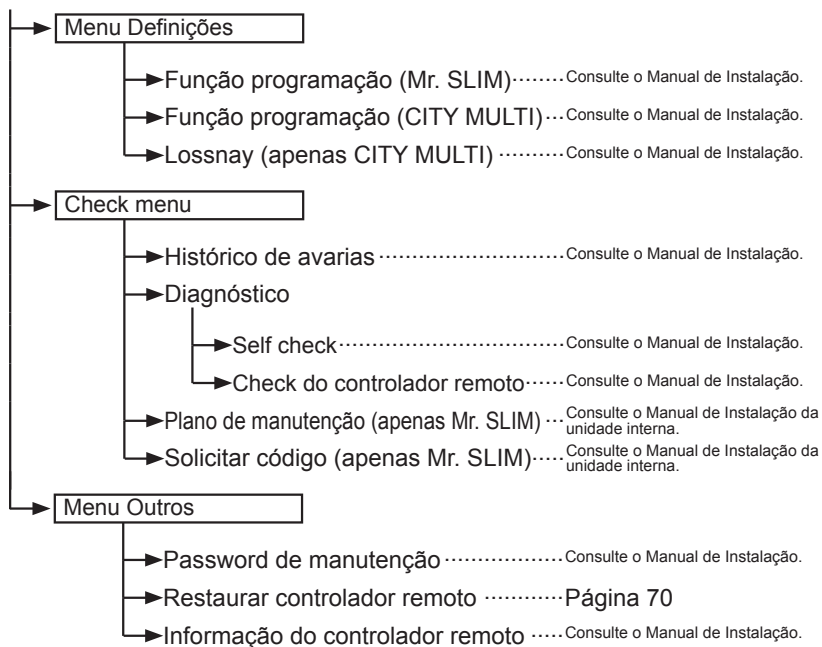

Nem todas as funções estão disponíveis em todos os modelos de unidades internas.

Explicações sobre os ícones

Funcionamento do controlador

Temporizador



A tabela em baixo resume os ícones quadrados utilizados neste manual.



A senha de utilizador do administrador ou de manutenção deve ser introduzida no ecrã de introdução de senha para alterar as definições. Não existem definições que possam ignorar este processo.

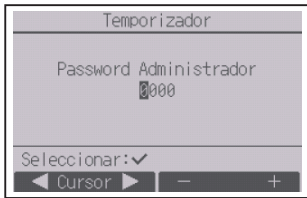

- F1** : Prima para mover o cursor para a esquerda.
- F2** : Prima para mover o cursor para a direita.
- F3** : Prima para diminuir o valor em 1.
- F4** : Prima para aumentar o valor em 1.



F1 F2 F3 F4

* As alterações não podem ser efetuadas, exceto se for introduzida a password correta.



Indica que as definições apenas podem ser alteradas enquanto as unidades estão a funcionar.



Indica que as definições apenas podem ser alteradas enquanto as unidades não estão a funcionar.



Indica que as definições apenas podem ser alteradas enquanto as unidades estão a funcionar nos modos Frio, Calor ou Auto.



Indica as funções que não estão disponíveis quando os botões estão bloqueados ou o sistema está controlado centralmente.

Operações básicas

Energia ON/OFF



Operação do botão

ON



Prima o botão **LIGAR/DESLIGAR**.

A lâmpada ON/OFF fica acesa a verde e a operação será iniciada.

Se "Iluminação LED" estiver definida como "Não", a lâmpada ON/OFF não acenderá.

botão **LIGAR/DESLIGAR**

OFF



Prima novamente o botão **LIGAR/DESLIGAR**.

A lâmpada ON/OFF irá apagar e o funcionamento será interrompido.

Definições do modo de funcionamento, temperatura, velocidade da ventoinha, vane, louver e ventilação (Lossnay)



Operação do botão

Modo de funcionamento



Cada pressão do botão ▼ ou ▲ passa pelos modos de funcionamento seguintes.

Selecione o modo de funcionamento pretendido.



Frio



Desumidificação



Ventoinha



Auto



Calor

- Os modos de funcionamento que não estão disponíveis nos modelos de unidades internas ligadas não são apresentados no ecrã.

O que significa um ícone no modo intermitente

O ícone do modo fica intermitente quando outras unidades internas no mesmo sistema refrigerante (ligadas à mesma unidade externa) já estiverem a funcionar num modo diferente. Neste caso, o resto da unidade no mesmo grupo apenas pode funcionar no mesmo modo.

<Modo Auto (ponto de definição duplo)>

Quando o modo de funcionamento é definido para o modo Auto (ponto de definição duplo), é possível definir duas temperaturas predefinidas (uma para arrefecimento e outra para aquecimento). Dependendo da temperatura ambiente, a unidade interna funcionará automaticamente no modo Frio ou Calor e manterá a temperatura ambiente dentro dos limites predefinidos.

O gráfico abaixo mostra o padrão de funcionamento da unidade interna quando a mesma está a funcionar no modo Auto (ponto de definição duplo).

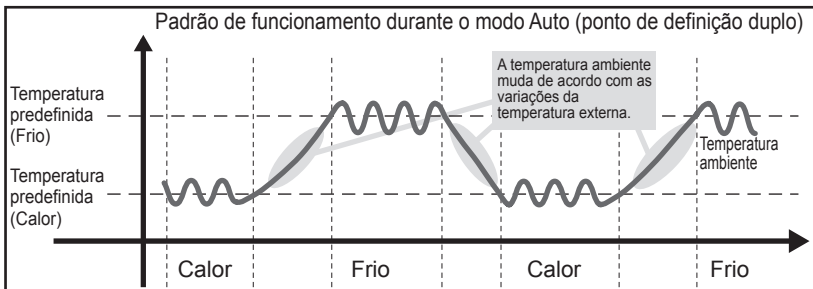

Operações básicas

Temperatura predefinida

<Frio, Desumidificação, Calor e Auto (ponto de definição único)>



Prima o botão ▼ para diminuir a temperatura predefinida e o botão ▲ para aumentá-la.

- Consulte a tabela na página 19 para os limites de temperatura que podem ser definidos nos diferentes modos de funcionamento.
- Os limites de temperatura predefinidos não podem ser definidos para o funcionamento Ventoinha/Ventilação.
- A temperatura predefinida será exibida em graus Centígrados, em incrementos de 0,5 ou 1 grau, ou em Fahrenheit, dependendo do modelo da unidade interna e das definições do modo de exibição do controle remoto.

<Modo Auto (ponto de definição duplo)>

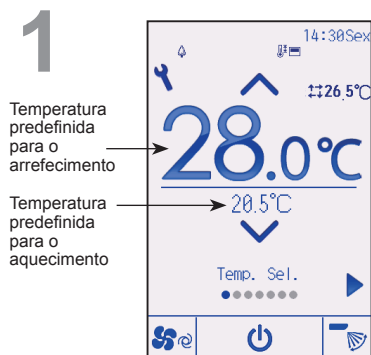

A temperatura predefinida atual irá aparecer. Cada pressão do botão ◀ ou ▶ comuta as temperaturas predefinidas para arrefecimento e aquecimento.

2

Temperatura predefinida para o arrefecimento

Temperatura predefinida para o aquecimento

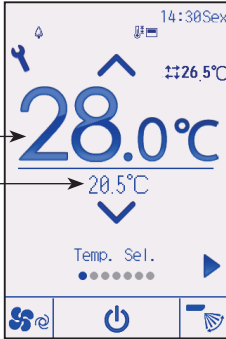

Prima o botão ▼ para diminuir a temperatura selecionada e o botão ▲ para aumentá-la.

- Consulte a tabela abaixo para os limites de temperatura que podem ser definidos nos diferentes modos de funcionamento.
- As definições da temperatura predefinida para arrefecimento e aquecimento no modo Auto (ponto de definição duplo) também são utilizadas pelos modos Frio/Desumidificação e Calor.
- As temperaturas predefinidas para arrefecimento e aquecimento no modo Auto (ponto de definição duplo) devem respeitar as condições abaixo:
 - A temperatura de arrefecimento predefinida é superior à temperatura de aquecimento predefinida.
 - O requisito mínimo de diferença de temperatura entre as temperaturas predefinidas de arrefecimento e aquecimento (varia conforme os modelos das unidades internas ligadas) é cumprido.
 - Se as temperaturas predefinidas forem definidas numa forma que não cumpra o requisito mínimo de diferença de temperatura, ambas as temperaturas predefinidas serão alteradas automaticamente para que estejam dentro dos limites de definição permitidos.

Limites de temperatura passíveis de ser predefinidos

Modo de funcionamento	Limite de temperatura predefinido
Frio/Desumidificação	19 ~ 30°C (67 ~ 87°F)
Calor	17 ~ 28°C (63 ~ 83°F)
Auto (Ponto de definição único)	19 ~ 28°C (67 ~ 83°F)
Auto (Pontos de definição duplos)	[Frio] Limites da temperatura predefinida para o modo Frio [Calor] Limites da temperatura predefinida para o modo Calor
Ventoinha/Ventilação	Não pode ser definido

Os limites de temperatura passíveis de serem definidos variam consoante o modelo das unidades internas.

Operações básicas

Velocidade da ventoinha

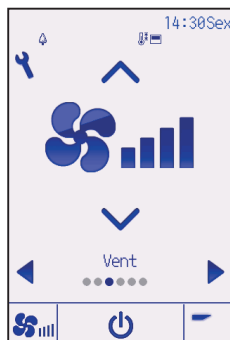

Cada pressão do botão ▼ ou ▲ passa pelas velocidades da ventoinha seguintes.

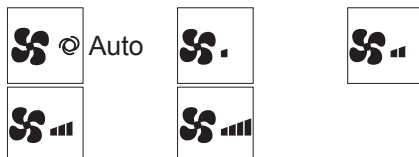

- As velocidades da ventoinha disponíveis dependem dos modelos das unidades internas ligadas.

Definição da “vane”



(Ecrã de exemplo em CITY MULTI)

Cada pressão do botão ▼ ou ▲ passa pelas definições da vane seguintes.

Selecione a definição pretendida.

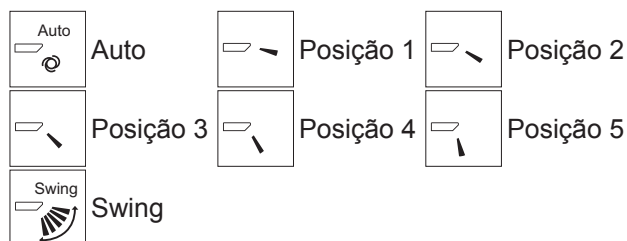

Selecione “Swing” para mover automaticamente as “vanes” para cima e para baixo.

Quando definida desde a “Posição 1” até à “Posição 5”, a “vane” ficará fixa no ângulo selecionado.

- Ícone de definição (1h) à esquerda da “vane”
Este ícone irá aparecer quando a “vane” estiver definida para a Posição 2, 3, 4 ou 5 e a ventoinha estiver a funcionar a baixa velocidade durante uma operação de arrefecimento ou desumidificação (consoante o modelo).
O ícone desaparece em uma hora e a definição da vane será automaticamente alterada.

Definição do louver

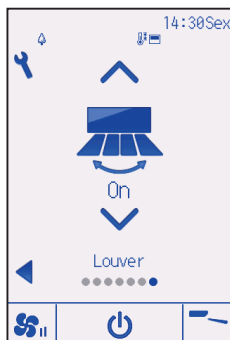

(Ecrã de exemplo em CITY MULTI)

Prima o botão ▼ ou ▲ para ligar ou desligar a oscilação do louver.

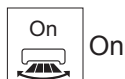

Definição da ventilação

A definição da ventilação pode efetuar-se mesmo quando as unidades estão em funcionamento.



(Ecrã de exemplo em Mr. SLIM)

Cada pressão do botão ▼ ou ▲ passa pelas definições da ventilação seguintes.

* Pode definir-se apenas quando a unidade Lossnay estiver ligada.



• Em alguns modelos das unidades internas, a ventoinha pode estar interligada com determinados modelos de unidades de ventilação.

Navegar no menu

Lista do Menu principal

Menu principal	Itens de definição		Detalhes da definição	Página
Operação	Função turbo		Utilize para alcançar rapidamente uma temperatura ambiente agradável. • As unidades podem ser utilizadas no modo de Função turbo durante um máximo de 30 minutos.	25
	Conforto	Ângulo “vane” manual	Utilize para regular cada ângulo vane.	26
Temporizador	Temporizador	On/Off temporizador	Utilize para definir o tempos On/Off do funcionamento. • O tempo pode ser definido em incrementos de 5 minutos. * Definição do relógio necessária.	29
		Auto-Off temporizador	Utilize para definir o tempo de Auto-Off. • O tempo pode ser definido para um valor de 30 a 240 minutos, em incrementos de 10 minutos.	32
	Programação semanal		Utilize para definir os tempos On/Off de funcionamento semanal. • Por dia, podem ser definidos, no máximo, oito padrões de funcionamento. • É possível definir dois tipos de calendário semanal. * Definição do relógio necessária. * Não é válido quando On/Off temporizador estiver ativado. * Incrementos de 1°C	34
	Modo silêncio da Unidade Externa		Utilize para definir os períodos de tempo nos quais é dada prioridade a um funcionamento silencioso das unidades externas em vez do controlo da temperatura. Defina os tempos de Início/Fim para cada dia da semana. • Selecione o nível de silêncio pretendido de entre “Normal,” “Intermédio” e “Silencioso”. * Definição do relógio necessária.	37
	Função noite		Utilize para as efetuar as definições da Função noite. • Selecione “Sim” para ativar a definição e “Não” para desativar a definição. Podem ser definidos os limites da temperatura e os tempos de início/fim. * Definição do relógio necessária. * Incrementos de 1°C	40
Poupança energética	Restrições	Limites de temperatura	Utilize para restringir os limites de temperatura predefinidos. • Os vários limites de temperatura podem ser definidos para diferentes modos de funcionamento. * Incrementos de 1°C	43
		Operação Bloqueada	Utilize para bloquear as funções selecionadas. • As funções bloqueadas não podem ser utilizadas.	46
	Poupança energética	Auto	Utilize para que as unidades funcionem à temperatura predefinida depois de um funcionamento com poupança energética durante um período de tempo especificado. • O tempo pode ser definido para um valor de 30 a 120 minutos, em incrementos de 10 minutos. * Esta função não será válida quando os limites da temperatura predefinidos forem restringidos. * Incrementos de 1°C	49

Menu principal	Itens de definição		Detalhes da definição	Página
Poupança energética	Poupança energética	Horário	<p>Defina os tempos de início/fim para que as unidades funcionem no modo de poupança energética em cada dia da semana e defina a taxa de poupança energética.</p> <ul style="list-style-type: none"> • Por dia, podem ser definidos, no máximo, quatro padrões de funcionamento em poupança energética. • O tempo pode ser definido em incrementos de 5 minutos. • A taxa de poupança energética pode ser definida para um valor de 0% e 50 a 90% em incrementos de 10%. <p>* Definição do relógio necessária.</p>	51
Programação inicial	Definição Básica	Relógio	Utilize para definir o tempo atual.	54
		Hora de verão	Define a hora de verão.	56
	Definição Ecran	Ecran principal	Utilize para alternar entre os modos “Completo” e “Básico” no Ecran Estado e no Ecran principal. • A predefinição é “Completo.”	58
		Brilho	Utilize para ajustar o brilho do ecrã.	61
		Seleção do idioma	Utilize para seleccionar o idioma pretendido.	62
		Design	Utilize para mudar a cor do Ecran Estado e do Ecran principal.	64
	Painel de toque	Calibração do painel de toque	Estabelece as definições de calibração do painel de toque.	66
		Limpeza do painel de toque	Inibe temporariamente a sensibilidade ao toque do painel de toque para permitir a limpeza.	68
Assistência	Restaurar controlador remoto	Utilize para restaurar o controlador remoto para o estado de fábrica.	70	
	Informação do controlador remoto	Serve para visualizar o nome do modelo, a versão de software e o número de série do controlador remoto.	72	
Manutenção	Informação de erro	<p>Utilize para verificar as informações do erro quando ocorre um erro.</p> <ul style="list-style-type: none"> • O código de erro, origem do erro, endereço do refrigerante, modelo da unidade, número de fabrico e informações de contacto (número de telefone de assistência) podem ser visualizados. <p>* O modelo da unidade, número de fabrico e informações de contacto devem ser registados antecipadamente para serem visualizados.</p>	74	
	Informação de filtro	<p>Utilize para verificar o estado do filtro.</p> <ul style="list-style-type: none"> • O símbolo do filtro pode ser apagado. 	78	

Navegar no menu

Navegar no Menu principal

Operação do botão

Aceder ao Menu principal



Prima o botão **Definição** no Ecran principal.

Irá surgir o Menu principal.

Seleção do item



Prima **F2** para mover o cursor para a esquerda.

Prima **F3** para mover o cursor para a direita.

Cursor

Definições de função

Função turbo



Descrição da função

A função turbo permite que as unidades funcionem a uma capacidade superior ao normal, de modo a que o ar ambiente possa ser rapidamente condicionado a uma temperatura ideal. Esta operação irá durar, no máximo, 30 minutos e a unidade voltará ao modo de funcionamento normal no final dos 30 minutos ou quando a temperatura ambiente atingir a temperatura predefinida, o que for alcançado primeiro. As unidades regressarão ao funcionamento normal quando o modo de funcionamento ou a velocidade da ventoinha for alterada.

Operação do botão

1

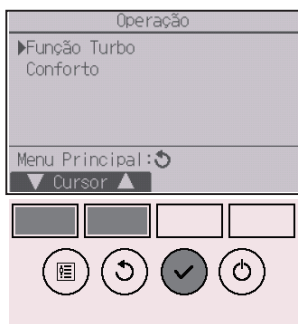

Selecione “Função Turbo” no menu de Operação durante as operações de Arrefecimento, Aquecimento ou Auto e prima o botão **SELECIONAR**.

A “Função turbo” está disponível apenas nos modelos que suportam a função.

2



Mova o cursor para “Sim” com o botão **F3** ou **F4** e prima o botão **SELECIONAR**.

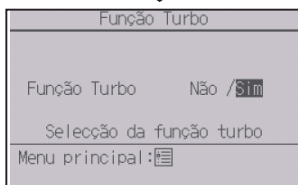

Irá surgir um ecrã de confirmação.

Navegar nos ecrãs

- Para voltar ao Menu principal botão **MENU**
- Para voltar ao ecrã anterior botão **VOLTAR**

Definições de função

Ângulo “vane” manual

OFF

Operação do botão

1

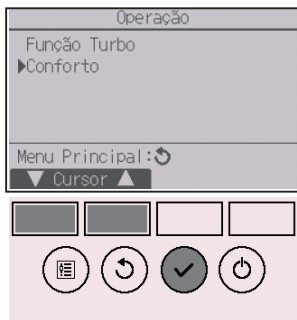

Selecione “Conforto” no menu de Operação e prima o botão **[SELECIONAR]**.

2



Selecione “Ângulo ‘vane’ manual” com o botão **[F1]** ou **[F2]** e prima o botão **[SELECIONAR]**.

3



Mova o cursor para “Endereço Ref” ou “N.º Unidade” com o botão **[F1]** para selecionar.

Com o botão **[F2]** ou **[F3]**, selecione o endereço do refrigerante e o número da unidade para as unidades cujas “vanes” serão fixadas e prima o botão

[SELECIONAR].

- Endereço Ref: Endereço do refrigerante

- N.º Unidade: 1, 2, 3, 4

Prima o botão **[F4]** para confirmar a unidade.

O ecrã à esquerda mostra um exemplo de ecrã em Mr. SLIM. Nas unidades CITY MULTI, o “Endereço MNET” é visualizado em vez do “Endereço Ref” e o “N.º Unidade” não será mostrado.

4

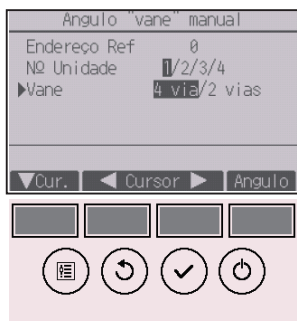

Selecione “Vane” com o botão **[F1]**.

Selecione “4 vias” ou “2 vias” com o botão **[F2]** ou **[F3]** e prima o botão **[F4]**.

Definições de função

5

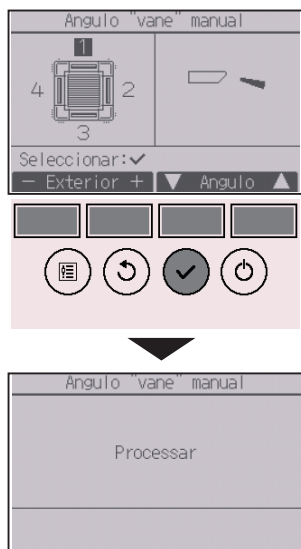

A definição atual da “vane” irá aparecer.

Selecione as saídas desejadas “1”, “2”, “3”, “4” ou “1, 2, 3, 4 (todas as saídas)” com o botão [F1] ou [F2].

Prima o botão [F3] ou [F4] para percorrer as opções seguintes e selecione a definição pretendida.

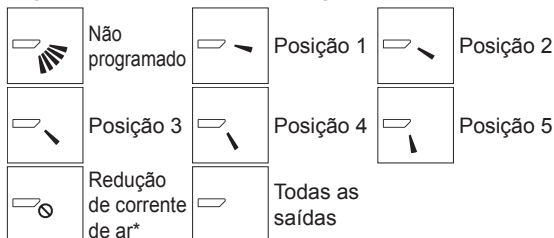

Prima o botão [SELECIONAR] para guardar as definições. Irá surgir um ecrã que indica que a informação da definição está a ser transmitida.

As alterações das definições serão efetuadas para a saída selecionada.

O ecrã irá regressar automaticamente ao ecrã anterior quando a transmissão estiver concluída.

Efetue as definições para outras saídas, procedendo da mesma forma.

Se todas as saídas forem selecionadas, ver-se-á
 **da próxima vez que a unidade entrar em funcionamento.**

Navegar nos ecrãs

• Para voltar ao ecrã anterior botão [VOLTAR]

*Redução de corrente de ar

O modo [Redução de corrente de ar] mantém o ângulo “vane” mais horizontal do que o ângulo da opção Posição 1 para que o fluxo de ar não seja orientado diretamente para as pessoas.

Esta função pode ser definida apenas para uma saída.

Esta função não pode ser definida para modelos com duas ou três saídas.

No modo Redução de corrente de ar, o fluxo de ar pode provocar a descoloração do teto.

Temporizador (On/Off temporizador)



Operação do botão

1



Selecione “Temporizador” no Menu principal (consulte a página 24) e prima o botão **SELECIONAR**.

On/Off temporizador não irá funcionar nos seguintes casos:

Quando On/Off temporizador estiver desativado, durante um erro, durante uma verificação (no menu de assistência), durante um teste de funcionamento, durante um diagnóstico do controlador remoto, quando o relógio não estiver definido, durante a definição de funções, quando o sistema estiver controlado centralmente (quando a operação de On/Off ou a operação do temporizador estão proibidas).

2

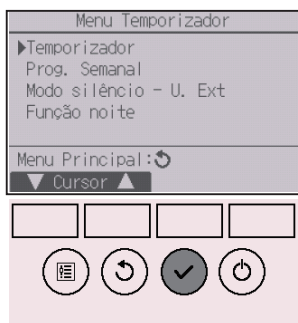

Mova o cursor para “Temporizador” e prima o botão **SELECIONAR**.

3

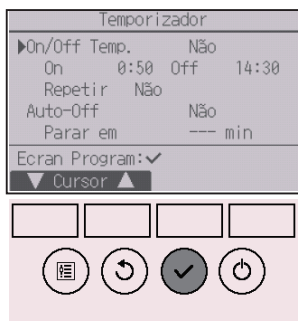

As definições atuais irão aparecer.

Mova o cursor para “On/Off Temp.” e prima o botão **SELECIONAR**.

Definições de função

4



Irá surgir o ecrã que lhe permite definir o temporizador.

Selecione o item pretendido com o botão **F1** ou **F2** de entre “On/Off Temp.”, “On”, “Off” ou “Repetir”.

5



Altere a definição com o botão **F3** ou **F4**.

- On/Off temporizador: Não (desativar)/Sim (ativar)
- On: Hora de início da operação
(pode ser definido em incrementos de 5 minutos)
* Prima e mantenha premido o botão para avançar rapidamente os números.
- Off: Hora de fim da operação
(pode ser definido em incrementos de 5 minutos)
* Prima e mantenha premido o botão para avançar rapidamente os números.
- Repetir: Não (uma vez)/Sim (repetir)

6



Prima o botão **SELECIONAR** para guardar as definições.

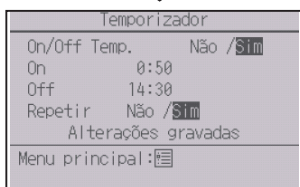



Irá surgir um ecrã de confirmação.

Navegar nos ecrãs

- Para voltar ao Menu principal botão **MENU**
- Para voltar ao ecrã anterior botão **VOLTAR**



 irá aparecer no Ecran Estado e o Ecran principal em Modo completo quando On/Off temporizador é ativado.

 aparece quando o temporizador for desativado pelo sistema de controlo centralizado.

Definições de função

Temporizador (Auto-Off temporizador)



Operação do botão

1



Invoque o ecrã de definição do Temporizador.
(Consulte a página 29.)

Selecione “Auto-Off” e prima o botão **[SELECIONAR]**.

Auto-Off temporizador não irá funcionar nos seguintes casos:

Quando Auto-Off temporizador estiver desativado, durante um erro, durante uma verificação (no menu de assistência), durante um teste de funcionamento, durante um diagnóstico do controlador remoto, durante a definição de funções, quando o sistema estiver controlado centralmente (quando a operação de On/Off ou a operação do temporizador estão proibidas).

2



As definições atuais irão aparecer.

Mova o cursor para “Auto-Off” ou “Parar em --- min” com o botão **[F1]** ou **[F2]**.

3



Altere a definição com o botão **[F3]** ou **[F4]**.

- Auto-Off: Não (desativar)/Sim (ativar)
- Parar em --- min: Definição do temporizador (pode ser definido um limite de 30 a 240 minutos em incrementos de 10 minutos.)

4



Prima o botão **SELECIONAR** para guardar as definições.

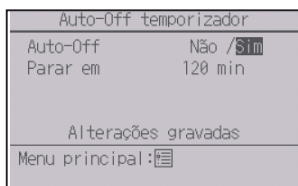



Irá surgir um ecrã de confirmação.

Navegar nos ecrãs

- Para voltar ao Menu principal botão **MENU**
- Para voltar ao ecrã anterior botão **VOLTAR**



 irá aparecer no Ecran Estado e o Ecran principal em Modo completo quando Auto-Off temporizador é ativado.

 aparece quando o temporizador for desativado pelo sistema de controlo centralizado.

Definições de função

Programação semanal



Operação do botão

1

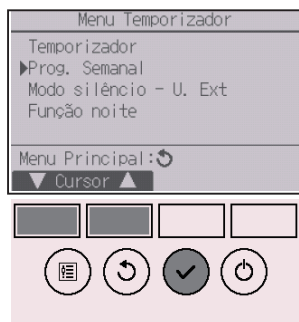

Selecione “Prog. Semanal” no menu do Temporizador e prima o botão **SELECIONAR**.

Programação semanal não irá funcionar nos seguintes casos:

quando On/Off temporizador estiver desativado, quando a Programação semanal estiver desativada, durante um erro, durante uma verificação (no menu de assistência), durante um teste de funcionamento, durante um diagnóstico do controlador remoto, quando o relógio não estiver definido, durante a definição de funções, quando o sistema está controlado centralmente (a operação de On/Off, a definição de temperatura ou a operação do temporizador através do controlo remoto local estão proibidas).

2



As definições atuais irão aparecer.

Prima o botão **F1** ou **F2** para ver as definições para cada dia da semana.

Prima o botão **F3** para ver os padrões 5 a 8.

Prima o botão **F4** para visualizar o estado da Definição 2.

Prima o botão **SELECIONAR** para aceder ao ecrã das definições.

3



Abrir-se-á o ecrã de definições da programação semanal.

Na definição “Acção”, selecione “1” para ativar a definição do temporizador 1 ou selecione “2” para ativar a definição do temporizador 2 com o botão **F3** ou **F4**. Em seguida, prima o botão **SELECIONAR**.

Para verificar os conteúdos das definições 1 ou 2 do temporizador, mova o cursor para “Definição” com o botão **F1** ou **F2** e selecione “1” ou “2” com o botão **F3** ou **F4**.

4



O ecrã de definição da programação semanal irá surgir e as definições atuais serão visualizadas. Por dia, podem ser definidos, no máximo, oito padrões de funcionamento.

Mova o cursor para o dia da semana pretendido com o botão **F1** ou **F2** e prima o botão **F3** para o selecionar. (Pode selecionar vários dias.)

Prima o botão **SELECIONAR**.

Definições de função

5

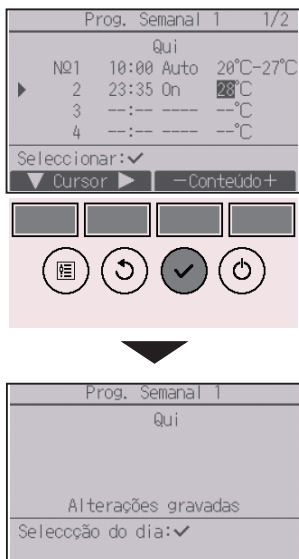

Irá surgir o ecrã de definição dos padrões de funcionamento.

Prima o botão **[F1]** para mover o cursor para o número de padrão pretendido.

Mova o cursor para a hora, On/Off ou temperatura com o botão **[F2]**.

Altere as definições com o botão **[F3]** ou **[F4]**.

- Hora: pode ser definida em incrementos de 5 minutos
- * Prima e mantenha premido o botão para avançar rapidamente os números.
- On/Off/Auto: As definições seleccionáveis dependem do modelo da unidade interna conectada. (Quando um padrão de "Auto" for executado, o sistema irá operar no modo "Auto" (ponto de definição duplo).)
- Temperatura: Os limites de temperatura que podem ser definidos dependem das unidades internas ligadas. (Incrementos de 1°C)

Quando o modo Auto (ponto de definição duplo) está seleccionado, é possível definir duas temperaturas predefinidas. Se um padrão de funcionamento com uma única definição de temperatura predefinida for executado durante o modo Auto (ponto de definição duplo), sua definição será usada como a mesma para a definição de temperatura de arrefecimento no modo Frio.

Prima o botão **[SELECIONAR]** para guardar as definições.

Irá surgir um ecrã de confirmação.

Navegar nos ecrãs

- Para ir para o ecrã de alteração das definições/seleção do dia da semana botão **[SELECIONAR]**
- Para voltar ao Menu principal botão **[MENU]**
- Para voltar ao ecrã anterior botão **[VOLTAR]**



 irá aparecer no Ecran Estado e o Ecran principal no modo Completo quando existir a definição de programação semanal para o dia atual. O ícone não aparecerá enquanto On/Off temporizador estiver ativado ou o sistema estiver sob controlo centralizado (a operação do temporizador através do controlo remoto local está proibida).

Descrição da função

Esta função permite ao utilizador definir os períodos de tempo nos quais é dada prioridade a um funcionamento silencioso de unidades externas em vez do controlo da temperatura. Defina as horas de início e fim de um funcionamento silencioso para cada dia da semana. Seleccione o nível de silêncio pretendido de entre “Intermédio” e “Silencioso”.

Operação do botão

1 Seleccione “Modo silêncio - U. Ext” no menu do Temporizador e prima o botão **SELECIONAR**.



A função “Modo silêncio - U. Ext” está disponível apenas nos modelos que suportam a função.

2 As definições atuais irão aparecer.



Prima o botão **F1** ou **F2** para ver as definições para cada dia da semana.

Prima o botão **SELECIONAR** para aceder ao ecrã das definições.

Definições de função

3

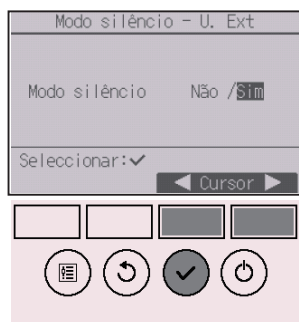

Irá surgir o ecrã para ativar (Sim) e desativar (Não) o modo silencioso.

Para ativar esta definição, mova o cursor para “Sim” com o botão **[F3]** ou **[F4]** e prima o botão **[SELECIONAR]**.

4



Irá surgir o ecrã de definição do Modo silêncio da Unidade Externa.

Para efetuar ou alterar uma definição, mova o cursor para o dia da semana pretendido com o botão **[F1]** ou **[F2]** e prima o botão **[F3]** para o selecionar. (Pode selecionar vários dias.)

Prima o botão **[SELECIONAR]**.

5

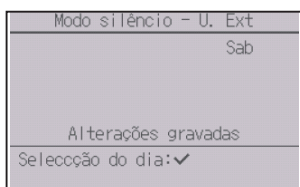

O ecrã de definição irá aparecer.

Mova o cursor para o item pretendido com o botão **F1** ou **F2** de entre Tempo de início, Tempo de fim ou Nível silencioso.

Altere as definições com o botão **F3** ou **F4**.

- Hora de início/fim: pode ser definida em incrementos de 5 minutos
 - * Prima e mantenha premido o botão para avançar rapidamente os números.
- Nível silencioso: Normal, Intermédio, Silêncio



Prima o botão **SELECIONAR** para guardar as definições. Irá surgir um ecrã de confirmação.

Navegar nos ecrãs

- Para ir para o ecrã de alteração das definições/seleção do dia da semana botão **SELECIONAR**
- Para voltar ao Menu principal botão **MENU**
- Para voltar ao ecrã anterior botão **VOLTAR**

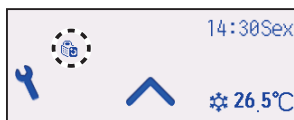

irá aparecer no Ecran Estado e o Ecran prncipal em Modo completo durante o Modo silêncio da Unidade Externa.

Definições de função

Função noite



Descrição da função

Este controlo inicia a operação de aquecimento quando o grupo do objeto de controlo é interrompido e a temperatura ambiente diminui abaixo do limite de temperatura inferior predefinido. Este controlo inicia também a operação de arrefecimento quando o grupo do objeto de controlo é interrompido e a temperatura ambiente aumenta acima do limite de temperatura superior predefinido.

A Função noite não está disponível se a operação e a definição da temperatura forem realizadas com o controlador remoto.

Se a temperatura ambiente é medida pelo sensor da temperatura de sucção do ar condicionado, pode não ser obtida a temperatura exata quando o ar condicionado estiver inativo ou quando o ar não estiver limpo. Neste caso, alterne o sensor para um sensor remoto (PAC-SE40TSA/PAC-SE41TS-E) ou para um sensor de controlo remoto.

Operação do botão

1

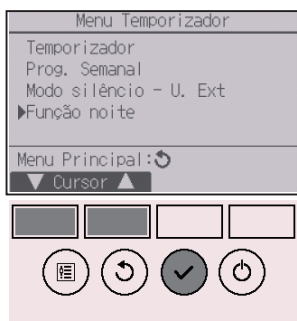

Selecione “Função noite” no menu do Temporizador e prima o botão **SELECIONAR**.

2



As definições atuais irão aparecer.

Prima o botão **SELECIONAR** para aceder ao ecrã das definições.

3

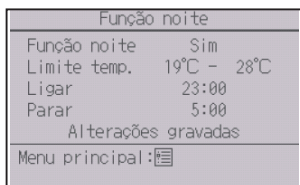

Com o botão **F1** ou **F2**, mova o cursor para o item pretendido de entre Função noite Não (desativar)/ Sim (ativar), Limites de temperatura, Hora de início ou Hora de fim.

Altere as definições com o botão **F3** ou **F4**.

- Limite temp.: Pode ser definida a temperatura limite inferior (para a operação de aquecimento) e a temperatura limite superior (para a operação de arrefecimento). A diferença de temperatura entre os limites inferior e superior deve ser de 4°C (8°F) ou mais. Os limites de temperatura que podem ser definidos dependem das unidades internas ligadas.
 - * Incrementos de 1°C
- Hora de início/fim: pode ser definida em incrementos de 5 minutos
 - * Prima e mantenha premido o botão para avançar rapidamente os números.

Prima o botão **SELECIONAR** para guardar as definições.

Irá surgir um ecrã de confirmação.

Navegar nos ecrãs

- Para voltar ao Menu principal botão **MENU**
- Para voltar ao ecrã anterior botão **VOLTAR**

Definições de função



☰ irá aparecer no irá aparecer no Ecran Estado e o Ecran principal em Modo completo quando a Função noite é ativada.

☰ aparece quando o temporizador for desativado pelo sistema de controlo centralizado.

A Função noite não irá funcionar nos seguintes casos:

Quando a unidade estiver em funcionamento, quando a Função noite estiver desativada, durante um erro, durante uma verificação (no menu de assistência), durante um teste de funcionamento, durante um diagnóstico do controlador remoto, quando o relógio não estiver definido, durante a definição de funções, quando o sistema está controlado centralmente (a operação de On/Off, a definição de temperatura ou a operação do temporizador através do controlo remoto local estão proibidas).

Definir as restrições dos limites de temperatura

Operação do botão

1



Selecione “Poupança energética” no Menu principal (consulte a página 24) e prima o botão **SELECIONAR**.

2

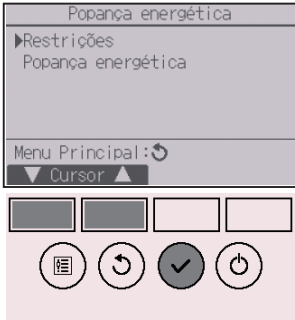

Mova o cursor para “Restrições” com o botão **F1** ou **F2** e prima o botão **SELECIONAR**.

Definições de função

3



As definições atuais irão aparecer.

Mova o cursor para “Limites Temp.” com o botão **F1** ou **F2** e prima o botão **SELECIONAR**.

4



Irá surgir o ecrã para definir os limites de temperatura.

Mova o cursor para o item pretendido com o botão **F1** de entre “Limites Temp.”, “Frio·Desum.”, “Calor” ou “Auto”.

5

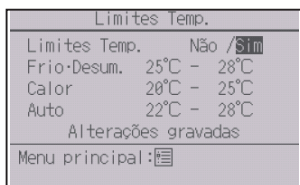

Altere as definições com o botão **[F3]** ou **[F4]**.

- Limites Temp.: Não (não restringidos) ou Sim (restringidos)
- Frio·Desum.: Limite superior e inferior da temperatura (incrementos de 1°C)
- Calor: Limite superior e inferior da temperatura (incrementos de 1°C)
- Auto: Limite superior e inferior da temperatura (incrementos de 1°C)

Limites de definição da temperatura

Modo	Limite inferior	Limite superior
Frio·Desum. *1	19 ~ 30°C (67 ~ 87°F)	30 ~ 19°C (87 ~ 67°F)
Calor *2 *3	17 ~ 28°C (63 ~ 83°F)	28 ~ 17°C (83 ~ 63°F)
Auto *4	19 ~ 28°C (67 ~ 83°F)	28 ~ 19°C (83 ~ 67°F)

* Os limites que podem ser definidos variam consoante a unidade ligada.

*1 Os limites de temperatura para os modos Frio, Desumidificação e Auto (ponto de definição duplo) podem ser definidos.

*2 Os limites de temperatura para os modos Calor e Auto (ponto de definição duplo) podem ser definidos.

*3 Os limites de temperatura para os modos Calor, Frio e Desumidificação devem respeitar as condições abaixo:

- Limite máximo para arrefecimento - limite máximo para aquecimento ≥ Diferença de temperatura mínima (varia de acordo com o modelo da unidade interna)
- Limite mínimo para arrefecimento - limite mínimo para aquecimento ≥ Diferença de temperatura mínima (varia de acordo com o modelo da unidade interna)

*4 Os limites de temperatura para o modo Auto (ponto de definição único) podem ser definidos.

Prima o botão **[SELECIONAR]** para guardar as definições.

Irá surgir um ecrã de confirmação.

Navegar nos ecrãs

- Para voltar ao Menu principal botão **[MENU]**
- Para voltar ao ecrã anterior botão **[VOLTAR]**



irá aparecer no irá aparecer no Ecran Estado e o Ecran principal em Modo completo quando os limites de temperatura são restringidos.

Definições de função

Restrições

P

Função de operação bloqueada

Para ativar a função de operação bloqueada, defina o item "Operação Bloqueada" para "Sim".

Operação do botão

1



Invoque o ecrã de definição de Restrições. (Consulte a página 43.)

Mova o cursor para "Operação Bloqueada" e prima o botão **SELECIONAR**.

2

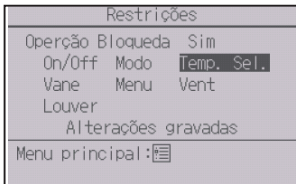

Irá aparecer o ecrã para efetuar as definições para a função de operação bloqueada.

Mova o cursor para o item pretendido com o botão **[F1]** ou **[F2]** de entre “Operação Bloqueada”, “Local”, “On/Off”, “Modo”, “Temp. Sel.”, “Menu”, “Vent”, “Louver” ou “Vane”.

Altere as definições com o botão **[F3]** ou **[F4]**.

- Operação Bloqueada: Não (desativar)/Sim (ativar)
- Local: “Indiv.” ou “Hotel”
- On/Off: Operação On/Off
- Modo: Definição do modo de funcionamento “-” / “Bloqueado”
- Temp. Sel.: Definição da temperatura predefinida
- Vane: Definição da “vane”
- Menu: Definição de menu
- Vent: Definição da velocidade da ventoinha
- Louver: Definição do louver

Selecionando-se “Hotel” para a definição de “Local”, as operações seguintes serão automaticamente bloqueadas: Modo, Vane, Menu e Louver.

Prima o botão **[SELECIONAR]** para guardar as definições.

Irá surgir um ecrã de confirmação.

Navegar nos ecrãs

- Para voltar ao Menu principal botão **[MENU]**
- Para voltar ao ecrã anterior botão **[VOLTAR]**

Definições de função



irá aparecer no irá aparecer no Ecran Estado e o Ecran principal em Modo completo quando a definição da função de operação bloqueada está ativada.

O guia de operações que corresponde à função bloqueada será suprimido.

Para mostrar o menu principal enquanto a definição de menu está bloqueada, mantenha o botão **Definição** pressionado durante dez segundos ou mais. Introduza a password de administrador no ecrã de introdução da password.

Poupança energética



Regresso automático à temperatura predefinida

Se, depois de a função Auto ser ativada, alterar o modo de funcionamento ou efetuar a operação ON/OFF a partir deste controlador remoto, a temperatura definida regressa automaticamente à temperatura necessária independentemente do tempo definido.

Operação do botão

1

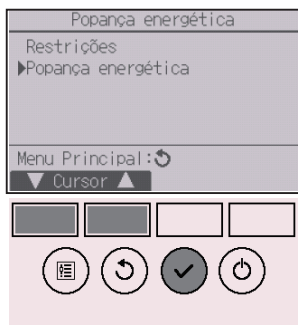

Selecione “Poupança energética” no Menu de poupança energética e prima o botão **[SELECIONAR]**.

2



As definições atuais irão aparecer.

Mova o cursor para “Auto” com o botão **[F1]** ou **[F2]** e prima o botão **[SELECIONAR]**.

Definições de função

3



Irá aparecer o ecrã para efetuar as definições de retorno automático para a temperatura predefinida.

Mova o cursor para o item pretendido com o botão **[F1]** ou **[F2]** de entre “Auto”, “Frio” ou “Calor.”

4



Altere as definições com o botão **[F3]** ou **[F4]**.

- Auto: Não (desativar)/Sim (ativar)
- Frio: A definição do limite do temporizador é de 30 a 120 minutos em incrementos de 10 minutos.
A definição dos limites de temperatura é de 19°C a 30°C (67 a 87°F) (Incrementos de 1°C).
- Calor: A definição do limite do temporizador é de 30 a 120 minutos em incrementos de 10 minutos.
A definição dos limites de temperatura é de 17°C a 28°C (63 a 83°F) (Incrementos de 1°C).

Prima o botão **[SELECIONAR]** para guardar as definições. “Frio” inclui os modos “Desumidificação” e “Auto Frio” e “Calor” inclui o modo “Auto Calor”.

Irá surgir o ecrã que lhe permite definir o item selecionado.

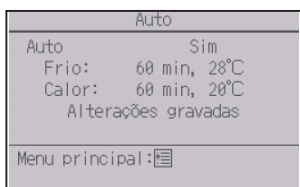

Navegar nos ecrãs

- Para voltar ao Menu principal botão **[MENU]**
- Para voltar ao ecrã anterior botão **[VOLTAR]**

As definições da temperatura predefinida ou do temporizador não entrarão em vigor quando os limites de temperatura estiverem restringidos e quando o sistema estiver a ser controlado centralmente (quando a definição dos limites de temperatura pelo controlador local está proibida). Quando o sistema está a ser controlado centralmente (quando a operação do temporizador através do controlador remoto local está proibida), apenas as definições do temporizador ficarão sem efeito.

Poupança energética



Definir o horário do funcionamento em Poupança energética

Operação do botão

1



Invoque o ecrã “Poupança energética”. (Consulte a página 49.)

Mova o cursor para “Horário” e prima o botão **SELECIONAR**.

2



Irá surgir o ecrã que lhe permite ver o horário.

Prima o botão **F1** ou **F2** para ver as definições para cada dia da semana.

Prima o botão **SELECIONAR** para aceder ao ecrã das definições.

3

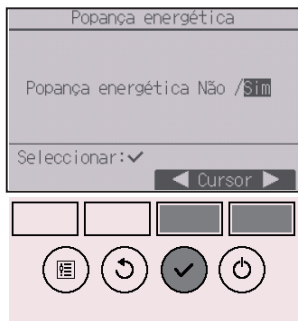

Irá surgir o ecrã para ativar (Sim)/desativar (Não) o horário do funcionamento em poupança energética.

Selecione “Não” ou “Sim” com o botão **F3** ou **F4**.

Prima o botão **SELECIONAR** para aceder ao ecrã de alteração das definições/seleção do dia da semana.

Definições de função

4



Irá surgir o ecrã de alteração das definições/seleção do dia da semana.

Podem ser definidos por dia um máximo de quatro padrões de funcionamento.

Mova o cursor para o dia da semana pretendido com o botão [F1] ou [F2] e prima o botão [F3] para o seleccionar. (Pode seleccionar vários dias.)

Prima o botão [SELECIONAR] para aceder ao ecrã da definição de padrão.

5



O ecrã da definição de padrão irá aparecer.

Prima o botão [F1] para mover o cursor para o número de padrão pretendido.

Mova o cursor para o item pretendido com o botão [F2] de entre a hora de início, a hora de fim e a taxa de poupança energética (disposto por esta ordem a partir da esquerda).

Altere as definições com o botão [F3] ou [F4].

- Hora de início/fim: pode ser definida em incrementos de 5 minutos

- * Prima e mantenha premido o botão para avançar rapidamente os números.
- Taxa de poupança energética: A definição do limite é de 0% e 50 a 90% em incrementos de 10%.

Prima o botão [SELECIONAR] para guardar as definições.

Irá surgir um ecrã de confirmação.

Quanto mais baixo for o valor, maior é o efeito de poupança energética.



irá aparecer no irá aparecer no Ecran Estado e o Ecran prncipal no modo Completo quando a unidade está a funcionar no modo de poupança energética.

Navegar nos ecrãs

- Para ir para o ecrã de alteração das definições/seleção do dia da semana botão **SELECIONAR**
- Para voltar ao Menu principal botão **MENU**
- Para voltar ao ecrã anterior botão **VOLTAR**

Definições de função

Relógio



Operação do botão

1



Selecione “Programação inicial” no Menu principal (consulte a página 24) e prima o botão **SELECIONAR**.

A definição do relógio é necessária antes de efetuar as definições seguintes.

- On/Off temporizador
- Programação Semanal
- Modo silêncio da Unidade Externa
- Poupança energética
- Função noite

Se um determinado sistema não estiver equipado com controladores do sistema, o tempo do relógio não será corrigido automaticamente. Neste caso, corrija periodicamente o tempo do relógio.

2

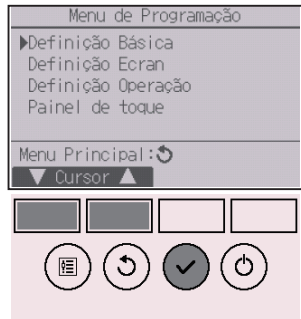

Mova o cursor para “Definição Básica” com o botão **F1** ou **F2** e prima o botão **SELECIONAR**.

3



Selecione “Relógio” com o botão **F1** ou **F2** e prima o botão **SELECIONAR**.

4



Mova o cursor para “Relógio” com o botão **F1** ou **F2** e prima o botão **SELECIONAR**.

5



Mova o cursor para o item pretendido com o botão **F1** ou **F2** de entre ano, mês, data, hora ou minuto. Aumente ou diminua o valor do item selecionado com o botão **F3** ou **F4** e prima o botão **SELECIONAR**. Irá surgir um ecrã de confirmação.

Navegar nos ecrãs

- Para voltar ao Menu principal botão **MENU**
- Para voltar ao ecrã anterior botão **VOLTAR**

Definições de função

Hora de verão



Descrição da função

É possível definir a hora de início/hora de fim para a Hora de Verão. A função de Hora de Verão será ativada com base nos conteúdos das definições.

- Se um determinado sistema estiver equipado com um controlador do sistema, desative esta definição para manter o tempo de correção.
- No início e no fim da hora de verão, o temporizador pode entrar em funcionamento duas vezes ou pode não entrar em funcionamento.
- Esta função entrará em funcionamento apenas se o relógio tiver sido definido.

Operação do botão

1

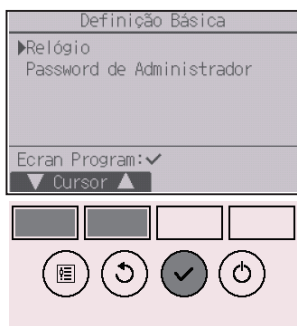

Selecione “Relógio” no menu de Definição Básica e prima o botão **SELECIONAR**.

2



Mova o cursor para “Hora de Verão” com o botão **F1** ou **F2** e prima o botão **SELECIONAR**.

3



Mova o cursor para os itens seguintes com o botão **F1** para efetuar as definições.

- **DST**
Selecione “Não” (desativar) ou “Sim” (ativar) com o botão **F2**. A predefinição é “Não”.
- **Data(Início)*1**
Defina o dia da semana, o número da semana e o mês com o botão **F3** ou **F4**. A predefinição é “Dom/5.ª/Mar”.
- **Hora de início**
Defina a hora de início para a Hora de verão com o botão **F3** ou **F4**.
- **Avançar para**
Defina o momento em que o relógio deve ser adiantado para a hora de início acima com o botão **F3** ou o botão **F4**.
- **Data(Fim)*1 (2.ª página)**
Defina o dia da semana, o número da semana e o mês com o botão **F3** ou **F4**. A predefinição é “Dom/5.ª/Out”.
- **Hora de fim (2.ª página)**
Defina a hora de fim para a Hora de verão com o botão **F3** ou **F4**.
- **Recurar para (2.ª página)**
Defina o momento em que o relógio deve ser atrasado para a hora de fim acima com o botão **F3** ou o botão **F4**.

*1 Se seleccionar “5.ª” para o número da semana e a 5.ª semana não existir no mês selecionado, a definição será considerada como sendo a “4.ª”.

Prima o botão **SELECIONAR** para guardar as definições.

Irá surgir um ecrã de confirmação.

Navegar nos ecrãs

- Para voltar ao Menu principal botão **MENU**
- Para voltar ao ecrã anterior botão **VOLTAR**

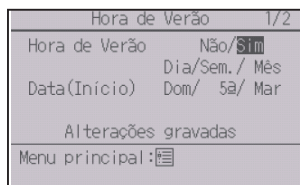

Definições de função

Ecran principal



Operação do botão

1

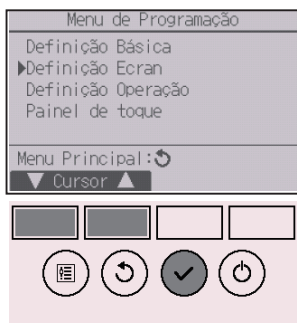

Selecione “Definição Ecran” no menu de Programação inicial e prima o botão **SELECIONAR**.

2



Mova o cursor para “Ecran principal” com o botão **F1** ou **F2** e prima o botão **SELECIONAR**.

3



Selecione “Completo” ou “Básico” (consulte a página 10) com o botão **F3** ou **F4** e prima o botão **SELECIONAR**.

Irá surgir um ecrã de confirmação.

Navegar nos ecrãs

- Para voltar ao Menu principal botão **MENU**
- Para voltar ao ecrã anterior botão **VOLTAR**

Operação do botão

1

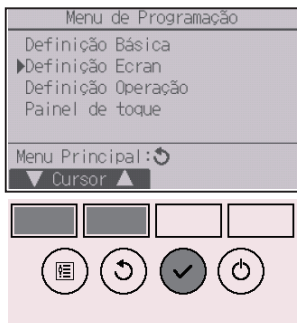

Selecione “Definição Ecran” no menu de Programação inicial e prima o botão **SELECIONAR**.

2



Mova o cursor para “Ecran principal” com o botão **F1** ou **F2** e prima o botão **SELECIONAR**.

3



Selecione “Explic. íconeo” com o botão **F1** ou **F2**, selecione a definição “Sim” ou “Não” pretendida com o botão **F3** ou **F4** e prima o botão **SELECIONAR**. A predefinição é “Sim”.

Navegar nos ecrãs

- Para voltar ao Menu principal botão **MENU**
- Para voltar ao ecrã anterior botão **VOLTAR**

Definições de função

4

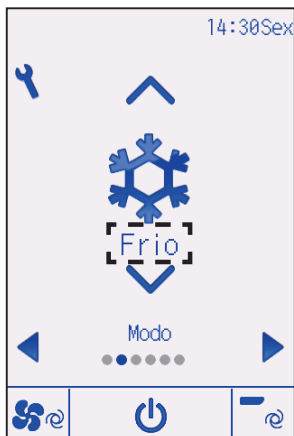

Ao seleccionar “Sim”, a explicação sobre o ícone do item de definição aparece como se mostra à esquerda.

Operação do botão

1

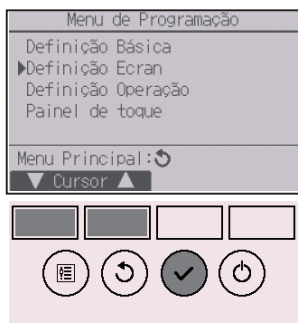

Selecione “Definição Ecran” no menu de Programação inicial e prima o botão **SELECIONAR**.

2



Mova o cursor para “Brilho” com o botão **F1** ou **F2** e prima o botão **SELECIONAR**.

3



Ajuste o brilho com o botão **F1** ou **F2**.
Pode seleccionar-se “On” ou “Off” para a definição “Mant aceso” com o botão **F4**.

Quando “On” é seleccionado a retroiluminação vai permanecer ligeiramente ligada após o tempo especificado ter decorrido.

Navegar nos ecrãs

- Para voltar ao Menu principal botão **MENU**
- Para voltar ao ecrã anterior botão **VOLTAR**

Definições de função

Seleção do idioma



Descrição da função

O idioma pretendido pode ser definido. As opções de idioma são inglês, francês, alemão, espanhol, italiano, português, sueco, russo, grego, turco, neerlandês, checo, húngaro e polaco.

Operação do botão

1

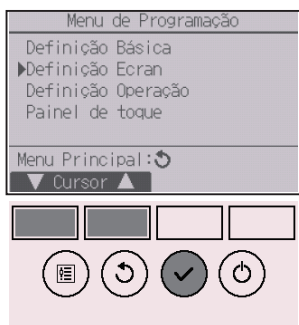

Selecione “Definição Ecran” no menu de Programação inicial e prima o botão **SELECIONAR**.

2



Mova o cursor para “Seleção da linguagem” com o botão **F1** ou **F2** e prima o botão **SELECIONAR**.

3

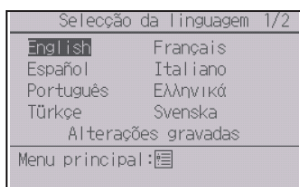

Mova o cursor para o idioma pretendido com os botões **F1** a **F4** e prima o botão **SELECIONAR** para guardar a definição.

Quando a alimentação for ligada pela primeira vez, aparecerá o ecrã Seleção do idioma. Selecione o idioma pretendido. O sistema não irá iniciar se o idioma não for selecionado.

Irá surgir um ecrã que indica que a definição foi guardada.

Navegar nos ecrãs

- Para voltar ao Menu principal botão **MENU**
- Para voltar ao ecrã anterior botão **VOLTAR**

Definições de função

Design



Operação do botão

1

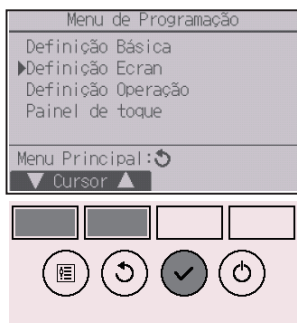

Selecione “Definição Ecran” no menu de Programação inicial e prima o botão **SELECIONAR**.

2

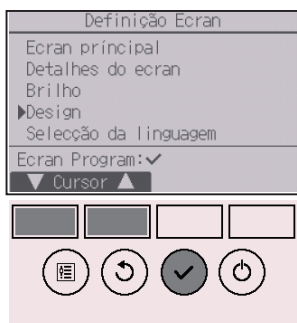

Mova o cursor para “Design” com o botão **F1** ou **F2** e prima o botão **SELECIONAR**.

3



Selecione “Cor” com o botão **F4**.

- Cor: A cor do ecran pode ser selecionada. (Consulte a página seguinte.)
- Branco: Ecran monocromático (base branca)
- Preto: Ecran monocromático (base preta)

Depois de selecionar “Branco” ou “Preto”, prima o botão **SELECIONAR**. Quando estiver selecionado “Cor”, escolha a cor pretendida consultando a página seguinte.

4



Selecione o item seguinte com o botão **[F1]** ou **[F2]** e defina a cor de ecrã desejada para cada item.

- Tonalidade: Defina a tonalidade com o botão **[F3]** ou **[F4]**. (Os limites que podem ser definidos vão de -90 a 89.)
- Padrão: Defina a cor com o botão **[F4]**.
- Cor def. para: Selecione "Carácter" ou "Fundo" como destino ao qual será aplicada a cor com o botão **[F4]**.

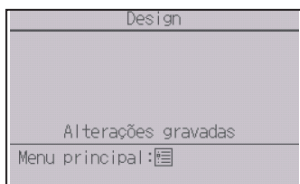

O exemplo de cor por baixo dos botões de função variará conforme a definição.

Defina a cor pretendida e prima o botão **[SELECIONAR]**.

Navegar nos ecrãs

- Para voltar ao Menu principal botão **[MENU]**
- Para voltar ao ecrã anterior botão **[VOLTAR]**

Definições de função

Calibração do painel de toque



Operação do botão

1

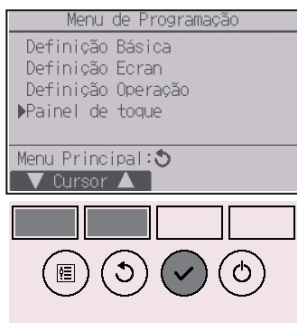

Selecione “Painel de toque” no menu de Programação inicial e prima o botão **SELECIONAR**.

2

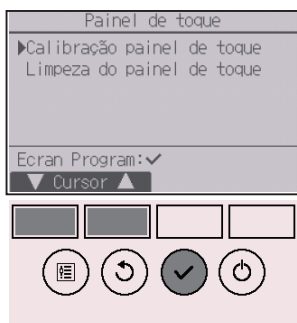

Mova o cursor para “Calibração do painel de toque” com o botão **F1** ou **F2** e prima o botão **SELECIONAR**.

3

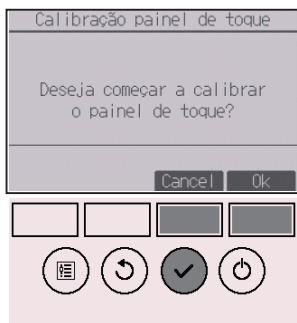

Irá surgir um ecrã de confirmação. Selecione “Cancelar” ou “Ok” com o botão **F3** ou **F4** e prima o botão **SELECIONAR**.

4

Toque nos pontos pretos pela ordem por que aparecem no ecrã. Deverão ser nove no total.

Toque nos pontos pretos com uma caneta de toque no período de um minuto, começando no canto superior esquerdo.

Toque nos nove pontos pretos pela ordem por que aparecem no ecrã.

Depois de tocar em todos os nove pontos, a calibração está completa e o ecrã retrocede para o menu do painel de toque.

- Se não se tocar no painel de toque por um minuto, a calibração será cancelada e o ecrã regressará automaticamente ao ecrã anterior.
- Para calibrar adequadamente o painel de toque, use um objeto pontiagudo, mas não afiado, para tocar nos pontos.
 - * Um objeto afiado poderá danificar ou riscar o painel de toque.

Definições de função

Limpeza do painel de toque



Operação do botão

1

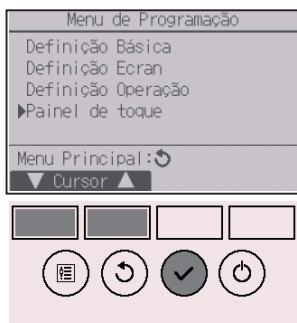

Selecione “Painel de toque” no menu de Programação inicial e prima o botão **SELECIONAR**.

2

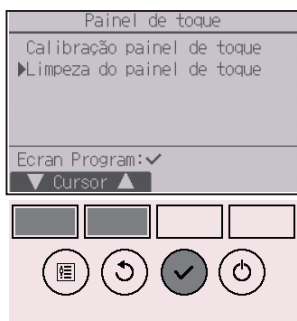

Mova o cursor para “Limpeza do painel de toque” com o botão **F1** ou **F2** e prima o botão **SELECIONAR**.

3

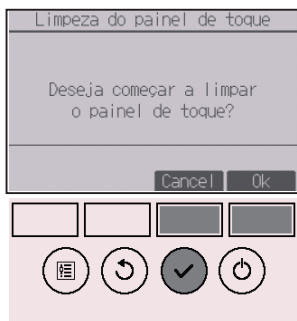

Irá surgir um ecrã de confirmação. Selecione “Cancelar” ou “Ok” com o botão **F3** ou **F4** e prima o botão **SELECIONAR**.

4

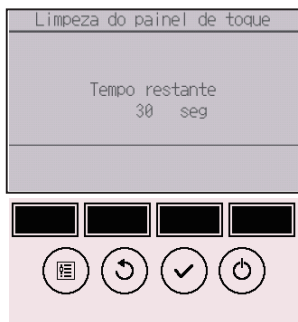

Este ecrã concede 30 segundos ao utilizador para que limpe o painel de toque sem alterar as definições acidentalmente.

Decorridos os 30 segundos, o ecrã regressa ao menu do painel de toque.

- Limpe com um pano macio seco, um pano embebido em água com detergente suave ou um pano humedecido em etanol. Não use solventes ácidos, alcalinos ou orgânicos.

Definições de função

Restaurar controlador remoto



Descrição da função

É possível restaurar o controlador remoto para o estado em que é fornecido de fábrica. Tenha em conta que serão restaurados os dados seguintes.

O controlador remoto inicia automaticamente depois de ter sido restaurado.

Definição do temporizador, Definição da programação semanal, Definição do modo silêncio da unidade externa, Definição da poupança energética, Definição da opção de poupança de energia, Definição do relógio, Definição da hora de verão, Definição do Ecran principal, Definição do brilho, Definição dos detalhes do ecrã, Definição do design, Definição do modo automático, Definição do nome do modelo, Definição do n.º de série, Definição da informação de assistência, Informação de erro, Password de administrador, Password de manutenção

Operação do botão

1

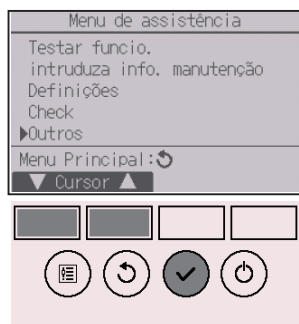

Selecione “Outros” no menu de Assistência e prima o botão **[SELECIONAR]**.

2

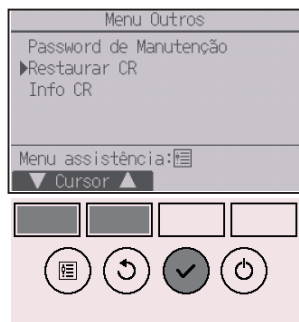

Mova o cursor para “Restaurar CR” com o botão **[F1]** ou **[F2]** e prima o botão **[SELECIONAR]**.

3



Selecione “Ok” com o botão **F4**.

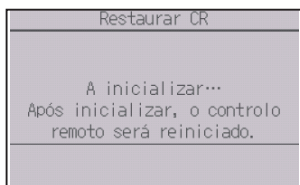

O controlador remoto inicia automaticamente depois de ter sido restaurado.

Definições de função

Informação do controlador remoto



Descrição da função

A informação do controlador remoto em utilização pode ser verificada.

Operação do botão

1

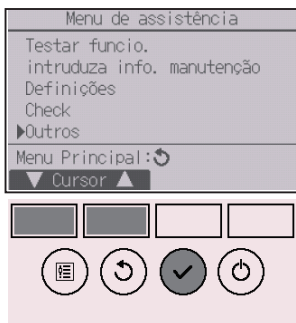

Selecione “Outros” no menu de Assistência e prima o botão **SELECIONAR**.

2



Mova o cursor para “Info CR” com o botão **F1** ou **F2** e prima o botão **SELECIONAR**.

3

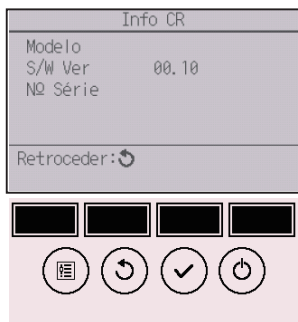

Podem verificar-se o nome do modelo, a versão de software e o número de série do controlador remoto em utilização.

Resolução de problemas

Informação de erro

Se ocorrer um erro, ver-se-á o ecrã seguinte e o LED de operação ficará intermitente. Verifique o estado do erro, interrompa o funcionamento e consulte o seu assistente.

Operação do botão

1

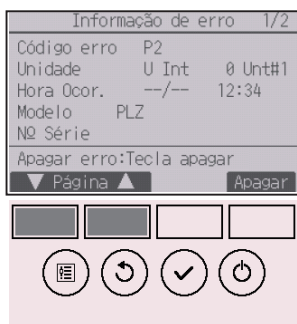

Irão ser apresentados o código do erro, unidade do erro, endereço do refrigerante, nome do modelo da unidade, data e hora a que ocorreu um erro e o número de série.

O nome do modelo e o número de série irão aparecer apenas se as informações tiverem sido registadas.

Prima o botão **[F1]** ou **[F2]** para ir para a página seguinte.

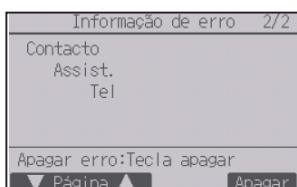

As informações de contacto (número de telefone do assistente) irão aparecer se as informações tiverem sido registadas.

2

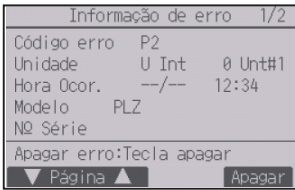

Prima o botão **[F4]** ou o botão **[LIGAR/DESLIGAR]** para apagar o erro que está a ocorrer.

Os erros não podem ser apagados enquanto a operação ON/OFF for proibida.

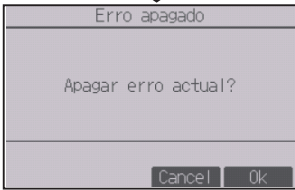
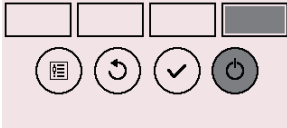

Selecione "Ok" com o botão **[F4]**.

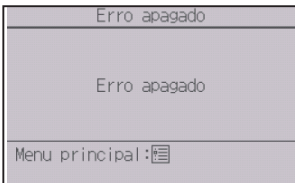
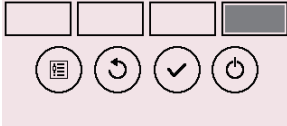

Irá surgir um ecrã de confirmação.

Navegar nos ecrãs

- Para voltar ao Menu principal botão **[MENU]**

Resolução de problemas

Verificar a informação do erro



Enquanto não ocorrerem erros, a página 2/2 das informações do erro (consulte a página 74) pode ser visualizada no funcionamento por menus. Selecione menu “Manutenção” no Menu principal e prima o botão **SELECIONAR**.

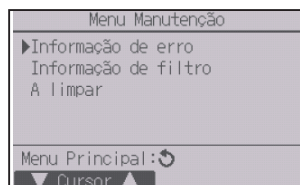

Para visualizar o ecrã de informação de erro, selecione “Informação de erro” no menu Manutenção. Os erros não podem ser apagados.

Off auto por não ocupação

Quando a unidade deixa de funcionar devido à função Off auto por não ocupação da opção de poupança de energia, irá surgir o ecrã seguinte para o modelo do painel 3D i-See sensor.

Consulte o Livro de Instruções da unidade interna para obter informações sobre a definição 3D i-See sensor.

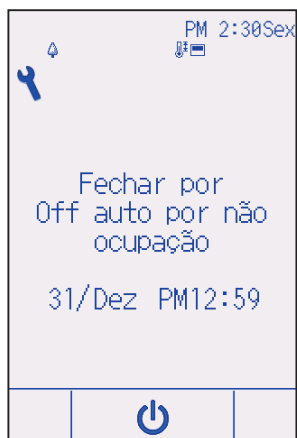

Manutenção

Informação de filtro



 irá aparecer no Ecran Estado e o Ecran principal no modo Completo quando tiver de limpar os filtros.

Lave, limpe ou substitua os filtros quando surgir este sinal.

Consulte o Manual de Instruções da unidade interna para obter mais detalhes.

Operação do botão

1

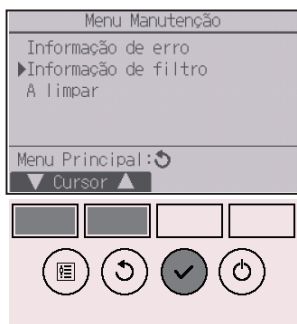

Selecione "Informação de filtro" no menu Manutenção e prima o botão **SELECIONAR**.

2

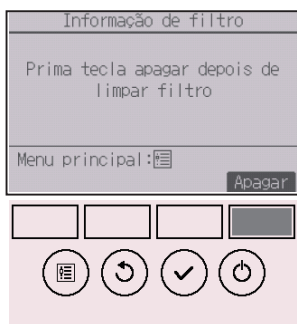

Prima o botão **F4** para apagar o símbolo do filtro. Consulte o Manual de Instruções da unidade interna para saber como limpar o filtro.

3

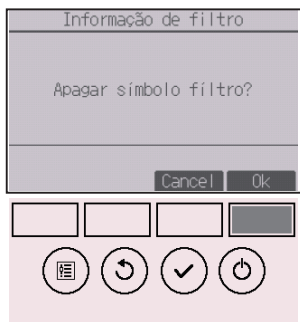

Selecione “Ok” com o botão **[F4]**.

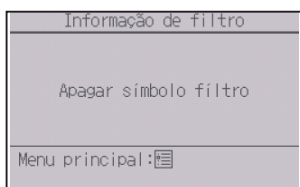

Irá surgir um ecrã de confirmação.

Navegar nos ecrãs

- Para voltar ao Menu principal botão **[MENU]**
- Para voltar ao ecrã anterior botão **[VOLTAR]**



Quando  é mostrado no Ecran Estado e o Ecran principal aparece em modo Completo, o sistema está a ser controlado centralmente e o símbolo do filtro não pode ser apagado.

Se duas ou mais unidades internas estiverem ligadas, o tempo de limpeza do filtro para cada unidade poderá ser diferente, dependendo do tipo de filtro.

O ícone  ficará visível quando o filtro na unidade principal estiver pronto para ser limpo. Quando o símbolo do filtro for apagado, o tempo acumulado do funcionamento de todas as unidades será reiniciado.

O ícone  está programado para aparecer após uma determinada duração do funcionamento, partindo do princípio de que as unidades internas estão instaladas num espaço com uma qualidade de ar normal. Dependendo da qualidade do ar, o filtro poderá necessitar de uma limpeza com maior frequência.

O tempo acumulado no qual o filtro necessita de limpeza depende do modelo.

Especificações

Especificações do controlador

	Especificação
Tamanho do produto	Standard (PAR-CT01MAA(R)-SB/PAR-CT01MAA-S): 65 (L) × 120 (A) × 14,1 (P) mm (2 9/16 × 4 23/32 × 9/16 [pol]) (não incluindo a parte saliente)
	Premium (PAR-CT01MAA(R)-PB): 68 (L) × 120 (A) × 14,1 (P) mm (2 11/16 × 4 23/32 × 9/16 [pol]) (não incluindo a parte saliente)
Peso líquido	Standard (PAR-CT01MAA(R)-SB/PAR-CT01MAA-S): 0,09 kg (13/64 lbs)
	Premium (PAR-CT01MAA(R)-PB): 0,10 kg (7/32 lbs)
Tensão de alimentação nominal	12 VCC (fornecida a partir das unidades internas)
Consumo de energia	0,6 W
Ambiente de utilização	Temperatura 0 ~ 40°C (32 ~ 104°F) Humidade 25 ~ 90% HR (sem ponto de condensação)
Material	Standard (PAR-CT01MAA(R)-SB/PAR-CT01MAA-S) Corpo principal: ABS
	Premium (PAR-CT01MAA(R)-PB) Corpo principal: ABS Painel lateral: Alumínio

Lista de funções (a partir de 1 de outubro de 2017)

○ : Suportado × : Não suportado

	Função	CITY MULTI	Mr. SLIM	Password solicitada
Energia	ON/OFF	○	○	-
Definições	Modo de funcionamento	○	○	-
	Modo Auto (ponto de definição duplo)	○	○	-
	Temperatura predefinida	○	○	-
	Velocidade da ventoinha	○	○	-
	Vane	○	○	-
	Louver	○	○	-
	Ventilação	○	○	-
Menu de Operação	Função turbo	×	○	-
	Ângulo "vane" manual	○	○	-
	3D i-See sensor	○	○	-
Menu de temporizador	Temporizador (On/Off temporizador)	○	○	administrador
	Temporizador (Auto-Off temporizador)	○	○	administrador
	Programação semanal	○	○	administrador
	Modo silêncio da Unidade Externa	○	○	administrador
	Função noite	○	○	administrador
Menu de poupança energética	Restrição dos limites da temperatura	○	○	administrador
	Função de operação bloqueada	○	○	administrador
	Auto	○	○	administrador
	Horário	×	○	administrador
Menu de programação inicial	Relógio	○	○	administrador
	Definição do formato de visualização do relógio	○	○	administrador
	Hora de verão	○	○	administrador
	Ecran principal	○	○	administrador
	Explicação sobre os ícones	○	○	administrador
	Brilho	○	○	administrador
	Seleção do idioma	○	○	administrador
	Design	○	○	administrador
	Calibração do painel de toque	○	○	administrador
	Limpeza do painel de toque	○	○	administrador
Password (Administrador)	○	○	administrador	
Menu de assistência	Restaurar controlador remoto	○	○	manutenção
	Informação do controlador remoto	○	○	manutenção
	Teste de funcionamento	○	○	manutenção
	Introdução de informações sobre o modelo	○	○	manutenção
	Introdução de informações sobre o assistente	○	○	manutenção
	Função programação	○	○	manutenção
	Plano de manutenção	×	○	manutenção
	Password (Manutenção)	○	○	manutenção
Menu Manutenção	Descer painel auto	○	○	-
	Informação de erro	○	○	-
	Informação de filtro	○	○	-

* As funções suportadas variam consoante o modelo da unidade.

Especificações

Lista de funções que podem/não podem ser utilizadas em conjunto

	Função turbo	On/Off temporizador	Auto-Off temporizador	Programação semanal	Modo silêncio da Unidade Externa	Limites de temperatura	Operação bloqueada	Auto	Horário da poupança energética	Função noite
Função turbo		○	○	○	△ 1	○	△ 2	○	△ 1	○
On/Off temporizador	○		○	× 1	○	○	○	○	○	△ 3
Auto-Off temporizador	○	○		○	○	○	○	○	○	△ 4
Programação semanal	○	× 1	○		○	○	○	○	○	△ 5
Modo silêncio da Unidade Externa	△ 1	○	○	○		○	○	○	○	○
Limites de temperatura	○	○	○	○	○		○	× 2	○	△ 6
Operação bloqueada	△ 2	○	○	○	○	○		○	○	○
Auto	○	○	○	○	○	× 2	○		○	△ 7
Horário da poupança energética	△ 1	○	○	○	○	○	○	○		○
Função noite	○	△ 3	△ 4	△ 5	○	△ 6	○	△ 7	○	

○ : Pode ser utilizada em conjunto

× : Não pode ser utilizada em conjunto

△ : Restringida

△ 1: Esta função é ativada depois de concluída a operação da função turbo, uma vez que esta tem maior prioridade.

△ 2: Esta função não pode ser utilizada se alguma operação estiver bloqueada.

△ 3: A função noite não pode ser utilizada quando a unidade estiver a funcionar na definição On/Off temporizador.

△ 4: A função Auto-off não pode ser utilizada para a Função noite.

△ 5: A função noite não pode ser utilizada quando a unidade estiver a funcionar na definição Programação Semanal.

△ 6: A definição dos limites da temperatura não pode ser utilizada para a função noite.

△ 7: A função Auto não pode ser utilizada para a função noite.

× 1: A definição Programação Semanal não é eficaz porque On/Off temporizador tem maior prioridade.

× 2: A função Auto não pode ser utilizada porque a definição dos limites da temperatura tem maior prioridade.

Σύστημα ελέγχου CITY MULTI
και κλιματιστικά Mr. SLIM της Mitsubishi

Τηλεχειριστήριο Αφής MA

PAR-CT01MAA-PB

PAR-CT01MAA-SB

PAR-CT01MAA-S

PAR-CT01MAR-PB

PAR-CT01MAR-SB

Ελληνικά

Βιβλίο Οδηγιών



Πριν από τη χρήση, διαβάστε προσεκτικά τις οδηγίες σε αυτό το εγχειρίδιο για να χρησιμοποιήσετε σωστά το προϊόν.

Φυλάξτε τες για μελλοντική αναφορά.



Φροντίστε να παραδοθεί αυτό το CD-ROM και το Εγχειρίδιο εγκατάστασης στον εκάστοτε μελλοντικό χρήστη. Για να διασφαλιστεί η ασφαλής και η σωστή λειτουργία του τηλεχειριστηρίου, θα πρέπει να εγκατασταθεί μόνο από εξειδικευμένο προσωπικό.

Περιεχόμενα

Προφυλάξεις ασφαλείας	4
Εξαρτήματα του τηλεχειριστηρίου	6
Διασύνδεση τηλεχειριστηρίου - Οθόνη κατάστασης/Κύρια οθόνη	6
Διασύνδεση τηλεχειριστηρίου - Οθόνη μενού	8
Οθόνη - Οθόνη κατάστασης/Κύρια οθόνη	10
Διάρθρωση των μενού και εικονίδια	12
Διάρθρωση των μενού	12
Επεξήγηση εικονιδίων	15
Βασικές λειτουργίες	16
Ενεργοποίηση/Απενεργοποίηση (ON/OFF)	16
Ρυθμίσεις κατάστασης λειτουργίας, θερμοκρασίας, ταχύτητας ανεμιστήρα, περσίδας, γρίλιας και εξαερισμού (Lossnay)	17
Πλοήγηση στα μενού	22
Λίστα Κύριου μενού	22
Πλοήγηση στο Κύριο μενού	24
Ρυθμίσεις λειτουργίας	25
Ισχυρό	25
Χειροκίνητη γωνία περσίδας	26
Χρονοδιακόπτης (Χρονοδιακόπτης On/Off)	29
Χρονοδιακόπτης (Χρονοδιακόπτης Αυτόματου Off)	32
Εβδομαδιαίος χρονοδιακόπτης	34
Αθόρυβη λειτουργία εξωτερικής μονάδας	37
Νυχτερινή λειτουργία	40
Περιορισμός	43
Εξοικονόμηση ενέργειας	49
Ρολόι	54
Θερινή ώρα	56
Κύρια οθόνη	58
Επεξήγηση εικονιδίων	59
Φωτεινότητα	61
Επιλογή γλώσσας	62
Σχέδιο	64
Βαθμονόμηση οθόνης αφής	66
Καθαρισμός οθόνης αφής	68
Αρχειοποίηση τηλεχειριστηρίου	70
Πληροφορίες τηλεχειριστηρίου	72
Αντιμετώπιση προβλημάτων	74
Πληροφορίες σφάλματος	74
Αυτόματη απενεργοποίηση κενού δωματίου	77
Συντήρηση	78
Πληροφορίες φίλτρου	78
Τεχνικά χαρακτηριστικά	80
Τεχνικά χαρακτηριστικά τηλεχειριστηρίου	80
Κατάλογος λειτουργιών (από 1 Οκτωβρίου 2017)	81
Λίστα λειτουργιών που μπορούν/δεν μπορούν να χρησιμοποιηθούν σε συνδυασμό ...	82

Προφυλάξεις ασφαλείας

- Διαβάστε προσεκτικά τις παρακάτω προφυλάξεις ασφαλείας, πριν χρησιμοποιήσετε τη μονάδα.
- Για τη διασφάλιση της ασφάλειας, δώστε μεγάλη προσοχή στις προφυλάξεις αυτές.

 ΠΡΟΕΙΔΟΠΟΙΗΣΗ	Υποδεικνύει κίνδυνο θανάτου ή σοβαρού τραυματισμού.
 ΠΡΟΣΟΧΗ	Υποδεικνύει κίνδυνο σοβαρού τραυματισμού ή κατασκευαστικής βλάβης.

- Αφού διαβάσετε το παρόν εγχειρίδιο, παραδώστε το στον τελικό χρήστη για να το κρατήσει για τυχόν μελλοντική παραπομπή.
- Φυλάξτε το παρόν εγχειρίδιο για μελλοντική παραπομπή και ανατρέξτε σε αυτό όποτε χρειαστεί. Το εγχειρίδιο αυτό θα πρέπει να είναι διαθέσιμο στα άτομα που επισκευάζουν ή εγκαθιστούν σε άλλη θέση το τηλεχειριστήριο. Φροντίστε να παραδοθεί το εγχειρίδιο στον εκάστοτε μελλοντικό χρήστη.

Γενικές προφυλάξεις

ΠΡΟΕΙΔΟΠΟΙΗΣΗ

Μην εγκαταστήσετε τη μονάδα σε χώρο όπου υπάρχουν μεγάλες ποσότητες λαδιού, ατμού, οργανικών διαλυτών ή διαβρωτικών αερίων όπως οξείδια του θείου, ή σε χώρο όπου χρησιμοποιούνται συχνά όξινα/αλκαλικά διαλύματα ή σπρέι. Αυτές οι ουσίες μπορεί να επηρεάσουν αρνητικά την απόδοση της μονάδας, γεγονός το οποίο μπορεί να οδηγήσει σε ηλεκτροπληξία, δυσλειτουργίες, καπνό ή φωτιά.

Για τον περιορισμό του κινδύνου εκδήλωσης βραχυκυκλώματος, διαρροής ρεύματος, ηλεκτροπληξίας, δυσλειτουργιών, καπνού ή φωτιάς, μην πλένετε το τηλεχειριστήριο με νερό ή άλλα υγρά.

Για τον περιορισμό του κινδύνου εκδήλωσης ηλεκτροπληξίας, δυσλειτουργιών, καπνού ή φωτιάς, μην χειρίζεστε τους διακόπτες/τα κουμπιά ή αγγίζετε άλλα ηλεκτρικά εξαρτήματα με βρεγμένα χέρια.

Κατά την απολύμανση της μονάδας με οινόπνευμα, εξαερίστε καλά όλα τα υγρά. Οι αναθυμιάσεις του οινοπνεύματος γύρω από τη μονάδα μπορεί να προκαλέσουν φωτιά ή έκρηξη όταν θα ενεργοποιηθεί η μονάδα.

Για τον περιορισμό του κινδύνου εκδήλωσης τραυματισμού ή ηλεκτροπληξίας, πριν ψεκάσετε με χημικό στο χώρο γύρω από το τηλεχειριστήριο, διακόψτε τη λειτουργία του και σκεπάστε το τηλεχειριστήριο.

Για τον περιορισμό του κινδύνου εκδήλωσης τραυματισμού ή ηλεκτροπληξίας, διακόψτε τη λειτουργία του τηλεχειριστηρίου και αποσυνδέστε το από την ηλεκτρική τροφοδοσία πριν από τον καθαρισμό, τη συντήρηση ή την επιθεώρηση του τηλεχειριστηρίου.

Εάν παρατηρήσετε οτιδήποτε μη φυσιολογικό (π.χ., οσμή καμένου), διακόψτε τη λειτουργία της μονάδας, απενεργοποιήστε την από το διακόπτη ισχύος και απευθυνθείτε στον αντιπρόσωπο. Αν συνεχίσει να λειτουργεί το προϊόν, μπορεί να προκληθεί ηλεκτροπληξία, δυσλειτουργία ή φωτιά.

Τοποθετήστε σωστά όλα τα απαιτούμενα καλύμματα, για να προστατέψετε το τηλεχειριστήριο από σκόνη και υγρασία. Η συγκέντρωση σκόνης και το νερό μπορεί να προκαλέσουν ηλεκτροπληξία, καπνό ή φωτιά.

ΠΡΟΣΟΧΗ

Για τον περιορισμό του κινδύνου εκδήλωσης φωτιάς ή έκρηξης, μην τοποθετείτε εύφλεκτα υλικά και μην χρησιμοποιείτε εύφλεκτα σπρέι στο χώρο γύρω από το τηλεχειριστήριο.

Για τον περιορισμό του κινδύνου πρόκλησης βλάβης στο τηλεχειριστήριο, μην ψεκάζετε με εντομοκτόνα σπρέι ή άλλα εύφλεκτα σπρέι απευθείας στο τηλεχειριστήριο.

Για να περιοριστεί ο κίνδυνος ρύπανσης του περιβάλλοντος, απευθυνθείτε σε εξουσιοδοτημένη αντιπροσωπεία για τη σωστή απόρριψη του τηλεχειριστηρίου.

Για τον περιορισμό του κινδύνου εκδήλωσης ηλεκτροπληξίας ή δυσλειτουργιών, μην χειρίζεστε τον πίνακα αφής, τους διακόπτες ή τα κουμπιά με μυτερά ή αιχμηρά αντικείμενα.

Για τον περιορισμό του κινδύνου εκδήλωσης τραυματισμού και ηλεκτροπληξίας, αποφύγετε την επαφή με τα αιχμηρά άκρα ορισμένων μερών της μονάδας.

Για την αποφυγή τραυματισμού από σπασμένα γυαλιά, μην ασκείτε υπερβολική δύναμη στα γυαλίνα μέρη.

Για τον περιορισμό του κινδύνου εκδήλωσης τραυματισμού, να φέρετε προστατευτικό εξοπλισμό όταν εργάζεστε στο χειριστήριο.

Προφυλάξεις κατά τη μετακίνηση ή την επισκευή του τηλεχειριστηρίου

ΠΡΟΕΙΔΟΠΟΙΗΣΗ

Η επισκευή και η μετακίνηση του τηλεχειριστηρίου θα πρέπει να εκτελείται μόνο από εξειδικευμένο προσωπικό. Μην αποσυναρμολογείτε και μην εκτελέσετε τροποποιήσεις στο τηλεχειριστήριο. Εάν εκτελεστεί εγκατάσταση ή επισκευή με μη ενδεδειγμένο τρόπο, μπορεί να προκληθεί τραυματισμός, ηλεκτροπληξία ή φωτιά.

ΠΡΟΣΟΧΗ

Για να περιοριστεί ο κίνδυνος βραχυκυκλώματος, ηλεκτροπληξίας, φωτιάς ή δυσλειτουργίας, μην αγγίζετε την πλακέτα κυκλωμάτων με εργαλεία ή με τα χέρια σας και μην αφήνετε να συγκεντρώνεται σκόνη στην πλακέτα κυκλωμάτων.

Πρόσθετες προφυλάξεις

Για την αποφυγή πρόκλησης βλάβης στο τηλεχειριστήριο, να χρησιμοποιείτε τα κατάλληλα εργαλεία για την εγκατάσταση, την επιθεώρηση ή την επισκευή του τηλεχειριστηρίου.

Αυτό το τηλεχειριστήριο είναι σχεδιασμένο για χρήση αποκλειστικά και μόνο με το Σύστημα διαχείρισης κτηρίων της Mitsubishi Electric. Η χρήση αυτού του τηλεχειριστηρίου με άλλα συστήματα ή για άλλους σκοπούς μπορεί να προκαλέσει δυσλειτουργίες.

Αυτή η συσκευή δεν προορίζεται για χρήση από άτομα (συμπεριλαμβανομένων των παιδιών) με περιορισμένες φυσικές, αισθητηριακές ή διανοητικές ικανότητες, ή με απουσία εμπειρίας και γνώσης, με εξαίρεση την επίβλεψη ή καθοδήγησή τους στη χρήση της συσκευής από το άτομο που είναι υπεύθυνο για την ασφάλειά τους. Απαιτείται η επίβλεψη των παιδιών, ώστε να διασφαλίζεται ότι δεν παίζουν με τη συσκευή.

Για την αποφυγή αποχρωματισμού, μην χρησιμοποιείτε βενζόλιο, αραιωτικά ή πανιά εμποτισμένα με χημικά για τον καθαρισμό του τηλεχειριστηρίου. Για να καθαρίσετε το τηλεχειριστήριο, περάστε το πρώτα με ένα μαλακό πανί που έχετε διαβρέξει σε διάλυμα ήπιου απορρυπαντικού σε νερό και, στη συνέχεια, σκουπίστε το απορρυπαντικό με ένα βρεγμένο πανί και, κατόπιν, σκουπίστε το νερό με ένα στεγνό πανί.

Για την αποφυγή πρόκλησης βλάβης στο τηλεχειριστήριο, λάβετε τα μέτρα σας για την προστασία του από το στατικό ηλεκτρισμό.

Η συσκευή αυτή προορίζεται για χρήση από έμπειρους ή εκπαιδευμένους χρήστες σε καταστήματα, στην ελαφρά βιομηχανία και σε αρκοτήματα ή για εμπορική χρήση από μη ειδικούς.

Εάν το καλώδιο ισχύος υποστεί φθορά, πρέπει να αντικατασταθεί από τον κατασκευαστή, τον αντιπρόσωπο του σέρβις ή αντίστοιχο εξειδικευμένο τεχνικό για να αποφευχθεί τυχόν κίνδυνος.

Εξαρτήματα του τηλεχειριστηρίου

Διασύνδεση τηλεχειριστηρίου - Οθόνη κατάστασης/Κύρια οθόνη

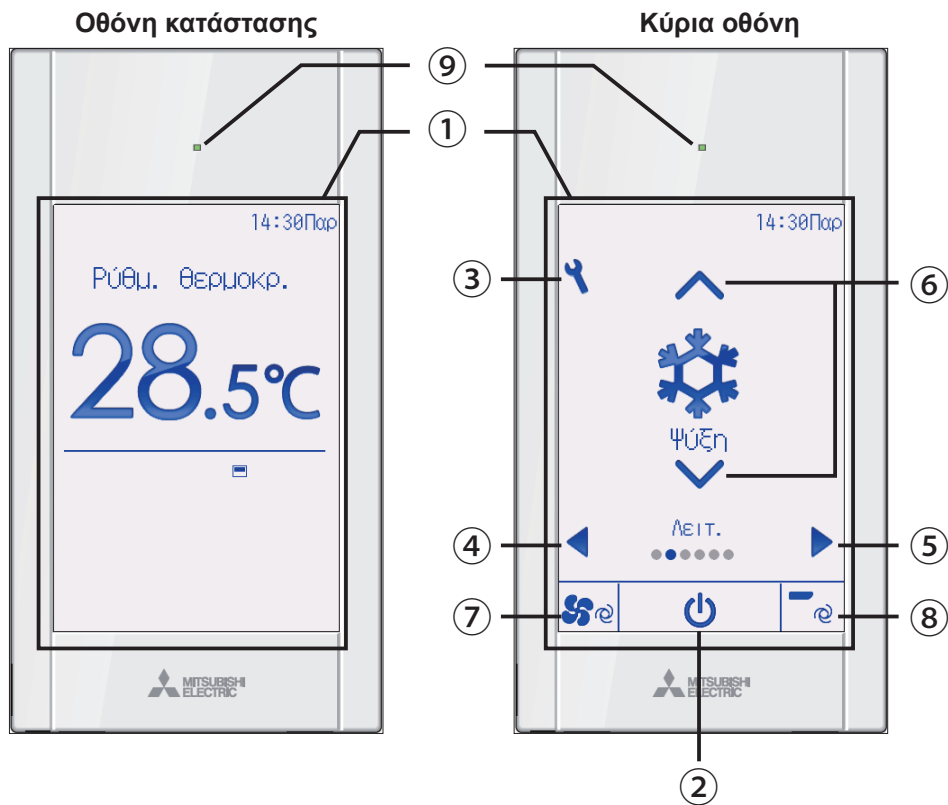

① Πίνακας αφής & Έγχρωμο LCD με οπίσθιο φωτισμό

Εμφανίζει τις ρυθμίσεις λειτουργίας. Όταν είναι κλειστός ο οπίσθιος φωτισμός και πιέσετε οποιαδήποτε περιοχή της οθόνης, θα εμφανιστεί η οθόνη κατάστασης. Ενώσω εμφανίζεται η οθόνη Κατάστασης, πιέζοντας οποιαδήποτε περιοχή αλλάζετε την οθόνη με την Κύρια οθόνη.

② Κουμπί **ON/OFF**

Πιέστε για να ΕΝΕΡΓΟΠΟΙΗΣΕΤΕ/ ΑΠΕΝΕΡΓΟΠΟΙΗΣΕΤΕ την εσωτερική μονάδα.

③ Κουμπί **ρύθμισης**

Πιέστε για να εμφανιστεί το Κύριο μενού. Αν η λειτουργία των μενού είναι κλειδωμένη, απαιτείται κωδικός διαχειριστή.

④ Κουμπί

Πιέστε για να διατρέξετε τις ρυθμίσεις με την ακόλουθη σειρά: γρίλια, εξαερισμός, περσίδα, ταχύτητα ανεμιστήρα, κατάσταση λειτουργίας και προ-ρυθμισμένη θερμοκρασία.

⑤ Κουμπί

Πιέστε για να διατρέξετε τις ρυθμίσεις με την ακόλουθη σειρά: προ-ρυθμισμένη θερμοκρασία, κατάσταση λειτουργίας, ταχύτητα ανεμιστήρα, περσίδα, εξαερισμός και γρίλια.

⑥ Κουμπί

Πιέστε για να αλλάξετε το περιεχόμενο της ρύθμισης που επιλέξατε με τα κουμπιά ④ και ⑤ παραπάνω.

⑦ Κουμπί συντόμευσης για ταχύτητα ανεμιστήρα

Πιέστε για να περάσετε απευθείας στην οθόνη ρυθμίσεων ταχύτητας του ανεμιστήρα.

⑧ Κουμπί συντόμευσης για περσίδα

Πιέστε για να περάσετε απευθείας στην οθόνη ρυθμίσεων της περσίδας.

⑨ Λυχνία ON/OFF

Αυτή η λυχνία ανάβει πράσινη όταν λειτουργεί η μονάδα, εκτός αν η ρύθμιση “Φωτισμός LED” είναι “Όχι”. Αναβοσβήνει κατά την εκκίνηση του τηλεχειριστηρίου και όταν υπάρχει σφάλμα.

Όταν είναι κλειδωμένη η λειτουργία ON/OFF, το κουμπί ② δεν εμφανίζεται.

Κατά την επιλογή επιμέρους ρυθμίσεων με τα κουμπιά ④ ή ⑤, αν η λειτουργία του επιλεγμένου στοιχείου ρύθμισης είναι κλειδωμένη, το στοιχείο ρύθμισης δεν θα εμφανίζεται.

Αν η ρύθμιση ταχύτητας του ανεμιστήρα ή η ρύθμιση της περσίδας είναι κλειδωμένες, τα κουμπιά ⑦ ή ⑧ δεν θα εμφανίζονται.

Όταν το σύστημα ελέγχεται κεντρικά, δεν μπορείτε να αλλάξετε το περιεχόμενο των ρυθμίσεων με το κουμπί ⑥.

Εξαρτήματα του τηλεχειριστηρίου

Διασύνδεση τηλεχειριστηρίου - Οθόνη μενού



① Κουμπί **ON/OFF**

Πιέστε για να ΕΝΕΡΓΟΠΟΙΗΣΕΤΕ/
ΑΠΕΝΕΡΓΟΠΟΙΗΣΕΤΕ την εσωτερική
μονάδα.

② Κουμπί **ΕΠΙΛΟΓΗΣ**

Πιέστε για να αποθηκεύσετε τη ρύθμιση.

③ Κουμπί **ΕΠΙΣΤΡΟΦΗΣ**

Πιέστε για να επιστρέψετε στην
προηγούμενη οθόνη.
Όταν εμφανίζεται το Κύριο μενού, αν
πατήσετε αυτό το κουμπί, θα εμφανιστεί η
Οθόνη κατάστασης.

④ Κουμπί **MENΟΥ** Σελίδα 24

Πιέστε για να εμφανιστεί το Κύριο μενού.

⑤ Κουμπί λειτουργίας **F1**

Οθόνη μενού: Η λειτουργία του κουμπιού
διαφέρει ανάλογα με την
οθόνη.

⑥ Κουμπί λειτουργίας **F2**

Κύριο μενού: Πιέστε για να μετακινήσετε
τον κέρσορα αριστερά.
Οθόνη μενού: Η λειτουργία του κουμπιού
διαφέρει ανάλογα με την
οθόνη.

⑦ Κουμπί λειτουργίας **F3**

Κύριο μενού: Πιέστε για να μετακινήσετε
τον κέρσορα δεξιά.
Οθόνη μενού: Η λειτουργία του κουμπιού
διαφέρει ανάλογα με την
οθόνη.

⑧ Κουμπί λειτουργίας **F4**

Οθόνη μενού: Η λειτουργία του κουμπιού
διαφέρει ανάλογα με την
οθόνη.

Οι λειτουργίες των κουμπιών
λειτουργίας αλλάζουν ανάλογα με την
οθόνη. Ανατρέξτε στον οδηγό
λειτουργίας των κουμπιών που
εμφανίζεται στο κάτω μέρος της
οθόνης LCD για τις λειτουργίες που
επιτελούν τα κουμπιά στην εκάστοτε
οθόνη.

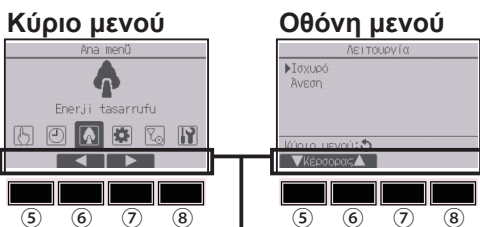

Οδηγός λειτουργίας

Εξαρτήματα του τηλεχειριστηρίου

Οθόνη - Οθόνη κατάστασης/Κύρια οθόνη

Υπάρχουν δύο διαφορετικοί τρόποι προβολής για την Οθόνη κατάστασης και την Κύρια οθόνη: “Πλήρης” και “Βασική.”
Η εργοστασιακή ρύθμιση είναι η “Πλήρης” προβολή. Για τον τρόπο εναλλαγής του τρόπου προβολής, ανατρέξτε στη σελίδα 58.

Πλήρης προβολή

* Εμφανίζονται όλα τα εικονίδια για επεξήγηση.

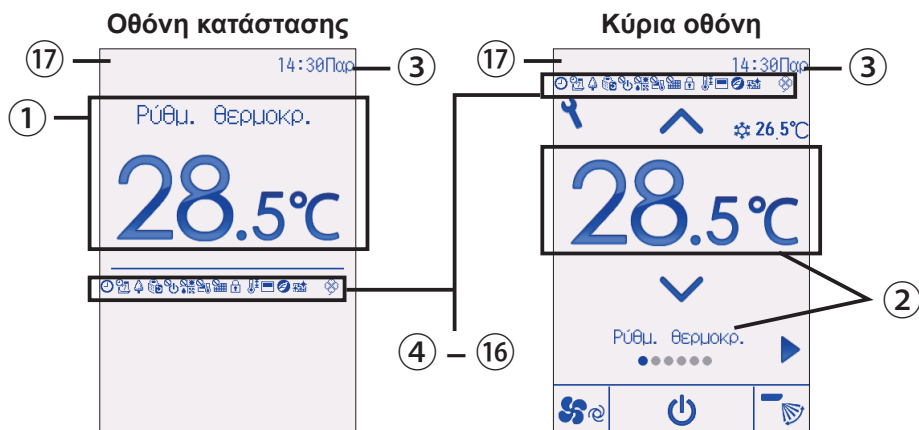

Βασική προβολή

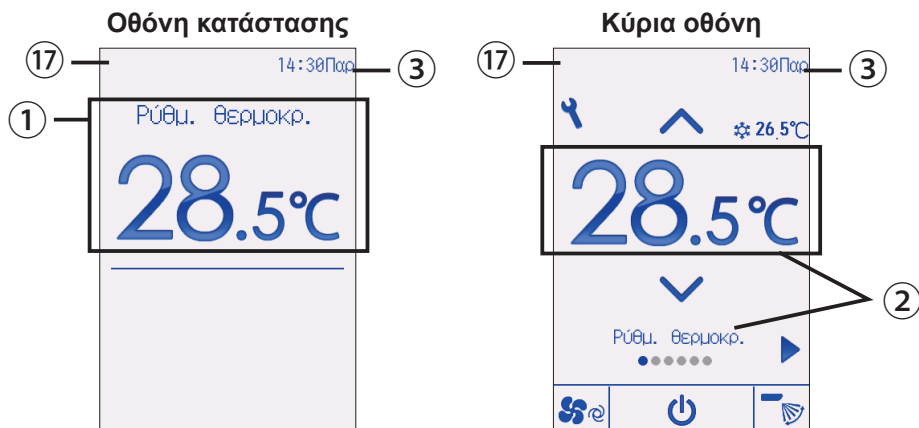

① Προ-ρυθμισμένη θερμοκρασία ή θερμοκρασία δωματίου

Εδώ εμφανίζεται η προ-ρυθμισμένη θερμοκρασία ή η θερμοκρασία του δωματίου. (Βλ. Εγχειρίδιο εγκατάστασης.)

② Στοιχείο ρύθμισης και περιεχόμενο ρύθμισης Σελίδα 17

Εδώ εμφανίζονται τα στοιχεία ρύθμισης “Προ-ρυθμισμένη θερμοκρασία” ↔ “Κατάσταση λειτουργίας” ↔ “Ταχύτητα ανεμιστήρα” ↔ “Περίοδος” ↔ “Εξαερισμός” ↔ “Γρίλια” και το περιεχόμενο αυτών των ρυθμίσεων. Η ένδειξη “Κεντρικός έλεγχος” εμφανίζεται για ορισμένο διάστημα αν έχει επιλεγθεί κάποια κεντρικά ελεγχόμενη ρύθμιση.

③ Ρολόι

Εδώ εμφανίζεται η τρέχουσα ώρα. (Βλ. Εγχειρίδιο εγκατάστασης.)

④ Σελίδα 29, 32, 40

Εμφανίζεται όταν έχουν ενεργοποιηθεί οι εξής λειτουργίες: “Χρονοδιακόπτης On/Off” (σελ. 29), “Νυχτερινή λειτουργία” (σελ. 40) ή “Χρονοδιακόπτης Αυτόματου Off” (σελ. 32).

 εμφανίζεται όταν έχει απενεργοποιηθεί ο χρονοδιακόπτης από το κεντρικό σύστημα ελέγχου.

⑤ Σελίδα 34

Εμφανίζεται όταν έχει ενεργοποιηθεί ο εβδομαδιαίος χρονοδιακόπτης.

⑥ Σελίδα 51

Εμφανίζεται όταν οι μονάδες λειτουργούν σε κατάσταση εξοικονόμησης ενέργειας. (Δεν εμφανίζεται σε ορισμένα μοντέλα εσωτερικών μονάδων)

⑦ Σελίδα 37

Εμφανίζεται όταν οι εξωτερικές μονάδες λειτουργούν στο αθόρυβο.

⑧

Εμφανίζεται όταν η λειτουργία ON/OFF ελέγχεται κεντρικά.

⑨

Εμφανίζεται όταν η κατάσταση λειτουργίας ελέγχεται κεντρικά.

⑩

Εμφανίζεται όταν η προ-ρυθμισμένη θερμοκρασία ελέγχεται κεντρικά.

⑪

Εμφανίζεται όταν η λειτουργία επαναφοράς φίλτρου ελέγχεται κεντρικά.

⑫ Σελίδα 46

Εμφανίζεται όταν τα κουμπιά είναι κλειδωμένα.

⑬ Σελίδα 43

Εμφανίζεται όταν το εύρος προ-ρυθμισμένης θερμοκρασίας είναι περιορισμένο.

⑭

Εμφανίζεται όταν έχει ενεργοποιηθεί το ενσωματωμένο θερμίστορ στο τηλεχειριστήριο για την παρακολούθηση της θερμοκρασίας δωματίου.

εμφανίζεται όταν έχει ενεργοποιηθεί το θερμίστορ στην εσωτερική μονάδα για την παρακολούθηση της θερμοκρασίας δωματίου.

⑮

Εμφανίζεται όταν πραγματοποιείται λειτουργία εξοικονόμησης ενέργειας με χρήση “3D i-See sensor”.

⑯ Σελίδα 78

Δείχνει πότε χρειάζεται συντήρηση το φίλτρο.

⑰ Ένδειξη προκαταρκτικού σφάλματος

Αν προκύψει προκαταρκτικό σφάλμα, εμφανίζεται κωδικός σφάλματος.

Διάρθρωση των μενού και εικονίδια

Διάρθρωση των μενού

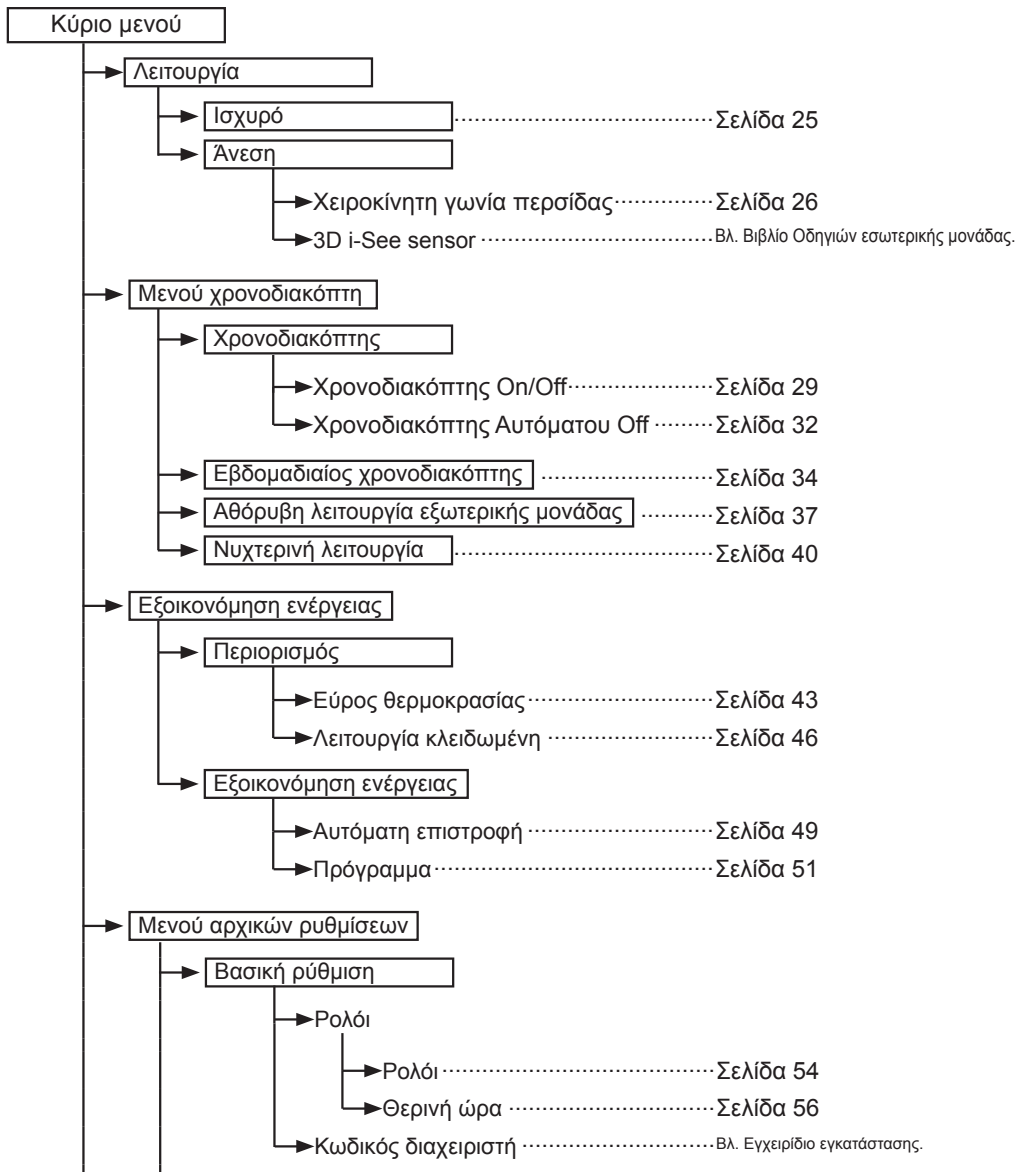

→	Ρύθμιση οθόνης	
	→ Κύρια οθόνη.....	Σελίδα 58
	→ Λεπτομέρειες οθόνης (Επεξήγηση εικονιδίων κ.λπ.).....	Βλ. Εγχειρίδιο εγκατάστασης.
	→ Φωτεινότητα.....	Σελίδα 61
	→ Επιλογή γλώσσας.....	Σελίδα 62
	→ Σχέδιο.....	Σελίδα 64
→	Ρύθμιση λειτουργίας	
	→ Αυτόματη λειτουργία.....	Βλ. Εγχειρίδιο εγκατάστασης.
→	Οθόνη αφής	Σελίδα 66
→	Μενού συντήρησης	
	→ Πληροφορίες σφάλματος.....	Σελίδα 74
	→ Πληροφορίες φίλτρου.....	Σελίδα 78
	→ Καθαρισμός	
	→ Κάλυμμα αυτόματης καθόδου.....	Ανατρέξτε στο Εγχειρίδιο Οδηγιών που συνοδεύει το κάλυμμα αυτόματης ανύψωσης.
	→ Λειτουργία καθόδου.....	Ανατρέξτε στο Εγχειρίδιο Οδηγιών που συνοδεύει το κάλυμμα αυτόματης ανύψωσης.
	→ Ρύθμιση καθόδου.....	Ανατρέξτε στο Εγχειρίδιο Οδηγιών που συνοδεύει το κάλυμμα αυτόματης ανύψωσης.
→	Μενού service	
	→ Μενού δοκιμής λειτουργίας	
	→ Δοκιμή λειτουργίας.....	Βλ. Εγχειρίδιο εγκατάστασης εσωτερικής μονάδας.
	→ Δοκιμή λειτουργίας αντλίας αποστράγγισης.....	Βλ. Εγχειρίδιο εγκατάστασης εσωτερικής μονάδας.
	→ Στοιχεία συντήρησης.....	Βλ. Εγχειρίδιο εγκατάστασης εσωτερικής μονάδας.
	→ Εισαγωγή ονόματος μοντέλου.....	Βλ. Εγχειρίδιο εγκατάστασης εσωτερικής μονάδας.
	→ Εισαγωγή αριθμού σειράς.....	Βλ. Εγχειρίδιο εγκατάστασης εσωτερικής μονάδας.
	→ Εισαγωγή στοιχείων αντιπροσώπου.....	Βλ. Εγχειρίδιο εγκατάστασης εσωτερικής μονάδας.
	→ Αρχικοποίηση στοιχείων συντήρησης.....	Βλ. Εγχειρίδιο εγκατάστασης εσωτερικής μονάδας.

Διάρθρωση των μενού και εικονίδια

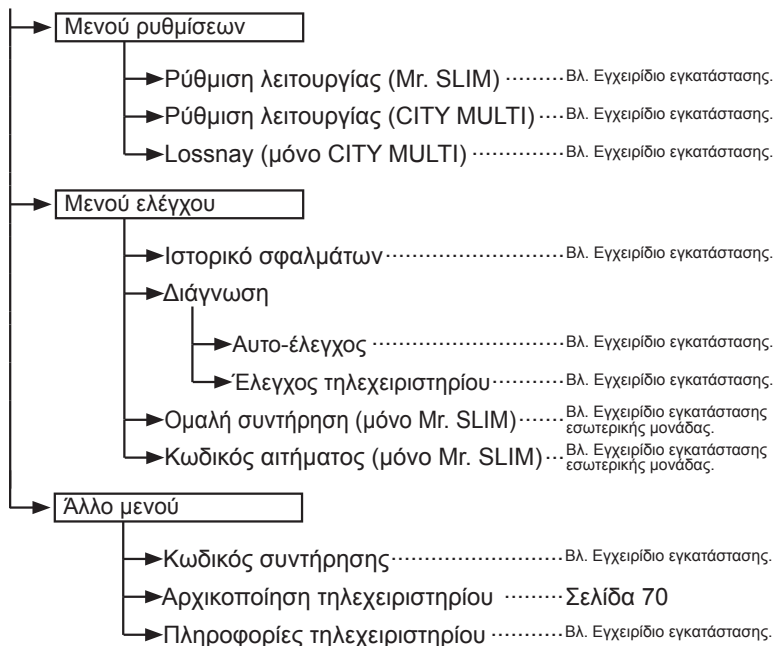

Δεν είναι διαθέσιμες όλες οι λειτουργίες σε όλα τα μοντέλα εσωτερικών μονάδων.

Λειτουργία τηλεχειριστηρίου

Χρονοδιακόπτης



Στον ακόλουθο πίνακα συνοψίζονται τα τετράγωνα εικονίδια που χρησιμοποιούνται σε αυτό το εγχειρίδιο.



Για να αλλάξετε τις ρυθμίσεις, θα πρέπει να καταχωρίσετε τον κωδικό διαχειριστή ή τον κωδικό συντήρησης στην οθόνη εισαγωγής κωδικού πρόσβασης. Αυτή η διαδικασία δεν μπορεί να παραληφθεί για καμία ρύθμιση.

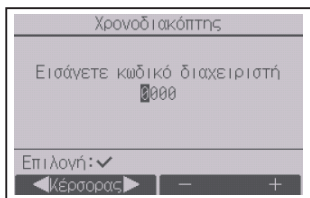

F1 F2 F3 F4

- F1** : Πιέστε για να μετακινήσετε τον κέρσορα αριστερά.
- F2** : Πιέστε για να μετακινήσετε τον κέρσορα δεξιά.
- F3** : Πιέστε για να μειώσετε την τιμή κατά 1.
- F4** : Πιέστε για να αυξήσετε την τιμή κατά 1.

* Δεν μπορούν να γίνουν αλλαγές αν δεν εισαχθεί ο σωστός κωδικός.



Δείχνει ρυθμίσεις που μπορούν να αλλάξουν μόνο όταν λειτουργούν οι μονάδες.



Δείχνει ρυθμίσεις που μπορούν να αλλάξουν μόνο όταν δεν λειτουργούν οι μονάδες.



Δείχνει ρυθμίσεις που μπορούν να αλλάξουν μόνο όταν οι μονάδες λειτουργούν στην Ψύξη, στη Θέρμανση ή στο Αυτόματο.



Δείχνει λειτουργίες που δεν είναι διαθέσιμες όταν τα κουμπιά είναι κλειδωμένα ή όταν το σύστημα ελέγχεται κεντρικά.

Βασικές λειτουργίες

Ενεργοποίηση/Απενεργοποίηση (ON/OFF)



Λειτουργία κουμπιών

ON



Πιέστε το κουμπί **ON/OFF**.

Η λυχνία ON/OFF θα ανάψει πράσινη και θα ξεκινήσει η λειτουργία.

Αν η ρύθμιση “Φωτισμός LED” είναι “Όχι” η λυχνία ON/OFF δεν ανάβει.

Κουμπί **ON/OFF**

OFF



Πιέστε ξανά το κουμπί **ON/OFF**.

Η λυχνία ON/OFF θα σβήσει και η λειτουργία θα σταματήσει.

Ρυθμίσεις κατάστασης λειτουργίας, θερμοκρασίας, ταχύτητας ανεμιστήρα, περσίδας, γρίλιας και εξαερισμού (Lossnay)



Λειτουργία κουμπιών

Κατάσταση λειτουργίας



Κάθε φορά που πατάτε το κουμπί ▼ ή ▲ περνάτε διαδοχικά από τις ακόλουθες καταστάσεις λειτουργίας. Επιλέξτε την επιθυμητή κατάσταση λειτουργίας.



Ψύξη



Αφύγρανση



Ανεμιστήρας



Αυτόματο



Θέρμανση

- Οι καταστάσεις λειτουργίας που δεν είναι διαθέσιμες στα συνδεδεμένα μοντέλα εσωτερικών μονάδων δεν θα εμφανίζονται στην οθόνη.

Τι σημαίνει όταν αναβοσβήνει το εικονίδιο κατάστασης λειτουργίας

Το εικονίδιο κατάστασης λειτουργίας αναβοσβήνει όταν υπάρχουν άλλες εσωτερικές μονάδες στο ίδιο σύστημα ψύξης (συνδεδεμένες στην ίδια εξωτερική μονάδα) που λειτουργούν ήδη σε διαφορετική κατάσταση λειτουργίας. Σε αυτή την περίπτωση, οι υπόλοιπες μονάδες που ανήκουν στην ίδια ομάδα μπορούν να λειτουργήσουν μόνο στην ίδια κατάσταση λειτουργίας.

<Αυτόματη λειτουργία (δύο θέσεων ρύθμισης)>

Στην Αυτόματη λειτουργία (δύο θέσεων ρύθμισης), μπορείτε να ορίσετε δύο προ-ρυθμισμένες θερμοκρασίες (μία για ψύξη και μία για θέρμανση). Ανάλογα με τη θερμοκρασία του δωματίου, η εσωτερική μονάδα θα λειτουργεί αυτόματα σε Ψύξη ή Θέρμανση και θα διατηρεί τη θερμοκρασία του δωματίου μέσα στο προ-ρυθμισμένο εύρος. Το παρακάτω γράφημα δείχνει το μοτίβο λειτουργίας της εσωτερικής μονάδας στην Αυτόματη λειτουργία (δύο θέσεων ρύθμισης).

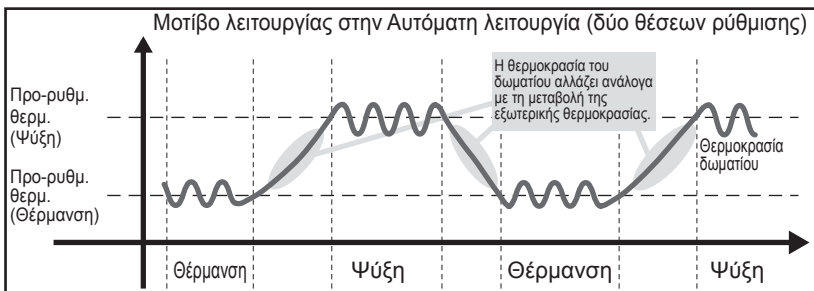



Βασικές λειτουργίες

Προ-ρυθμισμένη θερμοκρασία

<Ψύξη, Αφύγρανση, Θέρμανση και Αυτόματο (μία θέση ρύθμισης)>





Πιέστε το κουμπί  για να μειώσετε την προ-ρυθμισμένη θερμοκρασία και το κουμπί  για να την αυξήσετε.

- Ανατρέξτε στον πίνακα στη σελίδα 19 για το επιτρεπόμενο εύρος ρύθμισης της θερμοκρασίας στις διάφορες καταστάσεις λειτουργίας.
- Δεν μπορεί να οριστεί προ-ρυθμισμένο εύρος θερμοκρασίας στη λειτουργία Ανεμιστήρα/Εξαερισμού.
- Η προ-ρυθμισμένη θερμοκρασία θα εμφανίζεται είτε σε βαθμούς Κελσίου ανά βήματα 0,5 ή 1 βαθμού, είτε σε βαθμούς Φαρενάιτ, ανάλογα με το μοντέλο εσωτερικής μονάδας και τη ρύθμιση προβολής της οθόνης στο τηλεχειριστήριο.

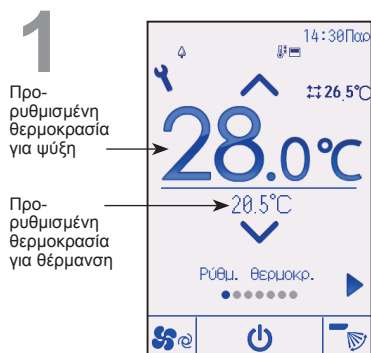
<Αυτόματη λειτουργία (δύο θέσεων ρύθμισης)>



Θα εμφανιστούν οι τρέχουσες προ-ρυθμισμένες θερμοκρασίες.



Κάθε φορά που πατάτε το κουμπί  ή , θα εναλλάσσονται οι προ-ρυθμισμένες θερμοκρασίες για τη λειτουργία ψύξης και θέρμανσης.

2

Προ-ρυθμισμένη θερμοκρασία για ψύξη

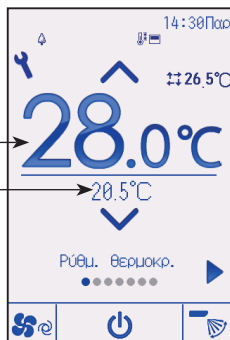
Προ-ρυθμισμένη θερμοκρασία για θέρμανση



Πιέστε το κουμπί  για να μειώσετε την επιλεγμένη θερμοκρασία και το κουμπί  για να την αυξήσετε.

- Ανατρέξτε στον παρακάτω πίνακα για το επιτρεπόμενο εύρος ρύθμισης της θερμοκρασίας στις διάφορες καταστάσεις λειτουργίας.
- Οι προ-ρυθμισμένες τιμές θερμοκρασίας για ψύξη και θέρμανση στην Αυτόματη λειτουργία (δύο θέσεων ρύθμισης) χρησιμοποιούνται και στις λειτουργίες Ψύξης/Αφύγρανσης και Θέρμανσης.
- Οι προ-ρυθμισμένες τιμές θερμοκρασίας για ψύξη και θέρμανση στην Αυτόματη λειτουργία (δύο θέσεων ρύθμισης) θα πρέπει να ικανοποιούν τις ακόλουθες προϋποθέσεις:
 - Η προ-ρυθμισμένη θερμοκρασία ψύξης θα πρέπει να είναι υψηλότερη από την προ-ρυθμισμένη θερμοκρασία θέρμανσης.
 - Θα πρέπει να ικανοποιείται η ελάχιστη απαιτούμενη διαφορά θερμοκρασίας μεταξύ προ-ρυθμισμένης θερμοκρασίας ψύξης και προ-ρυθμισμένης θερμοκρασίας θέρμανσης (διαφέρει ανάλογα με τα συνδεδεμένα μοντέλα εσωτερικών μονάδων).
 - Αν οι προ-ρυθμισμένες θερμοκρασίες δεν ικανοποιούν την ελάχιστη απαιτούμενη διαφορά θερμοκρασίας, και οι δύο προ-ρυθμισμένες θερμοκρασίες θα αλλάξουν αυτόματα μέσα στα επιτρεπόμενα εύρη ρύθμισης.

Επιτρεπόμενο εύρος προ-ρυθμισμένης θερμοκρασίας



Κατάσταση λειτουργίας	Εύρος προ-ρυθμισμένης θερμοκρασίας
Ψύξη/Αφύγρανση	19 ~ 30°C (67 ~ 87°F)
Θέρμανση	17 ~ 28°C (63 ~ 83°F)
Αυτόματο (Μία θέση ρύθμισης)	19 ~ 28°C (67 ~ 83°F)
Αυτόματο (Δύο θέσεις ρύθμισης)	[Ψύξη] Εύρος προ-ρυθμισμένης θερμοκρασίας για λειτουργία Ψύξης [Θέρμανση] Εύρος προ-ρυθμισμένης θερμοκρασίας για λειτουργία Θέρμανσης
Ανεμιστήρας/Εξαερισμός	Δεν ρυθμίζεται

Το επιτρεπόμενο εύρος ρύθμισης της θερμοκρασίας διαφέρει ανάλογα με το μοντέλο των εσωτερικών μονάδων.

Βασικές λειτουργίες

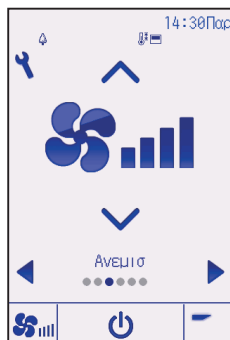
Ταχύτητα ανεμιστήρα



Κάθε φορά που πατάτε το κουμπί  ή  περνάτε διαδοχικά από τις ακόλουθες ταχύτητες του ανεμιστήρα.





- Οι διαθέσιμες ταχύτητες του ανεμιστήρα εξαρτώνται από τα μοντέλα των συνδεδεμένων εσωτερικών μονάδων.

Ρύθμιση περσίδας



(Ενδεικτική οθόνη στο CITY MULTI)

Κάθε φορά που πατάτε το κουμπί  ή  περνάτε διαδοχικά από τις ακόλουθες ρυθμίσεις της περσίδας. Επιλέξτε την επιθυμητή ρύθμιση.

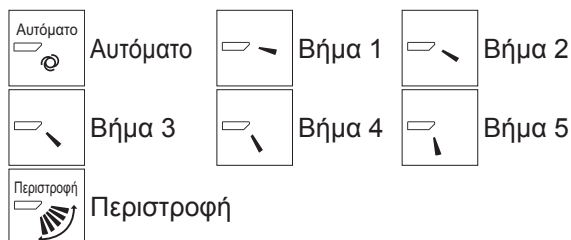

Επιλέξτε “Περιστροφή” για να μετακινούνται αυτόματα πάνω κάτω οι περσίδες.

Αν ρυθμιστεί στο “Βήμα 1” έως το “Βήμα 5”, η περσίδα θα παραμένει σταθερή στην επιλεγμένη γωνία.

-  στα αριστερά του εικονιδίου ρύθμισης της περσίδας Αυτό το εικονίδιο εμφανίζεται όταν η περσίδα έχει ρυθμιστεί στο Βήμα 2, 3, 4 ή 5 και ο ανεμιστήρας λειτουργεί με χαμηλή ταχύτητα σε ψύξη ή αφύγρανση (ανάλογα με το μοντέλο). Το εικονίδιο σβήνει μετά από μία ώρα και η ρύθμιση της περσίδας αλλάζει αυτόματα.

Ρύθμιση γρίλιας

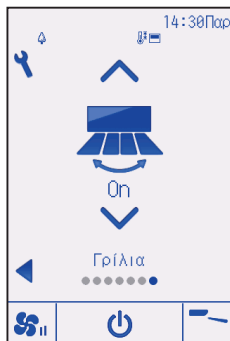

(Ενδεικτική οθόνη στο CITY MULTI)

Πιέστε το κουμπί ▼ ή ▲ για να ενεργοποιήσετε ή να απενεργοποιήσετε την περιστροφή της γρίλιας.



Απενεργοποιημένο



Ενεργοποιημένο

Ρύθμιση εξαερισμού

Ο εξαερισμός μπορεί να ρυθμιστεί και με τις μονάδες σε λειτουργία.



(Ενδεικτική οθόνη στο Mr. SLIM)

Κάθε φορά που πατάτε το κουμπί ▼ ή ▲ περνάτε διαδοχικά από τις ακόλουθες ρυθμίσεις εξαερισμού.

* Ρυθμίζεται μόνο αν έχει συνδεθεί μονάδα Lossnay.



Απενεργοποιημένο



Χαμηλό



Υψηλό

• Σε ορισμένα μοντέλα εσωτερικών μονάδων, ο ανεμιστήρας μπορεί να διασυνδεθεί με ορισμένα μοντέλα μονάδων εξαερισμού.

Πλοήγηση στα μενού

Λίστα Κύριου μενού

Κύριο μενού	Στοιχεία ρύθμισης		Λεπτομέρειες ρύθμισης	Σελίδα
Λειτουργία	Ισχυρό		Χρησιμοποιείται για να φτάσει γρήγορα το δωμάτιο σε μια άνετη θερμοκρασία. • Οι μονάδες μπορούν να λειτουργήσουν στην Ισχυρή κατάσταση λειτουργίας για έως και 30 λεπτά.	25
	Άνεση	Χειροκίνητη γωνία περσίδας	Ρυθμίζει τη γωνία κάθε περσίδας.	26
Χρονοδιακόπτης	Χρονοδιακόπτης	Χρονοδιακόπτης On/Off	Ρυθμίζει τους χρόνους ενεργοποίησης/απενεργοποίησης λειτουργίας. • Ο χρόνος ρυθμίζεται ανά βήματα των 5 λεπτών. * Πρέπει να έχει ρυθμιστεί το ρολόι.	29
		Χρονοδιακόπτης Αυτόματου Off	Ρυθμίζει το χρόνο αυτόματης απενεργοποίησης. • Ο χρόνος μπορεί να ρυθμιστεί από 30 έως 240 λεπτά ανά βήματα των 10 λεπτών.	32
	Εβδομαδιαίος χρονοδιακόπτης		Ρυθμίζει τους χρόνους ενεργοποίησης/απενεργοποίησης κατά την εβδομαδιαία λειτουργία. • Μπορούν να ρυθμιστούν έως οκτώ μοτίβα λειτουργίας για κάθε ημέρα. • Μπορούν να ρυθμιστούν δύο τύποι εβδομαδιαίου προγράμματος. * Πρέπει να έχει ρυθμιστεί το ρολόι. * Δεν ισχύει όταν έχει ενεργοποιηθεί ο χρονοδιακόπτης On/Off. * Βήματα 1°C	34
	Αθόρυβη λειτουργία εξωτερικής μονάδας		Ρυθμίζει τις χρονικές περιόδους κατά τις οποίες δίνεται προτεραιότητα στην αθόρυβη λειτουργία των εξωτερικών μονάδων έναντι του ελέγχου θερμοκρασίας. Ρυθμίστε τους χρόνους Έναρξης/Διακοπής για κάθε ημέρα της εβδομάδας. • Επιλέξτε το επιθυμητό επίπεδο αθόρυβης λειτουργίας: “Κανον.,” “Μεσαίο” και “Αθόρυβο”. * Πρέπει να έχει ρυθμιστεί το ρολόι.	37
	Νυχτερινή λειτουργία		Ρυθμίζει τη Νυχτερινή λειτουργία. • Επιλέξτε “Ναι” για να ενεργοποιήσετε τη ρύθμιση και “Όχι” για να την απενεργοποιήσετε. Μπορείτε να ρυθμίσετε το εύρος θερμοκρασίας και τους χρόνους έναρξης/διακοπής. * Πρέπει να έχει ρυθμιστεί το ρολόι. * Βήματα 1°C	40
Εξοικονόμηση ενέργειας	Περιορισμός	Εύρος θερμοκρασίας	Περιορίζει το εύρος προ-ρυθμισμένης θερμοκρασίας. • Μπορούν να οριστούν διαφορετικά εύρη θερμοκρασίας για τις διάφορες καταστάσεις λειτουργίας. * Βήματα 1°C	43
		Λειτουργία κλειδωμένη	Κλειδώνει επιλεγμένες λειτουργίες. • Δεν επιτρέπεται η πρόσβαση στις κλειδωμένες λειτουργίες.	46
	Εξοικονόμηση ενέργειας	Αυτόματη επιστροφή	Επαναφέρει τις μονάδες στην προ-ρυθμισμένη θερμοκρασία λειτουργίας αφού θα έχουν λειτουργήσει σε κατάσταση εξοικονόμησης ενέργειας για ορισμένο διάστημα. • Μπορείτε να ρυθμίσετε το χρόνο από 30 έως 120 λεπτά ανά βήματα των 10 λεπτών. * Αυτή η λειτουργία δεν είναι δυνατή αν τα εύρη προ-ρυθμισμένης θερμοκρασίας είναι περιορισμένα. * Βήματα 1°C	49

Κύριο μενού	Στοιχεία ρύθμισης		Λεπτομέρειες ρύθμισης	Σελίδα
Εξοικονόμηση ενέργειας	Εξοικονόμηση ενέργειας	Πρόγραμμα	<p>Ρυθμίζει τους χρόνους έναρξης/διακοπής λειτουργίας των μονάδων στην κατάσταση εξοικονόμησης ενέργειας για κάθε ημέρα της εβδομάδας, καθώς και το βαθμό εξοικονόμησης ενέργειας.</p> <ul style="list-style-type: none"> Μπορούν να ρυθμιστούν έως τέσσερα μοτίβα εξοικονόμησης ενέργειας για κάθε ημέρα. Ο χρόνος ρυθμίζεται ανά βήματα των 5 λεπτών. Ο βαθμός εξοικονόμησης ενέργειας μπορεί να ρυθμιστεί από 0% και 50 έως 90% ανά βήματα του 10%. <p>* Πρέπει να έχει ρυθμιστεί το ρολόι.</p>	51
Αρχική ρύθμιση	Βασική ρύθμιση	Ρολόι	Ρυθμίζει την τρέχουσα ώρα.	54
		Θερινή ώρα	Ρυθμίζει τη θερινή ώρα.	56
	Ρύθμιση οθόνης	Κύρια οθόνη	Εναλλαγή μεταξύ “Πλήρης” και “Βασική” προβολής για την Οθόνη κατάστασης και την Κύρια οθόνη. • Η προεπιλεγμένη ρύθμιση είναι “Πλήρης”.	58
		Φωτεινότητα	Ρυθμίζει τη φωτεινότητα της οθόνης.	61
		Επιλογή γλώσσας	Επιλογή της επιθυμητής γλώσσας.	62
		Σχέδιο	Αλλαγή του χρώματος της Οθόνης κατάστασης και της Κύριας οθόνης.	64
	Οθόνη αφής	Βαθμονόμηση οθόνης αφής	Ορίζει τις ρυθμίσεις βαθμονόμησης για την οθόνη αφής.	66
		Καθαρισμός οθόνης αφής	Απενεργοποιεί προσωρινά την απόκριση της οθόνης στις εντολές αφής, ώστε να μπορεί να καθαριστεί.	68
Σέρβις	Αρχικοποίηση τηλεχειριστηρίου		Επαναφέρει το τηλεχειριστήριο στις αρχικές εργοστασιακές ρυθμίσεις.	70
	Πληροφορίες τηλεχειριστηρίου		Εμφανίζει το όνομα μοντέλου, την έκδοση λογισμικού και τον αριθμό σειράς του τηλεχειριστηρίου.	72
Συντήρηση	Πληροφορίες σφάλματος		<p>Εμφανίζει πληροφορίες όταν προκύπτει ένα σφάλμα.</p> <ul style="list-style-type: none"> Μπορούν να εμφανιστούν οι εξής πληροφορίες: κωδικός σφάλματος, πηγή σφάλματος, διεύθυνση ψυκτικού, μοντέλο μονάδας, αριθμός κατασκευής, πληροφορίες επαφής (τηλέφωνο αντιπροσώπου). <p>* Το μοντέλο μονάδας, ο αριθμός κατασκευής και οι πληροφορίες επαφής θα πρέπει να έχουν καταχωριστεί προηγουμένως για να εμφανιστούν.</p>	74
	Πληροφορίες φίλτρου		<p>Για έλεγχο της κατάστασης του φίλτρου.</p> <ul style="list-style-type: none"> Μπορεί να γίνει επαναφορά του συμβόλου του φίλτρου. 	78

Πλοήγηση στα μενού

Πλοήγηση στο Κύριο μενού

Λειτουργία κουμπιών

Πρόσβαση στο Κύριο μενού



Πιέστε το κουμπί **ρύθμισης** στην Κύρια οθόνη.

Θα εμφανιστεί το Κύριο μενού.

Επιλογή στοιχείου



Πιέστε **F2** για να μετακινήσετε τον κέρσορα αριστερά.

Πιέστε **F3** για να μετακινήσετε τον κέρσορα δεξιά.

Κέρσορας

Ρυθμίσεις λειτουργίας

Ισχυρό



Περιγραφή λειτουργίας

Η ρύθμιση "Ισχυρό" επιτρέπει στις μονάδες να λειτουργήσουν πάνω από την κανονική απόδοση, έτσι ώστε να προσαρμοστεί γρήγορα ο αέρας του δωματίου στη βέλτιστη θερμοκρασία. Αυτή η λειτουργία διαρκεί έως 30 λεπτά και η μονάδα επιστρέφει στην κανονική λειτουργία μετά τα 30 λεπτά ή όταν η θερμοκρασία του δωματίου φτάσει στην προ-ρυθμισμένη θερμοκρασία, ό,τι προκύψει πρώτο. Οι μονάδες επιστρέφουν στην κανονική λειτουργία αν αλλάξει η κατάσταση λειτουργίας ή η ταχύτητα του ανεμιστήρα.

Λειτουργία κουμπιών

1



Επιλέξτε "Ισχυρό" από το μενού Λειτουργίας σε κατάσταση Ψύξης, Θέρμανσης ή Αυτόματης λειτουργίας και πιέστε το κουμπί **ΕΠΙΛΟΓΗΣ**.

Η λειτουργία "Ισχυρό" είναι διαθέσιμη μόνο στα μοντέλα που υποστηρίζουν αυτή τη λειτουργία.

2



Μετακινήστε τον κέρσορα στο "Ναι" με το κουμπί **F3** ή **F4** και πιέστε το κουμπί **ΕΠΙΛΟΓΗΣ**.

Θα εμφανιστεί μια οθόνη επιβεβαίωσης.

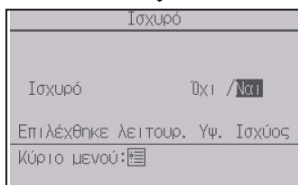

Πλοήγηση στις οθόνες

- Επιστροφή στο Κύριο μενού Κουμπί **ΜΕΝΟΥ**
- Επιστροφή στην προηγούμενη οθόνη... Κουμπί **ΕΠΙΣΤΡΟΦΗΣ**

Ρυθμίσεις λειτουργίας

Χειροκίνητη γωνία περισίδας

OFF

Λειτουργία κουμπιών

1

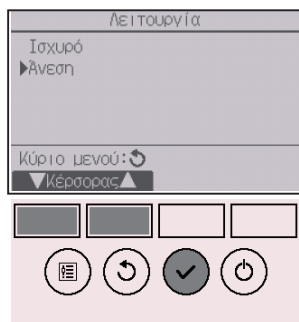

Επιλέξτε “Άνεση” στο μενού Λειτουργίας και πιάστε το κουμπί **[ΕΠΙΛΟΓΗΣ]**.

2



Επιλέξτε “Χειροκ. γωνία περισίδας” με το κουμπί **[F1]** ή **[F2]** και πιάστε το κουμπί **[ΕΠΙΛΟΓΗΣ]**.

3



Μετακινήστε τον κέρσορα στο στοιχείο “Διεύθ. ψυκτ.” ή “Αρ. Μον.” και πιέστε το κουμπί **[F1]** για επιλογή. Με το κουμπί **[F2]** ή **[F3]** επιλέξτε τη διεύθυνση ψυκτικού και τον αριθμό μονάδας για τις μονάδες των οποίων θέλετε να ρυθμίσετε τις περισίδες, και μετά πιέστε το κουμπί **[ΕΠΙΛΟΓΗΣ]**.

- Διεύθ. ψυκτ.: Διεύθυνση ψυκτικού
- Αρ. Μον.: 1, 2, 3, 4

Πιέστε το κουμπί **[F4]** για να επιβεβαιώσετε την επιλογή της μονάδας.

Αριστερά εικονίζεται μια ενδεικτική οθόνη σε μονάδα Mr. SLIM. Στις μονάδες CITY MULTI, εμφανίζεται η ένδειξη, “Διεύθ. M-NET” αντί για “Διεύθ. ψυκτ.” και η ένδειξη “Αρ. Μον.” δεν εμφανίζεται.

4

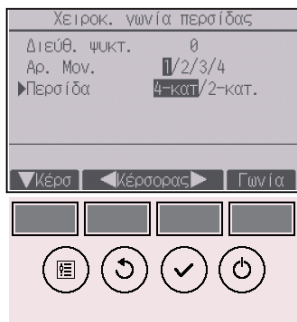

Επιλέξτε “Περισίδα” με το κουμπί **[F1]**.

Επιλέξτε “4-κατ.” ή “2-κατ.” με το κουμπί **[F2]** ή **[F3]**, και πιέστε το κουμπί **[F4]**.

Ρυθμίσεις λειτουργίας

5

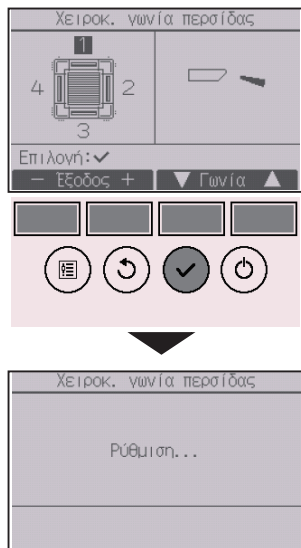

Θα εμφανιστεί η τρέχουσα ρύθμιση της περσίδας.

Επιλέξτε τις επιθυμητές εξόδους μεταξύ “1”, “2”, “3”, “4” ή “1, 2, 3, 4 (όλες οι εξοδοί)” με το κουμπί [F1] ή [F2].

Πιέστε το κουμπί [F3] ή [F4] για να διατρέξετε τις ακόλουθες επιλογές και να επιλέξετε την επιθυμητή ρύθμιση.

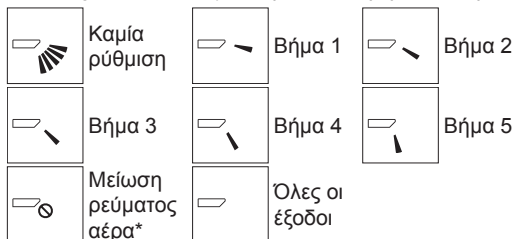

Πιέστε το κουμπί [ΕΠΙΛΟΓΗΣ] για να αποθηκευτούν οι ρυθμίσεις.

Θα εμφανιστεί μια οθόνη που δείχνει ότι αποστέλλονται οι πληροφορίες ρύθμισης στην επιλεγμένη έξοδο.

Οι αλλαγές ρύθμισης θα εφαρμοστούν στην επιλεγμένη έξοδο.

Η οθόνη θα επιστρέψει αυτόματα στην προηγούμενη οθόνη μόλις ολοκληρωθεί η αποστολή των ρυθμίσεων. Ρυθμίστε τις άλλες εξόδους με την ίδια διαδικασία.

Αν επιλεχθούν όλες οι εξοδοί, την επόμενη φορά που θα τεθεί σε λειτουργία η μονάδα θα εμφανίζεται η ένδειξη .

Πλοήγηση στις οθόνες

• Επιστροφή στην προηγούμενη οθόνη ... Κουμπί [ΕΠΙΣΤΡΟΦΗΣ]

*Μείωση ρεύματος αέρα

Η λειτουργία [Μείωσης ρεύματος αέρα] διατηρεί την περσίδα πιο οριζόντια σε σχέση με τη γωνία της περσίδας στο Βήμα 1, ώστε η ροή του αέρα να μην κατευθύνεται πάνω στους ανθρώπους.

Αυτή η λειτουργία μπορεί να ρυθμιστεί μόνο για μία έξοδο.

Αυτή η λειτουργία δεν μπορεί να ρυθμιστεί σε μοντέλα με δύο ή τρεις εξόδους.

Στη λειτουργία Μείωσης ρεύματος αέρα, η ροή του αέρα ενδέχεται να αλλοιώσει το χρώμα της οροφής.

Λειτουργία κουμπιών

1

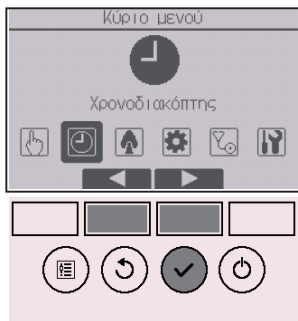

Επιλέξτε “Χρονοδιακόπτης” από το Κύριο μενού (βλ. σελίδα 24) και πιέστε το κουμπί **ΕΠΙΛΟΓΗΣ**.

Ο χρονοδιακόπτης On/Off δεν λειτουργεί στις ακόλουθες περιπτώσεις:

όταν ο χρονοδιακόπτης On/Off είναι απενεργοποιημένος, όταν υπάρχει σφάλμα, όταν διεξάγεται έλεγχος (στο μενού service), όταν διεξάγεται δοκιμή λειτουργίας, όταν διεξάγεται διαγνωστικός έλεγχος του τηλεχειριστηρίου, αν δεν έχει ρυθμιστεί το ρολόι, κατά τη ρύθμιση λειτουργίας, όταν το σύστημα ελέγχεται κεντρικά (όταν απαγορεύεται η λειτουργία On/Off ή η λειτουργία του χρονομετρητή από το τοπικό τηλεχειριστήριο).

2

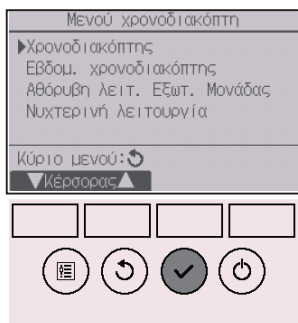

Μετακινήστε τον κέρσορα στο “Χρονοδιακόπτης” και πιέστε το κουμπί **ΕΠΙΛΟΓΗΣ**.

3

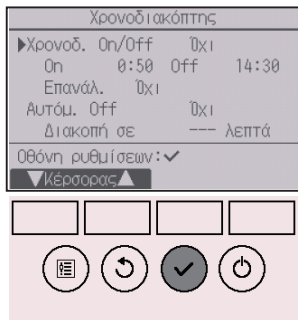

Θα εμφανιστούν οι τρέχουσες ρυθμίσεις.

Μετακινήστε τον κέρσορα στο “Χρονοδ. On/Off και πιέστε το κουμπί **ΕΠΙΛΟΓΗΣ**.

Ρυθμίσεις λειτουργίας

4



Θα εμφανιστεί η οθόνη για τη ρύθμιση του χρονοδιακόπτη.

Με το κουμπάκι [F1] ή [F2], επιλέξτε “Χρονοδ. On/Off”, “On”, “Off” ή “Επανάλ.”.

5

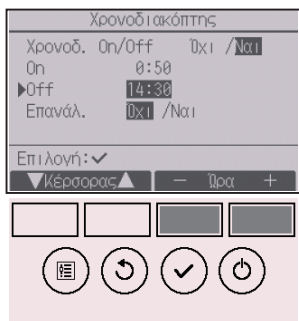

Αλλάξτε τη ρύθμιση με το κουμπάκι [F3] ή [F4].

- Χρονοδ. On/Off: Όχι (απενεργοποίηση)/ Ναι (ενεργοποίηση)
- On: Ωρα έναρξης λειτουργίας (ανά βήματα των 5 λεπτών)
* Κρατήστε πατημένο το κουμπάκι για να προχωρήσουν γρήγορα οι αριθμοί.
- Off: Ωρα διακοπής λειτουργίας (ανά βήματα των 5 λεπτών)
* Κρατήστε πατημένο το κουμπάκι για να προχωρήσουν γρήγορα οι αριθμοί.
- Επανάλ.: Όχι (μία φορά)/Ναι (επανάληψη)

6

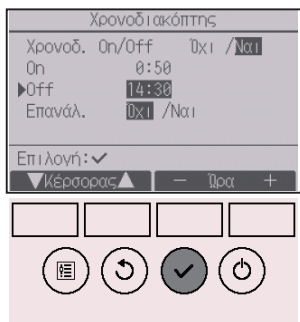

Πιέστε το κουμπί **ΕΠΙΛΟΓΗΣ** για να αποθηκευτούν οι ρυθμίσεις.

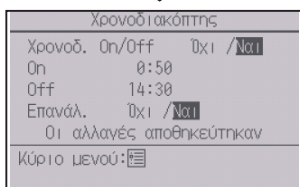



Θα εμφανιστεί μια οθόνη επιβεβαίωσης.

Πλοήγηση στις οθόνες

- Επιστροφή στο Κύριο μενού Κουμπί **ΜΕΝΟΥ**
- Επιστροφή στην προηγούμενη οθόνη... Κουμπί **ΕΠΙΣΤΡΟΦΗΣ**



 εμφανίζεται στην Οθόνη κατάστασης και στην Κύρια οθόνη στην Πλήρη προβολή όταν είναι ενεργοποιημένος ο Χρονοδιακόπτης On/Off.

 εμφανίζεται όταν ο χρονοδιακόπτης είναι απενεργοποιημένος από το κεντρικό σύστημα ελέγχου.

Ρυθμίσεις λειτουργίας

Χρονοδιακόπτης (Χρονοδιακόπτης Αυτόματου Off)



Λειτουργία κουμπιών

1

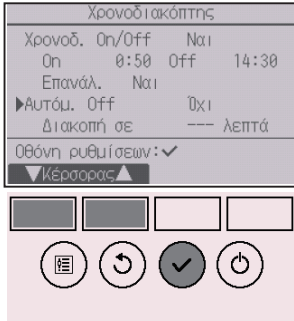

Περάστε στην οθόνη ρύθμισης του Χρονοδιακόπτη. (Βλ. σελίδα 29.)

Επιλέξτε “Αυτόμ. Off” και πιέστε το κουμπί **[ΕΠΙΛΟΓΗΣ]**.

Η ρύθμιση “Χρονοδιακόπτης Αυτόματου Off” δεν λειτουργεί στις ακόλουθες περιπτώσεις:
όταν η ρύθμιση “Χρονοδιακόπτης Αυτόματου Off” είναι απενεργοποιημένη, όταν υπάρχει σφάλμα, όταν διεξάγεται έλεγχος (στο μενού service), όταν διεξάγεται δοκιμή λειτουργίας, όταν διεξάγεται διαγνωστικός έλεγχος του τηλεχειριστηρίου, κατά τη ρύθμιση λειτουργίας, όταν το σύστημα ελέγχεται κεντρικά (όταν απαγορεύεται η λειτουργία On/Off ή η λειτουργία του χρονομετρητή από το τοπικό τηλεχειριστήριο).

2

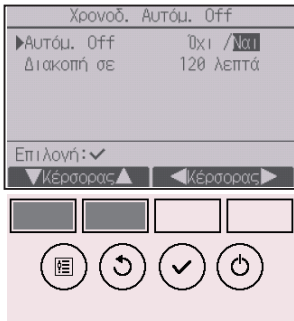

Θα εμφανιστούν οι τρέχουσες ρυθμίσεις.

Μετακινήστε τον κέρσορα στο “Αυτόμ. Off” ή στο “Διακοπή σε --- λεπτά” με το κουμπί **[F1]** ή **[F2]**.

3

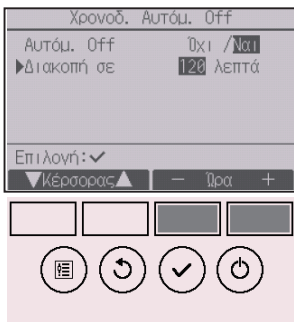

Αλλάξτε τη ρύθμιση με το κουμπί **[F3]** ή **[F4]**.

- Αυτόμ. Off: Όχι (απενεργοποίηση)/Ναι (ενεργοποίηση)
- Διακοπή σε --- λεπτά: Ρύθμιση του χρονοδιακόπτη (Το επιτρεπόμενο εύρος ρύθμισης είναι 30 έως 240 λεπτά ανά βήματα των 10 λεπτών.)

4

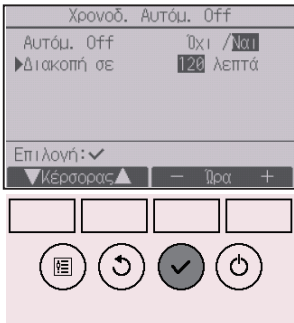

Πιέστε το κουμπί **ΕΠΙΛΟΓΗΣ** για να αποθηκευτούν οι ρυθμίσεις.

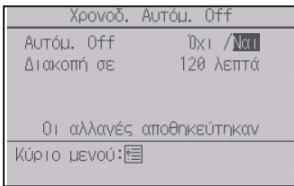



Θα εμφανιστεί μια οθόνη επιβεβαίωσης.

Πλοήγηση στις οθόνες

- Επιστροφή στο Κύριο μενού Κουμπί **ΜΕΝΟΥ**
- Επιστροφή στην προηγούμενη οθόνη... Κουμπί **ΕΠΙΣΤΡΟΦΗΣ**



 εμφανίζεται στην Οθόνη κατάστασης και στην Κύρια οθόνη στην πλήρη προβολή όταν είναι ενεργοποιημένος ο Χρονοδιακόπτης Αυτόματου Off.

 εμφανίζεται όταν ο χρονοδιακόπτης είναι απενεργοποιημένος από το κεντρικό σύστημα ελέγχου.

Ρυθμίσεις λειτουργίας

Εβδομαδιαίος χρονοδιακόπτης



Λειτουργία κουμπιών

1

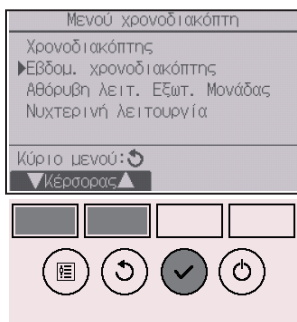

Επιλέξτε “Εβδομ. χρονοδιακόπτης” από το μενού του Χρονοδιακόπτη και πιέστε το κουμπί **[ΕΠΙΛΟΓΗΣ]**.

Ο Εβδομαδιαίος χρονοδιακόπτης δεν λειτουργεί στις ακόλουθες περιπτώσεις:

όταν ο χρονοδιακόπτης On/Off είναι ενεργοποιημένος, όταν ο εβδομαδιαίος χρονοδιακόπτης είναι απενεργοποιημένος, εάν υπάρχει σφάλμα, όταν διεξάγεται έλεγχος (στο μενού service), όταν διεξάγεται δοκιμή λειτουργίας, όταν διεξάγεται διαγνωστικός έλεγχος του τηλεχειριστηρίου, αν δεν έχει ρυθμιστεί το ρολόι, κατά τη ρύθμιση λειτουργίας, όταν το σύστημα ελέγχεται κεντρικά (όταν απαγορεύεται η λειτουργία On/Off, η ρύθμιση θερμοκρασίας ή η λειτουργία του χρονομετρητή από το τοπικό τηλεχειριστήριο).

2



Θα εμφανιστούν οι τρέχουσες ρυθμίσεις.

Πιέστε το κουμπί **[F1]** ή **[F2]** για να δείτε τις ρυθμίσεις για κάθε ημέρα της εβδομάδας.

Πιέστε το κουμπί **[F3]** για να δείτε τα μοτίβα 5 έως 8.

Πιέστε το κουμπί **[F4]** για να δείτε την κατάσταση της Ρύθμισης 2.

Πιέστε το κουμπί **[ΕΠΙΛΟΓΗΣ]** για να περάσετε στην οθόνη ρύθμισης.

3

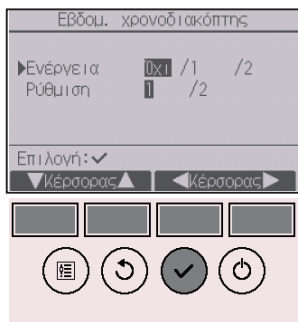

Θα εμφανιστεί η οθόνη ρυθμίσεων του εβδομαδιαίου χρονοδιακόπτη.

Στη ρύθμιση “Ενέργεια”, επιλέξτε “1” για να ενεργοποιήσετε τη ρύθμιση 1 του χρονοδιακόπτη ή επιλέξτε “2” για να ενεργοποιήσετε τη ρύθμιση 2 του χρονοδιακόπτη με το κουμπί **[F3]** ή **[F4]**. Μετά πιέστε το κουμπί **[ΕΠΙΛΟΓΗΣ]**.

Για να ελέγξετε το περιεχόμενο της ρύθμισης 1 ή 2 του χρονοδιακόπτη, μετακινήστε τον κέρσορα στην επιλογή “Ρύθμιση” με το κουμπί **[F1]** ή **[F2]** και επιλέξτε “1” ή “2” με το κουμπί **[F3]** ή **[F4]**.

4



Θα εμφανιστεί η οθόνη ρύθμισης του εβδομαδιαίου χρονοδιακόπτη και οι τρέχουσες ρυθμίσεις. Μπορούν να ρυθμιστούν έως οκτώ μοτίβα λειτουργίας για κάθε ημέρα.

Μετακινήστε τον κέρσορα στην επιθυμητή ημέρα της εβδομάδας με το κουμπί **[F1]** ή **[F2]** και πιέστε το κουμπί **[F3]** για να την επιλέξετε. (Μπορούν να επιλεγθούν πολλές ημέρες.)

Πιέστε το κουμπί **[ΕΠΙΛΟΓΗΣ]**.

Ρυθμίσεις λειτουργίας

5

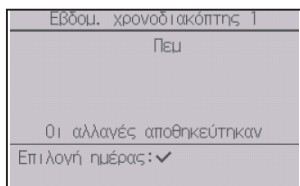

Θα εμφανιστεί η οθόνη ρύθμισης μοτίβου λειτουργίας. Πιέστε το κουμπί [F1] για να μετακινήσετε τον κέρσορα στον αριθμό του επιθυμητού μοτίβου.

Μετακινήστε τον κέρσορα στην ένδειξη ώρας, On/Off ή θερμοκρασίας με το κουμπί [F2].

Αλλάξτε τις ρυθμίσεις με το κουμπί [F3] ή [F4].

- Ωρα: ρυθμίζεται ανά βήματα των 5 λεπτών.
* Κρατήστε πατημένο το κουμπί για να προχωρήσουν γρήγορα οι αριθμοί.
 - On/Off/Αυτόμ.: Οι διαθέσιμες ρυθμίσεις εξαρτώνται από το μοντέλο της συνδεδεμένης εσωτερικής μονάδας. (Αν επιλεγθεί αυτόματο μοτίβο, το σύστημα θα τεθεί σε Αυτόματη λειτουργία (δύο θέσεων ρύθμισης).)
 - Θερμοκρασία: Το επιτρεπόμενο εύρος ρύθμισης της θερμοκρασίας διαφέρει ανάλογα με τις συνδεδεμένες εσωτερικές μονάδες. (Βήματα 1°C)
Αν επιλεγθεί η Αυτόματη λειτουργία (δύο θέσεων ρύθμισης), μπορείτε να ορίσετε δύο προ-ρυθμισμένες θερμοκρασίες. Αν ενεργοποιήσετε μοτίβο λειτουργίας που περιλαμβάνει μόνο μία προ-ρυθμισμένη τιμή θερμοκρασίας ενώ το σύστημα βρίσκεται σε Αυτόματη λειτουργία (δύο θέσεων ρύθμισης), η προ-ρυθμισμένη τιμή θα χρησιμοποιηθεί για τη θερμοκρασία ψύξης στη λειτουργία Ψύξης.
- Πιέστε το κουμπί [ΕΠΙΛΟΓΗΣ] για να αποθηκευτούν οι ρυθμίσεις.

Θα εμφανιστεί μια οθόνη επιβεβαίωσης.

Πλοήγηση στις οθόνες

- Επιστροφή στην οθόνη αλλαγής ρύθμισης/επιλογής ημέρας εβδομάδας Κουμπί [ΕΠΙΛΟΓΗΣ]
- Επιστροφή στο Κύριο μενού Κουμπί [ΜΕΝΟΥ]
- Επιστροφή στην προηγούμενη οθόνη ... Κουμπί [ΕΠΙΣΤΡΟΦΗΣ]



7 εμφανίζεται στην Οθόνη κατάστασης και στην Κύρια οθόνη στην Πλήρη προβολή όταν υπάρχει ρύθμιση του εβδομαδιαίου χρονοδιακόπτη για την τρέχουσα ημέρα.

Το εικονίδιο δεν εμφανίζεται όταν είναι ενεργοποιημένος ο χρονοδιακόπτης On/Off ή όταν το σύστημα ελέγχεται κεντρικά (απαγορεύεται η λειτουργία του χρονοδιακόπτη από το τοπικό τηλεχειριστήριο).

Περιγραφή λειτουργίας

Με αυτή τη λειτουργία μπορείτε να ρυθμίσετε χρονικές περιόδους κατά τις οποίες θα δίνεται προτεραιότητα στην αθόρυβη λειτουργία των εξωτερικών μονάδων έναντι του ελέγχου της θερμοκρασίας. Ρυθμίστε τις ώρες έναρξης και διακοπής της αθόρυβης λειτουργίας για κάθε ημέρα της εβδομάδας. Επιλέξτε το επιθυμητό επίπεδο αθόρυβης λειτουργίας μεταξύ των επιλογών “Μεσαίο” και “Αθόρυβο”.

Λειτουργία κουμπιών

1

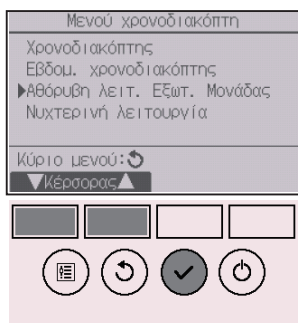

Επιλέξτε “Αθόρυβη λειτ. Εξωτ. Μονάδας” από το μενού του Χρονοδιακόπτη και πιέστε το κουμπί **ΕΠΙΛΟΓΗΣ**.

Η “Αθόρυβη λειτ. Εξωτ. Μονάδας” είναι διαθέσιμη μόνο στα μοντέλα που υποστηρίζουν αυτή τη λειτουργία.

2



Θα εμφανιστούν οι τρέχουσες ρυθμίσεις.

Πιέστε το κουμπί **F1** ή **F2** για να δείτε τις ρυθμίσεις για κάθε ημέρα της εβδομάδας.

Πιέστε το κουμπί **ΕΠΙΛΟΓΗΣ** για να περάσετε στην οθόνη ρύθμισης.

Ρυθμίσεις λειτουργίας

3



Θα εμφανιστεί η οθόνη για την ενεργοποίηση (Ναι) και απενεργοποίηση (Όχι) της αθόρυβης λειτουργίας.

Για να ενεργοποιήσετε αυτή τη ρύθμιση, μετακινήστε τον κέρσορα στο “Ναι” με το κουμπί **[F3]** ή **[F4]** και πιέστε το κουμπί **[ΕΠΙΛΟΓΗΣ]**.

4



Θα εμφανιστεί οθόνη ρύθμισης της Αθόρυβης λειτουργίας εξωτερικής μονάδας.

Για να πραγματοποιήσετε ή να αλλάξετε τη ρύθμιση, μετακινήστε τον κέρσορα στην επιθυμητή ημέρα της εβδομάδας με το κουμπί **[F1]** ή **[F2]** και πιέστε το κουμπί **[F3]** για να την επιλέξετε. (Μπορούν να επιλεγθούν πολλές ημέρες.)

Πιέστε το κουμπί **[ΕΠΙΛΟΓΗΣ]**.

5

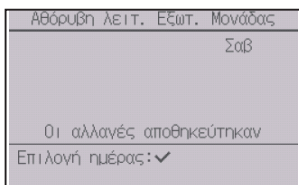
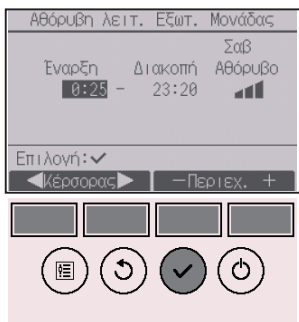

Θα εμφανιστεί η οθόνη ρύθμισης.

Μετακινήστε τον κέρσορα στο επιθυμητό στοιχείο με το κουμπί **[F1]** ή **[F2]** και επιλέξτε “Ωρα έναρξης”, “Ωρα διακοπής” ή επίπεδο αθόρυβης λειτουργίας (Αθόρυβο).

Αλλάξτε τις ρυθμίσεις με το κουμπί **[F3]** ή **[F4]**.

- Ωρα έναρξης/διακοπής: ρυθμίζεται ανά βήματα των 5 λεπτών.

- * Κρατήστε πατημένο το κουμπί για να προχωρήσουν γρήγορα οι αριθμοί.

- Επίπεδο αθόρυβου: Κανονικό, Μεσαίο, Αθόρυβο



Πιέστε το κουμπί **[ΕΠΙΛΟΓΗΣ]** για να αποθηκευτούν οι ρυθμίσεις. Θα εμφανιστεί μια οθόνη επιβεβαίωσης.

Πλοήγηση στις οθόνες

- Επιστροφή στην οθόνη αλλαγής ρύθμισης/επιλογής ημέρας εβδομάδας Κουμπί **[ΕΠΙΛΟΓΗΣ]**
- Επιστροφή στο Κύριο μενού Κουμπί **[ΜΕΝΟΥ]**
- Επιστροφή στην προηγούμενη οθόνη ... Κουμπί **[ΕΠΙΣΤΡΟΦΗΣ]**

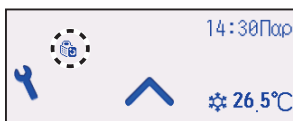

 εμφανίζεται στην Οθόνη κατάστασης και στην Κύρια οθόνη στην Πλήρη προβολή κατά την αθόρυβη λειτουργία εξωτερικής μονάδας.

Ρυθμίσεις λειτουργίας

Νυχτερινή λειτουργία



Περιγραφή λειτουργίας

Αυτή η ρύθμιση ξεκινά τη λειτουργία θέρμανσης όταν η ομάδα των ελεγχόμενων μονάδων είναι σταματημένη και η θερμοκρασία του δωματίου πέσει κάτω από το κατώτερο όριο προ-ρυθμισμένης θερμοκρασίας. Επίσης, αυτή η ρύθμιση ξεκινά τη λειτουργία ψύξης όταν η ομάδα των ελεγχόμενων μονάδων είναι σταματημένη και η θερμοκρασία του δωματίου ανέβει πάνω από το ανώτερο όριο προ-ρυθμισμένης θερμοκρασίας.

Η Νυχτερινή λειτουργία δεν είναι διαθέσιμη αν οι ρυθμίσεις λειτουργίας και θερμοκρασίας πραγματοποιούνται από το τηλεχειριστήριο.

Αν η θερμοκρασία του δωματίου μετράται από τον αισθητήρα θερμοκρασίας αναρρόφησης του κλιματιστικού, μπορεί να μην ανιχνεύεται η ακριβής θερμοκρασία όταν το κλιματιστικό είναι ανενεργό ή όταν ο αέρας δεν είναι καθαρός. Σε αυτή την περίπτωση, επιλέξτε έναν απομακρυσμένο αισθητήρα (PAC-SE40TSA/PAC-SE41TS-E) ή έναν αισθητήρα του τηλεχειριστηρίου.

Λειτουργία κουμπιών

1

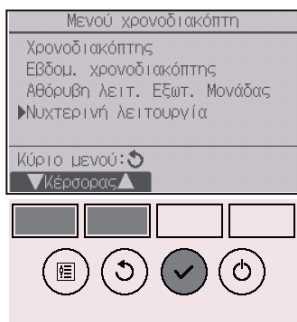

Επιλέξτε “Νυχτερινή λειτουργία” από το μενού του Χρονοδιακόπτη και πιέστε το κουμπί **ΕΠΙΛΟΓΗΣ**.

2

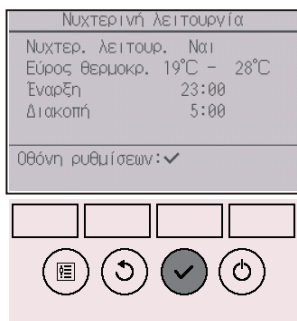

Θα εμφανιστούν οι τρέχουσες ρυθμίσεις.

Πιέστε το κουμπί **ΕΠΙΛΟΓΗΣ** για να περάσετε στην οθόνη ρύθμισης.

3

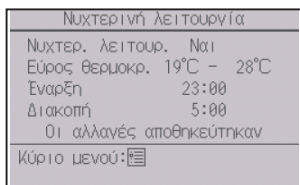
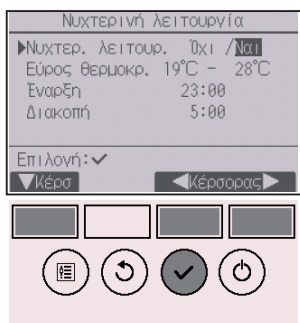

Μετακινήστε τον κέρσορα στο επιθυμητό στοιχείο με το κουμπί [F1] ή [F2] και επιλέξτε “Nυχτερινή λειτουργία” Όχι (απενεργοποίηση)/Ναι (ενεργοποίηση), Εύρος θερμοκρασίας, Ώρα έναρξης ή Ώρα διακοπής.

Αλλάξτε τις ρυθμίσεις με το κουμπί [F3] ή [F4].

- Εύρος θερμοκρ.: Μπορείτε να ρυθμίσετε το κατώτερο όριο θερμοκρασίας (για τη λειτουργία θέρμανσης) και το ανώτερο όριο θερμοκρασίας (για τη λειτουργία ψύξης). Η διαφορά θερμοκρασίας μεταξύ κατώτερου και ανώτερου ορίου πρέπει να είναι 4°C (8°F) ή μεγαλύτερη. Το επιτρεπόμενο εύρος ρύθμισης της θερμοκρασίας διαφέρει ανάλογα με τις συνδεδεμένες εσωτερικές μονάδες.
* Βήματα 1°C
- Ώρα έναρξης/διακοπής: ρυθμίζεται ανά βήματα των 5 λεπτών.
* Κρατήστε πατημένο το κουμπί για να προχωρήσουν γρήγορα οι αριθμοί.

Πιέστε το κουμπί [ΕΠΙΛΟΓΗΣ] για να αποθηκευτούν οι ρυθμίσεις.

Θα εμφανιστεί μια οθόνη επιβεβαίωσης.

Πλοήγηση στις οθόνες

- Επιστροφή στο Κύριο μενού Κουμπί [ΜΕΝΟΥ]
- Επιστροφή στην προηγούμενη οθόνη ... Κουμπί [ΕΠΙΣΤΡΟΦΗΣ]

Ρυθμίσεις λειτουργίας



⌘ εμφανίζεται στην Οθόνη κατάστασης και στην Κύρια οθόνη σε Πλήρη προβολή όταν είναι ενεργοποιημένη η Νυχτερινή λειτουργία.

⌘ εμφανίζεται όταν ο χρονοδιακόπτης είναι απενεργοποιημένος από το κεντρικό σύστημα ελέγχου.

Η Νυχτερινή λειτουργία δεν λειτουργεί στις ακόλουθες περιπτώσεις:

όταν λειτουργεί η μονάδα, όταν είναι απενεργοποιημένη η Νυχτερινή λειτουργία, εάν υπάρχει σφάλμα, όταν διεξάγεται έλεγχος (στο μενού service), όταν διεξάγεται δοκιμή λειτουργίας, όταν διεξάγεται διαγνωστικός έλεγχος του τηλεχειριστηρίου, αν δεν έχει ρυθμιστεί το ρολόι, κατά τη ρύθμιση λειτουργίας, όταν το σύστημα ελέγχεται κεντρικά (όταν απαγορεύεται η λειτουργία On/Off, η ρύθμιση θερμοκρασίας ή η λειτουργία του χρονομετρητή από το τοπικό τηλεχειριστήριο).

Ρύθμιση περιορισμού εύρους θερμοκρασίας

Λειτουργία κουμπιών

1



Επιλέξτε “Εξοικονόμηση ενέργειας” από το Κύριο μενού (βλ. σελίδα 24) και πιέστε το κουμπί **ΕΠΙΛΟΓΗΣ**.

2



Μετακινήστε τον κέρσρα στην επιλογή “Περιορισμός” με το κουμπί **F1** ή **F2** και πιέστε το κουμπί **ΕΠΙΛΟΓΗΣ**.

Ρυθμίσεις λειτουργίας

3



Θα εμφανιστούν οι τρέχουσες ρυθμίσεις.

Μετακινήστε τον κέρσορα στο “Εύρος θερμοκρ.” με το κουμπί **F1** ή **F2** και πιάστε το κουμπί **ΕΠΙΛΟΓΗΣ**.

4

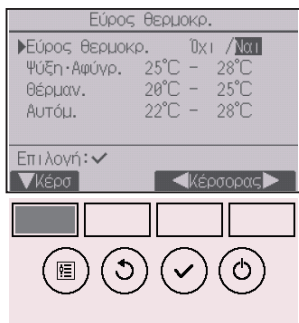

Θα εμφανιστεί η οθόνη ρύθμισης του εύρους θερμοκρασίας.

Μετακινήστε τον κέρσορα στο επιθυμητό στοιχείο με το κουμπί **F1** και επιλέξτε “Εύρος θερμοκρ.”, “Ψύξη·Αφύγρ.”, “Θέρμαν.” ή “Αυτόμ.”.

5

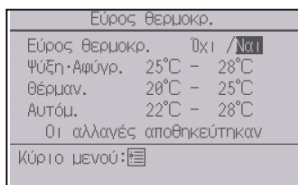

Αλλάξτε τις ρυθμίσεις με το κουμπί [F3] ή [F4].

- Εύρος θερμοκρ.: Όχι (μη περιορισμένο) ή Ναι (περιορισμένο)
- Ψύξη·Αφύγρ.: Άνω και κάτω όριο θερμοκρασίας (βήματα 1°C)
- Θέρμαν.: Άνω και κάτω όριο θερμοκρασίας (βήματα 1°C)
- Αυτόμ.: Άνω και κάτω όριο θερμοκρασίας (βήματα 1°C)

Εύρη ρύθμισης θερμοκρασίας

Λειτουργία	Κάτω όριο	Άνω όριο
Ψύξη·Αφύγρانش *1 *3	19 ~ 30°C (67 ~ 87°F)	30 ~ 19°C (87 ~ 67°F)
Θέρμανση *2 *3	17 ~ 28°C (63 ~ 83°F)	28 ~ 17°C (83 ~ 63°F)
Αυτόματο *4	19 ~ 28°C (67 ~ 83°F)	28 ~ 19°C (83 ~ 67°F)

* Το επιτρεπόμενο εύρος ρύθμισης διαφέρει ανάλογα με τη συνδεδεμένη μονάδα.

*1 Μπορείτε να ρυθμίσετε τα εύρη θερμοκρασίας για Ψύξη, Αφύγρانش και Αυτόματη λειτουργία (δύο θέσεων ρύθμισης).

*2 Μπορείτε να ρυθμίσετε τα εύρη θερμοκρασίας για Θέρμανση και Αυτόματη λειτουργία (δύο θέσεων ρύθμισης).

*3 Τα εύρη θερμοκρασίας για Θέρμανση, Ψύξη και Αφύγρانش πρέπει να ικανοποιούν τις ακόλουθες προϋποθέσεις:

- Άνω όριο ψύξης - άνω όριο θέρμανσης \geq ελάχιστη διαφορά θερμοκρασίας (διαφέρει ανάλογα με το μοντέλο εσωτερικής μονάδας)
- Κάτω όριο ψύξης - κάτω όριο θέρμανσης \geq ελάχιστη διαφορά θερμοκρασίας (διαφέρει ανάλογα με το μοντέλο εσωτερικής μονάδας)

*4 Μπορείτε να ρυθμίσετε το εύρος θερμοκρασίας για την Αυτόματη λειτουργία (μίας θέσης ρύθμισης).

Πιέστε το κουμπί [ΕΠΙΛΟΓΗΣ] για να αποθηκευτούν οι ρυθμίσεις.

Θα εμφανιστεί μια οθόνη επιβεβαίωσης.

Πλοήγηση στις οθόνες

- Επιστροφή στο Κύριο μενού Κουμπί [ΜΕΝΟΥ]
- Επιστροφή στην προηγούμενη οθόνη ... Κουμπί [ΕΠΙΣΤΡΟΦΗΣ]



 εμφανίζεται στην Οθόνη κατάστασης και στην Κύρια οθόνη στην Πλήρη προβολή όταν το εύρος θερμοκρασίας είναι περιορισμένο.

Ρυθμίσεις λειτουργίας

Περιορισμός



Κλείδωμα λειτουργίας

Λειτουργία κουμπιών

Για να ενεργοποιήσετε το κλείδωμα λειτουργίας, ρυθμίστε την επιλογή “Λειτ. κλειδωμένη” σε “Ναι”.

1



Περάστε στην οθόνη ρύθμισης Περιορισμού. (Βλ. σελίδα 43.)

Μετακινήστε τον κέρσορα στην επιλογή “Λειτ. κλειδωμένη” και πιέστε το κουμπί **ΕΠΙΛΟΓΗΣ**.

2

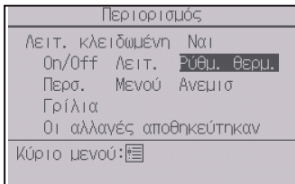

Θα εμφανιστεί η οθόνη ρυθμίσεων για το κλείδωμα λειτουργίας.

Μετακινήστε τον κέρσορα στο επιθυμητό στοιχείο με το κουμπί [F1] ή [F2] και επιλέξτε “Λειτουργία κλειδωμένη”, “Τοποθεσία”, “On/Off”, “Λειτουργία”, “Ρύθμ. θερμ.”, “Μενού”, “Ανεμισ”, “Γρίλια” ή “Περσίδα”.

Αλλάξτε τις ρυθμίσεις με το κουμπί [F3] ή [F4].

- Λειτουργία κλειδωμένη: Όχι (απενεργοποίηση)/ Ναι (ενεργοποίηση)
- Τοποθεσία: “Ανεξ.” ή “Ξενοδ.”
- On/Off: Λειτουργία ενεργοποίησης/ απενεργοποίησης
- Λειτουργία: Ρύθμιση κατάστασης λειτουργίας
- Ρύθμ. θερμ.: Ρύθμιση προ-ρυθμισμένης θερμοκρασίας
- Περσίδα: Ρύθμιση περσίδας
- Μενού: Ρύθμιση μενού
- Ανεμισ: Ρύθμιση ταχύτητας ανεμιστήρα
- Γρίλια: Ρύθμιση γρίλιας

Αν επιλεγθεί “Ξενοδ.” για τη ρύθμιση “Τοποθεσία”, οι ακόλουθες λειτουργίες θα κλειδωθούν αυτόματα: Λειτουργία, Περσίδα, Μενού και Γρίλια.

Πιέστε το κουμπί [ΕΠΙΛΟΓΗΣ] για να αποθηκευτούν οι ρυθμίσεις.

Θα εμφανιστεί μια οθόνη επιβεβαίωσης.

Πλοήγηση στις οθόνες

- Επιστροφή στο Κύριο μενού Κουμπί [ΜΕΝΟΥ]
- Επιστροφή στην προηγούμενη οθόνη ... Κουμπί [ΕΠΙΣΤΡΟΦΗΣ]

Ρυθμίσεις λειτουργίας



 εμφανίζεται στην Οθόνη κατάστασης και στην Κύρια οθόνη στην Πλήρη προβολή όταν έχει ενεργοποιηθεί κλείδωμα λειτουργίας.

Ο οδηγός λειτουργίας που αντιστοιχεί στην κλειδωμένη λειτουργία δεν θα εμφανίζεται.

Για να εμφανίσετε το κύριο μενού όταν έχει κλειδωθεί η ρύθμιση των μενού, κρατήστε πατημένο το κουμπί ρύθμισης για δέκα ή περισσότερα δευτερόλεπτα. Καταχωρίστε τον κωδικό διαχειριστή στην οθόνη εισαγωγής κωδικού πρόσβασης.

Αυτόματη επιστροφή στην προ-ρυθμισμένη θερμοκρασία

Αφού ενεργοποιηθεί η λειτουργία Αυτόματης επιστροφής, αν χρησιμοποιηθεί αυτό το τηλεχειριστήριο για να αλλάξει η κατάσταση λειτουργίας ή για να ενεργοποιηθούν/απενεργοποιηθούν οι μονάδες, η ρύθμιση θερμοκρασίας θα επανέλθει αυτόματα στην απαιτούμενη θερμοκρασία ανεξάρτητα από τη ρύθμιση χρόνου που θα έχει οριστεί.

Λειτουργία κουμπιών

1

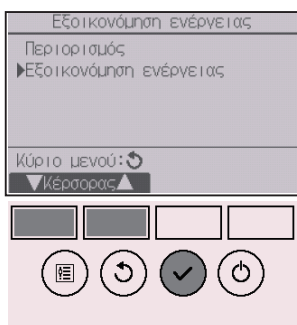

Επιλέξτε “Εξοικονόμηση ενέργειας” από το μενού εξοικονόμησης ενέργειας και πιέστε το κουμπί **ΕΠΙΛΟΓΗΣ**.

2



Θα εμφανιστούν οι τρέχουσες ρυθμίσεις.

Μετακινήστε τον κέρσορα στην επιλογή “Αυτόμ. επιστροφή” με το κουμπί **F1** ή **F2** και πιέστε το κουμπί **ΕΠΙΛΟΓΗΣ**.

Ρυθμίσεις λειτουργίας

3



Θα εμφανιστεί η οθόνη ρυθμίσεων για αυτόματη επιστροφή στην προ-ρυθμισμένη θερμοκρασία.

Μετακινήστε τον κέρσορα στο επιθυμητό στοιχείο με το κουμπί [F1] ή [F2] και επιλέξτε “Αυτόμ.επιστροφή”, “Ψύξη” ή “Θέρμ.”.

4



Αλλάζτε τις ρυθμίσεις με το κουμπί [F3] ή [F4].

- Αυτόμ.επιστροφή: Όχι (απενεργοποίηση)/Ναι (ενεργοποίηση)
- Ψύξη: Το εύρος ρύθμισης του χρονοδιακόπτη είναι 30 έως 120 λεπτά ανά βήματα των 10 λεπτών.
Το εύρος ρύθμισης της θερμοκρασίας είναι 19 έως 30°C (67 έως 87°F) (ανά βήματα 1°C)
- Θέρμ.: Το εύρος ρύθμισης του χρονοδιακόπτη είναι 30 έως 120 λεπτά ανά βήματα των 10 λεπτών.
Το εύρος ρύθμισης της θερμοκρασίας είναι 17 έως 28°C (63 έως 83°F) (ανά βήματα 1°C)

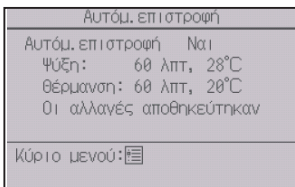

Πιέστε το κουμπί [ΕΠΙΛΟΓΗΣ] για να αποθηκευτούν οι ρυθμίσεις. Η “Ψύξη” περιλαμβάνει τις λειτουργίες “Αφύγρ.” και “Αυτόμ. Ψύξη” και η “Θέρμ.” περιλαμβάνει τη λειτουργία “Αυτόμ. Θέρμαν.”. Θα εμφανιστεί η οθόνη για τη ρύθμιση του επιλεγμένου στοιχείου.

Πλοήγηση στις οθόνες

- Επιστροφή στο Κύριο μενού Κουμπί [ΜΕΝΟΥ]
- Επιστροφή στην προηγούμενη οθόνη... Κουμπί [ΕΠΙΣΤΡΟΦΗΣ]

Οι ρυθμίσεις που αφορούν τον χρονοδιακόπτη ή την προ-ρυθμισμένη θερμοκρασία δεν θα εφαρμόζονται όταν υπάρχει περιορισμός του εύρους θερμοκρασίας και όταν το σύστημα ελέγχεται κεντρικά (όταν απαγορεύεται η ρύθμιση του εύρους θερμοκρασίας από το τοπικό χειριστήριο). Όταν το σύστημα ελέγχεται κεντρικά (όταν απαγορεύεται η λειτουργία του χρονοδιακόπτη από το τοπικό τηλεχειριστήριο), μόνο η ρύθμιση του χρονοδιακόπτη δεν θα εφαρμόζεται.

Ρύθμιση του προγράμματος εξοικονόμησης ενέργειας

Λειτουργία κουμπιών

1



Περάστε στην οθόνη “Εξοικονόμηση ενέργειας”. (Βλ. σελίδα 49.)

Μετακινήστε τον κέρσορα στο “Πρόγραμμα” και πιέστε το κουμπί **ΕΠΙΛΟΓΗΣ**.

2

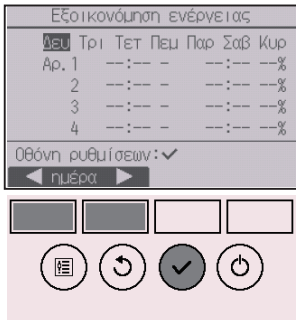

Θα εμφανιστεί η οθόνη προβολής του προγράμματος.

Πιέστε το κουμπί **F1** ή **F2** για να δείτε τις ρυθμίσεις για κάθε ημέρα της εβδομάδας.

Πιέστε το κουμπί **ΕΠΙΛΟΓΗΣ** για να περάσετε στην οθόνη ρύθμισης.

3

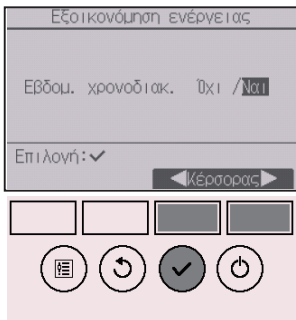

Θα εμφανιστεί η οθόνη ενεργοποίησης (Ναι)/ απενεργοποίησης (Όχι) του προγράμματος εξοικονόμησης ενέργειας.

Επιλέξτε “Όχι” ή “Ναι” με το κουμπί **F3** ή **F4**.

Πιέστε το κουμπί **ΕΠΙΛΟΓΗΣ** για να περάσετε στην οθόνη αλλαγής ρύθμισης/επιλογής ημέρας της εβδομάδας.

Ρυθμίσεις λειτουργίας

4



Θα εμφανιστεί η οθόνη αλλαγής ρύθμισης/επιλογής ημέρας της εβδομάδας.

Μπορείτε να ρυθμίσετε έως τέσσερα μοτίβα λειτουργίας για κάθε ημέρα της εβδομάδας.

Μετακινήστε τον κέρσορα στην επιθυμητή ημέρα της εβδομάδας με το κουμπί **[F1]** ή **[F2]** και πιέστε το κουμπί **[F3]** για να την επιλέξετε. (Μπορούν να επιλεγθούν πολλές ημέρες.)

Πιέστε το κουμπί **[ΕΠΙΛΟΓΗΣ]** για να περάσετε στην οθόνη ρύθμισης μοτίβου.

5



Θα εμφανιστεί η οθόνη ρύθμισης μοτίβου.

Πιέστε το κουμπί **[F1]** για να μετακινήσετε τον κέρσορα στον αριθμό του επιθυμητού μοτίβου.

Μετακινήστε τον κέρσορα στο επιθυμητό στοιχείο με το κουμπί **[F2]** και επιλέξτε ώρα έναρξης, ώρα διακοπής και βαθμό εξοικονόμησης ενέργειας (με αυτή τη σειρά από αριστερά).

Αλλάξτε τις ρυθμίσεις με το κουμπί **[F3]** ή **[F4]**.

- Ώρα έναρξης/διακοπής: ρυθμίζεται ανά βήματα των 5 λεπτών.

- * Κρατήστε πατημένο το κουμπί για να προχωρήσουν γρήγορα οι αριθμοί.

- Βαθμός εξοικονόμησης ενέργειας: Το εύρος ρύθμισης είναι 0% και 50 έως 90% ανά βήματα του 10%.

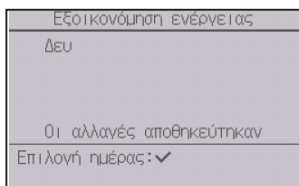

Πιέστε το κουμπί **[ΕΠΙΛΟΓΗΣ]** για να αποθηκευτούν οι ρυθμίσεις.

Θα εμφανιστεί μια οθόνη επιβεβαίωσης.

Όσο πιο χαμηλή είναι η τιμή, τόσο πιο μεγάλη θα είναι η εξοικονόμηση ενέργειας.



 εμφανίζεται στην Οθόνη κατάσταση και στην Κύρια οθόνη στην Πλήρη προβολή όταν η μονάδα λειτουργεί σε κατάσταση εξοικονόμησης ενέργειας.

Πλοήγηση στις οθόνες

- Επιστροφή στην οθόνη αλλαγής ρύθμισης/επιλογής ημέρας εβδομάδας Κουμπί **ΕΠΙΛΟΓΗΣ**
- Επιστροφή στο Κύριο μενού Κουμπί **ΜΕΝΟΥ**
- Επιστροφή στην προηγούμενη οθόνη ... Κουμπί **ΕΠΙΣΤΡΟΦΗΣ**

Ρυθμίσεις λειτουργίας

Ρολόι



Λειτουργία κουμπιών

1

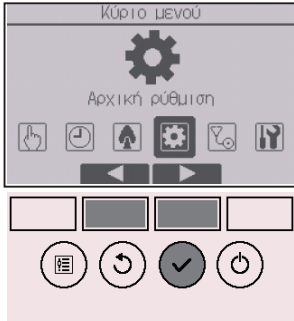

Επιλέξτε “Αρχική ρύθμιση” από το Κύριο μενού (βλ. σελίδα 24) και πιέστε το κουμπί **ΕΠΙΛΟΓΗΣ**.

Το ρολόι πρέπει να έχει ρυθμιστεί πριν γίνουν οι ακόλουθες ρυθμίσεις.

- Χρονοδιακόπτης On/Off
- Εβδομαδιαίος χρονοδιακόπτης
- Αθόρυβη λειτουργία
- Εξοικονόμηση ενέργειας
- Εξωτερικής μονάδας
- Νυχτερινή λειτουργία

Αν το σύστημα δεν διαθέτει ελεγκτές συστήματος, η ώρα του ρολογιού δεν θα διορθωθεί αυτόματα. Σε αυτή την περίπτωση, να διορθώνετε περιοδικά την ώρα του ρολογιού.

2



Μετακινήστε τον κέρσορα στην επιλογή “Βασική ρύθμιση” με το κουμπί **F1** ή **F2** και πιέστε το κουμπί **ΕΠΙΛΟΓΗΣ**.

3

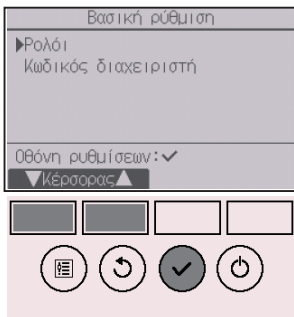

Επιλέξτε “Ρολόι” με το κουμπί **F1** ή **F2** και πιέστε το κουμπί **ΕΠΙΛΟΓΗΣ**.

4

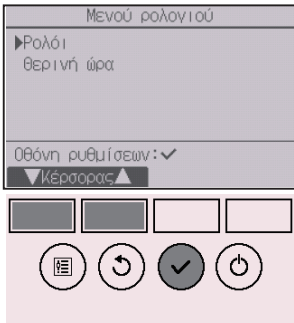

Μετακινήστε τον κέρσορα στο “Ρολόι” με το κουμπί [F1] ή [F2] και πιάστε το κουμπί [ΕΠΙΛΟΓΗΣ].

5



Μετακινήστε τον κέρσορα στο επιθυμητό στοιχείο με το κουμπί [F1] ή [F2] και επιλέξτε έτος, μήνα, ημέρα, ώρα ή λεπτά.

Αυξομειώστε την τιμή του επιλεγμένου στοιχείου με το κουμπί [F3] ή [F4] και πιάστε το κουμπί [ΕΠΙΛΟΓΗΣ]. Θα εμφανιστεί μια οθόνη επιβεβαίωσης.

Πλοήγηση στις οθόνες

- Επιστροφή στο Κύριο μενού Κουμπί [ΜΕΝΟΥ]
- Επιστροφή στην προηγούμενη οθόνη ... Κουμπί [ΕΠΙΣΤΡΟΦΗΣ]

Ρυθμίσεις λειτουργίας

Θερινή ώρα



Περιγραφή λειτουργίας

Η ώρα έναρξης/λήξης για τη θερινή ώρα μπορεί να ρυθμιστεί. Η λειτουργία θερινής ώρας θα ενεργοποιηθεί με βάση τα περιεχόμενα της ρύθμισης.

- Εάν ένα δεδομένο σύστημα έχει έναν ελεγκτή συστήματος, απενεργοποιήστε αυτή τη ρύθμιση για να διατηρήσετε τη σωστή ώρα.
- Στην αρχή και στο τέλος της θερινής ώρας, ο χρονοδιακόπτης μπορεί να τεθεί σε λειτουργία δύο φορές ή και καθόλου.
- Η λειτουργία αυτή δεν θα λειτουργήσει παρά μόνον αν έχει ρυθμιστεί το ρολόι.

Λειτουργία κουμπιών

1

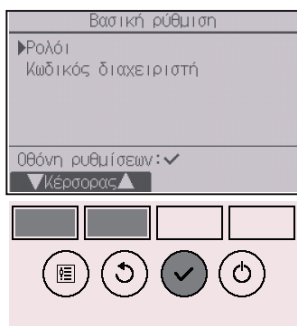

Επιλέξτε “Ρολόι” από το μενού Βασικής ρύθμισης και πιέστε το κουμπί **ΕΠΙΛΟΓΗΣ**.

2

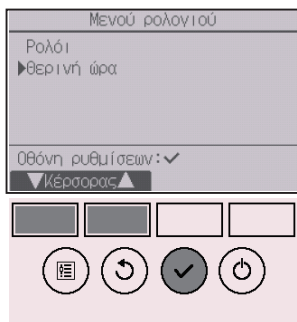

Μετακινήστε τον κέρσορα στην επιλογή “Θερινή ώρα” με το κουμπί **F1** ή **F2** και πιέστε το κουμπί **ΕΠΙΛΟΓΗΣ**.

3

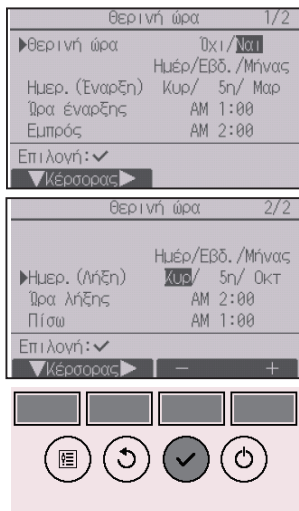

Μετακινήστε τον κέρσορα στις ακόλουθες επιλογές με το κουμπί **[F1]** για να πραγματοποιήσετε τις ρυθμίσεις.

- **Θερινή ώρα**
Επιλέξτε "Όχι" (απενεργοποίηση) ή "Ναι" (ενεργοποίηση) με το κουμπί **[F2]**. Η προεπιλεγμένη ρύθμιση είναι "Όχι".
 - **Ημερ.(Εναρξη)*1**
Ρυθμίστε την ημέρα της εβδομάδας, τον αριθμό της εβδομάδας και το μήνα με το κουμπί **[F3]** ή **[F4]**. Η προεπιλεγμένη ρύθμιση είναι "Κυρ/5η/Μαρ".
 - **Ώρα έναρξης**
Ρυθμίστε την ώρα έναρξης της θερινής ώρας με το κουμπί **[F3]** ή **[F4]**.
 - **Εμπρός**
Ρυθμίστε την ώρα στην οποία θα πρέπει να πάει μπροστά το ρολόι κατά την παραπάνω ώρα έναρξης με το κουμπί **[F3]** ή **[F4]**.
 - **Ημερ.(Λήξη)*1 (2η σελίδα)**
Ρυθμίστε την ημέρα της εβδομάδας, τον αριθμό της εβδομάδας και το μήνα με το κουμπί **[F3]** ή **[F4]**. Η προεπιλεγμένη ρύθμιση είναι "Κυρ/5η/Οκτ".
 - **Ώρα λήξης (2η σελίδα)**
Ρυθμίστε την ώρα λήξης της θερινής ώρας με το κουμπί **[F3]** ή **[F4]**.
 - **Πίσω (2η σελίδα)**
Ρυθμίστε την ώρα στην οποία θα πρέπει να πάει πίσω το ρολόι κατά την παραπάνω ώρα λήξης με το κουμπί **[F3]** ή **[F4]**.
- *1 Αν επιλεγθεί "5η" για τον αριθμό εβδομάδας και ο επιλεγμένος μήνας του έτους δεν έχει 5η εβδομάδα, το σύστημα θα θεωρήσει ότι έχει επιλεγθεί η "4η" εβδομάδα.

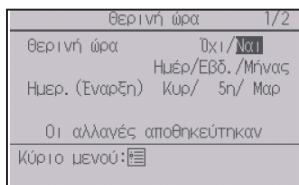

Πιέστε το κουμπί **[ΕΠΙΛΟΓΗΣ]** για να αποθηκευτούν οι ρυθμίσεις.
Θα εμφανιστεί μια οθόνη επιβεβαίωσης.

Πλοήγηση στις θόκες

- Επιστροφή στο Κύριο μενού Κουμπί **[MENOY]**
- Επιστροφή στην προηγούμενη οθόνη ... Κουμπί **[ΕΠΙΣΤΡΟΦΗΣ]**

Ρυθμίσεις λειτουργίας

Κύρια οθόνη



Λειτουργία κουμπιών

1



Επιλέξτε “Ρύθμιση οθόνης” από το μενού αρχικών ρυθμίσεων και πιέστε το κουμπί **ΕΠΙΛΟΓΗΣ**.

2

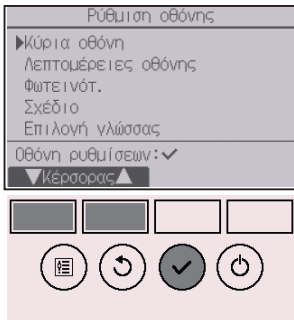

Μετακινήστε τον κέρσορα στην “Κύρια οθόνη” με το κουμπί **F1** ή **F2** και πιέστε το κουμπί **ΕΠΙΛΟΓΗΣ**.

3



Επιλέξτε “Πλήρης” ή “Βασική” (βλ. σελίδα 10) με το κουμπί **F3** ή **F4** και πιέστε το κουμπί **ΕΠΙΛΟΓΗΣ**.

Θα εμφανιστεί μια οθόνη επιβεβαίωσης.

Πλοήγηση στις οθόνες

- Επιστροφή στο Κύριο μενού Κουμπί **ΜΕΝΟΥ**
- Επιστροφή στην προηγούμενη οθόνη... Κουμπί **ΕΠΙΣΤΡΟΦΗΣ**

Λειτουργία κουμπιών

1

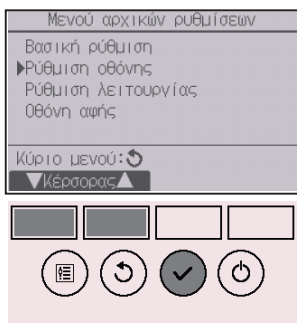

Επιλέξτε “Ρύθμιση οθόνης” από το μενού αρχικών ρυθμίσεων και πιέστε το κουμπί **ΕΠΙΛΟΓΗΣ**.

2

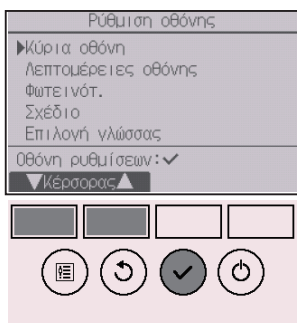

Μετακινήστε τον κέρσορα στην “Κύρια οθόνη” με το κουμπί **F1** ή **F2** και πιέστε το κουμπί **ΕΠΙΛΟΓΗΣ**.

3



Επιλέξτε “Επεξ. εικονιδ.” με το κουμπί **F1** ή **F2**, επιλέξτε την επιθυμητή ρύθμιση “Ναι” ή “Όχι” με το κουμπί **F3** ή **F4** και πιέστε το κουμπί **ΕΠΙΛΟΓΗΣ**. Η προεπιλεγμένη ρύθμιση είναι “Ναι”.

Πλοήγηση στις οθόνες

- Επιστροφή στο Κύριο μενού Κουμπί **ΜΕΝΟΥ**
- Επιστροφή στην προηγούμενη οθόνη... Κουμπί **ΕΠΙΣΤΡΟΦΗΣ**

Ρυθμίσεις λειτουργίας

4

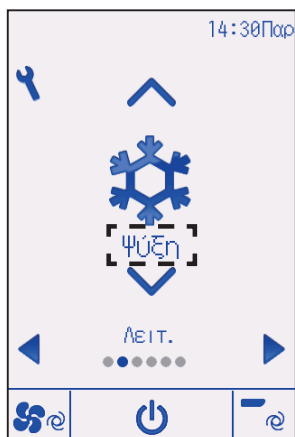

Αν επιλεγθεί “Ναι”, θα εμφανίζεται επεξήγηση για το εικονίδιο του στοιχείου ρύθμισης όπως φαίνεται στην εικόνα αριστερά.

Λειτουργία κουμπιών

1



Επιλέξτε “Ρύθμιση οθόνης” από το μενού αρχικών ρυθμίσεων και πιέστε το κουμπί **[ΕΠΙΛΟΓΗΣ]**.

2

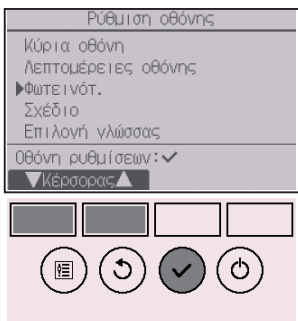

Μετακινήστε τον κέρσορα στην επιλογή “Φωτεινότη.” με το κουμπί **[F1]** ή **[F2]** και πιέστε το κουμπί **[ΕΠΙΛΟΓΗΣ]**.

3



Ρυθμίστε τη φωτεινότητα με το κουμπί **[F1]** ή **[F2]**. Μπορείτε να επιλέξετε “On” ή “Off” για τη ρύθμιση “Αναμμένο” με το κουμπί **[F4]**.

Όταν επιλέγεται “ON”, ο οπίσθιος φωτισμός θα παραμείνει αμυδρά αναμμένος ακόμη και μετά το πέρασμα του προσδιορισμένου χρόνου.

Πλοήγηση στις οθόνες

- Επιστροφή στο Κύριο μενού Κουμπί **[ΜΕΝΟΥ]**
- Επιστροφή στην προηγούμενη οθόνη ... Κουμπί **[ΕΠΙΣΤΡΟΦΗΣ]**

Ρυθμίσεις λειτουργίας

Επιλογή γλώσσας



Περιγραφή λειτουργίας

Μπορείτε να επιλέξετε την επιθυμητή γλώσσα. Οι επιλογές γλώσσας είναι Αγγλικά, Γαλλικά, Γερμανικά, Ισπανικά, Ιταλικά, Πορτογαλικά, Σουηδικά, Ρωσικά, Ελληνικά, Τουρκικά, Ολλανδικά, Τσέχικα, Ουγγρικά και Πολωνικά.

Λειτουργία κουμπιών

1



Επιλέξτε “Ρύθμιση οθόνης” από το μενού αρχικών ρυθμίσεων και πιάστε το κουμπί **ΕΠΙΛΟΓΗΣ**.

2

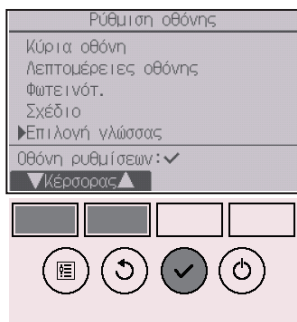

Μετακινήστε τον κέρσορα στην “Επιλογή γλώσσας” με το κουμπί **F1** ή **F2** και πιάστε το κουμπί **ΕΠΙΛΟΓΗΣ**.

3



Μετακινήστε τον κέρσορα στην επιθυμητή γλώσσα με τα κουμπιά **F1** έως **F4** και πιάστε το κουμπί **ΕΠΙΛΟΓΗΣ** για να αποθηκευτεί η ρύθμιση.

Κατά την αρχική ενεργοποίηση, εμφανίζεται η οθόνη επιλογής Γλώσσας. Επιλέξτε την επιθυμητή γλώσσα. Το σύστημα δεν θα εκκινήσει χωρίς επιλογή γλώσσας.

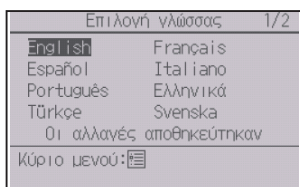

Θα εμφανιστεί μια οθόνη που δείχνει ότι η ρύθμιση αποθηκεύτηκε.

Πλοήγηση στις οθόνες

- Επιστροφή στο Κύριο μενού Κουμπί **ΜΕΝΟΥ**
- Επιστροφή στην προηγούμενη οθόνη ... Κουμπί **ΕΠΙΣΤΡΟΦΗΣ**

Ρυθμίσεις λειτουργίας

Σχέδιο



Λειτουργία κουμπιών

1



Επιλέξτε “Ρύθμιση οθόνης” από το μενού αρχικών ρυθμίσεων και πιέστε το κουμπί **[ΕΠΙΛΟΓΗΣ]**.

2

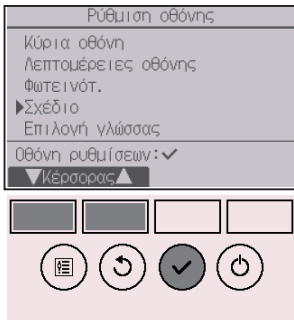

Μετακινήστε τον κέρσορα στο “Σχέδιο” με το κουμπί **[F1]** ή **[F2]** και πιέστε το κουμπί **[ΕΠΙΛΟΓΗΣ]**.

3



Επιλέξτε “Χρώμα” με το κουμπί **[F4]**.

- Χρώμα: Το χρώμα οθόνης μπορεί να επιλεγεί. (Βλ. επόμενη σελίδα.)
- Άσπρο: Μονόχρωμη οθόνη (άσπρο φόντο)
- Μαύρο: Μονόχρωμη οθόνη (μαύρο φόντο)

Αν επιλέξετε “Άσπρο” ή “Μαύρο”, πιέστε το κουμπί **[ΕΠΙΛΟΓΗΣ]**. Αν επιλέξετε “Χρώμα”, ανατρέξτε στην επόμενη σελίδα για να επιλέξετε το επιθυμητό χρώμα.

4

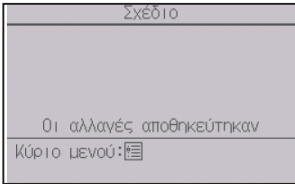

Επιλέξτε τα ακόλουθα στοιχεία με το κουμπί **[F1]** ή **[F2]** και ρυθμίστε το επιθυμητό χρώμα της οθόνης για κάθε επιμέρους στοιχείο.

- Χρωματική απόχρωση: Ρυθμίστε την χρωματική απόχρωση με το κουμπί **[F3]** ή **[F4]**. (Το εύρος δυνατών ρυθμίσεων είναι -90 έως 89.)
- Μοτίβο: Ρυθμίστε το χρώμα με το κουμπί **[F4]**.
- Ρύθμ.χρώμ. σε: Επιλέξτε "Χαρακτήρας" ή "Φόντο" με το κουμπί **[F4]** για να ορίσετε πού θα εφαρμοστεί το χρώμα.

Η χρωματική ένδειξη κάτω από τα κουμπιά λειτουργίας θα αλλάξει ανάλογα με τη ρύθμιση.

Ρυθμίστε το επιθυμητό χρώμα και πιέστε το κουμπί **[ΕΠΙΛΟΓΗΣ]**.

Πλοήγηση στις οθόνες

- Επιστροφή στο Κύριο μενού Κουμπί **[ΜΕΝΟΥ]**
- Επιστροφή στην προηγούμενη οθόνη ... Κουμπί **[ΕΠΙΣΤΡΟΦΗΣ]**

Ρυθμίσεις λειτουργίας

Βαθμονόμηση οθόνης αφής



Λειτουργία κουμπιών

1



Επιλέξτε “Οθόνη αφής” από το μενού αρχικών ρυθμίσεων και πιέστε το κουμπί **[ΕΠΙΛΟΓΗΣ]**.

2

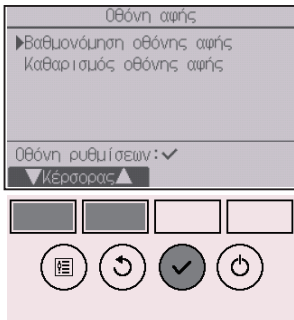

Μετακινήστε τον κέρσορα στην “Βαθμονόμηση οθόνης αφής” με το κουμπί **[F1]** ή **[F2]** και πιέστε το κουμπί **[ΕΠΙΛΟΓΗΣ]**.

3

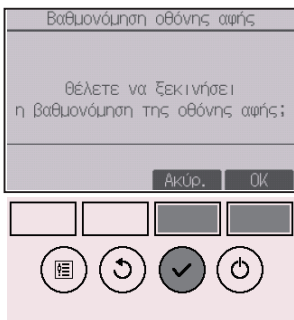

Θα εμφανιστεί μια οθόνη επιβεβαίωσης. Επιλέξτε “Ακύρ.” ή “OK” με το κουμπί **[F3]** ή **[F4]** και πιέστε το κουμπί **[ΕΠΙΛΟΓΗΣ]**.

4

Αγγίξτε τις μαύρες κουκκίδες ώστε να εμφανιστούν στην οθόνη. Θα είναι εννέα όλες μαζί.

Αγγίξτε τις μαύρες κουκκίδες με ένα στυλό αφής εντός ενός λεπτού, ξεκινώντας από την επάνω δεξιά γωνία.

Αγγίξτε τις εννέα μαύρες κουκκίδες με τη σειρά που θα εμφανιστούν στην οθόνη.

Μόλις αγγίξετε και τις εννέα μαύρες κουκκίδες, η βαθμονόμηση θα έχει ολοκληρωθεί και η οθόνη θα επιστρέψει στο μενού της οθόνης αφής.

- Αν δεν αγγίξετε την οθόνη αφής για ένα λεπτό, η βαθμονόμηση θα ακυρωθεί και η οθόνη θα επιστρέψει αυτόματα στην προηγούμενη οθόνη.
- Για να βαθμονομήσετε σωστά την οθόνη αφής, χρησιμοποιήστε ένα μυτερό, αλλά όχι αιχμηρό αντικείμενο για να αγγίξετε τις κουκκίδες.
 - * Αν το αντικείμενο είναι αιχμηρό, μπορεί να υποστεί ζημιά ή να χαραχτεί η οθόνη αφής.

Ρυθμίσεις λειτουργίας

Καθαρισμός οθόνης αφής



Λειτουργία κουμπιών

1

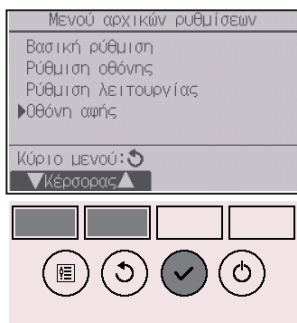

Επιλέξτε “Οθόνη αφής” από το μενού αρχικών ρυθμίσεων και πιέστε το κουμπί **[ΕΠΙΛΟΓΗΣ]**.

2



Μετακινήστε τον κέρσορα στην επιλογή “Καθαρισμός οθόνης αφής” με το κουμπί **[F1]** ή **[F2]** και πιέστε το κουμπί **[ΕΠΙΛΟΓΗΣ]**.

3

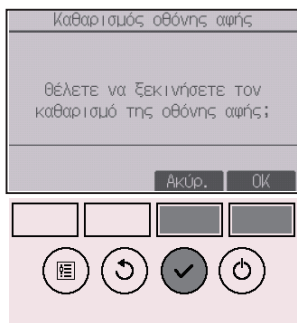

Θα εμφανιστεί μια οθόνη επιβεβαίωσης. Επιλέξτε “Ακύρ.” ή “OK” με το κουμπί **[F3]** ή **[F4]** και πιέστε το κουμπί **[ΕΠΙΛΟΓΗΣ]**.

4



Αυτή η οθόνη σας επιτρέπει να σκουπίσετε την οθόνη αφής για 30 δευτερόλεπτα, χωρίς να αλλάξετε κατά λάθος τις ρυθμίσεις.

Η οθόνη θα επιστρέψει στο μενού της οθόνης αφής μετά από 30 δευτερόλεπτα.

- Σκουπίστε την οθόνη με ένα στεγνό μαλακό πανί, με ένα πανί εμποτισμένο με νερό και ήπιο απορρυπαντικό ή με ένα πανί εμποτισμένο με αιθανόλη. Μην χρησιμοποιείτε όξινους, αλκαλικούς ή οργανικούς διαλύτες.

Ρυθμίσεις λειτουργίας

Αρχικοποίηση τηλεχειριστηρίου



Περιγραφή λειτουργίας

Μπορείτε να επαναφέρετε το τηλεχειριστήριο στις αρχικές εργοστασιακές ρυθμίσεις. Η αρχικοποίηση αφορά τα δεδομένα που αναφέρονται παρακάτω.

Το τηλεχειριστήριο θα ενεργοποιηθεί αυτόματα μετά την αρχικοποίηση.

Ρύθμιση χρονοδιακόπτη, ρύθμιση εβδομαδιαίου χρονοδιακόπτη, ρύθμιση αθόρυβης λειτουργίας εξωτερικής μονάδας, ρύθμιση εξοικονόμησης ενέργειας, ρύθμιση επιλογής εξοικονόμησης ενέργειας, ρύθμιση ρολογιού, ρύθμιση θερινής ώρας, ρύθμιση κύριας οθόνης, ρύθμιση φωτεινότητας, ρύθμιση λεπτομερειών οθόνης, ρύθμιση σχεδίου, ρύθμιση αυτόματης λειτουργίας, ρύθμιση ονόματος μοντέλου, ρύθμιση αριθμός σειράς, ρύθμιση στοιχείων αντιπροσώπου, πληροφορίες σφάλματος, κωδικός διαχειριστή, κωδικός συντήρησης

Λειτουργία κουμπιών

1



Επιλέξτε “Αλλα” στο μενού service και πιέστε το κουμπί **[ΕΠΙΛΟΓΗΣ]**.

2

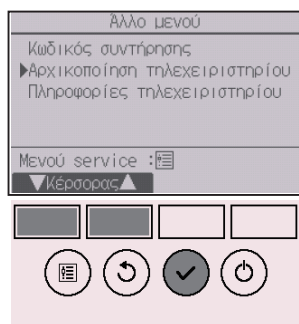

Μετακινήστε τον κέρσορα στην επιλογή “Αρχικοποίηση τηλεχειριστηρίου” με το κουμπί **[F1]** ή **[F2]** και πιέστε το κουμπί **[ΕΠΙΛΟΓΗΣ]**.

3

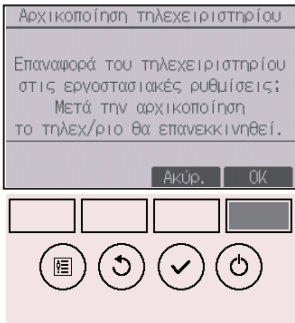

Επιλέξτε “OK” με το κουμπί **F4**.

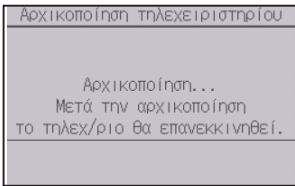

Το τηλεχειριστήριο θα ενεργοποιηθεί αυτόματα μετά την αρχικοποίηση.

Ρυθμίσεις λειτουργίας

Πληροφορίες τηλεχειριστηρίου



Περιγραφή λειτουργίας

Μπορείτε να δείτε πληροφορίες για το τηλεχειριστήριο που χρησιμοποιείται.

Λειτουργία κουμπιών

1

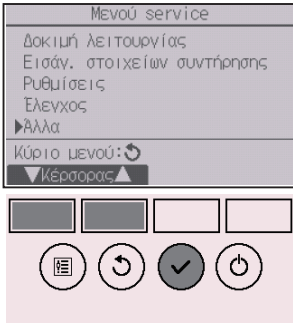

Επιλέξτε “Αλλα” στο μενού service και πιέστε το κουμπί **ΕΠΙΛΟΓΗΣ**.

2

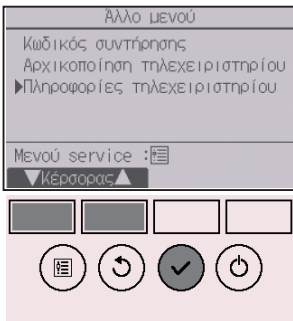

Μετακινήστε τον κέρσορα στην επιλογή “Πληροφορίες τηλεχειριστηρίου” με το κουμπί **F1** ή **F2** και πιέστε το κουμπί **ΕΠΙΛΟΓΗΣ**.

3



Μπορείτε να δείτε το όνομα μοντέλου, την έκδοση λογισμικού (S/W Ver) και τον αριθμό σειράς του τηλεχειριστηρίου που χρησιμοποιείται.

Αντιμετώπιση προβλημάτων

Πληροφορίες σφάλματος

Όταν παρουσιάζεται σφάλμα, εμφανίζεται η ακόλουθη οθόνη και αναβοσβήνει η λυχνία LED λειτουργίας. Ελέγξτε την κατάσταση του σφάλματος, σταματήστε τη λειτουργία της μονάδας και απευθυνθείτε στον αντιπρόσωπο.

Λειτουργία κουμπιών

1

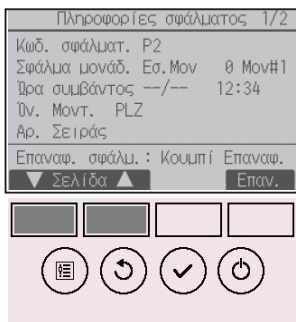

Στην οθόνη θα εμφανίζονται οι ακόλουθες πληροφορίες: κωδικός σφάλματος, σφάλμα μονάδας, διεύθυνση ψυκτικού, όνομα μοντέλου μονάδας, ημερομηνία και ώρα εμφάνισης του σφάλματος και αριθμός σειράς.

Το όνομα μοντέλου και ο αριθμός σειράς θα εμφανιστούν μόνο αν έχουν καταχωριστεί οι αντίστοιχες πληροφορίες.

Πιέστε το κουμπί **F1** ή **F2** για να περάσετε στην επόμενη σελίδα.

Οι πληροφορίες επαφής (τηλέφωνο αντιπροσώπου) θα εμφανιστούν αν έχουν καταχωριστεί.

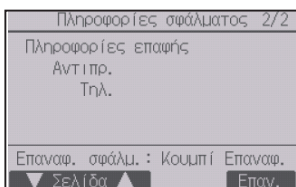

2

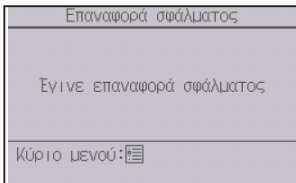
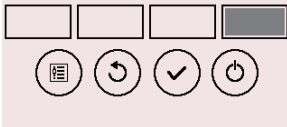
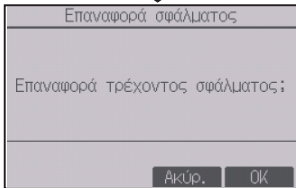
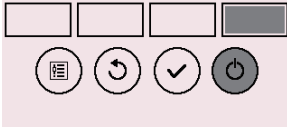
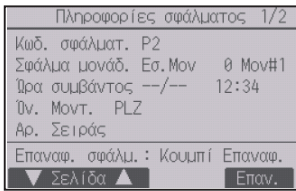

Πιέστε το κουμπί **F4** ή το κουμπί **ON/OFF** για επαναφορά του ενεργού σφάλματος.

Δεν είναι δυνατή η επαναφορά των σφαλμάτων αν απαγορεύεται η λειτουργία ON/OFF.

Επιλέξτε "OK" με το κουμπί **F4**.

Θα εμφανιστεί μια οθόνη επιβεβαίωσης.

Πλοήγηση στις οθόνες

- Επιστροφή στο Κύριο μενού Κουμπί **MENΟΥ**

Αντιμετώπιση προβλημάτων

Έλεγχος των πληροφοριών σφάλματος



Όταν δεν υπάρχουν ενεργά σφάλματα, μπορείτε να δείτε τη σελίδα 2/2 των πληροφοριών σφάλματος (βλ. σελίδα 74) μέσω των μενού. Επιλέξτε μενού “Συντήρηση” από το Κύριο μενού και πιάστε το κουμπί **ΕΠΙΛΟΓΗΣ**.

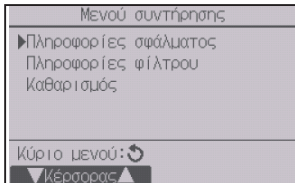

Για να εμφανιστεί η οθόνη πληροφοριών σφάλματος, επιλέξτε “Πληροφορίες σφάλματος” από το Μενού συντήρησης. Δεν είναι δυνατή η επαναφορά σφαλμάτων.

Αυτόματη απενεργοποίηση κενού δωματίου

Η ακόλουθη οθόνη θα εμφανιστεί στο μοντέλο με κάλυμμα 3D i-See sensor αν διακοπεί η λειτουργία της μονάδας από τη ρύθμιση αυτόματης απενεργοποίησης κενού δωματίου που περιλαμβάνεται στην επιλογή εξοικονόμησης ενέργειας. Ανατρέξτε στο Βιβλίο Οδηγιών της εσωτερικής μονάδας για τη ρύθμιση του 3D i-See sensor.

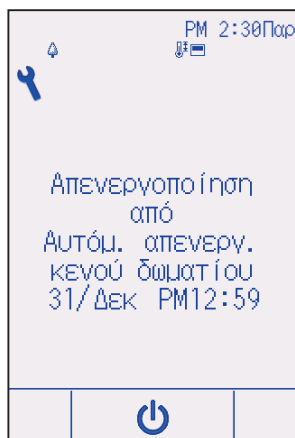

Συντήρηση

Πληροφορίες φίλτρου



 εμφανίζεται στην Οθόνη κατάστασης και στην Κύρια οθόνη στην Πλήρη προβολή όταν πρέπει να καθαριστούν τα φίλτρα.

Μόλις εμφανιστεί αυτή η ένδειξη, πλύνετε, καθαρίστε ή αντικαταστήστε τα φίλτρα. Ανατρέξτε στο Εγχειρίδιο οδηγιών της εσωτερικής μονάδας για αναλυτικές πληροφορίες.

Λειτουργία κουμπιών

1

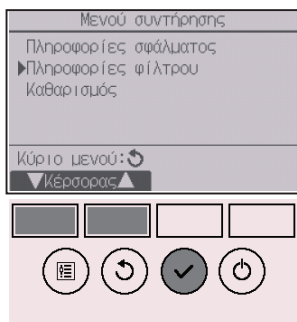

Επιλέξτε "Πληροφορίες φίλτρου" από το Μενού συντήρησης και πιέστε το κουμπί **[ΕΠΙΛΟΓΗΣ]**.

2

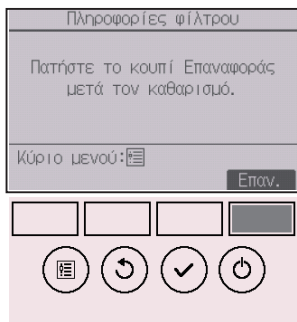

Πιέστε το κουμπί **[F4]** για να επαναφέρετε το σύμβολο του φίλτρου.

Ανατρέξτε στο Εγχειρίδιο οδηγιών της εσωτερικής μονάδας για τον τρόπο καθαρισμού του φίλτρου.

3

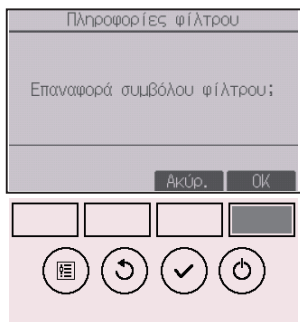

Επιλέξτε “OK” με το κουμπί **F4**.

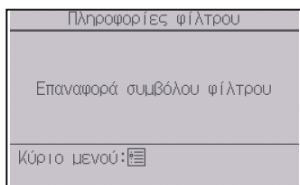

Θα εμφανιστεί μια οθόνη επιβεβαίωσης.

Πλοήγηση στις οθόνες

- Επιστροφή στο Κύριο μενού Κουμπί **MENΟΥ**
- Επιστροφή στην προηγούμενη οθόνη ... Κουμπί **ΕΠΙΣΤΡΟΦΗΣ**



Όταν εμφανίζεται η ένδειξη  στην Οθόνη κατάστασης και στην Κύρια οθόνη στην Πλήρη προβολή, το σύστημα ελέγχεται κεντρικά και δεν είναι δυνατή η επαναφορά του συμβόλου του φίλτρου.

Αν έχουν συνδεθεί δύο ή περισσότερες εσωτερικές μονάδες, ο χρόνος καθαρισμού του φίλτρου κάθε επιμέρους μονάδας μπορεί να διαφέρει ανάλογα με τον τύπο του φίλτρου.

Το εικονίδιο  εμφανίζεται όταν απαιτείται καθαρισμός του φίλτρου στην κύρια μονάδα.

Όταν γίνεται επαναφορά του συμβόλου του φίλτρου, μηδενίζεται και ο αθροιστικός χρόνος λειτουργίας για όλες τις μονάδες.

Το εικονίδιο  είναι προγραμματισμένο να εμφανίζεται μετά από ορισμένη διάρκεια λειτουργίας, με την προϋπόθεση ότι οι εσωτερικές μονάδες είναι εγκατεστημένες σε χώρο με φυσιολογική ποιότητα αέρα. Ανάλογα με την ποιότητα του αέρα, ενδέχεται να απαιτείται συχνότερος καθαρισμός του φίλτρου.

Ο αθροιστικός χρόνος μετά τον οποίο απαιτείται καθαρισμός του φίλτρου εξαρτάται από το μοντέλο.

Τεχνικά χαρακτηριστικά

Τεχνικά χαρακτηριστικά τηλεχειριστηρίου

	Τεχνικά χαρακτηριστικά
Μέγεθος προϊόντος	Standard (PAR-CT01MAA(R)-SB/PAR-CT01MAA-S): 65(Π) × 120(Υ) × 14,1(B) mm (2 9/16 × 4 23/32 × 9/16 [ίντσες]) (δεν περιλαμβάνεται το προεξέχον τμήμα)
	Premium (PAR-CT01MAA(R)-PB): 68(Π) × 120(Υ) × 14,1(B) mm (2 11/16 × 4 23/32 × 9/16 [ίντσες]) (δεν περιλαμβάνεται το προεξέχον τμήμα)
Καθαρό βάρος	Standard (PAR-CT01MAA(R)-SB/PAR-CT01MAA-S): 0,09 kg (13/64 lbs)
	Premium (PAR-CT01MAA(R)-PB): 0,10 kg (7/32 lbs)
Ονομαστική τάση ηλεκτρικής τροφοδοσίας	12 VDC (παρέχεται από τις εσωτερικές μονάδες)
Κατανάλωση ισχύος	0,6 W
Περιβάλλον χρήσης	Θερμοκρασία 0 ~ 40°C (32 ~ 104°F) Υγρασία 25 ~ 90%RH (μη συμπυκνούμενη)
Υλικό	Standard (PAR-CT01MAA(R)-SB/PAR-CT01MAA-S) Κυρίως σώμα: ABS
	Premium (PAR-CT01MAA(R)-PB) Κυρίως σώμα: ABS Πλευρικό κάλυμμα: Αλουμίνιο

Κατάλογος λειτουργιών (από 1 Οκτωβρίου 2017)

○ : Υποστηρίζεται × : Δεν υποστηρίζεται

	Λειτουργία	CITY MULTI	Mr. SLIM	Απαιτείται κωδικός
Ενεργοποίηση	Ενεργοποίηση/Απενεργοποίηση (ON/OFF)	○	○	-
Ρυθμίσεις	Κατάσταση λειτουργίας	○	○	-
	Αυτόματο (δύο θέσεις ρύθμισης)	○	○	-
	Προ-ρυθμισμένη θερμοκρασία	○	○	-
	Ταχύτητα ανεμιστήρα	○	○	-
	Περσίδα	○	○	-
	Γρίλια	○	○	-
	Εξαερισμός	○	○	-
Μενού λειτουργίας	Ισχυρό	×	○	-
	Χειροκίνητη γωνία περσίδας	○	○	-
	3D i-See sensor	○	○	-
Μενού χρονοδιακόπτη	Χρονοδιακόπτης (Χρονοδιακόπτης On/Off)	○	○	διαχειριστής
	Χρονοδιακόπτης (Χρονοδιακόπτης Αυτόματου Off)	○	○	διαχειριστής
	Εβδομαδιαίος χρονοδιακόπτης	○	○	διαχειριστής
	Αθόρυβη λειτουργία εξωτερικής μονάδας	○	○	διαχειριστής
	Νυχτερινή λειτουργία	○	○	διαχειριστής
Μενού εξοικονόμησης ενέργειας	Περιορισμός εύρους θερμοκρασίας	○	○	διαχειριστής
	Κλειδωμα λειτουργίας	○	○	διαχειριστής
	Αυτόματη επιστροφή	○	○	διαχειριστής
	Πρόγραμμα	×	○	διαχειριστής
Μενού αρχικών ρυθμίσεων	Ρολόι	○	○	διαχειριστής
	Ρύθμιση μορφής οθόνης ρολογιού	○	○	διαχειριστής
	Θερμική ώρα	○	○	διαχειριστής
	Κύρια οθόνη	○	○	διαχειριστής
	Επεξήγηση εικονιδίων	○	○	διαχειριστής
	Φωτεινότητα	○	○	διαχειριστής
	Επιλογή γλώσσας	○	○	διαχειριστής
	Σχέδιο	○	○	διαχειριστής
	Βαθμονόμηση οθόνης αφής	○	○	διαχειριστής
	Καθαρισμός οθόνης αφής	○	○	διαχειριστής
	Κωδικός (διαχειριστή)	○	○	διαχειριστής
Μενού service	Αρχιβοποίηση τηλεχειριστηρίου	○	○	συντήρηση
	Πληροφορίες τηλεχειριστηρίου	○	○	συντήρηση
	Δοκιμή λειτουργίας	○	○	συντήρηση
	Εισαγωγή στοιχείων μοντέλου	○	○	συντήρηση
	Εισαγωγή στοιχείων αντιπροσώπου	○	○	συντήρηση
	Ρύθμιση λειτουργίας	○	○	συντήρηση
	Ομαλή συντήρηση	×	○	συντήρηση
Μενού συντήρησης	Κωδικός (συντήρησης)	○	○	συντήρηση
	Κάλυμμα αυτόματης καθόδου	○	○	-
	Πληροφορίες σφάλματος	○	○	-
	Πληροφορίες φίλτρου	○	○	-

* Οι υποστηριζόμενες λειτουργίες μπορεί να διαφέρουν ανάλογα με το μοντέλο της μονάδας.

Τεχνικά χαρακτηριστικά

Λίστα λειτουργιών που μπορούν/δεν μπορούν να χρησιμοποιηθούν σε συνδυασμό

	Ισχυρό	Χρονοδιακόπτης On/Off	Χρονοδιακόπτης Αυτόματου Off	Εβδομαδιαίος χρονοδιακόπτης	Αθόρυβη λειτουργία εξωτερικής μονάδας	Εύρος θερμοκρασίας	Κλειδωμα λειτουργίας	Αυτόματη επιστροφή	Πρόγραμμα εξοικονόμησης ενέργειας	Νυχτερινή λειτουργία
Ισχυρό		○	○	○	△ 1	○	△ 2	○	△ 1	○
Χρονοδιακόπτης On/Off	○		○	× 1	○	○	○	○	○	△ 3
Χρονοδιακόπτης Αυτόματου Off	○	○		○	○	○	○	○	○	△ 4
Εβδομαδιαίος χρονοδιακόπτης	○	× 1	○		○	○	○	○	○	△ 5
Αθόρυβη λειτουργία εξωτερικής μονάδας	△ 1	○	○	○		○	○	○	○	○
Εύρος θερμοκρασίας	○	○	○	○	○		○	× 2	○	△ 6
Κλειδωμα λειτουργίας	△ 2	○	○	○	○	○		○	○	○
Αυτόματη επιστροφή	○	○	○	○	○	× 2	○		○	△ 7
Πρόγραμμα εξοικονόμησης ενέργειας	△ 1	○	○	○	○	○	○	○		○
Νυχτερινή λειτουργία	○	△ 3	△ 4	△ 5	○	△ 6	○	△ 7	○	

○ : Μπορεί να χρησιμοποιηθεί σε συνδυασμό × : Δεν μπορεί να χρησιμοποιηθεί σε συνδυασμό △ : Περιορισμένο

- △ 1: Αυτή η λειτουργία ενεργοποιείται αφού ολοκληρωθεί η Ισχυρή λειτουργία, διότι η ισχυρή λειτουργία έχει υψηλότερη προτεραιότητα.
- △ 2: Αυτή η λειτουργία δεν επιτρέπεται αν υπάρχει άλλη λειτουργία κλειδωμένη.
- △ 3: Η Νυχτερινή λειτουργία δεν μπορεί να χρησιμοποιηθεί όταν η μονάδα λειτουργεί με βάση τη ρύθμιση του χρονοδιακόπτη On/Off.
- △ 4: Η λειτουργία Αυτόματο Off δεν μπορεί να χρησιμοποιηθεί για τη Νυχτερινή λειτουργία.
- △ 5: Η Νυχτερινή λειτουργία δεν μπορεί να χρησιμοποιηθεί όταν η μονάδα λειτουργεί με βάση τη ρύθμιση του εβδομαδιαίου χρονοδιακόπτη.
- △ 6: Η ρύθμιση εύρους θερμοκρασίας δεν μπορεί να χρησιμοποιηθεί για τη Νυχτερινή λειτουργία.
- △ 7: Η λειτουργία αυτόματης επιστροφής δεν μπορεί να χρησιμοποιηθεί για τη Νυχτερινή λειτουργία.
- × 1: Η ρύθμιση του εβδομαδιαίου χρονοδιακόπτη δεν λειτουργεί διότι η ρύθμιση Χρονοδιακόπτη On/Off έχει υψηλότερη προτεραιότητα.
- × 2: Η λειτουργία αυτόματης επιστροφής δεν μπορεί να χρησιμοποιηθεί διότι η ρύθμιση εύρους θερμοκρασίας έχει υψηλότερη προτεραιότητα.

CITY MULTI Kontrol Sistemi
ve Mitsubishi Mr. SLIM Klimalar

MA Dokunmatik Uzaktan Kumanda

PAR-CT01MAA-PB

PAR-CT01MAA-SB

PAR-CT01MAA-S

PAR-CT01MAR-PB

PAR-CT01MAR-SB

Talimat Kılavuzu

Türkçe



Ürünü doğru biçimde kullanabilmek için kullanmadan önce bu kılavuzdaki talimatları dikkatlice okuyun.

İleride başvurmak için saklayın.

Bu CD-ROM'un ve Montaj Kılavuzunun gelecek kullanıcılara teslim edildiğinden emin olun.



Güvenliği ve uzaktan kumandanın düzgün çalışmasını sağlamak için, uzaktan kumanda yalnızca uzman personel tarafından monte edilmelidir.

İçindekiler

Güvenlik önlemleri	4
Kumanda bileşenleri	6
Kumanda arayüzü - Durum ekranı/Ana ekran	6
Kumanda arayüzü - Menü ekranı	8
Ekran - Durum ekranı/Ana ekran	10
Menü yapısı ve simgeler	12
Menü yapısı	12
Simge açıklamaları	15
Temel işlemler	16
Güç AÇIK/KAPALI	16
Çalışma modu, sıcaklık, fan hızı, kanat, iç kanat, ve havalandırma (Lossnay) ayarları	17
Menüde gezinme	22
Ana menü listesi	22
Ana menüde gezinme	24
İşlev ayarları	25
Yüksek Güç	25
Manuel kanat açısı	26
Zamanlayıcı (Açma/Kapama zamanlayıcı)	29
Zamanlayıcı (Otomatik kapanma zamanlayıcı)	32
Haftalık zamanlayıcı	34
Dış ünite sessiz modu	37
Gece ayarı	40
Kısıtlama	43
Enerji tasarrufu	49
Saat	54
Yaz saati uygulaması	56
Ana ekran	58
Simge açıklaması	59
Parlaklık	61
Dil seçimi	62
Tasarım	64
Dokunmatik panel kalibrasyonu	66
Dokunmatik panel temizleme	68
Uzaktan kumandayı sıfırla	70
Uzaktan kumanda bilgisi	72
Sorun Giderme	74
Hata bilgisi	74
Doluluk yok-otomatik kapanma	77
Bakım	78
Filtre bilgisi	78
Teknik Özellikler	80
Kumanda teknik özellikleri	80
İşlev listesi (1 Ekim 2017 itibarıyla)	81
Bir arada kullanılabilen/kullanılmayan işlevlerin listesi	82

Güvenlik önlemleri

- Üniteyi kullanmadan önce aşağıdaki güvenlik önlemlerini baştan sona okuyun.
- Güvenliği sağlamak için bu önlemlere dikkatli bir şekilde riayet edin.

 UYARI	Ölüm tehlikesi veya ciddi yaralanma riski olduğunu gösterir.
 DİKKAT	Ciddi bir yaralanma veya yapısal bir hasar riski olduğunu gösterir.

- Bu kılavuzu okuduktan sonra, gelecekte başvuru amacıyla son kullanıcıya teslim edin.
- Bu kılavuzu gelecekte başvuru amacıyla muhafaza edin ve gerektiğinde müracaat edin. Bu kılavuz, kumandayı onaran veya yer değişikliği yapan kişilere de verilmelidir. Kılavuzun gelecek kullanıcılara teslim edildiğinden emin olun.

Genel önlemler

UYARI

Üniteyi yüksek miktarda yağ, buhar, organik çözücüler veya sülfürük gaz gibi korozif gazların bulunduğu veya asidik/alkali çözeltiler veya spreylerin sık sık kullanıldığı yerlere monte etmeyin. Bu maddeler ünitenin performansını tehlikeye sokabilir veya birime ait bazı parçaların paslanmasına, dolayısıyla elektrik çarpması, arıza, duman veya yangına neden olabilir.

Kısa devre, kaçak akım, elektrik çarpması, arıza, duman veya yangın riskini azaltmak için kumandayı su veya başka sıvılarla yıkamayın.

Elektrik çarpması, arıza, duman veya yangın riskini azaltmak için, anahtarları/düğmeleri ıslak elle çalıştırmayın veya diğer elektrikli parçalara ıslak elle dokunmayın.

Üniteyi alkolle dezenfekte ederken odayı yeterli miktarda havalandırın. Ünite çevresindeki alkol buharları ünite açıldığında yangına veya patlamaya neden olabilir.

Yaralanma veya elektrik çarpma riskini azaltmak için, kumanda civarına kimyasal maddeleri püskürtmeden önce çalışmayı durdurun ve kumandayı örtün.

Yaralanma veya elektrik çarpma riskini azaltmak için temizlik, bakım veya kumandada yapılacak bir inceleme öncesinde çalışmayı durdurun ve elektrik beslemesini kapatın.

Herhangi bir anormallik (örn., yanık konusu) fark edilirse çalışmayı durdurun, güç anahtarını kapatın ve bayiinize danışın. Ürünün kullanılmaya devam etmesi elektrik çarpmasına, arızaya veya yangına neden olabilir.

Kumandaya rutubet ve toz girmemesi için gerekli tüm kapakları doğru şekilde monte edin. Toz birikmesi ve su, elektrik çarpması, duman veya yangına neden olabilir.

DİKKAT

Yangın veya patlama riskini azaltmak için, kumanda yakınında kolay tutuşur malzemeleri yerleştirmeyin veya alev alan spreyleri kullanmayın.

Kumandanın hasar görme riskini azaltmak için, kumanda üzerine doğrudan böcek ilacı veya diğer alev alıcı spreyler püskürtmeyin.

Çevre kirliliği riskini azaltmak için, uzaktan kumandanın uygun biçimde bertaraf edilmesi konusunda yetkili bir kuruma başvurun.

Elektrik çarpması veya arıza riskini azaltmak için, dokunmatik panele, anahtar veya düğmelere sivri uçlu veya keskin cisimlerle dokunmayın.

Yaralanma ve elektrik çarpma riskini azaltmak için, belirli parçaların keskin kenarları ile temastan kaçının.

Yaralanma riskini azaltmak için kumanda üzerinde çalışırken koruyucu ekipman giyin.

Kırık camların yaralanmalara neden olmasını önlemek için, cam parçalara aşırı güç uygulamayın.

Kumandanın taşınması veya onarılması ile ilgili önlemler

UYARI

Kumanda sadece yetkili bir kişi tarafından onarılmalı veya taşınmalıdır. Kumandayı demonte etmeyin veya üzerinde değişiklik yapmayın. Yanlış montaj veya onarım yaralanma, elektrik çarpması veya yangına neden olabilir.

DİKKAT

Kısa devre, elektrik çarpması, yangın veya arıza riskini azaltmak için devre kartına aletlerle veya elinizle dokunmayın ve devre kartı üzerinde toz birikmesine izin vermeyin.

Ek önlemler

Kumandanın hasar görmemesi için montaj, inceleme veya onarım işlemlerini uygun araçlarla yapın.

Bu kumanda, Mitsubishi Electric tarafından özellikle Bina Yönetim Sistemi ile kullanım için tasarlanmıştır. Bu kumandanın diğer sistemlerle veya başka amaçlarla kullanılması arızalara yol açabilir.

Fiziksel ya da zihinsel engelleri bulunan ve duyu kaybı yaşamış ya da bu konuda tecrübe ve bilgisi olmayan kişiler (çocuklar dahil), gözetim altında olmadıkları veya güvenliklerinden sorumlu bir kişi tarafından cihazın kullanımı ile ilgili eğitim almadıkları sürece bu cihazı kullanmamalıdır. Cihazla oynamadıklarından emin olmak için çocuklar gözetim altında tutulmalıdır.

Renk solmasını önlemek için benzin, tiner veya kimyasal maddelerle kumandayı temizlemeyin. Kumandayı temizlemek için, hafif deterjanlı suya batırılmış yumuşak bir bez kullanın, deterjanlı ıslak bezle silin ve kuru bir bezle kurulaştırın.

Kumandanın hasar görmemesini önlemek için statik elektriğe karşı koruma sağlayın.

Bu cihaz mağazalar, ışık sektörü veya çiftliklerde uzmanlar ya da eğitilmiş kullanıcılar tarafından veya normal kişiler tarafından ticari amaçlı olarak kullanılmak için tasarlanmıştır.

Güç kablosu hasar görmüşse, herhangi bir kazanın meydana gelmesini önlemek için üretici, yetkili servis acentesi veya benzeri yetkili kişiler tarafından değiştirilmelidir.

Kumanda bileşenleri

Kumanda arayüzü - Durum ekranı/Ana ekran

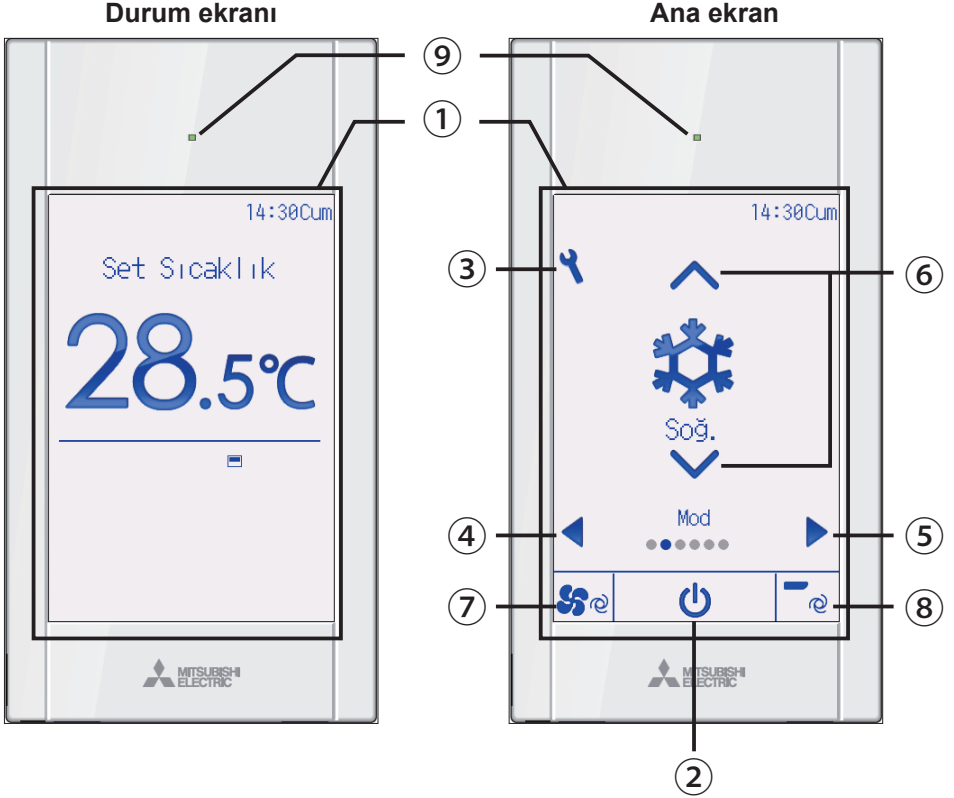

① Dokunmatik panel ve Arka ışıklı tam renkli LCD

Çalışma ayarları görüntülenir. Arka ışık kapalı iken herhangi bir alana basıldığında ekran Durum ekranına geçer. Durum ekranı görüntülendiğinde herhangi bir alana basılması ekranı Ana ekrana geri döndürür.

② AÇIK/KAPALI düğmesi

İç üniteyi AÇIK/KAPALI için basın.

③ Ayar düğmesi

Ana menüyü açmak için basın. Menü çalışması kilitlendiğinde yönetici parolası gereklidir.

④ ◀ düğmesi

Ayar öğelerini aşağıdaki sırada değiştirmek için basınız: iç kanat, havalandırma, kanat, fan hızı, çalışma modu ve ön ayar sıcaklığı.

⑤ ▶ düğmesi

Ayar öğelerini aşağıdaki sırada değiştirmek için basınız: ön ayar sıcaklığı, çalışma modu, fan hızı, kanat, havalandırma, ve iç kanat.

⑥ ▲ ▼ düğmesi

Yukarıdaki ④ ve ⑤ maddelerinde seçilen ayarların içeriklerini değiştirmek için basınız.

⑦ Fan hızı kısayol düğmesi

Doğrudan fan hızı ayarları ekranına ulaşmak için basınız.

⑧ Kanat kısayol düğmesi

Doğrudan kanat ayarları ekranına ulaşmak için basınız.

⑨ AÇIK/KAPALI lambası

“LED yanıyor” “Hayır” olarak ayarlanmamış ise, ünite çalışırken bu lamba yeşil renkte yanar. Uzaktan kumanda başlarken veya hata olduğunda lamba yanıp söner.

AÇIK/KAPALI çalışması kilitli iken, ② gösterilmez.

Ayar öğesi ④ veya ⑤ düğmesi ile değiştirildiğinde, seçili ayar öğesinin çalışması kilitli ise öğe gösterilmez.

Fan hızı veya kanat çalışması kilitli ise, ⑦ veya ⑧ öğesi gösterilmez.

Ayar öğesi sistem kontrol birimi üzerinden merkezi kontrollü iken ayar içerikleri ⑥ düğmesi ile değiştirilemez.

Kumanda bileşenleri

Kumanda arayüzü - Menü ekranı



① AÇIK/KAPALI düğmesi

İç üniteyi AÇIK/KAPALI için basın.

② SEÇİM düğmesi

Ayarı kaydetmek için basın.

③ GERİ düğmesi

Önceki ekrana dönmek için basın.
Ana menü görüntüleniyor iken düğmeye basıldığında Durum ekranı görüntülenir.

④ MENÜ düğmesi Sayfa 24

Ana menüyü açmak için basın.

⑤ İşlev düğmesi **F1**

Menü ekranı: Düğmenin işlevi ekrana göre değişir.

⑥ İşlev düğmesi **F2**

Ana menü: İmleci sola hareket ettirmek için basın.

Menü ekranı: Düğmenin işlevi ekrana göre değişir.

⑦ İşlev düğmesi **F3**

Ana menü: İmleci sağa hareket ettirmek için basın.

Menü ekranı: Düğmenin işlevi ekrana göre değişir.

⑧ İşlev düğmesi **F4**

Menü ekranı: Düğmenin işlevi ekrana göre değişir.

Düğmelerin işlevleri ekrana bağlı olarak değişiklik gösterir. Söz konusu ekranda hangi işlevi gerçekleştirdiklerini öğrenmek için LCD'nin altında görünen düğme işlev kılavuzuna bakın.

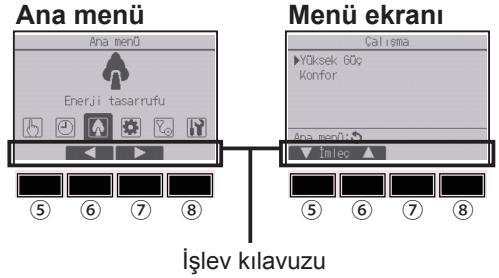

Kumanda bileşenleri

Ekran - Durum ekranı/Ana ekran

Durum ekranı ve Ana ekran iki farklı modda görüntülenebilir: “Dolu” ve “Temel.” Fabrika ayarı “Dolu” olarak yapılmıştır. Modun nasıl değiştirileceğini görmek için 58 sayfasına bakınız.

Dolu mod

* Tüm simgeler açıklama amacıyla görüntülenir.

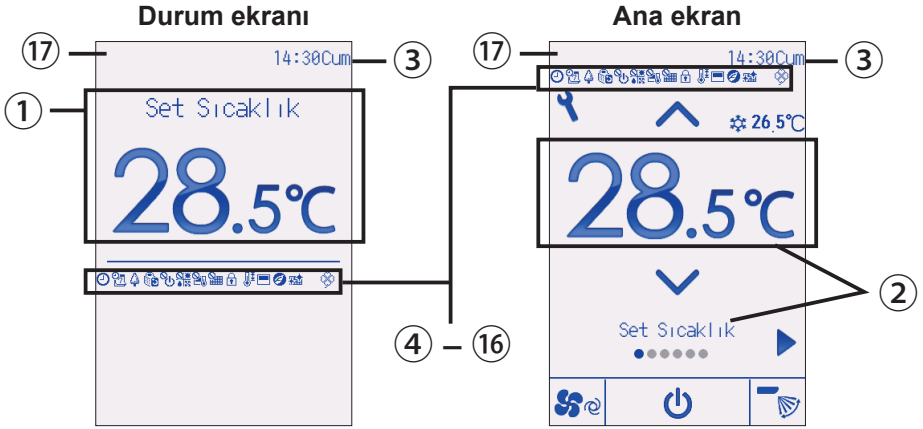

Temel mod

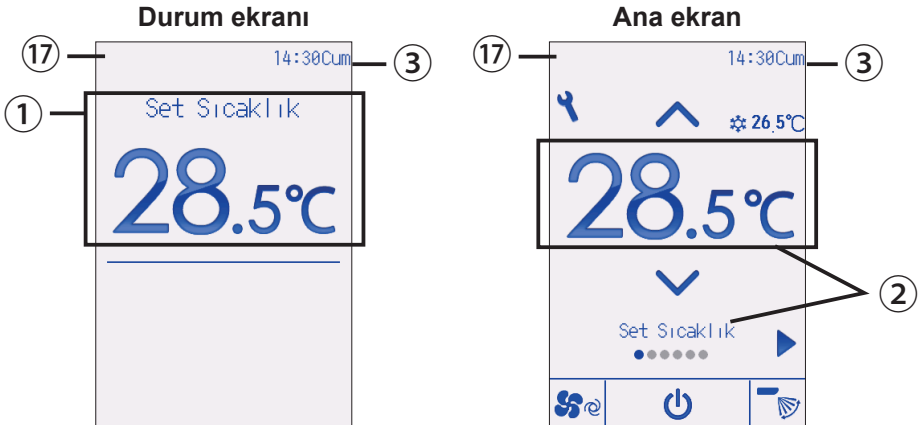

① Ön ayar sıcaklığı veya oda sıcaklığı

Ön ayar sıcaklığı veya oda sıcaklığı burada görünür.
(Montaj Kılavuzu'na bakın.)

② Ayar öğesi ve ayar içerikleri Sayfa 17

“Ön ayar sıcaklığı” ayar öğeleri ↔ “Çalışma modu” ↔ “Fan hızı” ↔ “Kanat” ↔ “Havalandırma” ↔ “İç Kanat,” ve bunların ayar içerikleri burada görünür. “Merkezi kontrollü” bir öğe çalıştırılırken belirli bir süre görüntülenir.

③ Saat

Geçerli zaman burada görünür.
(Montaj Kılavuzu'na bakın.)

④ Sayfa 29, 32, 40

Açma/Kapama zamanlayıcı (Sayfa 29), Gece ayarı (Sayfa 40) veya Otomatik kapatma zamanlayıcı (Sayfa 32) zamanlayıcı işlevi etkinleştirildiğinde görüntülenir.

 zamanlayıcı merkezi kontrol sistemi tarafından devre dışı bırakıldığında görüntülenir.

⑤ Sayfa 34

Haftalık zamanlayıcı etkinken görüntülenir.

⑥ Sayfa 51

Üniteler enerji tasarruf modunda çalışırken görüntülenir. (İç ünitelerin bazı modellerinde görüntülenmeyecektir)

⑦ Sayfa 37

Dış üniteler sessiz modda çalışırken görüntülenir.

⑧

AÇIK/KAPALI çalışması merkezi olarak kontrol edilirken görüntülenir.

⑨

Çalışma modu merkezi olarak kontrol edilirken görüntülenir.

⑩

Ön ayar sıcaklığı merkezi olarak kontrol edilirken görüntülenir.

⑪

Filtre sıfırlama işlevi merkezi olarak kontrol edilirken görüntülenir.

⑫ Sayfa 46

Düğmeler kilitliken görüntülenir.

⑬ Sayfa 43

Ön ayar sıcaklık aralığı kısıtlandığında görüntülenir.

⑭

Uzaktan kumandadaki dahili termistör oda sıcaklığını izlemek için etkinleştirildiğinde görüntülenir.

 İç ünitelerdeki termistör oda sıcaklığını izlemek için etkinleştirildiğinde görüntülenir.

⑮

“3D i-See sensor” işlevi kullanılarak bir enerji tasarrufu çalışması gerçekleştirildiğinde görülür.

⑯ Sayfa 78

Filtreye bakım gerektiğini gösterir.

⑰ Ön hata ekranı

Ön hata sırasında bir hata kodu görüntülenir.

Menü yapısı ve simgeler

Menü yapısı

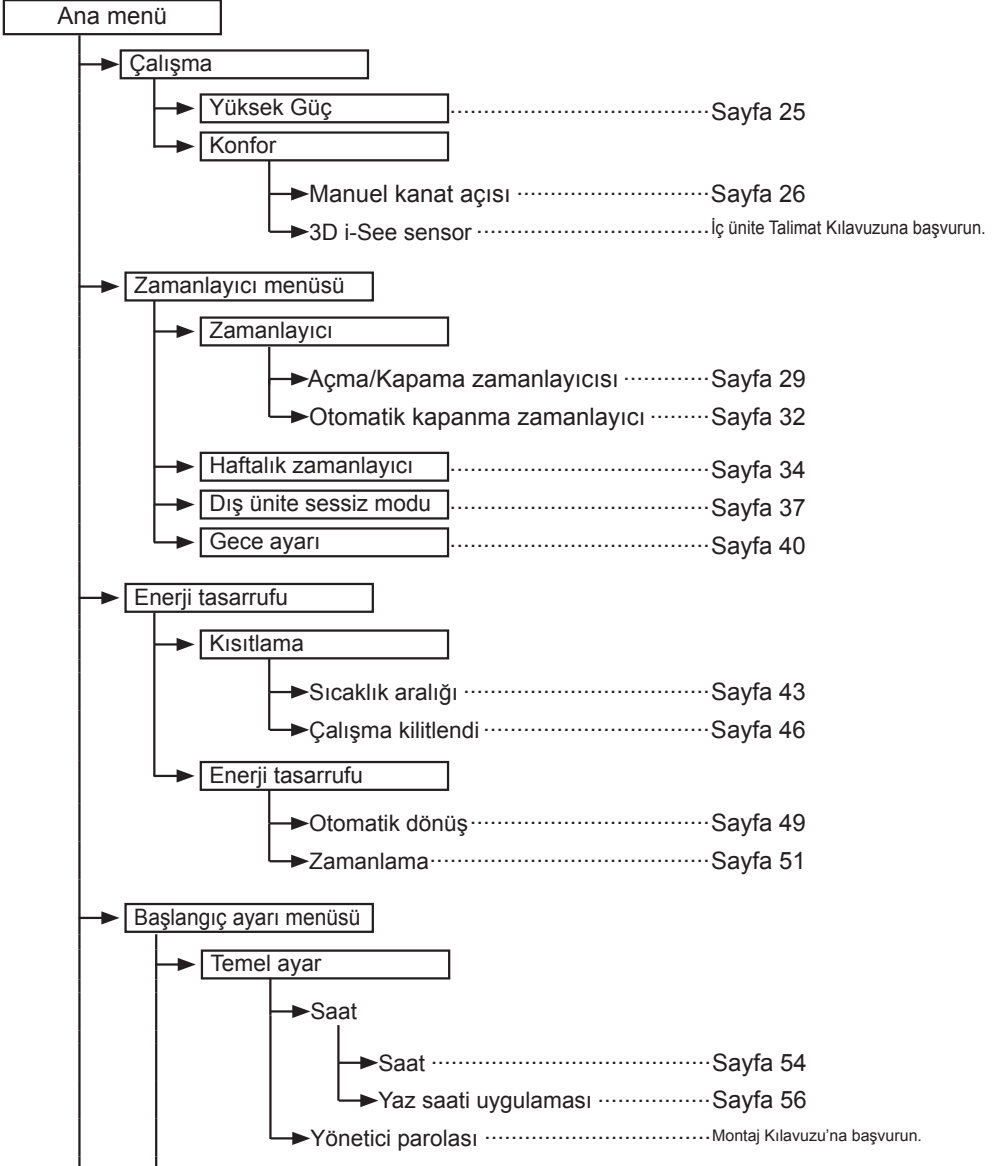

→	Ekran ayarı	
	→ Ana ekran	Sayfa 58
	→ Ekran ayrıntıları (Simge açıklamaları vs.)	Montaj Kılavuzu'na başvurun.
	→ Parlaklık	Sayfa 61
	→ Dil seçimi	Sayfa 62
	→ Tasarım	Sayfa 64
→	Çalışma ayarı	
	→ Otomatik modu	Montaj Kılavuzu'na başvurun.
→	Dokunmatik panel Sayfa 66
→	Bakım menüsü	
	→ Hata bilgisi	Sayfa 74
	→ Filtre bilgisi	Sayfa 78
	→ Temizleme	
	→ Otomatik alçalan panel	Otomatik yükselen panel ile birlikte gelen Montaj Kılavuzu'na başvurun.
	→ Alçalma işlemi	Otomatik yükselen panel ile birlikte gelen Montaj Kılavuzu'na başvurun.
	→ Alçalma ayarı	Otomatik yükselen panel ile birlikte gelen Montaj Kılavuzu'na başvurun.
→	Servis menüsü	
	→ Test çalıştırması menüsü	
	→ Test çalıştırması	İç ünite Montaj Kılavuzu'na bakın.
	→ Tahliye pompası test çalıştırması	İç ünite Montaj Kılavuzu'na bakın.
	→ Bakım bilgileri	İç ünite Montaj Kılavuzu'na bakın.
	→ Model adı girişi	İç ünite Montaj Kılavuzu'na bakın.
	→ Seri No. girişi	İç ünite Montaj Kılavuzu'na bakın.
	→ Satıcı bilgi girişi	İç ünite Montaj Kılavuzu'na bakın.
	→ Bakım bilgisi sıfırla	İç ünite Montaj Kılavuzu'na bakın.

Menü yapısı ve simgeler

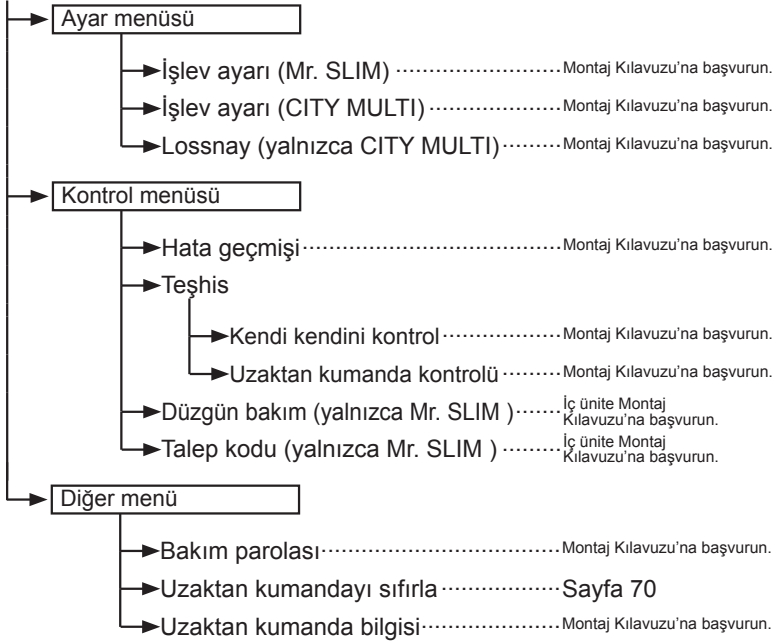

İç ünitelerin tüm modellerinde işlevlerin hepsi mevcut değildir.

Simgeler açıklamaları

Kumandanın çalışması

Zamanlayıcı



Aşağıdaki tabloda bu kılavuzda kullanılan kare simgeler özetlenmiştir.



Ayarları değiştirmek için şifre giriş ekranında yönetici veya bakım kullanıcı şifresi girilmelidir. Bu işlemi atlayabilecek hiçbir işlev yoktur.



- F1** : İmleci sola hareket ettirmek için basın.
- F2** : İmleci sağa hareket ettirmek için basın.
- F3** : Değeri 1 azaltmak için basın.
- F4** : Değeri 1 artırmak için basın.

* Doğru şifre girilmedikçe değişiklikler yapılamaz.



Yalnızca ünite çalıştırılırken değiştirilebilen ayarları gösterir.



Yalnızca ünite çalışmıyorken değiştirilebilen ayarları gösterir.



Üniteler yalnızca Soğutma, Isıtma veya Otomatik modda çalıştırılırken değiştirilebilen ayarları gösterir.



Düğmeler kilitliken veya merkezi olarak kontrol edilirken kullanılamayan işlevleri gösterir.

Temel işlemler

Güç AÇIK/KAPALI



Düğmenin çalışması

AÇIK



AÇIK/KAPALI düğmesine basın.

AÇIK/KAPALI lambası yeşil renkte yanar ve çalışma başlar.

“LED yanıyor” “Hayır” olarak ayarlanmış ise, AÇIK/KAPALI lambası yanmaz.

AÇIK/KAPALI düğmesi

KAPALI



AÇIK/KAPALI düğmesine tekrar basın.

AÇIK/KAPALI lambası söner ve çalışma durur.

Çalışma modu, sıcaklık, fan hızı, kanat, iç kanat, ve havalandırma (Lossnay) ayarları



Düğmenin çalışması

Çalışma modu



▼ veya ▲ düğmesine her basıldığında aşağıdaki çalışma modları arasında geçiş yapılır. İsteddiğiniz çalışma modunu seçin.



Soğutma



N.AI



Fan



Otomatik



Isıtma

- Bağlı iç ünite modelleri için mevcut olmayan çalışma modları ekranda görüntülenmez.

Yanıp sönen mod simgeleri ne anlama gelir?

Aynı soğutucu sistemindeki (aynı dış üniteye bağlı olan) diğer iç üniteler farklı bir modda zaten çalıştırıldığında mod simgesi yanıp sönecektir. Bu durumda, aynı gruptaki ünitelerin geri kalanı yalnızca aynı modda çalıştırılabilir.

<Otomatik (çift ayar noktası) mod>

Çalışma modu Otomatik (çift ayar noktası) moduna ayarlandığında, iki ön sıcaklık (biri ısıtma biri soğutma için) ayarlanabilir. Oda sıcaklığına bağlı olarak, iç ünite otomatik olarak Soğutma veya Isıtma modunda çalışır ve oda sıcaklığını önceden belirlenen aralıkta tutar.

Aşağıdaki grafik Otomatik (çift ayar noktası) modunda çalışan iç ünitenin çalışma desenini gösterir.

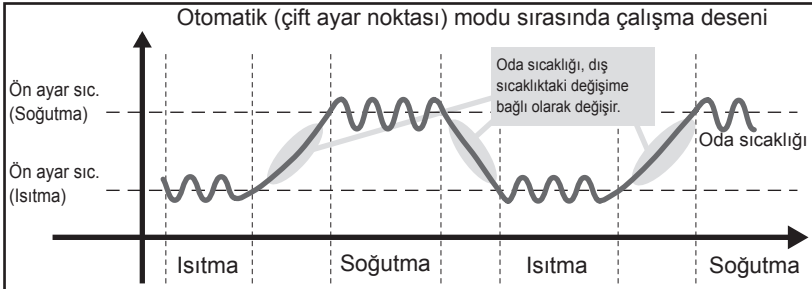

Temel işlemler

Ön ayar sıcaklığı

<Soğutma, Kurut., Isıtma, ve Otomatik (tek ayar noktası)>

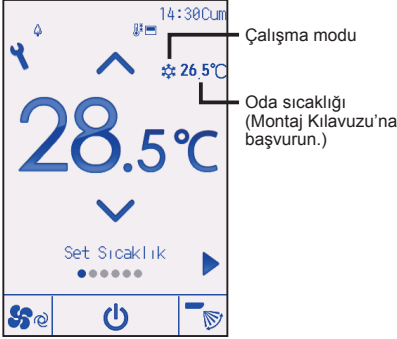

Ön ayar sıcaklığını azaltmak için ▼ düğmesine, artırmak için ▲ düğmesine basın.

- Farklı çalışma modlarının ayarlanabilir sıcaklık aralıklarını görmek için sayfa 19'teki tabloya bakın.
- Ön ayar sıcaklık aralığı Fan/Havalandırma çalışması için ayarlanamaz.
- Ön ayar sıcaklığı, iç ünitenin modeline ve uzaktan kumandadaki ekran modu ayarına bağlı olarak 0,5- veya 1-derecelik artışlarla Santigrat veya Fahrenheit olarak görüntülenir.

<Otomatik (çift ayar noktası) mod>

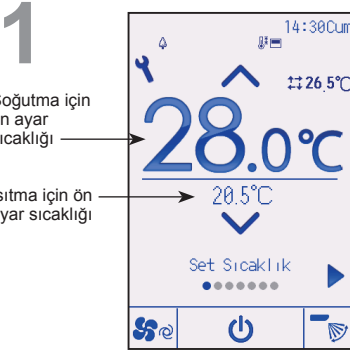

Geçerli ön ayar sıcaklıkları görüntülenir.

◀ veya ▶ düğmesine her basıldığında soğutma ve ısıtma için ön ayarlı sıcaklıklar arasında geçiş yapılır.

2

Soğutma için
ön ayar
sıcaklığı.

Isıtma için ön
ayar sıcaklığı.

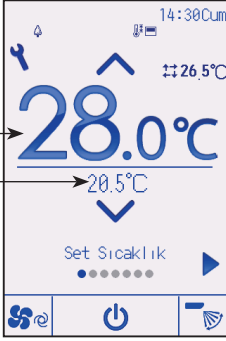

Seçili sıcaklığı azaltmak için ▼ düğmesine, artırmak için ▲ düğmesine basın.

- Farklı çalışma modlarının ayarlanabilir sıcaklık aralıklarını görmek için sayfa aşağıdaki tabloya bakın.
- Otomatik (çift ayar noktası) modundaki ısıtma ve soğutma için ön ayar sıcaklık ayarları Soğutma/Kurut. ve Isıtma modları tarafından da kullanılır.
- Otomatik (çift ayar noktası) modundaki ısıtma ve soğutma için ön ayar sıcaklıkları aşağıdaki koşulları sağlamalıdır:
 - Önceden ayarlanan soğutma sıcaklığı, önceden ayarlanan ısıtma sıcaklığından yüksektir.
 - Soğutma ve ısıtma ön ayar sıcaklıkları arasındaki minimum sıcaklık farkı gereksinimi (bağlı iç ünite modeline göre değişir) karşılanmaktadır.
 - Eğer ön ayar sıcaklıkları minimum sıcaklık farkı gereksinimini karşılamayacak şekilde ayarlanmışsa, iki ön ayar sıcaklığı da izin verilen ayar aralığında otomatik olarak değiştirilir.

Ayarlanabilir ön ayar sıcaklığı aralığı

Çalışma modu	Ön ayar sıcaklığı aralığı
Soğutma/Kurut.	19 ~ 30°C (67 ~ 87°F)
Isıtma	17 ~ 28°C (63 ~ 83°F)
Otomatik (Tek ayar noktası)	19 ~ 28°C (67 ~ 83°F)
Otomatik (Çift ayar noktası)	[Soğutma] Soğutma modu için ön ayarlı sıcaklık aralığı [Isıtma] Isıtma modu için ön ayarlı sıcaklık aralığı
Fan/Havalandırma	Ayarlanabilir değildir

Ayarlanabilir sıcaklık aralığı iç ünitelerin modları ile değişir.

Temel işlemler

Fan hızı



▼ veya ▲ düğmesine her basıldığında aşağıdaki fan hızları arasında geçiş yapılır.



• Kullanılabilen fan hızları bağlı iç ünitelerin modellerine bağlıdır.

Kanat ayarı



(CITY MULTI örnek ekranı)

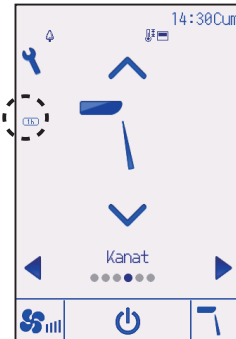

▼ veya ▲ düğmesine her basıldığında aşağıdaki kanat hızları arasında geçiş yapılır. İstedığınız ayarı seçin.

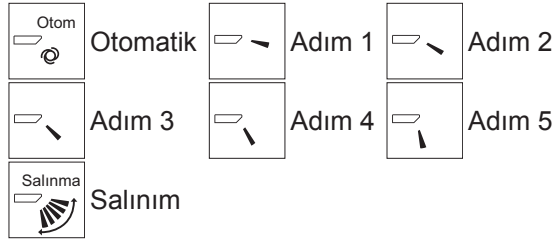

Kanatları otomatik olarak yukarı aşağı hareket ettirmek için “Salınım” seçeneğini belirleyin.

“Adım 1” ile “Adım 5” arasında ayarlandığında, kanat seçili açıda ayarlanacaktır.

• **1h** Kanat ayar simgesinin solunda Kanat Adım 2, 3, 4 veya 5'e ayarlanmışsa bu simge görüntülenir ve soğutma veya kurutma işlemi sırasında (modele bağlı olarak) fan düşük hızda çalışır.

Bu simge bir saat içinde kaybolur ve kanat ayarı otomatik olarak değişir.

İç kanat ayarı

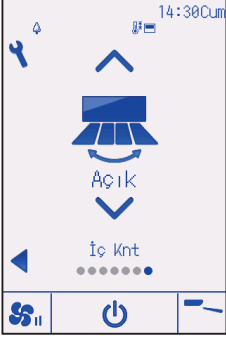

(CITY MULTI örnek ekranı)

İç kanat salınımını açmak veya kapamak için ▼ veya ▲ düğmesine basın.



Kapalı



Açık

Havalandırma ayarı

Havalandırma ayarı üniteler çalışırken dahi yapılabilir.

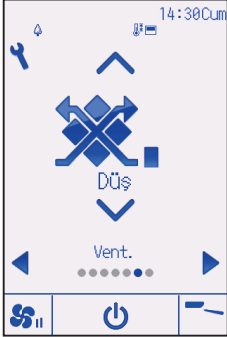

(Mr. SLIM örnek ekranı)

▼ veya ▲ düğmesine her basıldığında aşağıdaki havalandırma hızları arasında geçiş yapılır.

* Yalnızca Lossnay ünitesi bağlıyken ayarlanabilir.



Kapalı



Düşük



Yüksek

• Bazı iç ünite modellerinde bulunan fan, belli havalandırma üniteleri ile ara kilitlemeli olabilir.

Menüde gezinme

Ana menü listesi

Ana menü	Ayar öğeleri		Ayar ayrıntıları	Sayfa
Çalışma	Yüksek Güç		Rahat ettiğiniz oda sıcaklığına hızlı biçimde ulaşmak için kullanın. <ul style="list-style-type: none">• Üniteler Yüksek güç modunda en fazla 30 dakika çalıştırılabilir.	25
	Konfor	Manuel kanat açısı	Her bir kanat açısını ayarlamak için kullanın.	26
Zamanlayıcı	Zamanlayıcı	Açma/Kapama zamanlayıcı	Çalışma Açma/Kapama zamanlarını ayarlamak için kullanın. <ul style="list-style-type: none">• Zaman 5 dakikalık artışlarla ayarlanabilir.* Saat ayarı gereklidir.	29
		Otomatik kapanma zamanlayıcı	Otomatik kapatma zamanlayıcısını ayarlamak için kullanın. <ul style="list-style-type: none">• Zaman 10 dakikalık artışlarla 30 ile 240 arasındaki bir değere ayarlanabilir.	32
	Haftalık zamanlayıcı		Haftalık çalışma Açma/Kapama zamanlarını ayarlamak için kullanın. <ul style="list-style-type: none">• Her gün için sekize kadar çalışma deseni ayarlanabilir.• İki tür haftalık zamanlama türü ayarlanabilir.* Saat ayarı gereklidir.* Açma/Kapama zamanlayıcısı etkin olduğunda geçerli değildir.* 1°C'lik artışlar	34
	Dış ünite sessiz modu		Dış ünitelerin sessiz çalışmasının, sıcaklık kontrolüne göre daha öncelikli olduğu zaman aralıklarını ayarlamak için kullanın. Haftanın her günü için Başlatma/Durdurma zamanlarını ayarlayın. <ul style="list-style-type: none">• “Norma.”, “Orta”, ve “Sustur” seçenekleri arasında istediğiniz sessiz mod düzeyini seçin.* Saat ayarı gereklidir.	37
	Gece ayarı		Gece ayarlarını yapmak için kullanın. <ul style="list-style-type: none">• Ayarı etkinleştirmek için “Evet”i, devre dışı bırakmak için “Hayır”ı seçin. Sıcaklık aralığı ve başlatma/durdurma süreleri ayarlanabilir.* Saat ayarı gereklidir.* 1°C'lik artışlar	40
	Enerji tasarrufu	Kısıtlama	Sıcaklık aralığı	Ön ayar sıcaklık aralığını kısıtlamak için kullanın. <ul style="list-style-type: none">• Farklı çalışma modları için farklı sıcaklık aralıkları ayarlanabilir.* 1°C'lik artışlar
Çalışma kilitli			Seçili işlevleri kilitlemek için kullanın. <ul style="list-style-type: none">• Kilitli işlevler çalıştırılmaz.	46
Enerji tasarrufu		Otomatik dönüş	Belirli bir zaman aralığı için enerji tasarruflu çalıştırma yaptıktan sonra üniteleri ön ayar sıcaklığında çalıştırmak için kullanın. <ul style="list-style-type: none">• Zaman 10 dakikalık artışlarla 30 ile 120 arasındaki bir değere ayarlanabilir.* Ön ayar sıcaklık aralıkları kısıtlandığında bu işlev geçerli olmaz.* 1°C'lik artışlar	49

Ana menü	Ayar öğeleri		Ayar ayrıntıları	Sayfa
Enerji tasarrufu	Enerji tasarrufu	Zamanla	<p>Üniteleri haftanın her gününde enerji tasarruf modunda çalıştırmak ve enerji tasarruf aralığını ayarlamak için başlatma/durdurma sürelerini ayarlayın.</p> <ul style="list-style-type: none"> Her gün için en fazla dört farklı enerji tasarruflu çalışma deseni ayarlanabilir. Zaman 5 dakikalık artışlarla ayarlanabilir. Enerji tasarruf aralığı %0 ve 50'den %90'a %10'luk artışlarla ayarlanabilir. <p>* Saat ayarı gereklidir.</p>	51
Başlangıç ayarı	Temel ayar	Saat	Geçerli zamanı ayarlamak için kullanın.	54
		Yaz saati uygulaması	Yaz saati uygulamasını ayarlar.	56
	Ekran ayarı	Ana ekran	Durum ekranı ve Ana ekran için "Dolu" ve "Temel" modları arasında geçiş yapmak için kullanın.	58
		Parlaklık	Ekran parlaklığını ayarlamak için kullanın.	61
		Dil seçimi	İstedığınız dili seçmek için kullanın.	62
		Tasarım	Durum ekranı ve Ana ekran rengini değiştirmek için kullanın.	64
	Dokunmatik panel	Dokunmatik panel kalibrasyonu	Dokunmatik panelin kalibrasyon ayarlarını belirleyin.	66
		Dokunmatik panel temizleme	Temizleme amacıyla dokunmatik panelin dokunma algılamasını geçici olarak kapatır.	68
Servis	Uzaktan kumandayı sıfırla	Uzaktan kumandayı fabrika ayarlarına sıfırlamak için kullanın.	70	
	Uzaktan kumanda bilgisi	Uzaktan kumandanın model adı, yazılım versiyonu ve seri numarasını görüntülemek için kullanın.	72	
Bakım	Hata bilgisi	<p>Herhangi bir hata meydana geldiğinde hata bilgilerini kontrol etmek için kullanın.</p> <ul style="list-style-type: none"> Hata kodu, hatanın kaynağı, soğutucu adresi, ünite modeli, üretim numarası, iletişim bilgileri (satıcının telefon numarası) görüntülenebilir. <p>* Görüntülenebilmesi için ünite modeli, üretim numarası ve iletişim bilgilerinin önceden kaydedilmesi gerekir.</p>	74	
	Filtre bilgisi	<p>Filtre durumunu kontrol etmek için kullanın.</p> <ul style="list-style-type: none"> Filtre işareti sıfırlanabilir. 	78	

Menüde gezinme

Ana menüde gezinme

Düğmenin çalışması

Ana menüye erişme

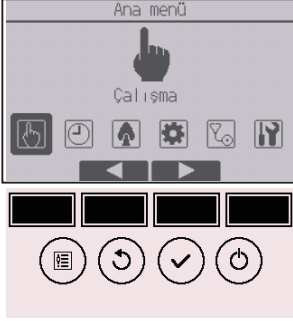

Ana ekranda **[Ayar]** düğmesine basın.

Ana menüye görüntülenecektir.

Öğe seçimi

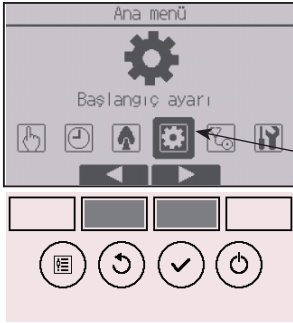

İmleci sola hareket ettirmek için **[F2]** düğmesine basın.
İmleci sağa hareket ettirmek için **[F3]** düğmesine basın.

İşlev ayarları

Yüksek Güç



İşlev açıklaması

Yüksek güçte çalıştırma işlevi ünitelerin normal kapasitenin üstünde çalışmasını sağlar. Böylece oda havası ideal sıcaklığa hızlıca ulaşacak biçimde koşullandırılabilir. Bu çalışma en fazla 30 dakika sürer ve ünite hangisi önce gerçekleşirse 30 dakikanın sonunda veya oda sıcaklığı ön ayar sıcaklığına ulaştığında normal çalışma moduna geri döner. Çalışma modu veya fan hızı değiştirildiğinde üniteler normal çalışmaya geri dönecektir.

Düğmenin çalışması

1



Soğutma, Isıtma veya Otomatik çalıştırma sırasında Çalışma menüsünde “Yüksek Güç” seçeneğini belirleyin ve **SEÇİM** düğmesine basın.

“Yüksek Güç” işlevi yalnızca bu işlevi destekleyen modellerde kullanılabilir.

2



İmleci **F3** veya **F4** düğmesi ile “Evet” ögesine getirin ve **SEÇİM** düğmesine basın.

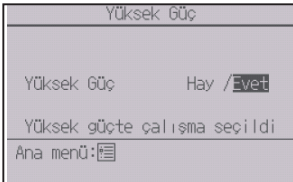

Bir onay ekranı görüntülenecektir.

Ekranlar arasında gezinme

- Ana menüye geri dönmek için **MENU** düğmesi
- Önceki ekrana geri dönmek için **GERİ** düğmesi

İşlev ayarları

Manuel kanat açısı

OFF

Düğmenin çalışması

1



Çalışma menüsünden "Konfor" seçeneğini seçin ve **SEÇİM** düğmesine basın.

2



"Manuel kanat açısı" öğesini **F1** veya **F2** düğmesi ile seçin ve **SEÇİM** düğmesine basın.

3



Seçmek için imleci [F1] düğmesi ile "Ref. adresi" veya "Ünite No." öğesine getirin.

Kanatları sabitlenecek üniteler için soğutucu adresini ve ünite numarasını [F2] veya [F3] düğmesiyle seçin ve [SEÇİM] düğmesine basın.

- Ref. adresi: Soğutucu adresi
- Ünite No.: 1, 2, 3, 4

Üniteyi onaylamak için [F4] düğmesine basın.

Soldaki ekranda Mr. SLIM için bir örnek ekran gösterilmektedir. CITY MULTI ünitelerinde "Ref. adresi" yerine "M-NET adresi" görüntülenir ve "Ünite No." görüntülenmez.

4



[F1] düğmesi ile "Kanat"ı seçin.

"4 yol." veya "2 yol." öğesini [F2] veya [F3] düğmesi ile seçin ve [F4] düğmesine basın.

İşlev ayarları

5

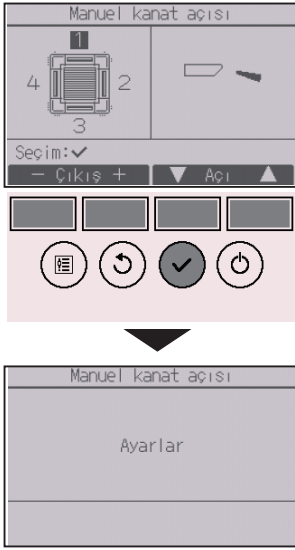

Geçerli kanat ayarı görüntülenir.

İstenen çıkışları "1," "2," "3," "4," veya "1, 2, 3, 4 (tümü)" şeklinde [F1] veya [F2] düğmesi ile seçin.

Aşağıdaki seçeneklerde gezinmek ve istenen ayarı seçmek için [F3] veya [F4] düğmesine basın.

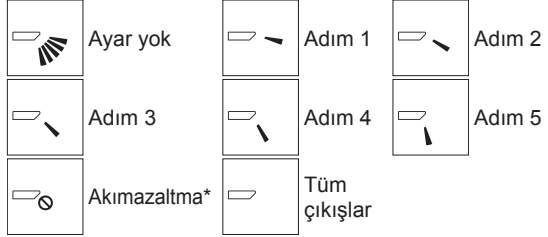

Ayarları kaydetmek için [SEÇİM] düğmesine basın. Ayar bilgilerinin iletilmekte olduğunu gösteren bir ekran görüntülenir.

Ayar değişiklikleri seçili üniteye uygulanacaktır. İletim tamamlandığında ekran otomatik olarak önceki ekrana döner.

Aynı prosedürleri izleyerek diğer çıkışlar için de ayarları yapın.

Tüm çıkışlar seçilirse, ünite bir sonraki sefer çalışmaya başladığında  görüntülenir.

Ekranslar arasında gezinme

• Önceki ekrana geri dönmek için [GERİ] düğmesi

*Akım azaltma

[Akım azaltma] modu, kanat açısını, hava akımının insanlara doğrultulmayacağı şekilde Adım 1 açısından daha yatayda tutar.

Bu işlem yalnızca bir çıkış için ayarlanabilir.

Bu işlem, iki veya üç çıkışlı modeller için ayarlanamaz.

Akım azaltma modunda, hava akımı tavanda renk bozulmasına neden olabilir.

Zamanlayıcı (Açma/Kapama zamanlayıcı)



Düğmenin çalışması

1



Ana menüden “Zamanlayıcı” seçeneğini seçin (bkz. sayfa 24) ve **SEÇİM** düğmesine basın.

Açma/Kapama zamanlayıcısı aşağıdaki durumlarda çalışmaz:

Açma/Kapama zamanlayıcısı devre dışı bırakıldığında, hata sırasında, kontrol sırasında (servis menüsünde), test çalıştırması sırasında, uzaktan kumanda sorun tespitinde, saat ayarlanmadığında, İşlev ayarı sırasında, sistem merkezi olarak kontrol edilirken (Yerel uzaktan kumandadan AÇIK/KAPALI çalışması, sıcaklık ayarı veya Zamanlayıcı işlemi kısıtlandığında).

2

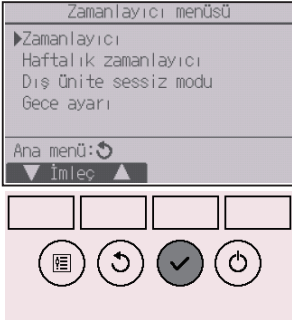

İmleci “Zamanlayıcı” seçeneğine getirin ve **SEÇİM** düğmesine basın.

3



Geçerli ayarlar görüntülenir.

İmleci “On/Off zaman.” seçeneğine getirin ve **SEÇİM** düğmesine basın.

İşlev ayarları

4



Zamanlayıcının ayarlanacağı ekran görüntülenecektir.

[F1] veya [F2] düğmesini kullanarak "On/Off zaman.," "Açık," "Kapalı," veya "Tekrar" seçeneklerinden birini seçin.

5



Ayarı [F3] veya [F4] düğmesi ile değiştirin.

- On/Off zaman.: Hayır (devre dışı)/Evet (etkin)
- Açık: Çalışma başlama saati
(5 dakikalık artışlarla ayarlanabilir)
* Sayıları hızlıca ilerletmek için düğmeyi basılı tutun.
- Kapalı: Çalışmayı durdurma saati
(5 dakikalık artışlarla ayarlanabilir)
* Sayıları hızlıca ilerletmek için düğmeyi basılı tutun.
- Tekrar: Hayır (bir kez)/Evet (tekrar)

6



Ayarları kaydetmek için **SEÇİM** düğmesine basın.





Bir onay ekranı görüntülenecektir.

Ekranlar arasında gezinme

- Ana menüye geri dönmek için **MENU** düğmesi
- Önceki ekrana geri dönmek için **GERİ** düğmesi



Açma/Kapama zamanlayıcısı etkinleştirildiğinde Durum ekranında  görüntülenir ve Dolu modda Ana ekranda görüntülenir.

Zamanlayıcı merkezi kontrol sistemi tarafından devre dışı bırakıldığında  görüntülenir.

İşlev ayarları

Zamanlayıcı (Otomatik kapanma zamanlayıcı)



Düğmenin çalışması

1



Zamanlayıcı ayarlama ekranını getirir.
(Bkz. sayfa 29.)

“Oto-Kapanma” seçeneğini seçin ve **SEÇİM** düğmesine basın.

Otomatik kapanma zamanlayıcı aşağıdaki durumlarda çalışmaz:

Otomatik kapanma zamanlayıcı devre dışı bırakıldığında, hata sırasında, kontrol sırasında (servis menüsünde), test çalıştırması sırasında, uzaktan kumanda sorun tespitinde, İşlev uyarı sırasında, sistem merkezi olarak kontrol edilirken (Yerel kumandadan AÇIK/KAPALI çalışması, sıcaklık uyarı veya Zamanlayıcı işlemi kısıtlandığında).

2



Geçerli ayarlar görüntülenir.

F1 veya **F2** düğmesini kullanarak imleci “Oto-Kapanma” veya “--- dak içinde dur” üzerine getirin.

3

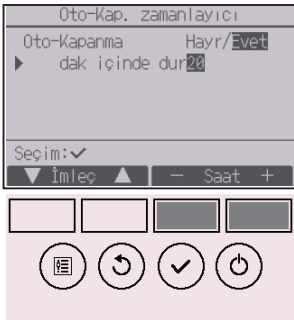

Ayarı **F3** veya **F4** düğmesi ile değiştirin.

- Oto-Kapanma: Hayır (devre dışı)/Evet (etkin)
- --- dak içinde dur: Zamanlayıcı uyarı (Ayarlanabilir aralık 10 dakikalık artışlarla 30 ile 240 dakika arasındadır.)

4



Ayarları kaydetmek için **SEÇİM** düğmesine basın.

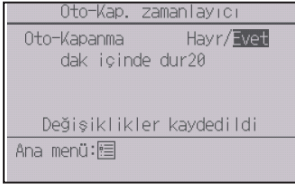



Bir onay ekranı görüntülenecektir.

Ekranlar arasında gezinme

- Ana menüye geri dönmek için **MENÜ** düğmesi
- Önceki ekrana geri dönmek için **GERİ** düğmesi



Otomatik kapanma zamanlayıcı etkinleştirildiğinde Durum ekranında  görüntülenir ve Dolu modda Ana ekranda görüntülenir.

Zamanlayıcı merkezi kontrol sistemi tarafından devre dışı bırakıldığında  görüntülenir.

İşlev ayarları

Haftalık zamanlayıcı



Düğmenin çalışması

1



Zamanlayıcı menüsünden “Haftalık zamanlayıcı” seçeneğini seçin ve **SEÇİM** düğmesine basın.

Haftalık zamanlayıcı aşağıdaki durumlarda çalışmaz:

Açma/Kapama zamanlayıcısı etkinleştirildiğinde, haftalık zamanlayıcı devre dışı bırakıldığında, hata sırasında, kontrol sırasında (servis menüsünde), test çalıştırması sırasında, uzaktan kumanda sorun tespitinde, saat ayarlanmadığında, işlev ayarı sırasında, sistem merkezi olarak kontrol edilirken (Yerel uzaktan kumandadan AÇIK/KAPALI çalışması, sıcaklık ayarı veya zamanlayıcı işlemi kısıtlandığında).

2



Geçerli ayarlar görüntülenir.

Haftanın her gününün ayarlarını görmek için **F1** veya **F2** düğmesine basın.

5 ile 8 arasındaki desenleri görmek için **F3** düğmesine basın.

Ayar 2 durumunu görüntülemek için **F4** düğmesine basın.

Ayar ekranına gitmek için **SEÇİM** düğmesine basın.

3



Haftalık zamanlayıcı ayarları ekranı görüntülenir.

“Eylem” ayarında, **[F3]** veya **[F4]** düğmesi ile zamanlayıcı ayarı 1’i etkinleştirmek için “1”i veya zamanlayıcı ayarı 2’yi etkinleştirmek için “2”yi seçin. Ardından **[SEÇİM]** düğmesine basın.

Zamanlayıcı ayarı 1 veya 2’nin ayar içeriklerini kontrol etmek için, imleci **[F1]** veya **[F2]** düğmesi ile “Ayar” üzerine getirin ve **[F3]** veya **[F4]** düğmesi ile “1” veya “2”yi seçin.

4



Haftalık zamanlayıcı ekranı görünür ve geçerli ayarlar görüntülenir.

Her gün için sekize kadar çalışma deseni ayarlanabilir.

İmleci **[F1]** veya **[F2]** düğmesi ile haftanın istediğiniz gününe getirin ve günü seçmek için **[F3]** düğmesine basın. (Birden fazla gün seçilebilir.)

[SEÇİM] düğmesine basın.

İşlev ayarları

5

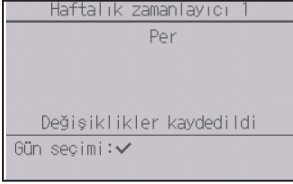

Çalışma deseni ayarlama ekranı görüntülenir. İmleci istediğiniz desen numarasına hareket ettirmek için [F1] düğmesine basın. İmleci [F2] düğmesiyle Süre, Açık/Kapa veya Sıcaklık seçeneğine getirin.

Ayarları [F3] veya [F4] düğmesi ile değiştirin.

- Zaman: 5 dakikalık artışlarla ayarlanabilir
- * Sayıları hızlıca ilerletmek için düğmeyi basılı tutun.
- Açık/Kapalı/Otom.: Seçilebilen ayarlar bağlı olan iç ünitenin modeline bağlıdır. (Bir Otomatik deseni uygulandığında, sistem Otomatik (çift ayar noktası) modunda çalışır.)
- Sıcaklık: Ayarlanabilir sıcaklık aralığı, bağlı iç ünitelere göre farklılık gösterir. (1°C'lik artışlar) Otomatik (çift ayar noktası) modu seçildiğinde, iki ön ayar sıcaklığı ayarlanabilir. Otomatik (çift ayar noktası) modunda tek ön ayar sıcaklığı ayarıyla bir çalışma deseni uygulanırsa, Soğutma modunda o ayar soğutma sıcaklığı ayarı olarak kullanılır.

Ayarları kaydetmek için [SEÇİM] düğmesine basın. Bir onay ekranı görüntülenecektir.

Ekranlar arasında gezinme

- Ayar değiştirme/haftanın gününü değiştirme ekranına geri dönmek için [SEÇİM] düğmesi
- Ana menüye geri dönmek için [MENÜ] düğmesi
- Önceki ekrana geri dönmek için [GERİ] düğmesi



Geçerli gün için haftalık zamanlayıcı ayarı yapılmışsa, Durum ekranında  görüntülenir ve Dolu modda Ana ekranda görüntülenir.

Açma/Kapama zamanlayıcısı etkinse veya sistem merkezi kontrol altındayken simge görüntülenmeyecektir (yerel uzaktan kumandadan "Zamanlayıcı" işlemi kısıtlandığında).

İşlev açıklaması

Bu işlev, kullanıcının dış ünitelerin sessiz çalışmasının, sıcaklık kontrolüne göre daha öncelikli olduğu zaman aralıklarını ayarlamasını sağlar. Sessiz çalışma için başlama ve durma zamanlarını haftanın her günü için ayarlayın. "Orta" ve "Sustur" seçenekleri arasından istediğiniz sessiz mod seviyesini seçin.

Düğmenin çalışması

1



Zamanlayıcı menüsünden "Dış ünite sessiz modu" seçeneğini seçin ve **SEÇİM** düğmesine basın.

"Dış ünite sessiz modu" işlevi yalnızca bu işlevi destekleyen modellerde kullanılabilir.

2



Geçerli ayarlar görüntülenir.

Haftanın her gününün ayarlarını görmek için **F1** veya **F2** düğmesine basın.

Ayar ekranına gitmek için **SEÇİM** düğmesine basın.

İşlev ayarları

3



Sessiz modun etkinleştirileceği (Evet) ve devre dışı bırakılacağı (Hayır) ekran görüntülenecektir.

Bu ayarı etkinleştirmek için imleci **F3** veya **F4** düğmesiyle "Evet" ögesine getirin ve **SEÇİM** düğmesine basın.

4



Dış ünite sessiz modu ayarlama ekranı görüntülenir.

Ayarlama yapmak veya ayarı değiştirmek için, imleci **F1** veya **F2** düğmesi ile haftanın istediğiniz gününe getirin ve günü seçmek için **F3** düğmesine basın. (Birden fazla gün seçilebilir.)

SEÇİM düğmesine basın.

5

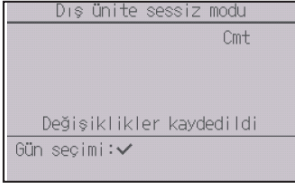

Ayarlama ekranı görüntülenir.

İmleci [F1] veya [F2] düğmesiyle Başlatma saati, Durdurma zamanı veya Sessiz mod düzeyi öğelerinden istediğinize getirin.

Ayarları [F3] veya [F4] düğmesi ile değiştirin.

- Başlatma/Durdurma Zamanı: 5 dakikalık artışlarla ayarlanabilir
* Sayıları hızlıca ilerletmek için düğmeyi basılı tutun.
- Sessiz mod seviyesi: Normal, Orta, Sustur



Normal



Orta



Sessiz

Ayarları kaydetmek için [SEÇİM] düğmesine basın. Bir onay ekranı görüntülenecektir.

Ekranlar arasında gezinme

- Ayar değiştirme/haftanın gününü değiştirme ekranına geri dönmek için [SEÇİM] düğmesi
- Ana menüye geri dönmek için [MENU] düğmesi
- Önceki ekrana geri dönmek için [GERİ] düğmesi



Dış ünite sessiz modu sırasında Durum ekranında  görüntülenir ve Dolu modda Ana ekranda görüntülenir.

İşlev ayarları

Gece ayarı



İşlev açıklaması

Bu kumanda, kumanda nesnesi grubu durdurulduğunda ve oda sıcaklığı ön ayar alt sınır sıcaklığının altına düştüğünde ısıtma işlemini başlatır. Ayrıca, Bu kumanda, kumanda nesnesi grubu durdurulduğunda ve oda sıcaklığı ön ayar üst sınır sıcaklığının üstüne çıktığında soğutma işlemini başlatır.

Gece ayarı işlevi çalışma ve sıcaklık ayarı uzaktan kumandadan yapıldığında kullanılamaz.

Oda sıcaklığı klimanın emilen sıcaklık sensörü tarafından ölçülüyorsa, klima devre dışıyken veya hava temiz değilken doğru sıcaklık elde edilemeyebilir. Bu durumda, sensörü bir uzak sensöre (PAC-SE40TSA/PAC-SE41TS-E) veya uzaktan kumanda sensörüne getirin.

Düğmenin çalışması

1



Zamanlayıcı menüsünden “Gece ayarı” seçeneğini seçin ve **SEÇİM** düğmesine basın.

2



Geçerli ayarlar görüntülenir.

Ayar ekranına gitmek için **SEÇİM** düğmesine basın.

3



İmleci [F1] veya [F2] düğmesiyle Gece ayarı Hayır (devre dışı)/Evet (etkin), Sıcaklık aralığı, Başlatma saati veya Durdurma zamanı seçeneklerinden istediğinize getirin.

Ayarları [F3] veya [F4] düğmesi ile değiştirin.

- Sıc.aralığı: Alt sınır sıcaklığı (ısıtma işlemi için) ve üst sınır sıcaklığı (soğutma işlemi için) ayarlanabilir. Alt ve üst sınırlar arasındaki sıcaklık farkı 4°C (8°F) veya üzerinde olmalıdır. Ayarlanabilir sıcaklık aralığı, bağlı iç ünitelere göre değişiklik gösterir.

* 1°C'lik artışlar

- Başlatma/Durdurma: 5 dakikalık artışlarla ayarlanabilir
- * Sayıları hızlıca ilerletmek için düğmeyi basılı tutun.



Ayarları kaydetmek için [SEÇİM] düğmesine basın. Bir onay ekranı görüntülenecektir.

Ekranlar arasında gezinme

- Ana menüye geri dönmek için [MENÜ] düğmesi
- Önceki ekrana geri dönmek için [GERİ] düğmesi

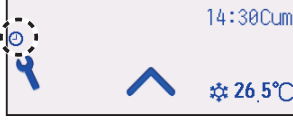
İşlev ayarları



Gece ayarı işlevi etkinleştirildiğinde Durum ekranında  görüntülenir ve Dolu modda Ana ekranda  görüntülenir.

Zamanlayıcı merkezi kontrol sistemi tarafından devre dışı bırakıldığında  görüntülenir.

Gece ayarı aşağıdaki durumlarda çalışmaz:

ünite çalışırken, Gece ayarı devre dışı bırakıldığında, hata sırasında, kontrol sırasında (servis menüsünde), test çalıştırması sırasında, uzaktan kumanda sorun tespitinde, saat ayarlanmadığında, işlev ayarı sırasında, sistem merkezi olarak kontrol edilirken (Yerel uzaktan kumandadan AÇIK/KAPALI çalışması, sıcaklık ayarı veya zamanlayıcı işlemi kısıtlandığında).

Sıcaklık aralığı kısıtlamasını ayarlama

Düğmenin çalışması

1

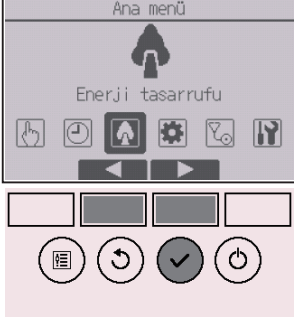

Ana menüde “Enerji tasarrufu” seçeneğini belirleyin (bkz. sayfa 24) ve **SEÇİM** düğmesine basın.

2



İmleci **F1** veya **F2** düğmesi ile “Kısıtlama” öğesine getirin ve **SEÇİM** düğmesine basın.

İşlev ayarları

3



Geçerli ayarlar görüntülenir.

İmleci [F1] veya [F2] düğmesi ile “Sıc.aralığı” ögesine getirin ve [SEÇİM] düğmesine basın.

4



Sıcaklık aralığının ayarlanacağı ekran görüntülenecektir.

İmleci [F1] düğmesi ile “Sıc.aralığı,” “Soğuk. •Kuru,” “Isıtma,” veya “Otom.” seçeneklerinden istediğinize getirin.

5

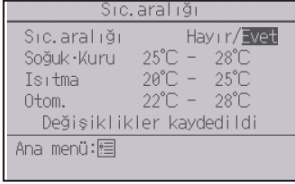

Ayarları [F3] veya [F4] düğmesi ile değiştirin.

- Sıc.aralığı: Hayır (kısıtlama yok) veya Evet (kısıtlı)
- Soğuk-Kuru: Üst ve alt sınır sıcaklığı (1°C'lik artışlar)
- Isıtma: Üst ve alt sınır sıcaklığı (1°C'lik artışlar)
- Otom.: Üst ve alt sınır sıcaklığı (1°C'lik artışlar)

Sıcaklık aralığı aralıkları

Mod	Alt sınır	Üst sınır
Soğuk-Kurutma *1	19 ~ 30°C (67 ~ 87°F)	30 ~ 19°C (87 ~ 67°F)
Isıtma *2	17 ~ 28°C (63 ~ 83°F)	28 ~ 17°C (83 ~ 63°F)
Otomatik *4	19 ~ 28°C (67 ~ 83°F)	28 ~ 19°C (83 ~ 67°F)

* Ayarlanabilir aralık, bağlı üniteye göre değişiklik gösterir.

*1 Soğutma, Kurut. ve Otomatik (çift ayar noktası) modları için sıcaklık aralıkları ayarlanabilir.

*2 Isıtma ve Otomatik (çift ayar noktası) modları için sıcaklık aralıkları ayarlanabilir.

*3 Isıtma, Soğutma ve Kurut. modları için sıcaklık aralıkları aşağıdaki koşulları sağlamalıdır:

- Soğutma için üst limit - ısıtma için üst limit \geq Minimum sıcaklık farkı (iç ünite modeline göre değişir)
- Soğutma için alt limit - ısıtma için alt limit \geq Minimum sıcaklık farkı (iç ünite modeline göre değişir)

*4 "Otomatik" (tek ayar noktası) modu için sıcaklık aralığı ayarlanabilir.

Ayarları kaydetmek için [SEÇİM] düğmesine basın. Bir onay ekranı görüntülenecektir.

Ekranlar arasında gezinme

- Ana menüye geri dönmek için [MENU] düğmesi
- Önceki ekrana geri dönmek için [GERİ] düğmesi

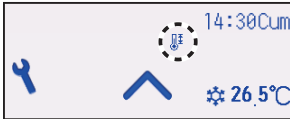

Sıcaklık aralığı kısıtlı iken Durum ekranında  görüntülenir ve Dolu modda Ana ekranda görüntülenir.

İşlev ayarları

Kısıtlama

P

Çalışma kilidi işlevi

Düğmenin çalışması

Çalışma kilidi işlevini etkinleştirmek için, "Çalışma kilittendi" seçeneğini "Evet" olarak ayarlayın.

1



Kısıtlama ayarlama ekranını getirir.
(Bkz. sayfa 43.)

İmleci "Çalışma kilittendi" seçeneğine getirin ve **SEÇİM** düğmesine basın.

2



Çalışma kilidi işlevinin ayarlarının yapılacağı ekran görüntülenir.

İmleci [F1] veya [F2] düğmesiyle “Çalışma kilitlendi”, “Konum” “On/Off”, “Mod”, “Set Sıcaklık”, “Menü”, “Fan”, “İç Knt” ya da “Kanat” seçeneklerinden istediğinize getirin.

Ayarları [F3] veya [F4] düğmesi ile değiştirin.

- Çalışma kilitle: Hayır (devre dışı)/Evet (etkin)
- Konum: “Ferd” veya “Otel”
- On/Off: AÇIK/KAPALI çalışması
- Mod: Çalışma modu ayarı
- Set Sıcaklık: Ön ayar sıcaklığı ayarı
- Kanat: Kanat ayarı
- Menü: Menü ayarı
- Fan: Fan hızı ayarı
- İç Knt: İç kanat ayarı

“-” / “Kilitli”

“Konum” ayarı için “Otel” seçildiğinde, aşağıdaki çalışma şekilleri otomatik olarak kilitlenir: Mod, Kanat, Menü, ve İç Kanat.

Ayarları kaydetmek için [SEÇİM] düğmesine basın. Bir onay ekranı görüntülenecektir.

Ekranlar arasında gezinme

- Ana menüye geri dönmek için [MENÜ] düğmesi
- Önceki ekrana geri dönmek için [GERİ] düğmesi

İşlev ayarları



Çalışma kilidi işlevi ayarı etkinleştirildiğinde Durum ekranında  görüntülenir ve Dolu modda Ana ekranda görüntülenir.

Kilitli işlevle ilgili çalışma kılavuzu gizlenir.

Menü ayarı kilitlenirken ana menüyü görüntülemek için, düğmesini on saniye veya daha uzun süreyle basılı tutun. Parola giriş ekranında yönetici parolasını girin.

Ön ayar sıcaklığına otomatik olarak dönme

Otomatik dönüş işlevi etkinleştirildikten sonra, bu uzaktan kumandadan çalışma modunu değiştirme veya AÇIK/KAPALI çalışması gerçekleştirildiğinde, ayarlı sıcaklık, ayarlı zamana bakılmaksızın otomatik olarak gereken sıcaklığa döner.

Düğmenin çalışması

1



Enerji tasarrufu menüsünden “Enerji tasarrufu” seçeneğini seçin ve **[SEÇİM]** düğmesine basın.

2



Geçerli ayarlar görüntülenir.

İmleci **[F1]** veya **[F2]** düğmesi ile “Otomatik dönüş” öğesine getirin ve **[SEÇİM]** düğmesine basın.

İşlev ayarları

3



Ön ayar sıcaklığına otomatik dönüş ayarlarının yapılacağı ekran görüntülenir.

İmleci [F1] veya [F2] düğmesiyle “Otomatik dönüş”, “Soğuk” veya “Sıcak” seçeneklerinden istediğinize getirin.

4



Ayarları [F3] veya [F4] düğmesi ile değiştirin.

- Otomatik dönüş: Hayır (devre dışı)/Evet (etkin)
- Soğuk: Zamanlayıcı ayarı aralığı, 10 dakikalık artışlarla 30 ile 120 dakika arasındadır.
Sıcaklık ayarı aralığı 19 ile 30°C arasındadır (67 ila 87°F) (1°C'lik artışlar).
- Sıcak: Zamanlayıcı ayarı aralığı, 10 dakikalık artışlarla 30 ile 120 dakika arasındadır.
Sıcaklık ayarı aralığı 17 ile 28°C arasındadır (63 ila 83°F) (1°C'lik artışlar).

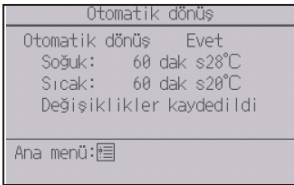

Ayarları kaydetmek için [SEÇİM] düğmesine basın. “Soğutma” işlemi “N.AI” ve “Oto Soğuk” modlarını, “Sıcak” işlemi ise “Oto Sıcak” modunu içerir. Seçilen öğenin ekranı görüntülenecektir.

Ekranlar arasında gezinme

- Ana menüye geri dönmek için [MENÜ] düğmesi
- Önceki ekrana geri dönmek için [GERİ] düğmesi

Sıcaklık aralığı kısıtlandığında ve sistem merkezi olarak kontrol edildiğinde (Sıcaklık aralığı ayarı yerel kumandadan kısıtlandığında) Zamanlayıcı veya Ön ayar sıcaklık ayarları etkin olmaz. Sistem merkezi olarak kontrol edildiğinde (zamanlayıcı işlemi yerel uzaktan kumandadan kısıtlandığında), sadece zamanlayıcı ayarı etkisiz olur.

Enerji tasarruflu çalışma programını ayarlama

Düğmenin çalışması

1



“Enerji tasarrufu” ekranını getirir. (Bkz. sayfa 49.)

İmleci “Zamanla” seçeneğine getirir ve **SEÇİM** düğmesine basın.

2



Söz konusu programın görüleceği ekran görüntülenir.

Haftanın her gününün ayarlarını görmek için **F1** veya **F2** düğmesine basın.

Ayar ekranına gitmek için **SEÇİM** düğmesine basın.

3



Enerji tasarruflu çalıştırma programının etkinleştirileceği “Evet” ve devre dışı bırakılacağı “Hayır” ekranı görüntülenecektir.

F3 veya **F4** düğmesi ile “Hayır” veya “Evet” seçeneğini belirleyin.

Ayar değiştirme/haftanın gününü değiştirme ekranına gitmek için **SEÇİM** düğmesine basın.

İşlev ayarları

4



Ayar değiştirme/haftanın gününü değiştirme ekranı görüntülenir.

Her gün için dörde kadar çalışma deseni ayarlanabilir.

İmleci [F1] veya [F2] düğmesi ile haftanın istediğiniz gününe getirin ve günü seçmek için [F3] düğmesine basın. (Birden fazla gün seçilebilir.)

Desen ayar ekranına gitmek için [SEÇİM] düğmesine basın.

5



Desen ayarlama ekranı görüntülenir.

İmleci istediğiniz desen numarasına hareket ettirmek için [F1] düğmesine basın.

İmleci [F2] düğmesi ile, başlatma saati, durdurma zamanı ve enerji tasarruf aralığı (soldan sağa bu sırada düzenlenmiştir) öğelerinden istediğinize getirin.

Ayarları [F3] veya [F4] düğmesi ile değiştirin.

- Başlatma/Durdurma Zamanı: 5 dakikalık artışlarla ayarlanabilir
- * Sayıları hızlıca ilerletmek için düğmeyi basılı tutun.
- Enerji tasarruf oranı: Ayar aralığı %0 ve 50 ile %90 arasındadır ve %10'luk artışlarla artırılabilir.

Ayarları kaydetmek için [SEÇİM] düğmesine basın. Bir onay ekranı görüntülenecektir.

Değer düşürüldükçe enerji tasarruf verimi de artar.

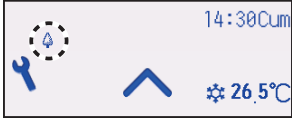

Ünite enerji tasarruf modunda çalıştırıldığında Durum ekranında  görüntülenir ve Dolu modda Ana ekranda görüntülenir.

Ekranlar arasında gezinme

- Ayar değiştirme/haftanın gününü değiştirme ekranına geri dönmek için **[SEÇİM]** düğmesi
- Ana menüye geri dönmek için **[MENÜ]** düğmesi
- Önceki ekrana geri dönmek için **[GERİ]** düğmesi

İşlev ayarları

Saat

P

Düğmenin çalışması

1

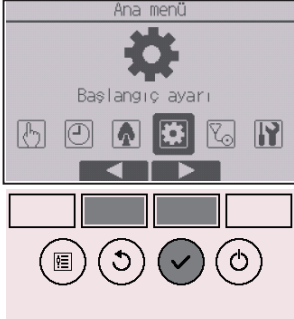

Ana menüde “Başlangıç ayarı” seçeneğini belirleyin (bkz. sayfa 24) ve **SEÇİM** düğmesine basın.

Şu ayarları yapmadan önce saat ayarı gereklidir.

- Açma/Kapama zamanlayıcı
- Haftalık zamanlayıcı
- Dış ünite sessiz modu
- Enerji tasarrufu
- Gece ayarı

Belirli bir sistemde sistem kontrol birimleri yoksa, saat zamanı otomatik olarak düzeltilmez.
Bu durumda, saat zamanı belirli aralıklarla düzeltilir.

2



İmleci **F1** veya **F2** düğmesi ile “Temel ayar” öğesine getirin ve **SEÇİM** düğmesine basın.

3



“Saat” öğesini **F1** veya **F2** düğmesi ile seçin ve **SEÇİM** düğmesine basın.

4



İmleci **F1** veya **F2** düğmesi ile “Saat” öğesine getirin ve **SEÇİM** düğmesine basın.

5



İmleci **F1** veya **F2** düğmesiyle yıl, ay, tarih, saat, dakika öğelerinden istediğimize getirin.

Seçilen öğenin değerini **F3** veya **F4** düğmesiyle artırın veya azaltın ve **SEÇİM** düğmesine basın. Bir onay ekranı görüntülenecektir.

Ekranlar arasında gezinme

- Ana menüye geri dönmek için **MENU** düğmesi
- Önceki ekrana geri dönmek için **GERİ** düğmesi

İşlev ayarları

Yaz saati uygulaması

P

İşlev açıklaması

Yaz saati uygulamasının başlama/bitiş saati ayarlanabilir. Yaz saati uygulaması işlevi ayar içeriğine bağlı olarak etkinleştirilir.

- Belirli bir sistemde sistem kontrol birimi varsa doğru saati korumak için bu ayarı devre dışı bırakın.
- Yaz saati uygulamasının başında ve sonunda zamanlayıcı devreye iki kez girebilir ya da hiç girmez.
- Saat ayarı yapılmadıkça bu işlev çalışmaz.

Düğmenin çalışması

1



Temel ayar menüsünden “Saat” seçeneğini seçin ve **SEÇİM** düğmesine basın.

2



İmleci **F1** veya **F2** düğmesi ile “Yaz saati uygulaması” öğesine getirin ve **SEÇİM** düğmesine basın.

3



Ayarları yapmak için imleci **[F1]** düğmesiyle aşağıdaki öğelere getirin.

- Yaz Sa. Uyg. **[F2]** düğmesi ile "Hayır" (devre dışı) veya "Evet" (etkin) seçimini yapın. Varsayılan ayar "Hayır" şeklindedir.
 - Tarih(Baş.)*1 **[F3]** veya **[F4]** düğmesi ile haftanın günü, hafta sayısı ve ay ayarını yapın. Varsayılan ayar "Paz/5./Mar" şeklindedir.
 - Baş. saati **[F3]** veya **[F4]** düğmesi ile yaz saati uygulamasının başlama saatini ayarlayın.
 - İleri al **[F3]** veya **[F4]** düğmesi ile yukarıdaki başlama saatinde ileri alınması gereken saati ayarlayın.
 - Tarih(Bit.)*1 (2. sayfa) **[F3]** veya **[F4]** düğmesi ile haftanın günü, hafta sayısı ve ay ayarını yapın. Varsayılan ayar "Paz/5./Eki" şeklindedir.
 - Bit. saati (2. sayfa) **[F3]** veya **[F4]** düğmesi ile yaz saati uygulamasının başlama saatini ayarlayın.
 - Geri al (2. sayfa) **[F3]** veya **[F4]** düğmesi ile yukarıdaki bitiş saatinde geri alınması gereken saati ayarlayın.
- *1 Hafta numarası için "5." seçilir ve yılın seçilen ayında 5. hafta olmazsa, seçim "4." olarak dikkate alınır.

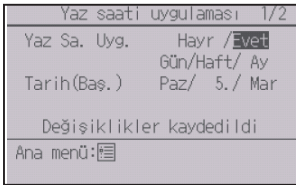

Ayarları kaydetmek için **[SEÇİM]** düğmesine basın. Bir onay ekranı görüntülenecektir.

Ekranlar arasında gezinme

- Ana menüye geri dönmek için **[MENU]** düğmesi
- Önceki ekrana geri dönmek için **[GERİ]** düğmesi

İşlev ayarları

Ana ekran

P

Düğmenin çalışması

1



Başlangıç ayar menüsünden “Ekran ayarı” seçeneğini seçin ve **SEÇİM** düğmesine basın.

2



İmleci **F1** veya **F2** düğmesi ile “Ana ekran” öğesine getirin ve **SEÇİM** düğmesine basın.

3



F3 veya **F4** düğmesiyle “Dolu” veya “Temel” seçeneğini belirleyin (bkz. sayfa 10) ve **SEÇİM** düğmesine basın.

Bir onay ekranı görüntülenecektir.

Ekranlar arasında gezinme

- Ana menüye geri dönmek için **MENÜ** düğmesi
- Önceki ekrana geri dönmek için **GERİ** düğmesi

Düğmenin çalışması

1



Başlangıç ayar menüsünden “Ekran ayarı” seçeneğini seçin ve **[SEÇİM]** düğmesine basın.

2

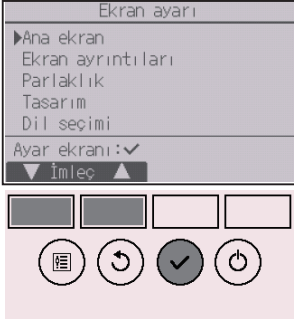

İmleci **[F1]** veya **[F2]** düğmesi ile “Ana ekran” ögesine getirin ve **[SEÇİM]** düğmesine basın.

3



[F1] veya **[F2]** düğmesi ile “Simge açıklama” seçeneğini seçin, **[F3]** veya **[F4]** düğmesi ile “Evet” veya “Hayır” seçeneklerinden istediğinizi seçin ve **[SEÇİM]** düğmesine basın.

Varsayılan ayar “Evet” şeklindedir.

Ekranlar arasında gezinme

- Ana menüye geri dönmek için **[MENÜ]** düğmesi
- Önceki ekrana geri dönmek için **[GERİ]** düğmesi

İşlev ayarları

4

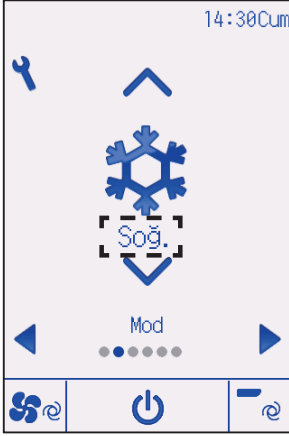

“Evet” seçili iken, ayar öğesi simgesinin açıklaması solda gösterildiği şekilde görüntülenir.

Düğmenin çalışması

1



Başlangıç ayar menüsünden “Ekran ayarı” seçeneğini seçin ve **[SEÇİM]** düğmesine basın.

2

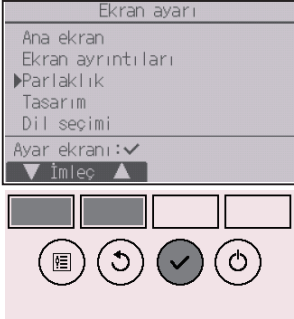

İmleci **[F1]** veya **[F2]** düğmesi ile “Parlaklık” öğesine getirin ve **[SEÇİM]** düğmesine basın.

3



Parlaklığı **[F1]** veya **[F2]** düğmesi ile değiştirin. **[F4]** düğmesi ile “Açık kal” ayarı için “AÇIK” veya “KAPA” durumu seçilebilir.

“AÇIK” seçildiğinde, arka ışık belirtilen süre geçtikten sonra kısık bir şekilde aydınlatmaya devam edecektir.

Ekranlar arasında gezinme

- Ana menüye geri dönmek için **[MENU]** düğmesi
- Önceki ekrana geri dönmek için **[GERİ]** düğmesi

İşlev ayarları

Dil seçimi

P

İşlev açıklaması

İstenen dil ayarlanabilir. Dil seçenekleri İngilizce, Fransızca, Almanca, İspanyolca, İtalyanca, Portekizce, İsveççe, Rusça, Yunanca, Türkçe, Felemenkçe, Çekçe, Macarca ve Lehçedir.

Düğmenin çalışması

1



Başlangıç ayar menüsünden “Ekran ayarı” seçeneğini seçin ve **SEÇİM** düğmesine basın.

2



İmleci **F1** veya **F2** düğmesi ile “Dil seçimi” öğesine getirin ve **SEÇİM** düğmesine basın.

3



İmleci [F1] ile [F4] arasındaki düğmelerle istediğiniz dile getirin ve ayarı kaydetmek için [SEÇİM] düğmesine basın.

Güç ilk kez açıldığında, Dil seçim ekranı görünecektir. İsteddiğiniz dili seçin. Sistem dil seçimi yapılmadan çalışacaktır.



Ayarın kaydedildiğini gösteren bir ekran görüntülenir.

Ekranlar arasında gezinme

- Ana menüye geri dönmek için [MENU] düğmesi
- Önceki ekrana geri dönmek için [GERİ] düğmesi

İşlev ayarları

Tasarım

P

Düğmenin çalışması

1

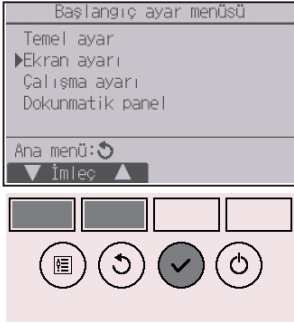

Başlangıç ayar menüsünden “Ekran ayarı” seçeneğini seçin ve **SEÇİM** düğmesine basın.

2



İmleci **F1** veya **F2** düğmesi ile “Tasarım” öğesine getirin ve **SEÇİM** düğmesine basın.

3



F4 düğmesi ile “Renk” seçeneğini seçin.

- Renk: Ekran rengi seçilebilir. (Sonraki sayfaya bakınız.)
- Beyaz: Tek renkli ekran (beyaz arka plan)
- Siyah: Tek renkli ekran (siyah arka plan)

“Beyaz” veya “Siyah” seçildiğinde, **SEÇİM** düğmesine basın. “Renk” seçildiğinde, bir sonraki sayfaya bakarak istenen rengi seçin.

4

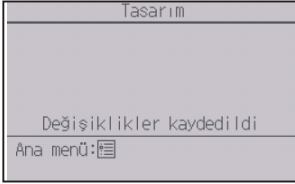

[F1] veya [F2] düğmesi ile istenen öğeyi seçin ve her bir öğe için istenen ekran rengini ayarlayın.

- Renk gölgesi: Renk gölgesini [F3] veya [F4] düğmesi ile ayarlayın. (Ayarlanabilir aralık -90 ile 89 arasındadır.)
- Desen: Rengi [F4] düğmesi ile ayarlayın.
- Renk ayarı: Renk uygulanan hedef olarak [F4] düğmesi ile "Karakter" veya "Arkaplan" seçin.

İşlev düğmelerinin altındaki örnek renk ayara göre değişecektir.

İstediğiniz rengi ayarlayın ve [SEÇİM] düğmesine basın.

Ekranlar arasında gezinme

- Ana menüye geri dönmek için [MENU] düğmesi
- Önceki ekrana geri dönmek için [GERİ] düğmesi

İşlev ayarları

Dokunmatik panel kalibrasyonu

P

Düğmenin çalışması

1



Başlangıç ayar menüsünden “Dokunmatik panel” seçeneğini seçin ve **SEÇİM** düğmesine basın.

2



İmleci **F1** veya **F2** düğmesi ile “Dokunmatik panel kalibrasyonu” öğesine getirin ve **SEÇİM** düğmesine basın.

3

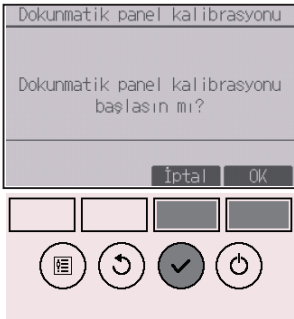

Bir onay ekranı görüntülenecektir. **F3** veya **F4** düğmesi ile “İptal” veya “OK” öğesini seçin ve **SEÇİM** düğmesine basın.

4

Ekranda görünen sırada siyah noktalara dokununuz. Hepsi dokuz tane olacaktır.

Sol üst köşeden başlayarak dokunma kalemi ile bir dakika içinde siyah noktalara dokununuz.

Dokuz adet siyah noktaya ekranda görünen sırayla dokununuz.

Dokuz siyah noktaya dokunulduğunda, kalibrasyon tamamlanmıştır ve ekran dokunmatik panel menüsüne geri dönecektir.

- Dokunmatik panele bir dakika süreyle dokunmamanız halinde, kalibrasyon iptal edilir ve ekran otomatik olarak önceki ekrana döner.
- Dokunmatik paneli doğru şekilde kalibre etmek için, noktalara dokunurken sivri, fakat keskin olmayan bir nesne kullanınız.
- * Keskin bir nesne dokunmatik panele zarar verebilir veya çizilmesine neden olabilir.

İşlev ayarları

Dokunmatik panel temizleme

P

Düğmenin çalışması

1



Başlangıç ayar menüsünden “Dokunmatik panel” seçeneğini seçin ve **SEÇİM** düğmesine basın.

2

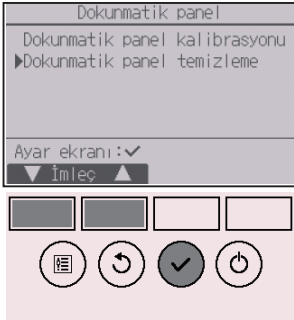

İmleci **F1** veya **F2** düğmesi ile “Dokunmatik panel temizleme” öğesine getirin ve **SEÇİM** düğmesine basın.

3

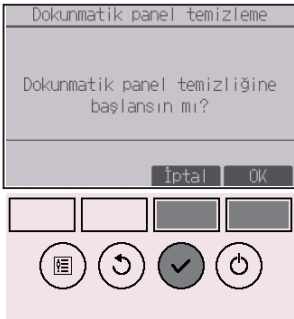

Bir onay ekranı görüntülenecektir. **F3** veya **F4** düğmesi ile “İptal” veya “OK” öğesini seçin ve **SEÇİM** düğmesine basın.

4



Bu ekran kullanıcının 30 saniyeliğine ayarları kazara deęiřtirmeksizin dokunmatik paneli silmesine imkan saęlar. Ekran 30 saniye sonra dokunmatik panel menüsüne geri dönecektir.

- Yumuřak ve kuru bir bez, deterjanlı suda hafifçe nemlendirilmiş bir bez veya etanol ile nemlendirilmiş bez ile siliniz. Asitli, alkali veya organik çözücüler kullanmayın.

İşlev ayarları

Uzaktan kumandayı sıfırla

P

İşlev açıklaması

Uzaktan kumanda fabrika ayarlarına sıfırlanabilir. Aşağıdaki veriler sıfırlanacaktır.
Uzaktan kumanda sıfırlandıktan sonra otomatik olarak başlatılır.

Zamanlayıcı ayarı, Haftalık zamanlayıcı ayarı, Dış ünite sessiz modu ayarı, Enerji tasarrufu ayarı, Enerji tasarruf seçeneği ayarı, Saat ayarı, Yaz saati uygulaması ayarı, Ana ekran ayarı, Parlaklık ayarı, Ekran ayrıntıları ayarı, Tasarım ayarı, Otomatik modu ayarı, Model adı ayarı, Seri No. ayarı, Satıcı bilgisi ayarı, Hata bilgisi, Yönetici parolası, Bakım parolası

Düğmenin çalışması

1



Servis menüsünden “Diğerleri” seçeneğini seçin ve **SEÇİM** düğmesine basın.

2

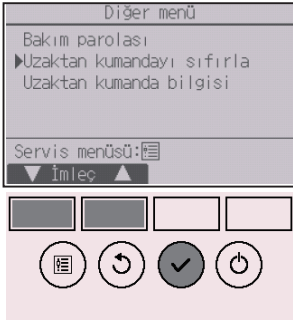

İmleci **F1** veya **F2** düğmesi ile “Uzaktan kumandayı sıfırla” öğesine getirin ve **SEÇİM** düğmesine basın.

3

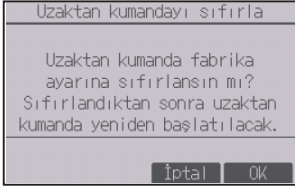

[F4] düğmesi ile “OK” düğmesini seçin.

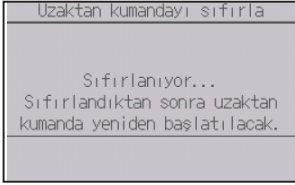
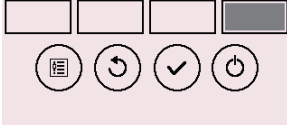

Uzaktan kumanda sıfırlandıktan sonra otomatik olarak başlatılır.

İşlev ayarları

Uzaktan kumanda bilgisi



İşlev açıklaması

Kullanılmakta olan uzaktan kumanda bilgilerini kontrol edebilirsiniz.

Düğmenin çalışması

1



Servis menüsünden “Diğerleri” seçeneğini seçin ve **SEÇİM** düğmesine basın.

2

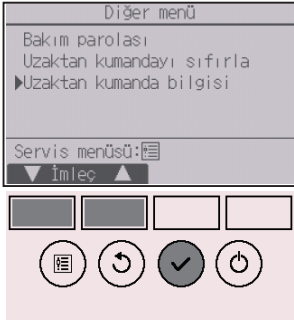



İmleci **F1** veya **F2** düğmesi ile “Uzaktan kumanda bilgisi” öğesine getirin ve **SEÇİM** düğmesine basın.

3

Uzaktan kumanda bilgisi	
Model adı	
S/W Ver	00.10
Seri No.	
Geri:↺	









Uzaktan kumandanın model adı, yazılım versiyonu ve seri numarasını kontrol edebilirsiniz.

Sorun Giderme

Hata bilgisi

Bir hata oluştuğunda, aşağıdaki ekran görüntülenir ve çalışma LED'i yanıp söner. Hata durumunu kontrol edin, çalışmayı durdurun ve satıcınıza danışın.

Düğmenin çalışması

1



Hata kodu, hata ünitesi, soğutucu adresi, ünite model adı, hatanın oluştuğu tarih ve saat ile seri no. görüntülenir.

Model adı ve Seri No. yalnızca söz konusu bilgiler kaydedilmişse görüntülenir.

Sonraki sayfaya gitmek için **F1** veya **F2** düğmesine basın.



İletişim bilgileri (satıcının telefon numarası), söz konusu bilgiler kaydedilmişse görüntülenir.

2

Hata bilgisi		1/2
Hata kodu	P2	
Hata ünitesi	IÜ	0 Ünt#1
Oluş Saati	--/--	12:34
Model adı	PLZ	
Seri No.		
Sıfırla hatası: Sıfırla düğ.		
▼ Sayfa	▲	Sıfırl

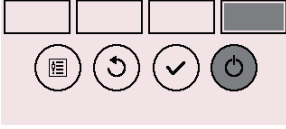

Hata sıfırla	
Geçerli hatayı sıfırla?	
İptal OK	

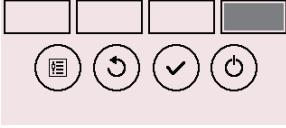

Hata sıfırla	
Hata sıfırla	
Ana menü:	☰

Meydana gelen hatayı sıfırlamak için **AÇIK/KAPALI** düğmesine veya **F4** düğmesine basın.

AÇIK/KAPALI çalışması yasakken hatalar sıfırlanamaz.

F4 düğmesi ile “OK” düğmesini seçin.

Bir onay ekranı görüntülenecektir.

Ekranlar arasında gezinme

- Ana menüye geri dönmek için **MENÜ** düğmesi

Sorun Giderme

Hata bilgilerini kontrol etme

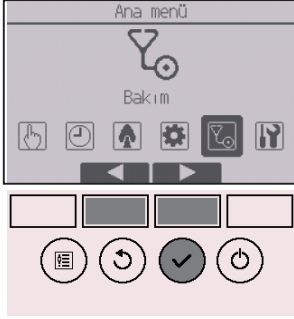

Herhangi bir hata yokken, hata bilgilerinin 2/2 sayfası (bkz. sayfa 74), menü çalışmasından görüntülenebilir.

Ana menüden “Bakım” menüsü seçeneğini seçin ve

SEÇİM düğmesine basın.

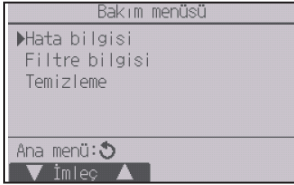

Hata bilgisi ekranını görüntülemek için, Bakım menüsünden “Hata bilgisi” menüsünü seçin. Hatalar sıfırlanamaz.

Doluluk yok-otomatik kapanma

Birim, enerji tasarrufu seçeneğinin Doluluk yok-otomatik kapanma işlevinden dolayı durduğunda, 3D i-See sensor panel modeli için aşağıdaki ekran görünecektir. 3D i-See sensor ayarı için iç ünitenin Talimat Kılavuzuna başvurun.

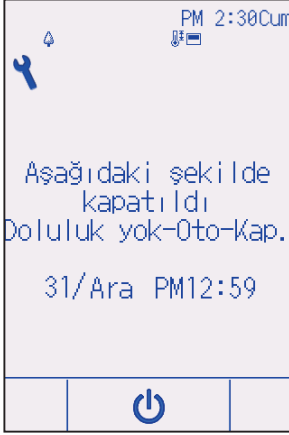

Bakım

Filtre bilgisi



Filtrelerin temizlenme zamanı geldiğinde Durum ekranında  ve Dolu modda Ana ekranda görüntülenir.

Bu simge görüntülendiğinde filtreleri yıkayın, temizleyin veya değiştirin. Ayrıntılar için iç ünitenin Kullanım Kılavuzu'na bakın.

Düğmenin çalışması

1



Bakım menüsünden “Filtre bilgisi” seçeneğini seçin ve **SEÇİM** düğmesine basın.

2



Filtre işaretini yeniden ayarlamak için **F4** düğmesine basın. Filtrenin nasıl temizleneceği hakkında bilgi almak için iç ünitenin Kullanım Kılavuzu'na bakın.

3



[F4] düğmesi ile "OK" düğmesini seçin.

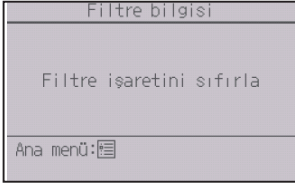

Bir onay ekranı görüntülenecektir.

Ekranlar arasında gezinme

- Ana menüye geri dönmek için [MENU] düğmesi
- Önceki ekrana geri dönmek için [GERİ] düğmesi



Durum ekranında  görüntülenirken ve Ana ekranda Dolu modda görüntülendiğinde, sistem merkezi olarak kontrol edilir ve filtre işareti sıfırlanamaz.

İki veya daha fazla iç ünite bağlıysa, filtre türüne bağlı olarak, her ünite için filtre temizleme zamanı farklı olabilir.

Ana üniteadaki filtrenin temizlenme zamanı gelmişse,  simgesi görüntülenir.

Filtre işareti sıfırlandığında, tüm ünitelerin toplu çalışma süresi sıfırlanacaktır.

Belli bir çalışma aralığından sonra, iç ünitelerin normal hava kalitesi bulunan bir ortama kurulup kurulmadığına bağlı olarak  simgesi görüntülenir. Hava kalitesine bağlı olarak, filtrenin daha sık temizlenmesi gerekebilir.

Filtrelerin temizlenmesinin gerektiği toplam zaman modele bağlıdır.

Teknik Özellikler

Kumanda teknik özellikleri

	Teknik Özellik
Ürün boyutu	Standart (PAR-CT01MAA(R)-SB/PAR-CT01MAA-S): 65(W) × 120(H) × 14,1(D) mm (2 9/16 × 4 23/32 × 9/16 [in]) (çıkıntı oluşturan bölüm dahil değildir)
	Premium (PAR-CT01MAA(R)-PB): 68(W) × 120(H) × 14,1(D) mm (2 11/16 × 4 23/32 × 9/16 [in]) (çıkıntı oluşturan bölüm dahil değildir)
Net ağırlık	Standart (PAR-CT01MAA(R)-SB/PAR-CT01MAA-S): 0,09 kg (13/64 lbs)
	Premium (PAR-CT01MAA(R)-PB): 0,10 kg (7/32 lbs)
Nominal güç kaynağı voltajı	12 VDC (iç ünitelerinden temin edilen)
Güç tüketimi	0,6 W
Kullanım ortamı	Sıcaklık 0 ~ 40°C (32 ~ 104°F) Nem %25 ~ %90 BN (çiy yoğuşması olmadan)
Malzeme	Standart (PAR-CT01MAA(R)-SB/PAR-CT01MAA-S) Ana gövde: ABS
	Premium (PAR-CT01MAA(R)-PB) Ana gövde: ABS Yan plaka: Alüminyum

İşlev listesi (1 Ekim 2017 itibariyle)

○ : Desteklenen × : Desteklenmeyen

	İşlev	CITY MULTI	Mr. SLIM	Gerekli şifre
Güç	Güç AÇIK/KAPALI	○	○	-
Ayarlar	Çalışma modu	○	○	-
	Otomatik (çift ayar noktası) modu	○	○	-
	Ön ayar sıcaklığı	○	○	-
	Fan hızı	○	○	-
	Kanat	○	○	-
	İç Kanat	○	○	-
	Havalandırma	○	○	-
Çalışma menüsü	Yüksek Güç	×	○	-
	Manuel kanat açısı	○	○	-
	3D i-See sensor	○	○	-
Zamanlayıcı menüsü	Zamanlayıcı (Açma/Kapama zamanlayıcı)	○	○	yönetici
	Zamanlayıcı (Otomatik kapanma zamanlayıcı)	○	○	yönetici
	Haftalık zamanlayıcı	○	○	yönetici
	Dış ünite sessiz modu	○	○	yönetici
	Gece ayarı	○	○	yönetici
Enerji tasarruf menüsü	Sıcaklık aralığı kısıtlaması	○	○	yönetici
	Çalışma kilidi işlevi	○	○	yönetici
	Otomatik dönüş	○	○	yönetici
	Zamanla	×	○	yönetici
Başlangıç ayarı menüsü	Saat	○	○	yönetici
	Saat görünüm biçimi ayarı	○	○	yönetici
	Yaz saati uygulaması	○	○	yönetici
	Ana ekran	○	○	yönetici
	Simge açıklaması	○	○	yönetici
	Parlaklık	○	○	yönetici
	Dil seçimi	○	○	yönetici
	Tasarım	○	○	yönetici
	Dokunmatik panel kalibrasyonu	○	○	yönetici
	Dokunmatik panel temizleme	○	○	yönetici
Parola (Yönetici)	○	○	yönetici	
Servis menüsü	Uzaktan kumandayı sıfırla	○	○	bakım
	Uzaktan kumanda bilgisi	○	○	bakım
	Test çalıştırması	○	○	bakım
	Model bilgisi girişi	○	○	bakım
	Satıcı bilgi girişi	○	○	bakım
	İşlev ayarı	○	○	bakım
	Düzensiz bakım (Bakım)	×	○	bakım
Bakım menüsü	Otomatik alçalan panel	○	○	-
	Hata bilgisi	○	○	-
	Filtre bilgisi	○	○	-

* Desteklenen işlevler ünite modeline göre değişiklik gösterir.

Teknik Özellikler

Bir arada kullanılabilen/kullanılmayan işlevlerin listesi

	Yüksek Güç	Açma/Kapama zamanlayıcı	Otomatik kapanma zamanlayıcı	Haftalık zamanlayıcı	Dış ünite sessiz modu	Sıcaklık aralığı	Çalışma kilidi	Otomatik dönüş	Enerji tasarruf zamanlaması	Gece ayarı
Yüksek Güç		○	○	○	△ 1	○	△ 2	○	△ 1	○
Açma/Kapama zamanlayıcı	○		○	× 1	○	○	○	○	○	△ 3
Otomatik kapanma zamanlayıcı	○	○		○	○	○	○	○	○	△ 4
Haftalık zamanlayıcı	○	× 1	○		○	○	○	○	○	△ 5
Dış ünite sessiz modu	△ 1	○	○	○		○	○	○	○	○
Sıcaklık aralığı	○	○	○	○	○		○	× 2	○	△ 6
Çalışma kilidi	△ 2	○	○	○	○	○		○	○	○
Otomatik dönüş	○	○	○	○	○	× 2	○		○	△ 7
Enerji tasarruf zamanlaması	△ 1	○	○	○	○	○	○	○		○
Gece ayarı	○	△ 3	△ 4	△ 5	○	△ 6	○	△ 7	○	

○ : Bir arada kullanılabilir × : Bir arada kullanılmaz △ : Kısıtlıdır

△ 1: Yüksek hızda çalıştırma daha yüksek önceliğe sahip olduğu için yüksek güçte çalıştırma tamamlandıktan sonra bu işlev etkinleştirilir.

△ 2: İşlemlerin bazıları kilitlemeden bu işlev çalıştırılmaz.

△ 3: Ünite, Açma/Kapama zamanlayıcı ayarı ile çalışırken gece ayar işlevi kullanılmaz.

△ 4: Gece ayarında çalışma için Otomatik kapanma işlevi kullanılmaz.

△ 5: Ünite, Haftalık zamanlayıcı ayarı ile çalışırken gece ayar işlevi kullanılmaz.

△ 6: Gece ayarında çalışma için Sıcaklık aralığı ayarı kullanılmaz.

△ 7: Gece ayarında çalışma için Otomatik dönüş işlevi kullanılmaz.

× 1: Açma/Kapama zamanlayıcısı daha yüksek önceliğe sahip olduğu için Haftalık zamanlayıcı ayarı etkin olmaz.

× 2: Sıcaklık aralığı ayarı daha yüksek önceliğe sahip olduğu için Otomatik dönüş işlevi kullanılmaz.

CITY MULTI-kontrollsystem
och luftkonditioneringsapparater Mitsubishi Mr. SLIM

MA-pekskärmfjärrkontroll

PAR-CT01MAA-PB

PAR-CT01MAA-SB

PAR-CT01MAA-S

PAR-CT01MAR-PB

PAR-CT01MAR-SB

Instruktionsbok

Svenska

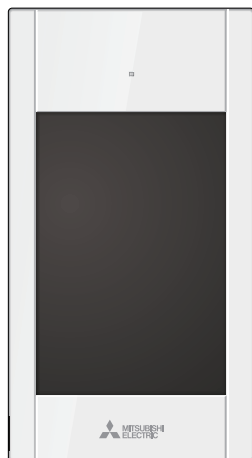

Läs igenom instruktionerna i denna manual innan produkten används.

Behåll för framtida bruk.

Se till att denna CD-ROM-skiva och installationshandboken lämnas över till de nya användarna om apparaten byter ägare.



För att säkerställa fjärrkontrollens säkerhet och korrekta bruk, ska den bara installeras av kvalificerad personal.

Innehåll

Säkerhetsåtgärder	4
Kontrollens komponenter	6
Kontrollens gränssnitt - Statusdisplay/primär display	6
Kontrollgränssnitt - Menyskärm	8
Display - Statusdisplay/primär display	10
Menystruktur och symboler	12
Menystruktur	12
Ikonförklaring	15
Grundläggande funktioner	16
PÅ/AV	16
Inställningar för funktionsläge, temperatur, fläkthastighet, blad, spjäll och ventilation (Lossnay)	17
Navigera genom meny	22
Huvudmeny	22
Navigera genom Huvudmenyn	24
Funktionsinställningar	25
Hög effekt	25
Manuell fläktbladsvinkel	26
Timer (På/Av-timer)	29
Timer (Auto-Av-timer)	32
Veckotimer	34
Utomhusenhetens tyst läge	37
Nattemperatur	40
Begränsning	43
Energispar	49
Klocka	54
Sommartid	56
Primär display	58
Ikonförklaring	59
Ljusstyrka	61
Språkval	62
Utformning	64
Kalibrering av pekskärmen	66
Pekskärmrengöring	68
Återställ fjärrkontrollen	70
Fjärrkontrollsinformation	72
Felsökning	74
Felinformation	74
Ingen upptagenhets-auto-av	77
Underhåll	78
Filterinformation	78
Specifikationer	80
Kontrollens specifikationer	80
Funktionslista (den 1 oktober 2017)	81
Lista över funktioner som kan/inte kan användas tillsammans	82

Säkerhetsåtgärder

- Läs igenom säkerhetsåtgärderna noggrant innan du använder enheten.
- Följ säkerhetsanvisningarna noggrant för en trygg användning.

 VARNING	Anger att det finns risk för allvarliga personskador eller dödsfall.
 FÖRSIKTIGHET	Anger att det finns risk för allvarliga person- eller materialskador.

- Lämna över den här handboken till slutanvändaren, för framtida bruk, när du läst klart den.
- Spara den här handboken för framtida bruk och konsultera den så fort du är osäker över något. Handboken bör lämnas över till serviceteknikerna vid en eventuell reparation eller flytt av fjärrkontrollen. Se till att denna handbok lämnas över till de nya användarna om apparaten byter ägare.

Allmänna säkerhetsåtgärder

VARNING

Installera inte enheten på platser där det finns stora mängder oljor, ånga, organiska lösningsmedel eller korroderande gaser, som svavelhaltig gas, eller på platser där man regelbundet använder sura eller alkaliska lösningar eller sprejer. Dessa substanser kan påverka enhetens prestanda negativt och orsaka frätskador på vissa av enhetens komponenter. Detta kan leda till elektriska stötar, tekniska fel, rökutveckling eller brand.

Rengör aldrig kontrollen med vatten eller några andra vätskor för att minska risken för kortslutning, läckström, elektriska stötar, tekniska fel, rökutveckling eller brand.

Tryck aldrig på strömbrytarna/knapparna och rör aldrig några andra elektriska delar med blöta händer för att minska risken för elektriska stötar, tekniska fel, rökutveckling eller brand.

När enheten desinficeras med alkohol är det viktigt att rummet är väl ventilerat. Ångorna från alkoholen kring enheten kan orsaka eld eller explosion när enheten sätts igång.

Om du måste spreja något kemiskt ämne i närheten av kontrollen bör du slå av och täcka över den för att minska risken för personskador och elektriska stötar.

Om du måste rengöra, underhålla eller besiktiga kontrollen bör du först slå av den och bryta strömmen till den för att minska risken för personskador och elektriska stötar.

Om något ovanligt (exempelvis lukt av brand) uppmärksammas, stoppa driften, stäng av strömmen och kontakta din återförsäljare. Fortsatt användning av produkten kan medföra risk för elektriska stötar, fel eller brand.

Installera alla kåpor på ett korrekt sätt för att hålla kontrollen fri från damm och fukt. Om damm eller vatten ansamlas i enheten kan det leda till elektriska stötar, rökutveckling eller brand.

FÖRSIKTIGHET

Placera inte lättantändliga material och använd inte lättantändliga sprejer i närheten av kontrollen för att minska risken för brand eller explosion.

Spreja aldrig insektsmedel eller andra lättantändliga sprejer mot kontrollen för att minska risken för skador på den.

För att minska risken för miljöförstöring, kontakta en godkänd aktör för att göra dig av med fjärrkontrollen på ett riktigt sätt.

Peka inte på pekskärmen, strömbrytarna eller knapparna med ett spetsigt eller vasst föremål för att minska risken för elektriska stötar eller tekniska fel.

Vissa delar av kontrollen har vassa kanter. Undvik att komma i kontakt med dessa delar för att minska risken för personskador och elektriska stötar.

Behandla kontrollens glasdelar försiktigt för att inte skadas av trasigt glas.

Bär skyddsutrustning vid arbete på kontrollen för att minska risken för personskador.

Säkerhetsåtgärder vid flytt eller reparation av kontrollen

VARNING

Kontrollen får endast repareras eller flyttas av kvalificerade tekniker. Öppna eller modifiera inte kontrollen.
Felaktig installation eller reparation medför risk för skador, elektriska stötar eller brand.

FÖRSIKTIGHET

Rör inte kretskortet med händerna eller något verktyg och låt inte damm ansamlas på kretskortet för att minska risken för kortslutning, läckström, elektriska stötar, brand eller tekniska fel.

Övriga säkerhetsåtgärder

Använd endast lämpliga verktyg för att installera, besiktiga och reparera kontrollen för att undvika att skada den.

Denna kontroll är endast avsedd för användning med BMS-systemet (Building Management System) från Mitsubishi Electric. Om du använder den här kontrollen med något annat system eller för något annat ändamål kan det orsaka tekniska fel.

Denna apparat är inte avsedd att användas av personer (inklusive barn) med nedsatta fysiska, sensoriska eller mentala förmågor, eller som saknar erfarenhet och kunskap, om de inte övervakas eller instrueras om användandet av apparaten av någon som ansvarar för deras säkerhet.
Barn bör övervakas så att de inte kan leka med apparaten.

Använd inte bensen, thinner eller kemiska trasor för att rengöra kontrollen för att undvika att den missfärgas. Gör så här för att rengöra kontrollen: Torka av den med en ren och mjuk trasa som dopats i vatten med ett mildt rengöringsmedel. Torka bort rengöringsmedlet med en fuktig trasa och vattnet med en torr trasa.

Tillhandahåll skydd mot statiskt elektricitet för att undvika att kontrollen skadas.

Den här apparaten är avsedd att användas av experter eller utbildade användare i butiker, i lätt industri och i jordbruk eller för kommersiell användning av lekmän.

Om nätkabeln är skadad måste den bytas av tillverkaren, dennes serviceombud eller annan kvalificerad person för att undvika risker.

Kontrollens komponenter

Kontrollens gränssnitt - Statusdisplay/primär display

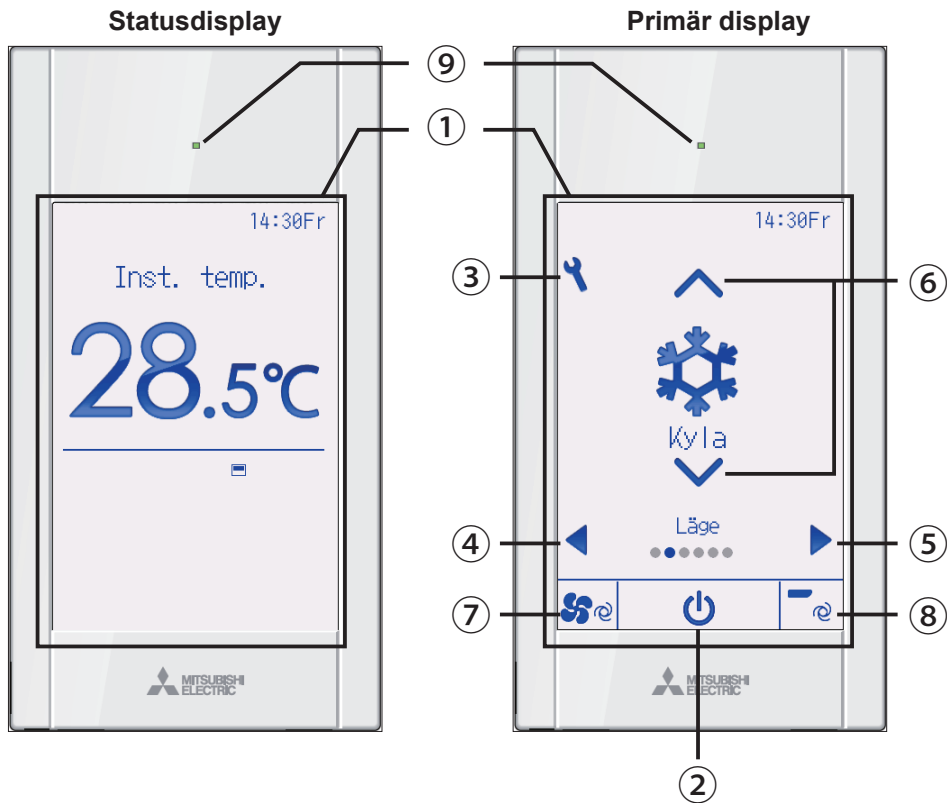

① Pekskärmspanel och bakgrundsbelyst fullfärgs-LCD

Inställningar visas.

När bakgrundsljuset är släckt kommer ett tryck var som helst att växla skärmen till statusdisplayen. Om statusdisplayen visas kommer ett tryck var som helst att växla skärmen till den primära displayen.

② Knappen **PÅ/AV**

Tryck för att sätta inomhusenheten i läge PÅ/AV.

③ Knappen **Inställning**

Tryck för att visa huvudmenyn.

När menyhanteringen är låst krävs det ett administratörslösenord.

④ Knappen **◀**

Tryck för att växla mellan inställningarna i följande ordning: spjäll, ventilation, blad, fläkthastighet, funktionsläge och förinställd temperatur.

⑤ Knappen **▶**

Tryck för att växla mellan inställningarna i följande ordning: förinställd temperatur, funktionsläge, fläkthastighet, blad, ventilation och spjäll.

⑥ Knappen **▲ ▼**

Tryck för att ändra innehållet i inställningen som valts i ④ och ⑤ ovan.

⑦ Genvägsknapp för fläkthastighet

Tryck för att gå direkt till inställningsskärmen för fläkthastighet.

⑧ Genvägsknapp för blad

Tryck för att gå direkt till inställningsskärmen för blad.

⑨ PÅ/AV-lampa

Lampan lyser grönt när enheten är i drift, om inte "LED-belysning" ställts in till "Nej". Den blinkar när fjärrkontrollen startar eller när ett fel uppstår.

När PÅ/AV-driften är låst visas inte ② .

När inställningen växlas med knappen ④ eller ⑤ , om användningen av vald inställning är låst, visas den inte.

Om användningen av fläkthastigheten eller bladet är låst visas inte posten ⑦ eller ⑧ .

Inställningens innehåll kan inte ändras med knappen ⑥ när inställningen styrs centralt av systemkontrollen.

Kontrollens komponenter

Kontrollgränssnitt - Menyskärm

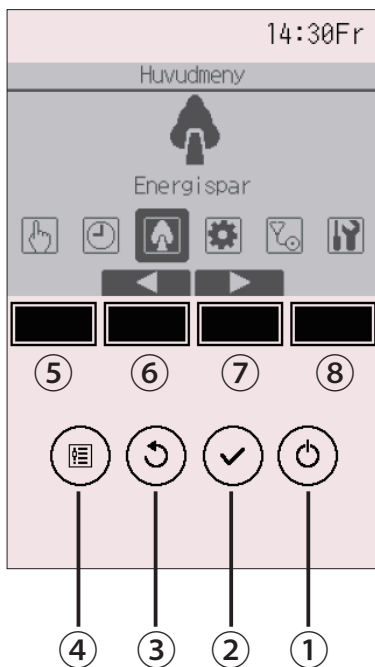

① Knappen **PÅ/AV**

Tryck för att sätta inomhusenheten i läge PÅ/AV.

② Knappen **VÄLJ**

Tryck för att spara inställningen.

③ Knappen **TILLBAKA**

Tryck för att återgå till föregående skärm. Tryck på den här knappen när huvudmenyn visas för att visa statusdisplayen.

④ Knappen **MENY**

Sidan 24

Tryck för att visa huvudmenyn.

⑤ Funktionsknappen **F1**

Menyskärm: Knappens funktion varierar beroende på skärm.

⑥ Funktionsknappen **F2**

Huvudmeny: Tryck för att flytta markören åt vänster.

Menyskärm: Knappens funktion varierar beroende på skärm.

⑦ Funktionsknappen **F3**

Huvudmeny: Tryck för att flytta markören åt höger.

Menyskärm: Knappens funktion varierar beroende på skärm.

⑧ Funktionsknappen **F4**

Menyskärm: Knappens funktion varierar beroende på skärm.

Funktionsknapparnas funktion ändras beroende på meny. Se knappguiden som visas längst ner på LCD-skärmen för att se vilken funktion de har i en viss meny.

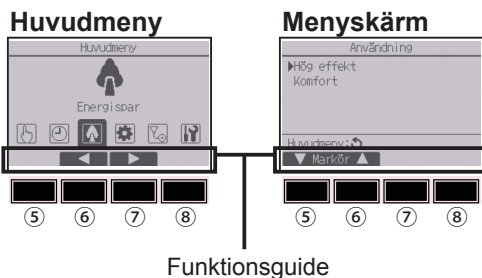

Kontrollens komponenter

Display - Statusdisplay/primär display

Statusdisplayen och den primära displayen kan visas i två olika lägen: "Högsta" och "Bas".

Fabriksinställningen är "Högsta". Se hur du växlar läge på sidan 58.

Högsta

* Alla symboler visas för förklaring.

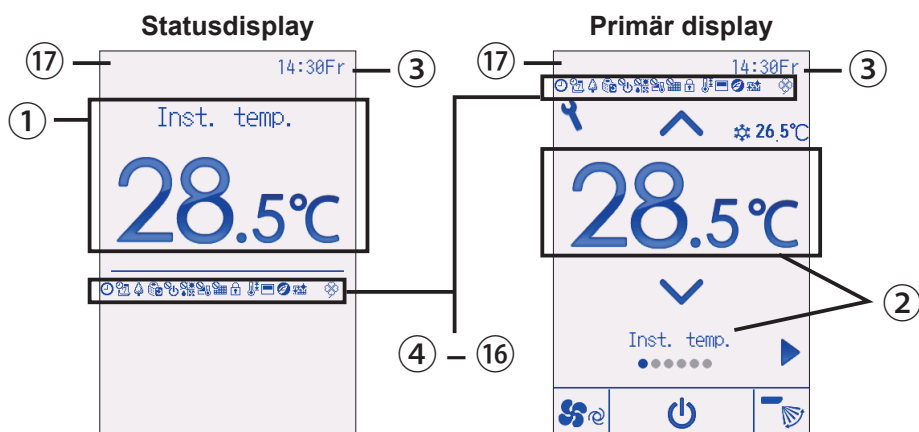

Bas

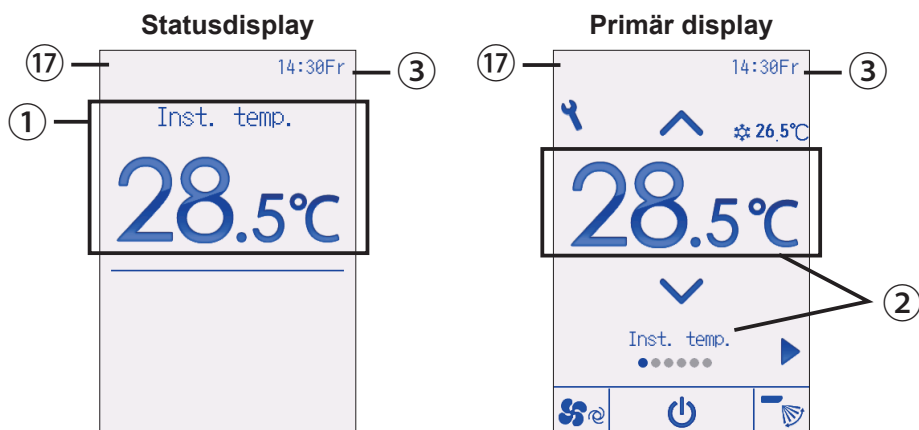

① Förinställd temperatur eller rumstemperatur

Förinställd temperatur eller rumstemperatur visas här.
(Se installationshandboken.)

② Inställningar och deras innehåll **Sidan 17**

Inställningarna "Förinställd temperatur" ↔ "Funktionsläge" ↔ "Fläkthastighet" ↔ "Blad" ↔ "Ventilation" ↔ "Spjäll" och deras innehåll visas här.
"Centralstyrd" visas under en period när ett centralstyrt val används.

③ Klocka

Aktuell tid visas här.
(Se installationshandboken.)

④ **Sidan 29, 32, 40**

Visas när "På/Av-timer" (Sida 29), "Nattemperatur" (Sida 40) eller "Auto-Av"-timerfunktion (Sida 32) är aktiverad.

 visas när timern avaktiveras via det centrala styrsystemet.

⑤ **Sidan 34**

Visas när veckotimern är aktiverad.

⑥ **Sidan 51**

Visas när enheterna används i energisparläge. (Visas inte på vissa modeller av inomhusenheter)

⑦ **Sidan 37**

Visas när utomhusenheter används i tyst läge.

⑧ **Sidan 37**

Visas när PÅ/AV-funktionen är centralstyrd.

⑨ **Sidan 46**

Visas när lägesfunktionen är centralstyrd.

⑩ **Sidan 46**

Visas när den förinställda temperaturen är centralstyrd.

⑪ **Sidan 46**

Visas när funktionen för filteråterställning är centralstyrd.

⑫ **Sidan 46**

Visas när knapparna är låsta.

⑬ **Sidan 43**

Visas när det förinställda temperaturintervallet är centralstyrt.

⑭ **Sidan 43**

Visas när fjärrkontrollens inbyggda termistor är aktiverad för att övervaka rumstemperaturen.

 visas när termistorn på inomhusenheten är aktiverad för att övervaka rumstemperaturen.

⑮ **Sidan 78**

Visas när en energisparande åtgärd utförs med en "3D i-See sensor"-funktion.

⑯ **Sidan 78**

Visar när filtret behöver underhållas.

⑰ **Visning av preliminärt fel**

En felkod visas under det preliminära felet.

Menystruktur och symboler

Menystruktur

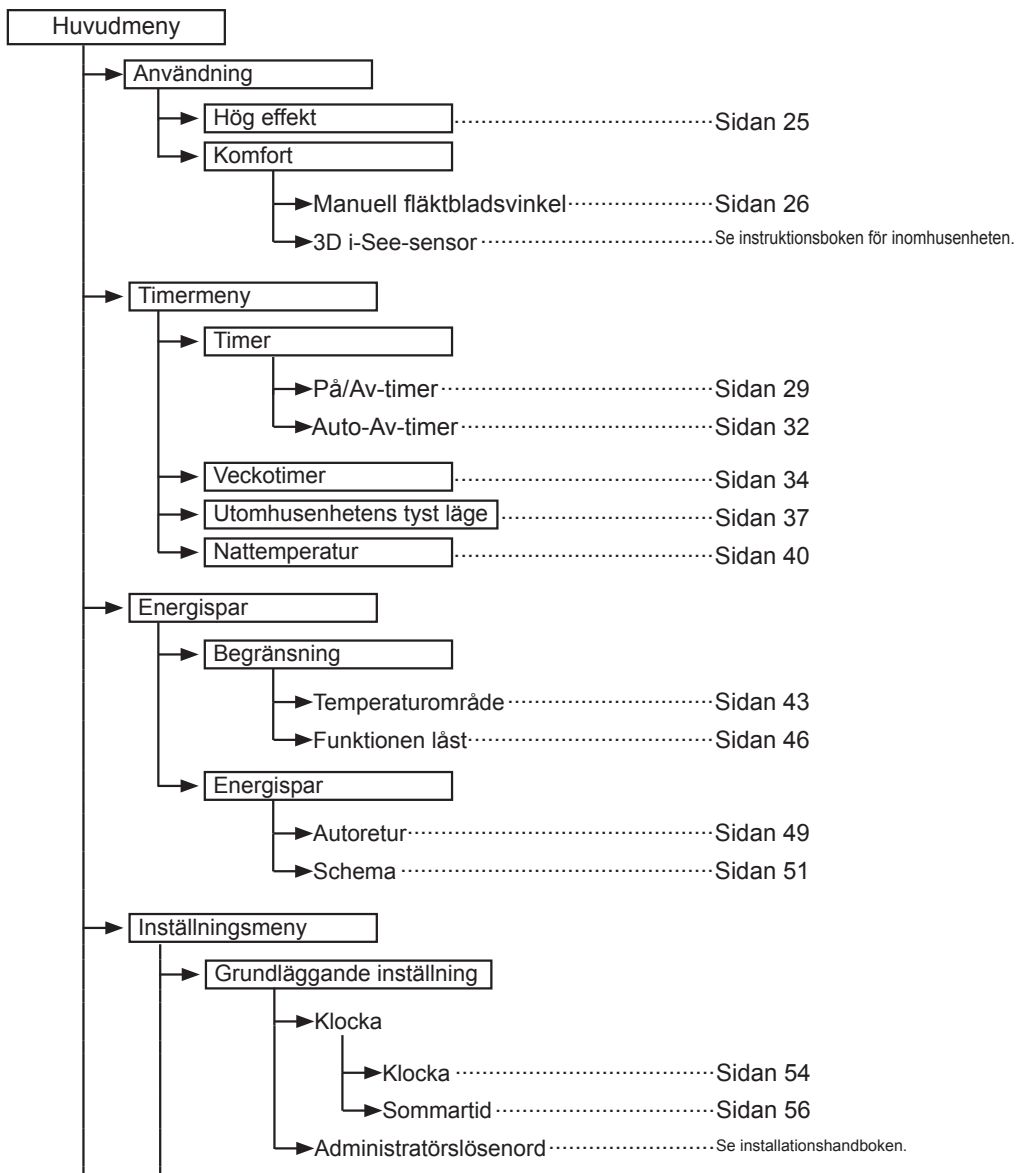

→	Displayinställning	
	→ Primära displayen	Sidan 58
	→ Displayinformation (Ikonförklaring etc.)	Se installationshandboken.
	→ Ljusstyrka	Sidan 61
	→ Språkval	Sidan 62
	→ Utformning	Sidan 64
→	Driftinställning	
	→ Autoläge	Se installationshandboken.
→	Pekskärmspanel	Sidan 66
→	Underhållsmeny	
	→ Felinformation	Sidan 74
	→ Filterinformation	Sidan 78
	→ Rengöring	
	→ Automatiskt nedåtgående panel	Se instruktionshandboken som medföljde den automatiska uppåtgående panelen.
	→ Nedåtgående drift	Se instruktionshandboken som medföljde den automatiska uppåtgående panelen.
	→ Nedåtgående justering	Se instruktionshandboken som medföljde den automatiska uppåtgående panelen.
→	Service meny	
	→ Testkörningsmeny	
	→ Testkörning	Se inomhusenhetens installationshandbok.
	→ Testkör dräneringspump	Se inomhusenhetens installationshandbok.
	→ Underhållsinformation	Se inomhusenhetens installationshandbok.
	→ För in modellnamn	Se inomhusenhetens installationshandbok.
	→ För in serienummer	Se inomhusenhetens installationshandbok.
	→ För in återförsäljarinformation	Se inomhusenhetens installationshandbok.
	→ Initiera underhållsinformation	Se inomhusenhetens installationshandbok.

Menystruktur och symboler

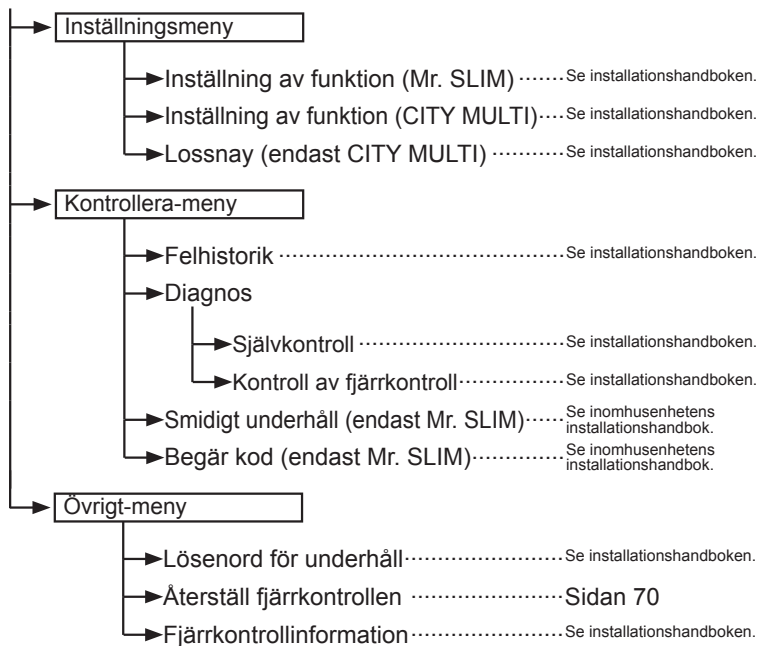

Alla funktioner är inte tillgängliga på alla modeller av inomhusenheter.

Kontrollfunktion

Timer



Tabellen nedan sammanfattar de fyrkantiga bilder som används i denna handbok.



Administratörens eller underhållspersonalens lösenord måste fyllas i på skärmen för lösenordsinmatning för att ändra inställningar. Det finns inga inställningar som kan hoppa över detta.



F1 F2 F3 F4

F1 : Tryck för att flytta markören åt vänster.

F2 : Tryck för att flytta markören åt höger.

F3 : Tryck för att minska värdet med 1.

F4 : Tryck för att öka värdet med 1.

* Ändringar kan inte göras om inte rätt lösenord har matats in.



Anger inställningar som endast kan göras när enheten är igång.



Anger inställningar som endast kan göras när enheten inte är igång.



Anger inställningar som endast kan göras när enheten inte är i gång i läge Kyla, Värme eller Auto.



Anger funktioner som inte är tillgängliga när knapparna är låsta eller då systemet är centralstyrt.

Grundläggande funktioner

PÅ/AV



Använda knappar

PÅ



Tryck på knappen **PÅ/AV**.

PÅ/AV-lampan börjar lysa grönt och maskinen startar.

När "LED-belysning" är inställd till "Nej", kommer PÅ/AV-lampan inte att tändas.

Knappen **PÅ/AV**

AV



Tryck på knappen **PÅ/AV** igen.

PÅ/AV lampan släcks och maskinen stoppar.



Använda knappar

Funktionsläge



Varje gång du trycker på någon av knapparna och bläddras de följande driftslägena igenom.

Välj önskat funktionsläge.



Kyla



Torr



Fläkt



Auto



Värme

- Funktionslägen som inte är tillgängliga för den anslutna inomhusenhetens modell kommer inte att visas på displayen.

Vad den blinkande lägessymbolen betyder

Symbolen kommer blinka när andra inomhusenheter i samma kylningssystem (kopplad till samma utomhusenhet) redan körs i ett annat läge. När så är fallet, kan övriga enheter i samma grupp bara användas i samma läge.

<Läget "Auto" (dubbelt börvärde)>

När användningsläget är inställt till "Auto" (dubbelt börvärde), kan två förinställda temperaturer ställas in (en var för kylning och uppvärmning). Beroende på rumstemperaturen, kommer inomhusenheten automatiskt att fungera i antingen läget "kyla" eller "värme", och hålla rumstemperaturen inom det förinställda intervall.

Diagrammet nedan visar användningsmönstret av inomhusenheten körd i läget "Auto" (dubbelt börvärde).

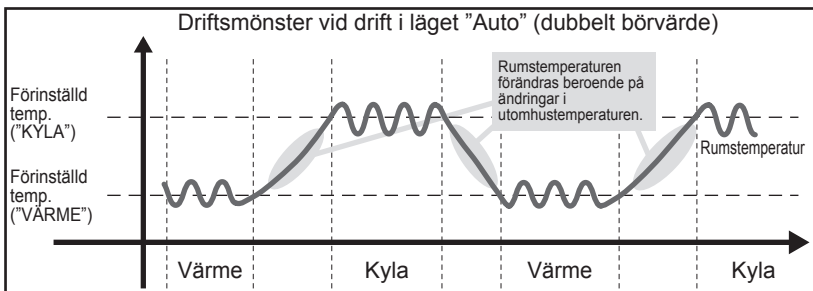

Grundläggande funktioner

Förinställd temperatur

<"Kyla", "Torr", "Värme" och "Auto" (enkelt börvärde)>

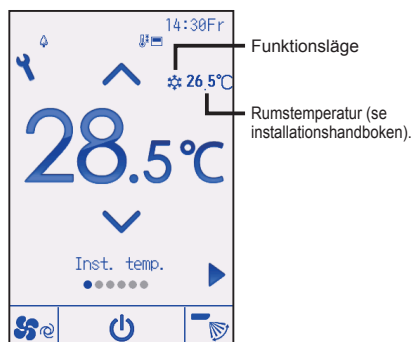

Tryck på knappen ▼ för att minska den förinställda temperaturen, och tryck på knappen ▲ för att öka den.

- Se tabellen på sidan 19 för de tillgängliga temperaturintervallen för olika funktionslägen.
- Det förinställda temperaturintervallet kan ställas in på Fläkt/Ventilation.
- Förinställd temperatur visas antingen i Celsius, i steg om 0,5 eller 1 grad, eller i Fahrenheit, beroende på inomhusenhetens modell och displayens inställningsläge på fjärrkontrollen.

<Läget "Auto" (dubbelt börvärde)>

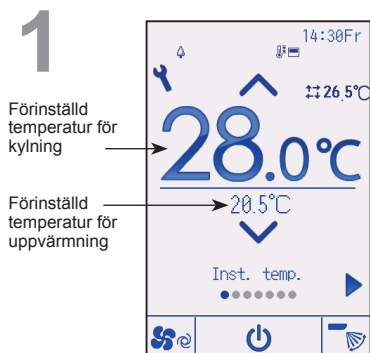

Aktuella förinställda temperaturer visas.

Varje tryck på någon av knapparna ◀ och ▶ växlar mellan de förinställda temperaturerna för kylning och uppvärmning.

2

Förinställd temperatur för kylning

Förinställd temperatur för uppvärmning

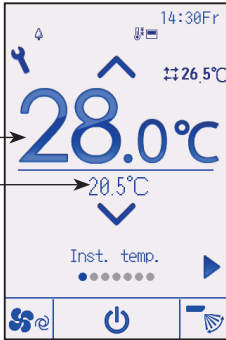

Tryck på knappen ▼ för att minska den valda temperaturen, och tryck på knappen ▲ för att öka den.

- Se tabellen på tabellen nedan för de tillgängliga temperaturintervallen för olika funktionslägen.
- De förinställda temperaturinställningarna för kylning och uppvärmning i läget "Auto" (dubbelt börvärde) kan även användas av lägena "Kyla"/"Torr" och "Värme".
- Förinställda temperaturer för kylning och uppvärmning i läge "Auto" (dubbelt börvärde) måste uppfylla kraven nedan:

- Förinställd kylningstemperatur är högre än förinställd uppvärmningstemperatur.
- Det lägsta kravet på temperaturskillnaden mellan förinställda temperaturer för kylning och uppvärmning (varierar med anslutna modeller av inomhusenheterna) är uppfyllt.
- Om de förinställda temperaturerna är inställda på ett sätt som inte uppfyller det lägsta kravet på temperaturskillnad, ändras båda förinställda temperaturer automatiskt till tillåtet intervallområde.

Inställbart förinställt temperaturintervall

Funktionsläge	Förinställt temperaturintervall
Kyla/Torr	19 ~ 30°C (67 ~ 87°F)
Värme	17 ~ 28°C (63 ~ 83°F)
Auto (enkelt börvärde)	19 ~ 28°C (67 ~ 83°F)
Auto (dubbelt börvärde)	[Kyla] Förinställt temperaturintervall för läget "Kyla" [Värme] Förinställt temperaturintervall för läget "Värme"
Fläkt/Ventilation	Kan ej ställas in

Det inställningsbara temperaturintervallet är olika för olika inomhusenhetsmodeller.

Grundläggande funktioner

Fläkthastighet

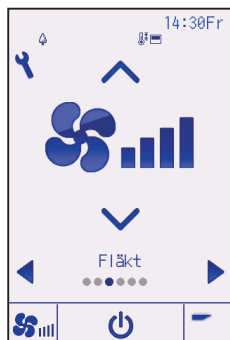

Varje gång du trycker på någon av knapparna ▼ och ▲ bläddras de följande fläkthastigheterna igenom.

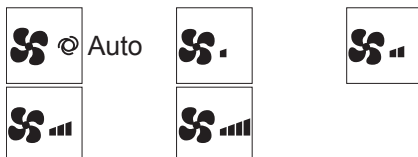

- De tillgängliga fläkthastigheterna beror på modell på anslutna inomhusenheter.

Inställning av fläktblad



(Exempel avseende CITY MULTI)

Varje gång du trycker på någon av knapparna ▼ och ▲ bläddras de följande bladinställningarna igenom. Välj önskad inställning.

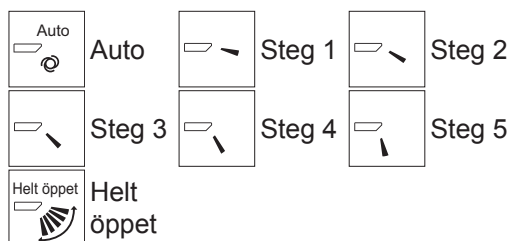

Välj "Helt öppet" för att flytta fläktbladen upp och ner automatiskt.

När inställningen är "Steg 1" till "Steg 5" kommer fläktbladet att ställas in i önskad vinkel.

- **1h** till vänster om symbolen för inställning för blad Denna symbol kommer att visas när bladet är inställt på Steg 2, 3, 4 eller 5 och fläkten arbetar i låg hastighet vid kylning eller torkning (beroende på modell). Symbolen kommer släckas om en timme och fläktbladets inställning kommer automatiskt att ändras.

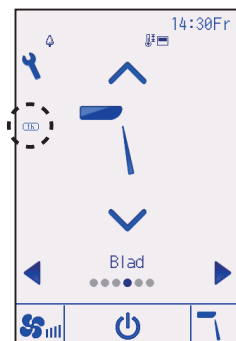

Inställning av spjäll

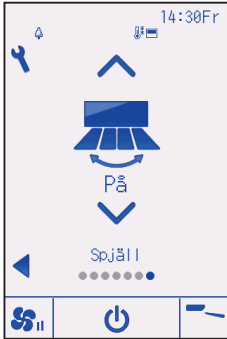

Tryck på någon av knapparna ▼ eller ▲ för att slå på eller stänga av spjällrörelsen.



(Exempel avseende CITY MULTI)

Inställning av ventilation

Inställningen av ventilation kan göras även när enheterna är i drift.

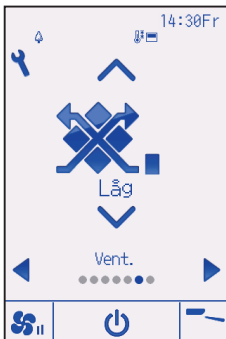

Varje gång du trycker på någon av knapparna ▼ och ▲ bläddras de följande ventilationsinställningarna igenom.

* Kan bara ställas in när Lossnay-enheten är ansluten.



• Fläkten på vissa modeller av inomhusenheter kan synkroniseras med vissa ventilationsenheter.

(Exempel avseende Mr. SLIM)

Navigera genom menyn

Huvudmeny

Huvudmeny	Inställning		Funktion	Sida
Användning	Hög effekt		Använd för att snabbt uppnå en behaglig rumstemperatur. • Enheter kan användas i högt effektläge i upp till 30 minuter.	25
	Komfort	Manuell fläktbladsvinkel	Använd för att ställa in varje fläktblads vinkel.	26
Timer	Timer	På/Av timer	Tryck för att sätta På/Av timer. • Tiden kan ställas in i steg om 5 minuter. * Klockinställning krävs.	29
		Auto-Av-timer	Använd för att ställa in automatisk tid för avstängning. • Tiden kan ställas in från 30 till 240 minuter i steg om 10 minuter.	32
	Veckotimer		Tryck för att ställa in tider för På/Av veckovis. • Upp till åtta program kan ställas in för varje dag. • Två typer av veckoscheman kan ställas in. * Klockinställning krävs. * Ej giltig när På/Av-timern är aktiverad. * Steg om 1°C	34
	Utomhusenhetens tyst läge		Använd för att ställa in tidsperioderna när tyst drift av utomhusenheter prioriteras före temperaturkontroll. Ställ in Start/Stopptider för varje veckodag. • Välj önskad tystnadsnivå, antingen "Norm," "Mellan," och "Tyst." * Klockinställning krävs.	37
	Nattemperatur		Använd för att ställa in nattemperatur. • Välj "Ja" för att aktivera inställningen och "Nej" för att inaktivera inställningen. Temperaturintervallet och start/stopp tider kan ställas in. * Klockinställning krävs. * Steg om 1°C	40
Energispar	Begränsning	Temperaturområde	Använd för att begränsa det förinställda temperaturintervallet. • Olika temperaturintervall kan ställas in för olika funktionslägen. * Steg om 1°C	43
		Funktionen låst	Använd för att låsa utvalda funktioner. • De låsta funktionerna kan inte användas.	46
	Energispar	Autoretur	Använd för att få enheterna att använda den förinställda temperaturen efter att ha varit i energisparläge under en viss tid. • Tiden kan ställas in från 30 och 120 minuter i steg om 10 minuter. * Denna funktion är inte tillgänglig när de förinställda temperaturintervallen är begränsade. * Steg om 1°C	49

Huvudmeny	Inställning		Funktion	Sida
Energispar	Energispar	Schema	Ställ in start/stopptider för att sätta enheterna i energisparläge för varje veckodag samt energisparnivån. <ul style="list-style-type: none"> • Upp till fyra energisparprogram kan ställas in för varje dag. • Tiden kan ställas in i steg om 5 minuter. • Energisparnivån kan ställas in från 0% och 50% till 90% i steg om 10%. * Klockinställning krävs.	51
Standardinställning	Grundläggande inställning	Klocka	Använd för att ställa in aktuell tid.	54
		Sommartid	Ställer in sommartid.	56
	Displayinställning	Primär display	Använd för att växla mellan "Högsta" och "Bas" för statusdisplayen och den primära displayen. <ul style="list-style-type: none"> • Standardinställningen är "Högsta." 	58
		Ljusstyrka	Använd för att justera skärmens ljusstyrka.	61
		Språkval	Använd för att välja önskat språk.	62
		Utformning	Används för att ändra statusdisplayens och den primära displayens färg.	64
	Pekskärmspanel	Kalibrering av pekskärmen	Anger kalibreringsinställningarna för pekskrmspanelen.	66
		Pekskärmrengöring	Gör pekskrmspanelen tillfälligt okänslig för beröringar så att den kan rengöras.	68
Service	Återställ fjärrkontrollen	Använd för att återställa fjärrkontrollen till fabriksinställningen.	70	
	Fjärrkontrollsinformation	Använd för att visa fjärrkontrollens modellnamn, programvaruversion och serienummer.	72	
Underhåll	Felinformation	Använd för att kontrollera felinformation när ett fel inträffar. <ul style="list-style-type: none"> • Felkod, felkälla, kylmedelsadress, enhetsmodell, tillverkningsnummer, kontaktinformation (återförsäljarens telefonnummer) kan visas. * Enhetsmodellen, tillverkningsnummer och kontaktinformation måste registreras i förväg för att visas.	74	
	Filterinformation	Använd för att kontrollera filterstatus. <ul style="list-style-type: none"> • Filtertecknet kan återställas. 	78	

Navigera genom menyn

Navigera genom Huvudmenyn

Använda knappar

Åtkomst till Huvudmenyn



Tryck på knappen **Inställning** på den primära displayen.

Huvudmenyn visas.

Välja



Tryck på **F2** för att flytta markören åt vänster.

Tryck på **F3** för att flytta markören åt höger.

Markör

Funktionsinställningar

Hög effekt



Funktionsbeskrivning

Funktionen hög effekt låter enheten fungera med högre en normal kapacitet, så att luften i rummet snabbt kan uppnå optimal temperatur. Den varar i upp till 30 minuter och enheten kommer att återgå till normalt funktionsläge när de 30 minuterna har gått eller rumstemperaturen når förinställd temperatur, beroende på vad som inträffar först. Enheten kommer att återgå till normalt funktionsläge när funktionsläge eller fläkthastighet ändras.

Använda knappar

1



Välj "Hög effekt" i menyn Användning vid kyla, värme eller Auto och tryck sedan på knappen **VÄLJ**.

Funktionen "Hög effekt" är bara tillgänglig på modeller som stödjer den funktionen.

2



Flytta markören till "Ja" med någon av knapparna **F3** och **F4** och tryck sedan på knappen **VÄLJ**.

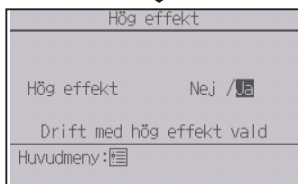

En bekräftelse kommer att visas.

Navigera mellan menyerna

- Återgå till Huvudmenyn med knappen **MENY**
- Återgå till föregående skärm med knappen **TILLBAKA**

Funktionsinställningar

Manuell fläktbladsvinkel

OFF

Använda knappar

1



Välj "Komfort" i menyn Användning och tryck på knappen **VÄLJ**.

2

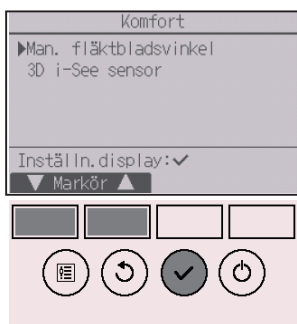

Välj "Man. fläktbladsvinkel" med någon av knapparna **F1** och **F2** och tryck på knappen **VÄLJ**.

3



Flytta markören till "Ref.adress" eller "Enhet nr" med knappen **F1** för att välja.

Välj kylmedelsadressen och enhetsnumret för enheterna vars fläktblad ska ställas in med någon av knapparna **F2** och **F3** och tryck på knappen **VÄLJ**.

- Ref. adress: Kylmedelsadress
- Enhet nr: 1, 2, 3, 4

Tryck på knappen **F4** för att bekräfta enheten.

Bilden till vänster visar hur en display kan se ut på en Mr. SLIM. På CITY MULTI-enheter visas "M-NET-adress" i stället för "Ref.adress" och "Enhet nr" visas inte.

4



Välj "Blad" med knappen **F1**.

Välj "4-vägs" eller "2-vägs" med någon av knapparna **F2** och **F3** och tryck på knappen **F4**.

Funktionsinställningar

5

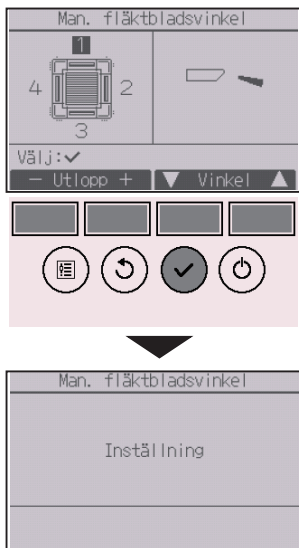

Aktuell inställning på fläktbladen visas.

Välj önskade utlopp bland "1", "2", "3", "4" eller "1, 2, 3, 4 (alla utlopp)" med någon av knapparna **[F1]** och **[F2]**.

Tryck på någon av knapparna **[F3]** och **[F4]** för att gå igenom följande alternativ och välj önskad inställning.

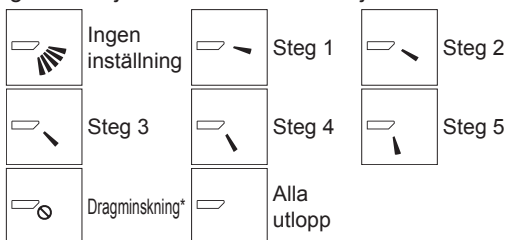

Tryck på knappen **[VÄLJ]** för att spara inställningarna. En skärm visas som anger att inställningsinformationen överförs.

Ändringarna kommer att göras av det valda utloppet. Skärmen kommer automatiskt att återgå till föregående skärm när överföringen är avslutad. Gör inställningar för andra utlopp genom att följa samma procedur.

Om alla utlopp är valda kommer  att visas nästa gång enheten sätter igång.

Navigera mellan menyerna

• Återgå till föregående skärm med knappen **[TILLBAKA]**

*Dragminskning

Läget [Dragminskning] håller bladets vinkel mer horisontell än vinkeln för Steg 1 så att luftflödet inte kommer att riktas direkt mot människor.

Denna funktion kan endast ställas in för ett uttag.

Denna funktion kan inte ställas in för modeller med två eller tre uttag.

I läget Dragminskning kan luftflödet orsaka missfärgning av taket.

Timer (På/Av-timer)



Använda knappar

1

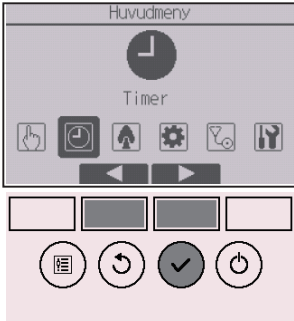

Välj "Timer" på Huvudmenyn (se sidan 24) och tryck sedan på knappen **VÄLJ**.

På/Av-timern kommer inte att fungera i följande fall:

när Av/På-timer är inaktiverad, vid ett fel, vid kontroll (i servicemenyn), vid testkörning, vid diagnos av fjärrkontroll, när klockan inte är inställd, vid funktionsinställning, när systemet är centralstyrt (när användning av "På/Av" eller timeranvändning med den lokala fjärrkontrollen är förbjuden).

2



Flytta markören till "Timer" och tryck sedan på knappen **VÄLJ**.

3

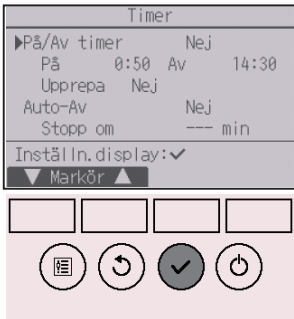

Aktuell inställning visas.

Flytta markören till "På/Av-timer" och tryck sedan på knappen **VÄLJ**.

Funktionsinställningar

4



Menyn för att ställa in timern visas.

Välj, med någon av knapparna **F1** och **F2**, önskat val bland "Av/På-timer", "På", "Av", och "Upprepa".

5



Ändra inställningen med någon av knapparna **F3** och **F4**.

- På/Av-timer: Nej (inaktivera)/Ja (aktivera)
- På: Starttid
(kan ställas in i steg om 5 minuter)
* Tryck ner och håll knappen nertryckt för att ändra siffrorna snabbt.
- Av: Stopptid
(kan ställas in i steg om 5 minuter)
* Tryck ner och håll knappen nertryckt för att ändra siffrorna snabbt.
- Upprepa: Nej (en gång)/Ja (upprepa)

6



Tryck på knappen **VÄLJ** för att spara inställningarna.





En bekräftelse kommer att visas.

Navigera mellan menyerna

- Återgå till Huvudmenyn med knappen **MENY**
- Återgå till föregående skärm med knappen **TILLBAKA**



 kommer att visas på statusdisplayen och den primära displayen i högsta läget när På/Av-timer är aktiverad.

 visas när timern avaktiveras via det centrala styrsystemet.

Funktionsinställningar

Timer (Auto-Av-timer)



Använda knappar

1



Visar menyn för inställning av Timer.
(Se sidan 29.)

Välj "Auto-Av" och tryck på knappen **VÄLJ**.

Auto-Av-timern kommer inte att fungera i följande fall:

när Auto-Av-timer är inaktiverad, vid ett fel, vid kontroll (i servicemenyn), vid testkörning, vid diagnos av fjärrkontroll, vid funktionsinställning, när systemet är centralstyrt (när användning av "På/Av" eller timeranvändning med den lokala kontrollen är förbjuden).

2



Aktuell inställning visas.

Flytta markören till "Auto-Av" eller "Stopp om --- min" med någon av knapparna **F1** och **F2**.

3



Ändra inställningen med någon av knapparna **F3** och **F4**.

- Auto-Av: Nej (inaktivera)/Ja (aktivera)
- Stopp om --- min: Inställning av timer (Intervallet som är möjligt att ställa in är 30 till 240 minuter i steg om 10 minuter).

4



Tryck på knappen [VÄLJ] för att spara inställningarna.

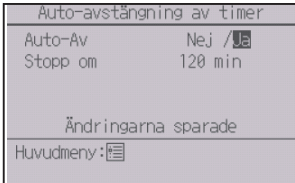



En bekräftelse kommer att visas.

Navigera mellan menyerna

- Återgå till Huvudmenyn med knappen [MENY]
- Återgå till föregående skärm med knappen [TILLBAKA]



 kommer att visas på statusdisplayen och den primära displayen i högsta läget när Auto-Av-timern är aktiverad.

 visas när timern avaktiveras via det centrala styrsystemet.

Funktionsinställningar

Veckotimer



Använda knappar

1



Välj "Veckotimer" på menyn Timer och tryck på knappen **VÄLJ**.

Veckotimern kommer inte att fungera i följande fall: när Av/På-timer är inaktiverad, när veckotimern är inaktiverad, vid ett fel, vid kontroll (i servicemenyn), vid testkörning, vid diagnos av fjärrkontroll, när klockan inte är inställd, vid funktionsinställning, när systemet är centralstyrt (användningen "På/Av", inställning av temperatur, eller timeranvändning med den lokala fjärrkontrollen är förbjuden).

2



Aktuell inställning visas.

Tryck på någon av knapparna **F1** och **F2** för att se inställningarna för varje veckodag.

Tryck på knappen **F3** för att se program 5 till 8.

Tryck på knappen **F4** för att visa status för Inställning 2.

Tryck på knappen **VÄLJ** för att gå till skärmen för inställning.

3



Det kommer fram en skärm för att ställa in veckotimern.

I inställningen "Åtgärd" väljer du "1" för att aktivera timerinställningen 1, eller "2" för att aktivera timerinställningen 2, med någon av knapparna **F3** och **F4**. Tryck sedan på knappen **VÄLJ**.

För att kontrollera inställningsinnehållet i timerinställningen 1 eller 2, flytta markören till "Inställning" med någon av knapparna **F1** och **F2**, och väljer "1" eller "2" med någon av knapparna **F3** och **F4**.

4



Menyn för att ställa in veckotimer visas och aktuella inställningar kommer att visas.

Upp till åtta program kan ställas in för varje dag. Flytta markören till önskad veckodag med någon av knapparna **F1** eller **F2** och tryck sedan på knappen **F3** för att välja. (Flera dagar kan väljas).

Tryck på knappen **VÄLJ**.

Funktionsinställningar

5

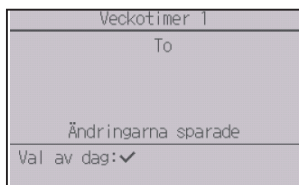

Menyn för inställning av program visas.

Tryck på knappen **[F1]** för att flytta markören till önskat programnummer.

Flytta markören till tiden, På/Av eller temperatur med knappen **[F2]**.

Ändra inställningarna med någon av knapparna **[F3]** och **[F4]**.

- Tid: kan ställas in i steg om 5 minuter
 - * Tryck ner och håll knappen nertryckt för att ändra siffrorna snabbt.
- På/Av/Auto: Möjliga inställningar beror på modellen av den anslutna inomhusenheten. (När ett "Auto"-mönster körs, kommer systemet att arbeta i läge "Auto" (dubbelt börvärde)).
- Temperatur: Temperaturområdet som kan ställas in beror på de anslutna inomhusenheterna. (i steg om 1°C) När läge "Auto" (dubbelt börvärde) är valt, kan två förinställda temperaturer ställas in. Om ett användningsmönster med en enda förinställd temperaturinställning utförs under läge "Auto" (dubbelt börvärde), används denna inställning som kyltemperaturinställning i läge "Kyla".

Tryck på knappen **[VÄLJ]** för att spara inställningarna. En bekräftelse kommer att visas.

Navigera mellan menyerna

- Återgå till inställningarna för val av vecka med knappen **[VÄLJ]**
- Återgå till Huvudmenyn med knappen **[MENY]**
- Återgå till föregående skärm med knappen **[TILLBAKA]**



[?] kommer att visas på statusdisplayen och den primära displayen i högsta läget när veckotimern har en inställning för aktuell dag.

Symbolen visas inte när På/Av-timern är aktiverad, eller om systemet är under central styrning (användning av "Timer" med den lokala fjärrkontroller är förbjudet).

Funktionsbeskrivning

Denna funktion låter användaren ställa in tidsperioderna när tyst drift av utomhusenheter prioriteras före temperaturkontroll. Ställ in start- och stopptider för varje veckodag för tyst drift. Välj önskad tystnadsnivå, antingen "Mellan" eller "Tyst".

Använda knappar

1



Välj "OU tyst läge" på menyn Timer och tryck på knappen **VÄLJ**.

Funktionen "OU tyst läge" är bara tillgänglig på modeller som stödjer den funktionen.

2



Aktuell inställning visas.

Tryck på någon av knapparna **F1** och **F2** för att se inställningarna för varje veckodag.

Tryck på knappen **VÄLJ** för att gå till skärmen för inställning.

Funktionsinställningar

3



Menyn för att aktivera (Ja) och inaktivera (Nej) tyst läge visas.

Aktivera genom att flytta markören till "Ja" med någon av knapparna **F3** och **F4** och tryck sedan på knappen **VÄLJ**.

4



Menyn för inställning av utomhusenhetens tyst läge visas.

Ändra denna inställning genom att flytta markören till önskad veckodag med någon av knapparna **F1** och **F2** och tryck sedan på knappen **F3** för att välja den. (Flera dagar kan väljas).

Tryck på knappen **VÄLJ**.

5

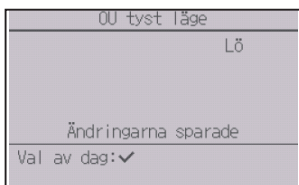

Menyn för inställning visas.

Flytta markören till önskat val med någon av knapparna [F1] och [F2], välj mellan starttid, stopptid och tyst nivå.

Ändra inställningarna med någon av knapparna [F3] och [F4].

- Start-/stopptid: kan ställas in i steg om 5 minuter
 - * Tryck ner och håll knappen nertryckt för att ändra siffrorna snabbt.
- Tyst nivå: Normal, Mellan, Tyst



Normal



Mellan



Tyst

Tryck på knappen [VÄLJ] för att spara inställningarna. En bekräftelse kommer att visas.

Navigera mellan menyerna

- Återgå till inställningarna för val av vecka med knappen [VALJ]
- Återgå till Huvudmenyn med knappen [MENY]
- Återgå till föregående skärm med knappen [TILLBAKA]



kommer att visas på statusdisplayen och den primära displayen i högsta läget under utomhusenhetens tyst läge.

Funktionsinställningar

Nattemperatur



Funktionsbeskrivning

Denna kontroll påbörjar uppvärmningen när dess objektgrupp stoppas och rumstemperaturen sjunker under den förinställda undre gränsen. Denna kontroll påbörjar avkylningen när dess objektgrupp stoppas och rumstemperaturen stiger över den förinställda övre gränsen.

Funktionen Nattemperatur är inte tillgänglig om funktionen och temperaturinställningen utförs från fjärrkontrollen.

Om rumstemperaturen mäts av luftkonditionerarens insugstemperatursensor kan inte den korrekta temperaturen erhållas när luftkonditioneraren är avstängd eller när luften inte är ren. Byt då ut sensorn till en fjärrsensor (PAC-SE40TSA/PAC-SE41TS-E) eller en fjärrkontrollsensor.

Använda knappar

1



Välj "Nattemperatur" på menyn Timer och tryck på knappen **VÄLJ**.

2



Aktuell inställning visas.

Tryck på knappen **VÄLJ** för att gå till skärmen för inställning.

3

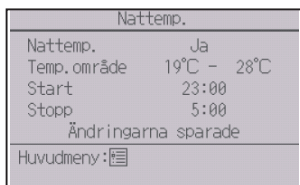

Flytta markören till önskat val med någon av knapparna **F1** och **F2**, välj mellan Nattemperatur Nej (inaktivera)/Ja (aktivera), Temperaturområde, Starttid och Stoptid.

Ändra inställningarna med någon av knapparna **F3** och **F4**.

- Temp.område: Den undre temperaturbegränsningen (för värme) och den övre temperaturbegränsningen (för kyla) kan ställas in. Temperaturskillnaden mellan den övre och den undre gränsen måste vara 4°C (8°F) eller mer. Temperaturområdet som kan ställas in beror på de anslutna inomhusenheterna.
 - * Steg om 1°C
- Start-/stoptid: kan ställas in i steg om 5 minuter
 - * Tryck ner och håll knappen nertryckt för att ändra siffrorna snabbt.

Tryck på knappen **VÄLJ** för att spara inställningarna. En bekräftelse kommer att visas.

Navigera mellan menyerna

- Återgå till Huvudmenyn med knappen **MENY**
- Återgå till föregående skärm med knappen **TILLBAKA**

Funktionsinställningar



⌚ kommer att visas på statusdisplayen och den primära displayen i högsta läget när funktionen Nattemperatur är aktiverad.

⌚ visas när timern avaktiveras via det centrala styrsystemet.

Nattemperatur kommer inte att fungera i följande fall:

när enheten används, när funktionen Nattemperatur är inaktiverad, vid ett fel, vid kontroll (i servicemenyn), vid testkörning, vid diagnos av fjärrkontroll, när klockan inte är inställd, vid funktionsinställning, när systemet är centralstyrt (användningen "På/Av", inställning av temperatur, eller timeranvändning med den lokala fjärrkontrollen är förbjuden).

Ställa in begränsning av temperaturområdet

Använda knappar

- 1 Välj "Energispar" på Huvudmenyn (se sidan 24) och tryck sedan på knappen **VÄLJ**.

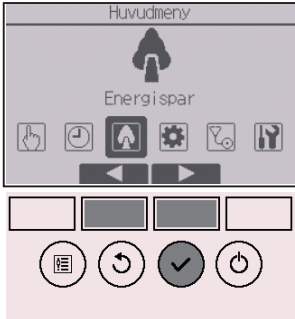

- 2 Flytta markören till "Begränsning" med någon av knapparna **F1** och **F2** och tryck sedan på knappen **VÄLJ**.



Funktionsinställningar

3



Aktuell inställning visas.

Flytta markören till "Temp.område" med någon av knapparna **F1** och **F2** och tryck sedan på knappen **VÄLJ**.

4



Menyn för att ställa in temperaturområdet visas.

Flytta med knappen **F1** markören till önskat val bland "Temp.område", "Kyla•Torr", "Värme" eller "Auto".

5

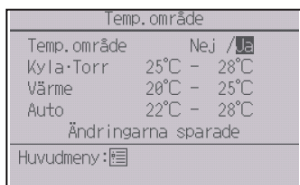

Ändra inställningarna med någon av knapparna [F3] och [F4].

- Temp.område: Nej (obegränsat) eller Ja (begränsat)
- Kyla•Torr: Övre och undre temperaturgräns (steg om 1°C)
- Värme: Övre och undre temperaturgräns (steg om 1°C)
- Auto: Övre och undre temperaturgräns (steg om 1°C)

Temperaturområde

Läge		Undre gräns	Övre gräns
Kyla•Torr	*1	19 ~ 30°C	30 ~ 19°C
	*3	(67 ~ 87°F)	(87 ~ 67°F)
Värme	*2	17 ~ 28°C	28 ~ 17°C
	*3	(63 ~ 83°F)	(83 ~ 63°F)
Auto	*4	19 ~ 28°C	28 ~ 19°C
		(67 ~ 83°F)	(83 ~ 67°F)

* Området som kan ställas in beror på den anslutna enheten.

*1 Temperaturområden för läge "Kyla", "Torr", och "Auto" (dubbelt börvärde) kan ställas in.

*2 Temperaturområden för läge "Värme" och "Auto" (dubbelt börvärde) kan ställas in.

*3 Temperaturområden för läge "Värme", "Kyla", och "Torr" måste uppfylla kraven nedan:

- Övre gräns för kylning - övre gräns för uppvärmning \geq lägsta temperaturskillnad (varierar med modellen på inomhusenheten)

- Nedre gräns för kylning - nedre gräns för uppvärmning \geq lägsta temperaturskillnad (varierar med modellen på inomhusenheten)

*4 Temperaturområden för läge "Auto" (enkelt börvärde) kan ställas in.

Tryck på knappen [VÄLJ] för att spara inställningarna. En bekräftelse kommer att visas.

Navigera mellan menyerna

- Återgå till Huvudmenyn med knappen [MENY]
- Återgå till föregående skärm med knappen [TILLBAKA]



 kommer att visas på statusdisplayen och den primära displayen i högsta läget när temperaturområdet är begränsat.

Funktionsinställningar

Begränsning

P

Låsa funktion

Aktivera funktionslåset genom att ställa in alternativet "Funktionen låst" till "Ja".

Använda knappar

1



Visar menyn för inställning av begränsning. (Se sidan 43.)

Flytta markören till "Funktionen låst" och tryck sedan på knappen **VÄLJ**.

2

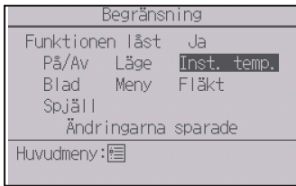

Menyn för att ställa in funktionslås visas.

Flytta markören, med någon av knapparna **[F1]** och **[F2]**, till önskat val bland "Funktionen låst", "Plats", "På/Av", "Läge", "Inst. temp.", "Meny", "Fläkt", "Spjäll" och "Blad".

Ändra inställningarna med någon av knapparna **[F3]** och **[F4]**.

- Funktionen låst: Nej (inaktivera)/Ja (aktivera)
- Plats: "Indiv." eller "Hotell"
- På/Av: På/Av
- Läge: Inställning av funktionsläge
- Inst. temp.: Förinställd temperaturinställning
- Blad: Bladinställning
- Meny: Menyinställning
- Fläkt: Inställning av fläkthastighet
- Spjäll: Inställning av spjäll

"-" / "Läst"

När "Hotell" väljs för inställningen "Plats" läses följande åtgärder automatiskt: Läge, Blad, Meny och Spjäll.

Tryck på knappen **[VÄLJ]** för att spara inställningarna. En bekräftelse kommer att visas.

Navigera mellan menyerna

- Återgå till Huvudmenyn medknappen **[MENY]**
- Återgå till föregående skärm medknappen **[TILLBAKA]**

Funktionsinställningar



 kommer att visas på statusdisplayen och den primära displayen i högsta läget när inställningen för funktionslås är aktiverad.

Guiden som motsvarar den låsta funktionen kommer att döljas.

Visa huvudmenyn medan menyinställningen är låst genom att trycka på och håll in knappen `[Inställning]` i minst tio sekunder. Ange administratörens lösenord på skärmen för lösenordsinmatning.

Automatisk retur till den förinställda temperaturen

Efter det att Autoretur funktionen är aktiverad när funktionsläge ändras eller drift PÅ/AV utförs från denna fjärrkontroll, kommer den inställda temperaturen automatiskt att återgå till föreskriven temperatur oavsett av inställd tid.

Använda knappar

1



Välj "Energispar" i Energisparmenyn och tryck på knappen **VÄLJ**.

2



Aktuell inställning visas.

Flytta markören till "Autoretur" med någon av knapparna **F1** och **F2** och tryck sedan på knappen **VÄLJ**.

Funktionsinställningar

3



Menyn för att ställa in automatisk retur till den förinställda temperaturen visas.

Flytta, med någon av knapparna **F1** och **F2**, markören till önskat val bland "Autoretur", "Kyla" eller "Värme".

4



Ändra inställningarna med någon av knapparna **F3** och **F4**.

- Autoretur: Nej (inaktivera)/Ja (aktivera)
- Kyla: Området för inställning av timern är 30 till 120 minuter i steg om 10 minuter. Området för att ställa in temperaturen är 19 till 30°C (67 to 87°F) (i steg om 1°C).
- Värme: Området för inställning av timern är 30 till 120 minuter i steg om 10 minuter. Området för att ställa in temperaturen är 17 till 28°C (63 to 83°F) (i steg om 1°C).

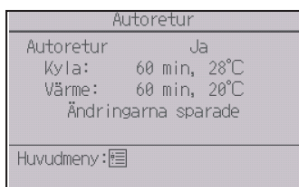

Tryck på knappen **VÄLJ** för att spara inställningarna. "Kyla" inkluderar "Torr" och "Auto Kyla" och "Värme" inkluderar "Auto Värme".

Menyn för valda inställningar visas.

Navigera mellan menyerna

- Återgå till Huvudmenyn med knappen **MENY**
- Återgå till föregående skärm med knappen **TILLBAKA**

Inställningarna för "Timer" eller förinställda temperaturer kommer inte att fungera när temperaturintervallet är begränsat och när systemet är centralstyrt (när inställning av temperaturintervall inte är tillåtet från en lokal kontroll). När systemet är centralstyrt (när användning av "Timer" med lokal fjärrkontroll inte är tillåtet), är endast inställningen av "Timer" ineffektiv.

Ställa in program för energisparläge

Använda knappar

1



Visar menyn för inställning av "Energispar". (Se sidan 49.)

Flytta markören till "Schema" och tryck sedan på knappen **VÄLJ**.

2



Menyn för att ställa in schemat visas.

Tryck på någon av knapparna **F1** och **F2** för att se inställningarna för varje veckodag.

Tryck på knappen **VÄLJ** för att gå till skärmen för inställning.

3



Menyn för att aktivera (Ja)/inaktivera (nej) energisparschemat visas.

Välj "Nej" eller "Ja" med någon av knapparna **F3** och **F4**.

Tryck på knappen **VÄLJ** för att gå till inställningarna för val av veckodag.

Funktionsinställningar

4



Menyn för inställning av val av veckodag visas. Upp till fyra program kan ställas in för varje dag. Flytta markören till önskad veckodag med någon av knapparna **F1** eller **F2** och tryck sedan på knappen **F3** för att välja. (Flera dagar kan väljas). Tryck på knappen **VÄLJ** för att gå till meny för inställning av programmet.

5



Menyn för programinställning visas. Tryck på knappen **F1** för att flytta markören till önskat programnummer. Flytta, med knappen **F2**, markören till önskat val bland starttid, stopptid och energisparnivån (ordnat i denna ordning från vänster)

Ändra inställningarna med någon av knapparna **F3** och **F4**.

- Start-/stopptid: kan ställas in i steg om 5 minuter
- * Tryck ner och håll knappen nertryckt för att ändra siffrorna snabbt.
- Energisparnivån: Inställningsområdet är 0% och 50 till 90% i steg om 10%.

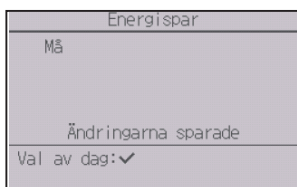

Tryck på knappen **VÄLJ** för att spara inställningarna. En bekräftelse kommer att visas.

Ju lägre värde, desto högre effekt för energisparandet.



 kommer att visas på statusdisplayen och den primära displayen i högsta läget när energisparfunktionen är aktiverad.

Navigera mellan menyerna

- Återgå till inställningarna för val av vecka med knappen **VALJ**
- Återgå till Huvudmenyn med knappen **MENY**
- Återgå till föregående skärm med knappen **TILLBAKA**

Funktionsinställningar

Klocka



Använda knappar

1

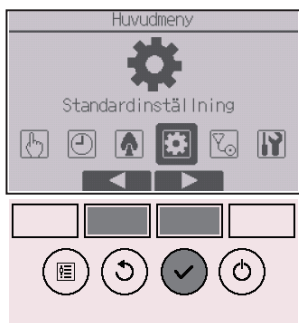

Välj "Standardinställning" på huvudmenyn (se sidan 24) och tryck sedan på knappen **VÄLJ**.

Klockan måste ställas in innan följande inställningar görs.

- På/Av timer
- Veckotimer
- Utomhusenhetens tyst läge
- Energispar
- Nattemperatur

Om ett system inte har några systemkontroller kommer inte tiden att korrigeras automatiskt. I så fall får du periodvis korrigera tiden.

2



Flytta markören till "Grundläggande inställning" med någon av knapparna **F1** och **F2** och tryck sedan på knappen **VÄLJ**.

3



Välj "Klocka" med någon av knapparna **F1** och **F2** och tryck på knappen **VÄLJ**.

4



Flytta markören till "Klocka" med någon av knapparna **F1** och **F2** och tryck sedan på knappen **VÄLJ**.

5



Flytta, med någon av knapparna **F1** och **F2**, markören till önskat val bland år, månad, datum, timme och minut.

Öka eller minska värdet med någon av knapparna **F3** och **F4** och tryck sedan på knappen **VÄLJ**.

En bekräftelse kommer att visas.

Navigera mellan menyerna

- Återgå till Huvudmenyn med knappen **MENY**
- Återgå till föregående skärm med knappen **TILLBAKA**

Funktionsinställningar

Sommartid



Funktionsbeskrivning

Start-/stopptiden för sommartid kan ställas in. Sommartidsfunktionen aktiveras baserat på inställningsinnehållet.

- Om ett system har en systemkontroll inaktiverar du denna inställning för att behålla den korrekta tiden.
- I början och i slutet av sommartiden kanske timern aktiveras två gånger eller inte alls.
- Denna funktion fungerar inte om inte klockan ställts in.

Använda knappar

1



Välj "Klocka" i menyn Grundläggande inställning och tryck på knappen **VÄLJ**.

2

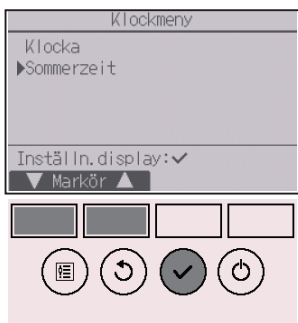

Flytta markören till "Sommartid" med någon av knapparna **F1** och **F2** och tryck sedan på knappen **VÄLJ**.

3

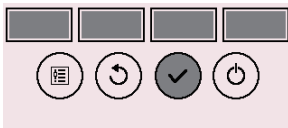

Flytta markören till följande val med knappen **[F1]** för att göra inställningarna.

- **Sommartid**
Välj "Nej" (inaktivera) eller "Ja" (aktivera) med knappen **[F2]**. Standardinställningen är "Nej".
 - **Datum(start)*1**
Ställ in veckodagen, veckonumret, och månaden med någon av knapparna **[F3]** och **[F4]**. Standardinställningen är "Sö/5:e/Mar".
 - **Starttid**
Ställ in starttiden för sommartiden med någon av knapparna **[F3]** och **[F4]**.
 - **Framåt till**
Ställ in tiden då klockan ska ställas om framåt till starttiden ovan med någon av knapparna **[F3]** och **[F4]**.
 - **Datum(stopp)*1 (2:a sidan)**
Ställ in veckodagen, veckonumret, och månaden med någon av knapparna **[F3]** och **[F4]**. Standardinställningen är "Sö/5:e/Okt".
 - **Stoptid (2:a sidan)**
Ställ in stopptiden för sommartiden med någon av knapparna **[F3]** och **[F4]**.
 - **Åter till (2:a sidan)**
Ställ in tiden då klockan ska ställas om bakåt till stopptiden ovan med någon av knapparna **[F3]** och **[F4]**.
- *1 Om "5:e" är valt för veckonumret, och den 5:e veckan inte finns under den valda månaden under året, betraktas inställningen som "4:e".

Tryck på knappen **[VÄLJ]** för att spara inställningarna. En bekräftelse kommer att visas.

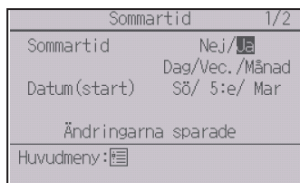

Navigera mellan menyerna

- Återgå till Huvudmenyn med knappen **[MENY]**
- Återgå till föregående skärm med knappen **[TILLBAKA]**

Funktionsinställningar

Primär display



Använda knappar

1



Välj "Displayinställning" i Inställningsmenyn och tryck på knappen **VÄLJ**.

2



Flytta markören till "Primär display" med någon av knapparna **F1** och **F2** och tryck sedan på knappen **VÄLJ**.

3



Välj "Högsta" eller "Bas" på huvudmenyn (se sidan 10) med någon av knapparna **F3** och **F4** och tryck sedan på knappen **VÄLJ**.

En bekräftelse kommer att visas.

Navigera mellan menyerna

- Återgå till Huvudmenyn med knappen **MENY**
- Återgå till föregående skärm med knappen **TILLBAKA**

Använda knappar

1

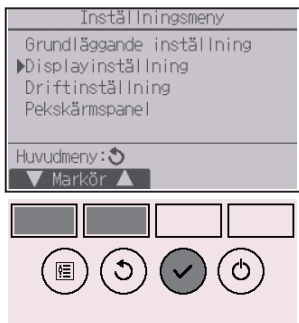

Välj "Displayinställning" i Inställningsmenyn och tryck på knappen [VÄLJ].

2



Flytta markören till "Inst. Primär display" med någon av knapparna [F1] och [F2] och tryck sedan på knappen [VÄLJ].

3



Välj "Ikonförklaring" med någon av knapparna [F1] och [F2], välj önskad inställning, d.v.s. "Ja" eller "Nej", med någon av knapparna [F3] och [F4] och tryck på knappen [VÄLJ].

Standardinställningen är "Ja".

Navigera mellan menyerna

- Återgå till Huvudmenyn med knappen [MENY]
- Återgå till föregående skärm med knappen [TILLBAKA]

Funktionsinställningar

4

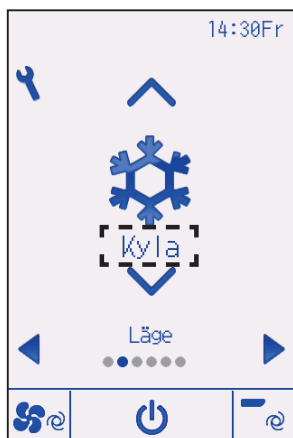

När "Ja" har valts visas förklaringen av inställningens symbol såsom till vänster.

Använda knappar

1



Välj "Displayinställning" i Inställningsmenyn och tryck på knappen **VÄLJ**.

2



Flytta markören till "Ljusstyrka" med någon av knapparna **F1** och **F2** och tryck sedan på knappen **VÄLJ**.

3



Justera ljusstyrkan med någon av knapparna **F1** och **F2**.

"PÅ" eller "AV" kan väljas för inställningen "Ha tänd" med knappen **F4**.

När "PÅ" väljs lyser bakgrundsljuset svagt även efter att angiven tid har gått ut.

Navigera mellan menyerna

- Återgå till Huvudmenyn med knappen **MENY**
- Återgå till föregående skärm med knappen **TILLBAKA**

Funktionsinställningar

Språkval



Funktionsbeskrivning

Önskat språk kan ställas in. Språkalternativen är engelska, franska, tyska, spanska, italienska, portugisiska, svenska, ryska, grekiska, turkiska, holländska, tjeckiska, ungerska och polska.

Använda knappar

1

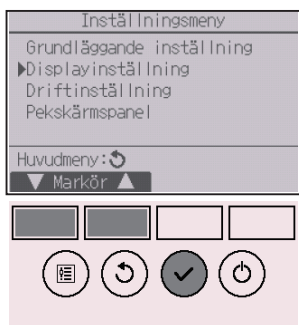

Välj "Displayinställning" i Inställningsmenyn och tryck på knappen **VÄLJ**.

2



Flytta markören till "Språkval" med någon av knapparna **F1** och **F2** och tryck sedan på knappen **VÄLJ**.

3

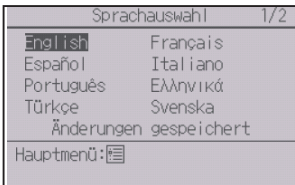

Flytta markören till önskat språk, med någon av knapparna **F1** till **F4**, och tryck sedan på knappen **VALJ** för att spara inställningen.

När strömmen sätts på första gången kommer skärmen för språkval att visas. Välj önskat språk. Systemet startar inte om inget språk väljs.

En skärm visas som anger att inställningen har sparats.

Navigera mellan menyerna

- Återgå till Huvudmenyn med knappen **MENY**
- Återgå till föregående skärm med knappen **TILLBAKA**

Funktionsinställningar

Utformning



Använda knappar

1



Välj "Displayinställning" i Inställningsmenyn och tryck på knappen **VÄLJ**.

2



Flytta markören till "Utformning" med någon av knapparna **F1** och **F2** och tryck sedan på knappen **VÄLJ**.

3



Välj "Färg" med knappen **F4**.

- Färg: Skärmfärgen kan väljas. (Se nästa sida.)
- Vit: Monokrom display (vit bakgrund)
- Svart: Monokrom display (svart bakgrund)

Tryck på knappen **VÄLJ** när "Vit" eller "Svart" har valts. När "Färg" har valts genom att välja önskad färg (se nästa sida).

4

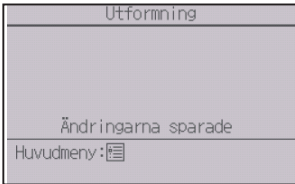

Välj följande punkt med någon av knapparna **[F1]** och **[F2]**, och ställ in önskad displayfärg för varje punkt.

- Färgnyans: Välj färgnyans med någon av knapparna **[F3]** och **[F4]**. (Det inställbara intervallet är -90 till 89.)
- Mönster: Välj färg med knappen **[F4]**.
- Färg inställd: Välj "Tecken" eller "Bakgrund" som målet där färgen ska tillämpas med knappen **[F4]**.

Färgprovet under funktionsknapparna ändras beroende på inställningen.

Ange önskad färg och tryck på knappen **[VÄLJ]**.

Navigera mellan menyerna

- Återgå till Huvudmenyn med knappen **[MENY]**
- Återgå till föregående skärm med knappen **[TILLBAKA]**

Funktionsinställningar

Kalibrering av pekskärmen



Använda knappar

1



Välj "Pekskärmspanel" i Inställningsmenyn och tryck på knappen **VÄLJ**.

2



Flytta markören till "Kalibrering av pekskärmen" med någon av knapparna **F1** och **F2** och tryck sedan på knappen **VÄLJ**.

3

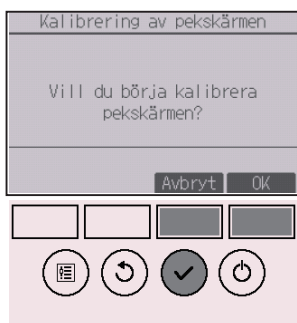

En bekräftelse kommer att visas.

Välj "Avbryt" eller "OK" med någon av knapparna **F3** och **F4** och tryck på knappen **VÄLJ**.

4

Peka på de svarta prickarna i den ordning som de dyker upp på skärmen. Det kommer att visas totalt nio stycken.

Peka på de svarta prickarna med en pekpena om en minut. Börja i det övre vänstra hörnet.

Peka på de nio svarta prickarna i den ordning som de visas på skärmen.

När alla nio svarta prickar har vidrörts är kalibreringen klar, och displayen återgår till att visa pekskärmsmenyn.

- Om pekskärmspanelen lämnas orörd i en minut avbryts kalibreringen och displayen återgår automatiskt till föregående skärm.
- För att korrekt kalibrera pekskärmspanelen ska du peka på prickarna med ett spetsigt, men inte vasst, föremål.
 - * Ett vasst föremål kan skada eller repa pekskärmspanelen.

Funktionsinställningar

Pekskärmrengöring



Använda knappar

1



Välj "Pekskärmspanel" i Inställningsmenyn och tryck på knappen **VÄLJ**.

2



Flytta markören till "Pekskärmrengöring" med någon av knapparna **F1** och **F2** och tryck sedan på knappen **VÄLJ**.

3

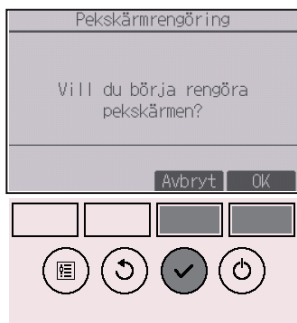

En bekräftelse kommer att visas.

Välj "Avbryt" eller "OK" med någon av knapparna **F3** och **F4** och tryck på knappen **VÄLJ**.

4



Med den här skärmen kan användaren torka av pekskärmspanelen i 30 sekunder utan att oavsiktligt ändra inställningarna.

Displayen visar pekskärmsmenyn igen efter dessa 30 sekunder.

- Torka av med en torr, mjuk trasa, en trasa indränkt i vatten med mildt tvättmedel, eller en trasa fuktad med etanol. Använd inte sura, alkaliska eller organiska lösningsmedel.

Funktionsinställningar

Återställ fjärrkontrollen



Funktionsbeskrivning

Fjärrkontrollen kan återställas till fabriksinställningen. Notera att följande data kommer att återställas. Fjärrkontrollen startas automatiskt efter återställningen.

Inställning av Timer, inställning av Veckotimer, inställning av Utomhusenhetens tyst läge, inställning av Energispar, inställning av Energisparalternativ, inställning av Klocka, inställning av Sommartid, inställning av Primär display, inställning av Ljusstyrka, inställning av Displayinformation, inställning av Utformning, inställning av Autoläge, inställning av Modellnamn, inställning av Serienummer, inställning av Återförsäljarinformation, Felinformation, Administratörslösenord, Underhållslösenord

Använda knappar

1



Välj "Övrigt" i menyn Service och tryck på knappen **VÄLJ**.

2



Flytta markören till "Återst. fjärrkontrollen" med någon av knapparna **F1** och **F2** och tryck sedan på knappen **VÄLJ**.

3



Välj "OK" med knappen **F4**.

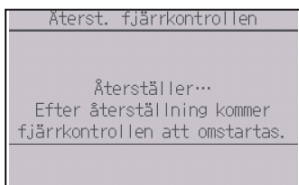

Fjärrkontrollen startas automatiskt efter återställningen.

Funktionsinställningar

Fjärrkontrollsinformation



Funktionsbeskrivning

Information om fjärrkontrollen som används kan kontrolleras.

Använda knappar

1

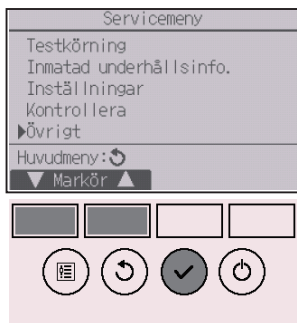

Välj "Övrigt" i menyn Service och tryck på knappen **VÅLJ**.

2



Flytta markören till "Fjärrkontrollinformation" med någon av knapparna **F1** och **F2** och tryck sedan på knappen **VÅLJ**.

3

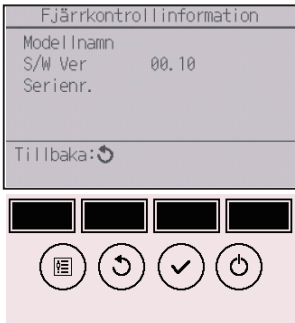

Modellnamn, programvaruversion och serienummer för den fjärrkontroll som används kan kontrolleras.

Felsökning

Felinformation

När ett fel inträffar visas följande skärm och drifts-LED blinkar. Kontrollera felstatus, stoppa driften och kontakta din återförsäljare.

Använda knappar

1



Felkod, felenhet, kylmedelsadress, enhetsmodell, datum och tidpunkt då ett fel inträffade och serienummer visas.

Modellnamn och serienummer visas endast om informationen har registrerats.

Tryck på någon av knapparna **F1** och **F2** för att gå till nästa sida.



Kontaktinformation (återförsäljarens telefonnummer) visas om informationen har registrerats.

2



Tryck på någon av knapparna **[F4]** och **[PÅ/AV]** för att återställa det inträffade felet.

Fel kan inte återställas när PÅ/AV inte är tillåtet.



Välj "OK" med knappen **[F4]**.



En bekräftelse kommer att visas.

Navigera mellan menyerna

- Återgå till Huvudmenyn med knappen **[MENY]**

Felsökning

Kontrollera felinformationen

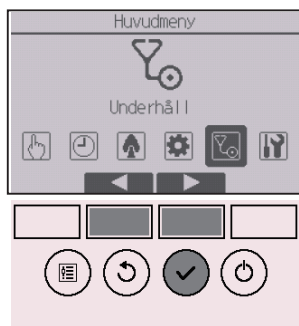

När inget fel inträffar kan sidan 2/2 av felinformationen (se sidan 74) visas från menyn Användning.

Välj "Underhållsmeny" på Huvudmenyn och tryck på knappen **VÅLJ**.

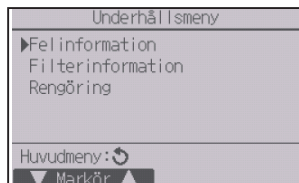

Visa felinformationsskärmen genom att välja "Felinformation" på Underhållsmenyn. Fel kan inte återställas.

Ingen upptagenhets-auto-av

Följande skärm kommer att visas för 3D i-See-sensorpanelmodellen när enheten stannas på grund av Ingen upptagenhets-auto-av funktionen för energisparalternativ.

Se instruktionsboken för inomhusenheten för 3D i-See-sensorinställningarna.

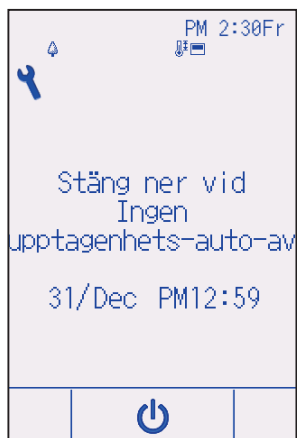

Underhåll

Filterinformation



 kommer visas på statusdisplayen och den primära displayen i högsta läget när det är dags att rengöra filtren.

Tvätta, rengör eller byt ut filtren när detta visas. Se instruktionshandboken för inomhusenheten.

Använda knappar

1

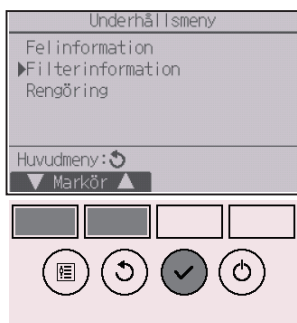

Välj "Filterinformation" på Underhålls meny och tryck på knappen **VÄLJ**.

2



Tryck på knappen **Å** för att återställa filtersymbolen. Se hur filtret rengörs i inomhusenhetens instruktionshandbok.

3



Välj "OK" med knappen **[F4]**.

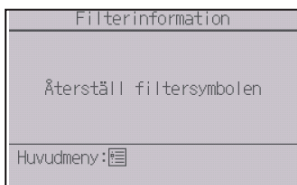

En bekräftelse kommer att visas.

Navigera mellan menyerna

- Återgå till Huvudmenyn med knappen **[MENY]**
- Återgå till föregående skärm med knappen **[TILLBAKA]**



När  visas på statusdisplayen och den primära displayen i högsta läget, är systemet centralstyrt och filtersymbolen kan inte återställas.

Om två eller fler inomhusenheter är anslutna kan tiden för filterrengöring vara olika för olika enheter, beroende på filtertyp.

Symbolen  visas när filtret på huvudenheten ska rengöras.

När filtersymbolen återställs, återställs den ackumulerade drifttiden för alla enheter.

Symbolen  ska visas efter en viss drifttid, under förutsättning att inomhusenheter är installerade i utrymmen med normal luftkvalitet. Beroende på luftkvaliteten, kan filtret behöva rengöras oftare.

Den ackumulerade tid då filtret behöver rengöras är modellberoende.

Specifikationer

Kontrollens specifikationer

	Specifikation
Produktens storlek	Standard (PAR-CT01MAA(R)-SB/PAR-CT01MAA-S): 65 (B) × 120 (H) × 14,1 (D) mm (2 9/16 × 4 23/32 × 9/16 [in]) (utom utstickande del)
	Premium (PAR-CT01MAA(R)-PB): 68 (B) × 120 (H) × 14,1 (D) mm (2 11/16 × 4 23/32 × 9/16 [in]) (utom utstickande del)
Nettovikt	Standard (PAR-CT01MAA(R)-SB/PAR-CT01MAA-S): 0,09 kg (13/64 lbs)
	Premium (PAR-CT01MAA(R)-PB): 0,10 kg (7/32 lbs)
Märkspänning	12 VDC (från inomhusenheter)
Energiförbrukning	0,6 W
Användningsmiljö	Temperatur 0 ~ 40°C (32 ~ 104°F) Fuktighet 25 ~ 90%RH (utan hänsyn till dagg)
Material	Standard (PAR-CT01MAA(R)-SB/PAR-CT01MAA-S) Hölje: ABS
	Premium (PAR-CT01MAA(R)-PB) Hölje: ABS Sidoplåt: Aluminium

Funktionslista (den 1 oktober 2017)

○ : Stöds × : Stöds ej

	Funktion	CITY MULTI	Mr. SLIM	Lösenord
Effekt	PÅ/AV	○	○	-
Inställningar	Funktionsläge	○	○	-
	Läget "Auto" (dubbelt börvärde)	○	○	-
	Förinställd temperatur	○	○	-
	Fläkthastighet	○	○	-
	Blad	○	○	-
	Spjäll	○	○	-
	Ventilation	○	○	-
Menyn Användning	Hög effekt	×	○	-
	Manuell fläktbladsvinkel	○	○	-
	3D i-See-sensor	○	○	-
Timermeny	Timer (På/Av-timer)	○	○	administratör
	Timer (Auto-Av-timer)	○	○	administratör
	Veckotimer	○	○	administratör
	Utomhusenhetens tyst läge	○	○	administratör
	Natttemperatur	○	○	administratör
Energisparmeny	Begränsning av temperaturområdet	○	○	administratör
	Låsa funktion	○	○	administratör
	Autoretur	○	○	administratör
	Schema	×	○	administratör
Inställningsmeny	Klocka	○	○	administratör
	Inställning av klockans visningsformat	○	○	administratör
	Sommartid	○	○	administratör
	Primär display	○	○	administratör
	Ikonförklaring	○	○	administratör
	Ljusstyrka	○	○	administratör
	Språkval	○	○	administratör
	Utförning	○	○	administratör
	Kalibrering av pekskärmen	○	○	administratör
	Pekskärmrengöring	○	○	administratör
Lösenord (administratör)	○	○	administratör	
Servicemeny	Återställ fjärrkontrollen	○	○	underhåll
	Fjärrkontrollsinformation	○	○	underhåll
	Testkörning	○	○	underhåll
	Inmatning av modellinformation	○	○	underhåll
	För in återförsäljarinfo	○	○	underhåll
	Inställning av funktion	○	○	underhåll
	Smidigt underhåll	×	○	underhåll
	Lösenord (Underhåll)	○	○	underhåll
Underhållsmeny	Automatiskt nedåtgående panel	○	○	-
	Felinformation	○	○	-
	Filterinformation	○	○	-

* Funktionerna som stöds varierar beroende på den anslutna enheten.

Specifikationer

Lista över funktioner som kan/inte kan användas tillsammans

	Hög effekt	På/Av timer	Auto-Av-timer	Veckotimer	Utomhusenhetens tyst läge	Temperaturområde	Funktionslås	Autoretur	Energispar-schema	Nattemperatur
Hög effekt		○	○	○	△1	○	△2	○	△1	○
På/Av timer	○		○	×1	○	○	○	○	○	△3
Auto-Av-timer	○	○		○	○	○	○	○	○	△4
Veckotimer	○	×1	○		○	○	○	○	○	△5
Utomhusenhetens tyst läge	△1	○	○	○		○	○	○	○	○
Temperaturområde	○	○	○	○	○		○	×2	○	△6
Funktionslås	△2	○	○	○	○	○		○	○	○
Autoretur	○	○	○	○	○	×2	○		○	△7
Energispar-schema	△1	○	○	○	○	○	○	○		○
Nattemperatur	○	△3	△4	△5	○	△6	○	△7	○	

○ : Kan användas tillsammans × : Kan inte användas tillsammans △ : Begränsat

△ 1: Denna funktion är aktiverad efter hög effektsdrift, eftersom den senare har högre prioritet.

△ 2: Denna funktion kan inte användas om en funktion är låst.

△ 3: Funktionen för nattemperatur kan inte användas när enheten är aktiverad genom På/Av-timerinställning.

△ 4: Auto-av-funktionen kan inte användas för nattemperatur.

△ 5: Funktionen för nattemperatur kan inte användas när enheten är aktiverad genom Veckotimerinställning.

△ 6: Inställning av temperaturområde kan inte användas för nattemperatur.

△ 7: Funktionen Autoretur kan inte användas för nattemperatur.

× 1: Inställning för veckotimer är inte användbar, eftersom På/Av-timer har högre prioritet.

× 2: Funktionen Autoretur kan inte användas eftersom inställningen för temperaturområde har högre prioritet.

Steuersystem CITY MULTI
und Mitsubishi-Klimageräte Mr. SLIM

MA Touch Fernsteuerung

PAR-CT01MAA-PB

PAR-CT01MAA-SB

PAR-CT01MAA-S

PAR-CT01MAR-PB

PAR-CT01MAR-SB

Anweisungshandbuch

Deutsch



Um eine korrekte Nutzung dieses Produktes zu gewährleisten, lesen Sie vor der Nutzung die Anweisungen in diesem Handbuch sorgfältig durch.

Für zukünftige Bezugnahme aufbewahren.

Diese CD-ROM und die Installationsanleitung müssen an zukünftige Benutzer weitergegeben werden.



Damit eine sichere und richtige Bedienung der Fernsteuerung gewährleistet ist, muss die Fernsteuerung von einem Fachmann eingebaut werden.

Inhaltsverzeichnis

Vorsichtsmaßnahmen	4
Steuerungskomponenten	6
Steuerungseinheit - Status-Display/Hauptdisplay	6
Steuerungseinheit - Menübildschirm	8
Display - Status-Display/Hauptdisplay	10
Menüstruktur und Symbole	12
Menüstruktur	12
Symbolbeschreibungen	15
Grundfunktionen	16
EIN/AUS-Schalter	16
Einstellungen für Betriebsrat, Temperatur, Lüfterdrehzahl, Vane, Louver und Ventilation (Lossnay)	17
Navigation durch das Menü	22
Hauptmenüliste	22
Navigation durch das Hauptmenü	24
Funktionseinstellungen	25
Hohe Leistung	25
Manueller Vane	26
Timer (Ein/Aus-Timer)	29
Timer (Ausschalt-Timer)	32
Wochentimer	34
Außengerät Leiselauff	37
Nachtabsenkung	40
Nicht zulässig	43
Energiesparbetrieb	49
Uhr	54
Sommerzeit	56
Hauptdisplay	58
Symbolbeschreibungen	59
Helligkeit	61
Sprachauswahl	62
Design	64
Touch-Panel-Kalibrierung	66
Touch-Panel-Reinigung	68
Fernbedienung zurücksetzen	70
Fernbedienungsinformation	72
Fehlerbehebung	74
Störungsinformation	74
Abschaltautomatik Keine Anwesenheit	77
Wartung	78
Filterinformationen	78
Technische Daten	80
Technische Daten Steuerung	80
Funktionsliste (Stand: 1. Oktober 2017)	81
Liste von Funktionen, die in Kombination genutzt/nicht genutzt werden können	82

Vorsichtsmaßnahmen

- Bevor die Anlage benutzt wird müssen die folgenden Vorsichtsmaßnahmen sorgfältig durchgelesen werden.
- Beachten Sie diese Maßnahmen zur Gewährleistung der Sicherheit gewissenhaft.

 WARNUNG	Weist auf die Gefahr einer tödlichen oder schweren Verletzung hin.
 VORSICHT	Weist auf die Gefahr einer schweren Verletzung oder struktureller Schäden hin.

- Übergeben Sie diese Anleitung nach dem Lesen dem Anwender, welcher sie zur zukünftigen Bezugnahme aufbewahren sollte.
- Bewahren Sie diese Anleitung zur zukünftigen Bezugnahme auf, und ziehen Sie im Zweifelsfall zurate. Diese Anleitung sollte den Personen, welche die Fernsteuerung reparieren oder neu installieren, zur Verfügung stehen. Stellen Sie sicher, dass die Anleitung an zukünftige Anwender weitergereicht wird.

Allgemeine Sicherheitshinweise

WARNUNG

Installieren Sie die Einheit nicht an einem Ort, an dem sie größeren Mengen an Öl, Dampf, organischen Lösungsmitteln, korrosiven Gasen wie schwefelhaltigen Gasen ausgesetzt ist oder an dem häufig saure/alkalische Lösungen oder Sprays verwendet werden. Diese Substanzen können die Leistung des Geräts beeinträchtigen, oder bestimmte Komponenten des Geräts können korrodieren. Dies kann zu Stromschlägen, Fehlfunktionen, Rauchbildung oder Bränden führen.

Um das Risiko von Kurzschlüssen, Kriechstrom, Stromschlägen, Fehlfunktionen, Rauchbildung oder Brand zu reduzieren, reinigen Sie die Fernsteuerung nicht mit Wasser oder anderen Flüssigkeiten.

Um das Risiko von Stromschlägen, Fehlfunktionen, Rauchbildung oder Brand zu reduzieren, bedienen Sie die Schalter/Tasten bzw. berühren Sie andere elektrische Teile nicht mit nassen Händen.

Für die Desinfektion der Anlage Alkohol benutzen und Raum ausreichend lüften. Die Alkoholdämpfe in der Nähe der Anlage können beim Einschalten der Anlage Feuer oder Explosion verursachen.

Um das Risiko von Verletzungen oder Stromschlägen zu reduzieren, halten Sie den Betrieb an und decken Sie die Fernsteuerung ab, bevor Sie Chemikalien in der Nähe der Fernsteuerung versprühen.

Um das Risiko von Verletzungen oder Stromschlägen zu reduzieren, halten Sie den Betrieb an und schalten Sie die Stromversorgung aus, bevor Sie die Fernsteuerung reinigen, warten oder untersuchen.

Falls Sie Unregelmäßigkeiten (z.B. Brandgeruch) feststellen, stoppen Sie den Betrieb, schalten Sie die Stromversorgung aus und wenden Sie sich umgehend an Ihren Händler. Eine weitere Benutzung kann Stromschläge, Funktionsstörungen oder Feuer verursachen.

Bringen Sie alle erforderlichen Abdeckungen an, um Feuchtigkeit und Staub von der Fernsteuerung fernzuhalten. Staub- und Wasseransammlungen können zu Stromschlägen, Rauchbildung oder Brand führen.

VORSICHT

Um das Risiko von Brand oder Explosionen zu reduzieren, platzieren Sie in der Nähe der Fernsteuerung keine entzündlichen Materialien oder versprühen Sie keine entzündlichen Sprays.

Um das Beschädigungsrisiko der Fernsteuerung zu reduzieren, sprühen Sie keine Insektizide oder andere entzündlichen Sprays direkt auf die Fernsteuerung.

Um das Risiko einer Umweltverschmutzung zu reduzieren, wenden Sie sich für die richtige Entsorgung der Fernsteuerung an eine autorisierte Stelle.

Um das Risiko von Stromschlägen oder Fehlfunktionen zu reduzieren, berühren Sie das Touch-Panel, die Schalter oder Tasten nicht mit einem spitzen oder scharfen Gegenstand.

Um das Risiko von Verletzungen oder Stromschlägen zu reduzieren, vermeiden Sie den Kontakt mit scharfen Kanten bestimmter Bauteile.

Um Verletzungen durch Glasscherben zu vermeiden, üben Sie keinen starken Druck auf die Glasteile aus.

Um das Risiko von Verletzungen zu verringern, tragen Sie bei der Arbeit an der Steuerung Schutzausrüstung.

Reparatur der Steuerung

WARNUNG

Die Steuerung darf nur von einer qualifizierten Fachkraft repariert oder versetzt werden. Bauen Sie die Steuerung nicht auseinander oder modifizieren Sie sie nicht.

Eine unsachgemäße Installation oder Reparatur kann zu Verletzungen, Stromschlägen oder Brand führen.

VORSICHT

Um das Risiko von Kurzschlüssen, Stromschlägen, Brand oder Fehlfunktionen zu reduzieren, berühren Sie die Leiterplatte weder mit Werkzeugen noch mit Ihren Händen. Vermeiden Sie zudem, dass sich darauf Staub ansammelt.

Zusätzliche Vorsichtsmaßnahmen

Um Schaden an der Steuerung zu vermeiden, dürfen nur die entsprechenden Werkzeuge zur Installation, Untersuchung oder Reparatur der Steuerung verwendet werden.

Diese Steuerung ist ausschließlich für die Verwendung mit dem Gebäudeverwaltungssystem von Mitsubishi Electric konzipiert. Die Verwendung dieser Steuerung mit anderen Systemen oder zu anderen Zwecken könnte zu Fehlfunktionen führen.

Dieses Gerät ist nicht für die Verwendung durch Personen (einschließlich Kinder) mit verminderten physischen, Wahrnehmungs- oder geistigen Fähigkeiten oder mit mangelnder Erfahrung oder mangelnden Kenntnissen vorgesehen, es sei denn, sie werden von einer für ihre Sicherheit verantwortlichen Person bei der Verwendung des Geräts überwacht bzw. in diese eingewiesen. Kinder sollten beaufsichtigt werden, um zu gewährleisten, dass sie nicht mit dem Gerät spielen.

Um Verfärbungen zu vermeiden, darf die Steuerung nicht mit Benzol, Verdünnern oder chemisch behandelten Tüchern gereinigt werden. Reinigen Sie die Steuerung, indem Sie ein mildes Reinigungsmittel in Wasser geben, ein weiches Tuch damit befeuchten und die Steuerung abwischen. Entfernen Sie Reinigungsmittelreste dann mit einem in Wasser getauchtes Tuch, und wischen Sie das Gerät am Ende mit einem trockenen Tuch ab.

Um Schäden an der Steuerung zu vermeiden, muss das Gerät gegen statische Elektrizität geschützt werden.

Diese Anlage ist für die Verwendung durch Fachleute oder geschulte Anwender in Ladengeschäften, in der Leichtindustrie oder auf Bauernhöfen oder für eine gewerbliche Verwendung durch Laien vorgesehen.

Ist das Stromversorgungskabel beschädigt, muss es vom Hersteller, seinem Kundendienst oder ähnlich qualifizierten Personen ersetzt werden, um Gefahren zu vermeiden.

Steuerungskomponenten

Steuerungseinheit - Status-Display/Hauptdisplay

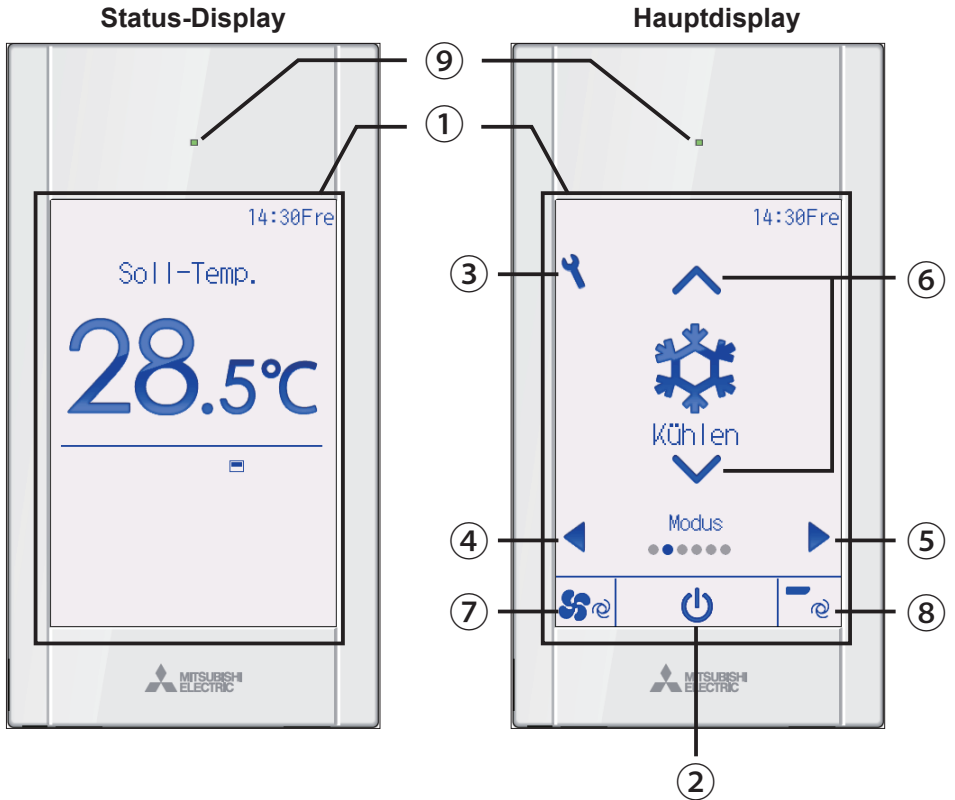

① Touch-Panel und Farb-LCD mit Hintergrundbeleuchtung

Betriebseinstellung wird angezeigt. Bei ausgeschalteter Hintergrundbeleuchtung schaltet das Drücken auf einen beliebigen Bereich den Bildschirm auf das Status-Display. Wird während der Anzeige des Status-Displays ein beliebiger Bereich berührt, dann wird der Bildschirm auf das Hauptdisplay umgeschaltet.

② EIN/AUS-Taste

Drücken, um das Innengerät EIN/AUS zu schalten.

③ Einstellung-Taste

Drücken, um das Hauptmenü anzuzeigen. Wenn die Menübedienung gesperrt ist, ist ein Administrator-Passwort erforderlich.

④ ⏪-Taste

Drücken, um zwischen den Einstellungen in der folgenden Reihenfolge umzuschalten: Louver, Ventilation, Vane, Lüfterdrehzahl, Betriebsart und voreingestellte Temperatur.

⑤ ⏩-Taste

Drücken, um zwischen den Einstellungen in der folgenden Reihenfolge umzuschalten: voreingestellte Temperatur, Betriebsart, Lüfterdrehzahl, Ventilation, Vane und Louver.

⑥ ▲ ▼-Taste

Drücken, um den Inhalt der in ④ und ⑤ oben ausgewählten Einstellung zu ändern.

⑦ Schnelleinstellungstaste Lüfterdrehzahl

Drücken, um direkt zum Bildschirm für die Einstellung der Lüfterdrehzahl zu gelangen.

⑧ Schnelleinstellungstaste Vane

Drücken, um direkt zum Bildschirm für die Vane-Einstellung zu gelangen.

⑨ EIN/AUS-Leuchte

Diese Lampe leuchtet grün, wenn die Anlage eingeschaltet ist, wenn „LED-Licht“ nicht auf „Nein“ gesetzt ist. Sie blinkt, wenn die Fernsteuerung startet oder ein Fehler vorliegt.

Wenn der Ein-/Ausschalter gesperrt ist, wird ② nicht angezeigt.

Beim Schalten der Einstellung mit der Taste ④ oder ⑤ wird die Einstellung nicht angezeigt, wenn der Betrieb der ausgewählten Einstellung gesperrt ist.

Bei Betrieb von Lüfterdrehzahl bzw. Vane muss die Einstellung ⑦ oder ⑧ nicht angezeigt.

Der Einstellungsinhalt lässt sich mit der Taste ⑥ nicht ändern, wenn die Einstellung zentral durch die Systemsteuerung gesteuert wird.

Steuerungskomponenten

Steuerungseinheit - Menübildschirm

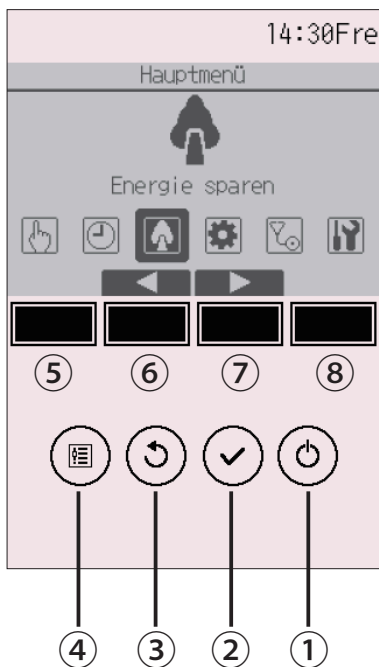

① EIN/AUS-Taste

Drücken, um das Innengerät EIN/AUS zu schalten.

② AUSWAHL-Taste

Drücken, um die Einstellung zu speichern.

③ ZURÜCK-Taste

Drücken, um zur vorhergehenden Anzeige zu wechseln.
Bei angezeigtem Hauptmenü wird durch Drücken dieser Taste das Status-Display angezeigt.

④ MENÜ-Taste

Seite 24

Drücken, um das Hauptmenü anzuzeigen.

⑤ Funktionstaste F1

Menübildschirm: Die Tastenfunktion variiert je nach Bildschirm.

⑥ Funktionstaste F2

Hauptmenü: Drücken, um die Marke nach links zu bewegen.

Menübildschirm: Die Tastenfunktion variiert je nach Bildschirm.

⑦ Funktionstaste F3

Hauptmenü: Drücken, um die Marke nach rechts zu bewegen.

Menübildschirm: Die Tastenfunktion variiert je nach Bildschirm.

⑧ Funktionstaste F4

Menübildschirm: Die Tastenfunktion variiert je nach Bildschirm.

Die Funktionen der Funktionsknöpfe ändern sich je nach Anzeige. Details finden Sie in der Funktionshilfe für Knöpfe, welche für die Funktion der aktuellen Anzeige am unteren Teil des LCD erscheint.

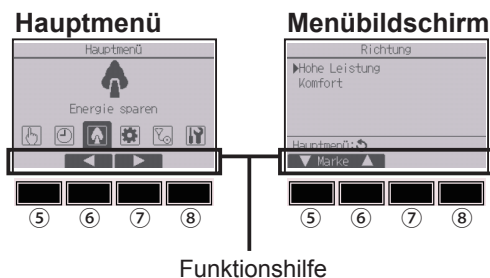

Steuerungskomponenten

Display - Status-Display/Hauptdisplay

Status- und Hauptdisplay können auf zwei verschiedene Arten angezeigt werden: „Komplett“ und „Einfach“.
Werkseinstellung ist „Komplett“. Informationen zum Umschalten zwischen den Modi finden Sie auf Seite 58.

Komplett-Modus

* Alle Symbole werden als Erklärung angezeigt.

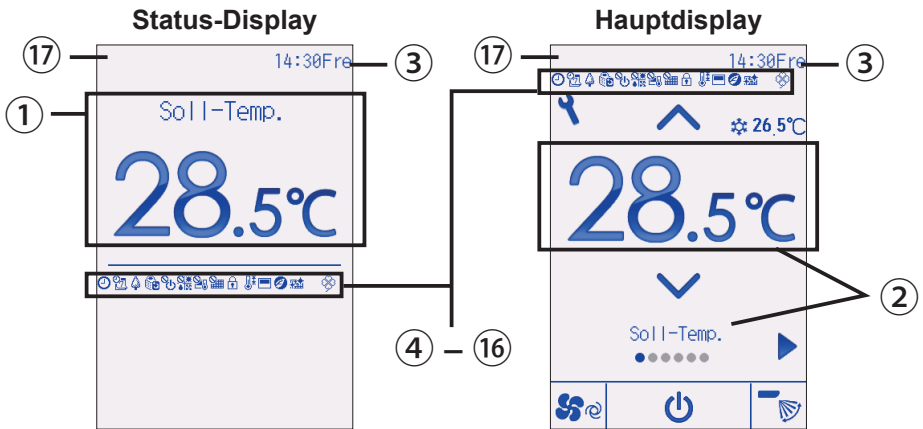

Einfach-Modus

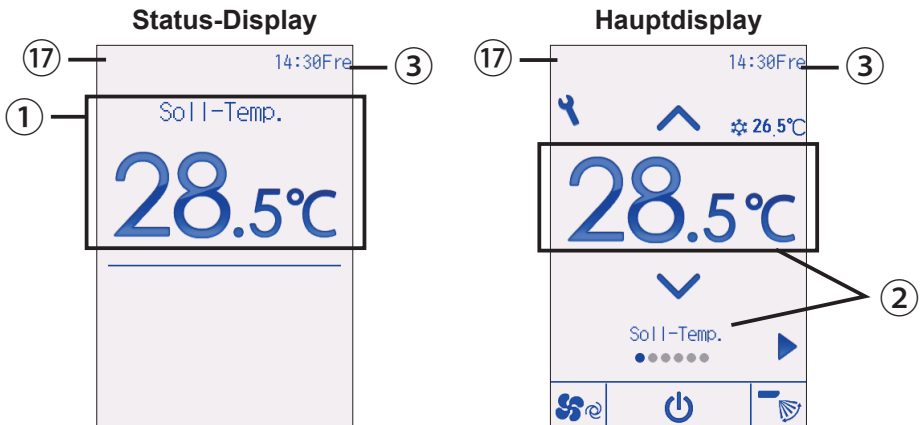

① Voreingestellte Temperatur oder Raumtemperatur

Voreingestellte Temperatur oder Raumtemperatur erscheinen hier. (Siehe Installationsanleitung.)

② Einstellung und Einstellungsinhalt Seite 17

Die Einstellungen „Voreingestellte Temperatur“ ↔ „Betriebsart“ ↔ „Lüfterdrehzahl“ ↔ „Vane“ ↔ „Ventilation“ ↔ „Louver“, und deren Einstellungsinhalt erscheinen hier. „Zentral gesteuert“ wird einen bestimmten Zeitraum lang angezeigt, wenn ein zentral gesteuertes Element in Betrieb ist.

③ Uhr

Hier erscheint die aktuelle Zeit. (Siehe Installationsanleitung.)

④ Seite 29, 32, 40

Wird angezeigt, wenn der „Ein/Aus-Timer“ (Seite 29), die „Nachtabsenkung“ (Seite 40) oder die Funktion „Ausschalt-Timer“ (Seite 32) aktiviert ist.

 wird angezeigt, wenn der Timer durch das zentrale Steuerungssystem deaktiviert wird.

⑤ Seite 34

Erscheint, wenn die Wochenzeituhr aktiviert ist.

⑥ Seite 51

Erscheint, wenn die Anlagen im Energiesparmodus betrieben werden. (Wird bei einigen Innengerätmodellen nicht angezeigt)

⑦ Seite 37

Erscheint, wenn die Außengeräteanlagen im Flüstermodus betrieben werden.

⑧ Seite 37

Erscheint, wenn die „EIN/AUS“ Bedienung zentralgesteuert wird.

⑨ Seite 17

Erscheint, wenn die Betriebsart zentralgesteuert wird.

⑩ Seite 17

Erscheint, wenn die voreingestellte Temperatur zentralgesteuert wird.

⑪ Seite 17

Erscheint, wenn die Rückstellung des Filters zentralgesteuert wird.

⑫ Seite 46

Erscheint, wenn die Knöpfe gesperrt sind.

⑬ Seite 43

Erscheint, wenn der voreingestellte Temperaturbereich eingeschränkt ist.

⑭ Seite 43

Erscheint, wenn der eingebaute Thermistor in der Fernsteuerung aktiviert ist, um die Raumtemperatur zu überwachen(a).

 erscheint, wenn der Thermistor an der Innengeräteanlage zur Überwachung der Raumtemperatur aktiviert ist.

⑮ Seite 43

Erscheint, wenn ein Energie sparender Betrieb mit einer „3D i-See sensor“-Funktion ausgeführt wird.

⑯ Seite 78

Zeigt an, wenn die Filter gewartet werden müssen.

⑰ **Vorläufige Fehleranzeige**

Ein Fehlercode erscheint während eines vorläufigen Fehlers.

Menüstruktur und Symbole

Menüstruktur

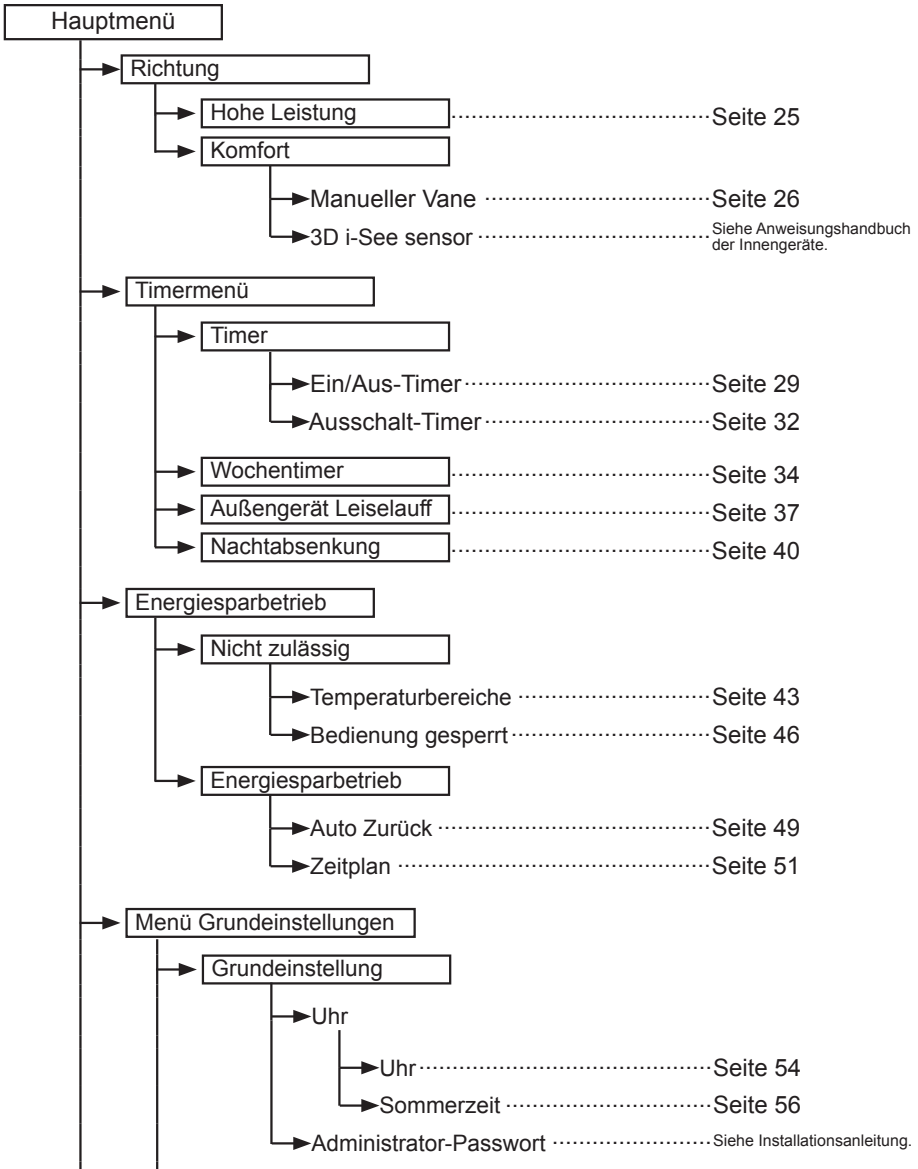

→	Anzeigeeinstellung	
	→ Hauptdisplay	Seite 58
	→ Displaydetails (Symbolbeschreibungen usw.)	Siehe Installationsanleitung.
	→ Helligkeit	Seite 61
	→ Sprachauswahl	Seite 62
	→ Design	Seite 64
→	Betriebseinstellung	
	→ Automatik	Siehe Installationsanleitung.
→	Touch-Panel	Seite 66
→	Wartungsmenü	
	→ Störungsinformation	Seite 74
	→ Filterinformationen	Seite 78
	→ Reinigung	
	→ Filter-Lift-Blende	Siehe Anweisungshandbuch im Lieferumfang der Filter-Lift-Blende.
	→ Absenkungsvorgang	Siehe Anweisungshandbuch im Lieferumfang der Filter-Lift-Blende.
	→ Absenkungsanpassung	Siehe Anweisungshandbuch im Lieferumfang der Filter-Lift-Blende.
→	Service-Menü	
	→ Testlauf-Menü	
	→ Testlauf	Siehe Installationsanleitung des Innengeräts.
	→ Testlauf Kondensatpumpe	Siehe Installationsanleitung des Innengeräts.
	→ Wartungsinformationen	Siehe Installationsanleitung des Innengeräts.
	→ Eingabe Modellname	Siehe Installationsanleitung des Innengeräts.
	→ Eingabe Seriennummer	Siehe Installationsanleitung des Innengeräts.
	→ Eingabe Händlerinformationen	Siehe Installationsanleitung des Innengeräts.
	→ Wartungsinfos erstellen	Siehe Installationsanleitung des Innengeräts.

Menüstruktur und Symbole

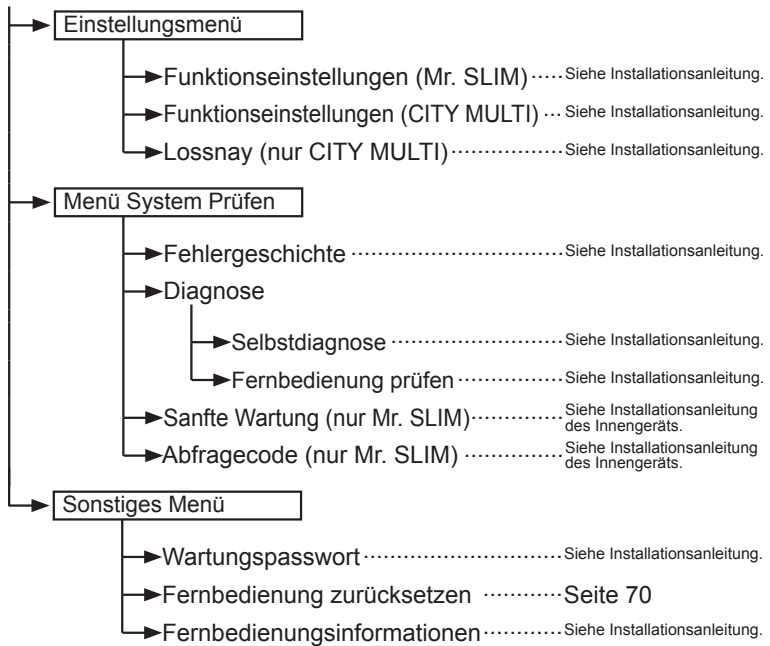

Nicht bei allen Innengerätmodellen sind alle Funktionen verfügbar.

Steuerungsbedienung

Timer



Die Tabelle unten gibt einen Überblick der benutzten quadratischen Symbole in diesem Handbuch.



Um die Einstellungen zu ändern, muss das Administrator-Passwort oder das Wartungs-Benutzerpasswort in das Passwort-Eingabefeld eingegeben werden. Keine Einstellung kann diesen Schritt überspringen.



F1 F2 F3 F4

- F1** : Drücken, um die Marke nach links zu bewegen.
- F2** : Drücken, um die Marke nach rechts zu bewegen.
- F3** : Drücken, um den Wert um 1 zu verringern.
- F4** : Drücken, um den Wert um 1 zu erhöhen.

* Änderungen können nur gemacht werden, wenn das Passwort richtig eingegeben wurde.



Zeigt die Einstellungen an, die nur geändert werden können, wenn die Einheiten in Betrieb sind.



Zeigt Einstellungen an, die nur geändert werden können, wenn die Einheiten nicht in Betrieb sind.



Zeigt Einstellungen an, die nur geändert werden können, während die Einheiten im Modus „Kühlen“, „Heizen“ oder „Auto“ benutzt werden.



Zeigt Funktionen an, die nicht vorhanden sind, wenn die Knöpfe gesperrt sind, oder das System zentralgesteuert wird.

Grundfunktionen

EIN/AUS-Schalter



Tastenbedienung

EIN



EIN/AUS-Taste

Drücken Sie die **EIN/AUS**-Taste.

Die EIN/AUS-Lampe leuchtet grün, wenn der Betrieb startet.

Ist „LED-Licht“ auf „Nein“ gesetzt, leuchtet die EIN/AUS-Leuchte nicht.

AUS

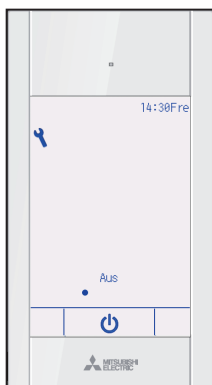

Die **EIN/AUS**-Taste erneut drücken.

Die EIN/AUS-Lampe leuchtet nicht mehr, und der Betrieb stoppt.



Tastenbedienung

Betriebsart



Jede Betätigung der Tasten ▼ oder ▲ schaltet durch die folgenden Betriebsarten.

Wählen Sie die gewünschte Betriebsart aus.



Kühlen



Trocken



Lüfter



Auto



Heizen

- Für die angeschlossene Innengeräteanlage nicht zur Verfügung stehende Betriebsarten werden nicht angezeigt.

Was bedeutet das blinkende Modussymbol?

Das Modussymbol blinkt, wenn andere Innengeräteanlagen im gleichen Kältemittelsystem (an dieselbe Außengeräteanlage angeschlossen) bereits in einer anderen Betriebsart arbeiten. In diesem Fall können die verbleibenden Anlagen der gleichen Gruppe nur im selben Modus arbeiten.

<Modus „Auto“ (Doppel-Sollwert)>

Wenn „Auto“ (Doppel-Sollwert) als Betriebsart eingestellt ist, können zwei Temperaturvoreinstellungen (jeweils eine für Kühlen und Heizen) festgelegt werden. Abhängig von der Raumtemperatur wird die Innengeräteanlage automatisch in den Modus „Kühlen“ oder „Heizen“ schalten und die Raumtemperatur innerhalb des eingestellten Bereichs halten.

Das Diagramm unten zeigt das Betriebssystem einer im Modus „Auto“ (Doppel-Sollwert) betriebenen Innengeräteanlage.

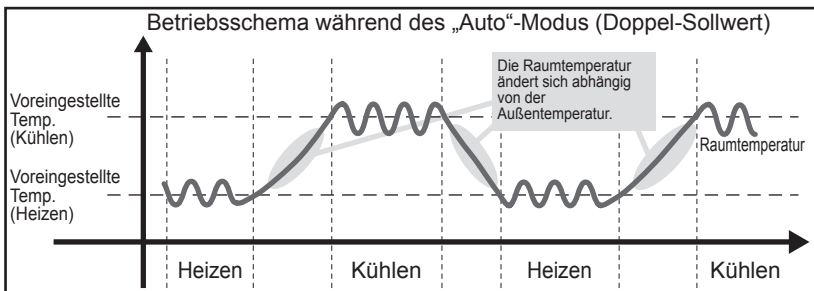

Grundfunktionen

Voreingestellte Temperatur

<„Kühlen“, „Trocknen“, „Heizen“ und „Auto“ (Einzel-Sollwert)>

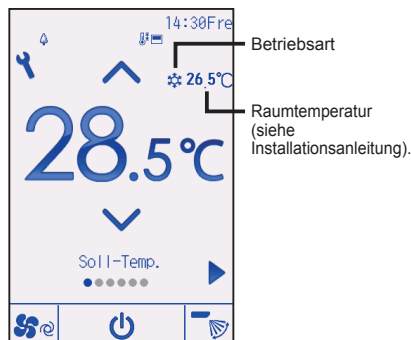

Drücken Sie die -Taste, um die voreingestellte Temperatur zu verringern, und , um sie zu erhöhen.

- Die einstellbaren Temperaturbereiche der unterschiedlichen Betriebsarten finden Sie in der Tabelle auf Seite 19.
- Voreingestellte Temperaturbereiche können nicht für den Betrieb Lüfter/Ventilation eingestellt werden.
- Die voreingestellte Temperatur wird entweder in Celsius in Schritten von 0,5 oder 1 Grad oder in Fahrenheit angezeigt, abhängig vom Modell des Innengeräts und vom eingestellten Anzeigemodus an der Fernsteuerung.

<Modus „Auto“ (Doppel-Sollwert)>

1

Voreingestellte
Kühltemperatur

Voreingestellte
Heiztemperatur

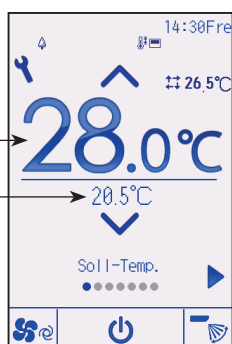

Die aktuell voreingestellten Temperaturen werden eingeblendet.

Jede Betätigung der Tasten oder schaltet die voreingestellten Temperaturen für Kühlen oder Heizen.

2

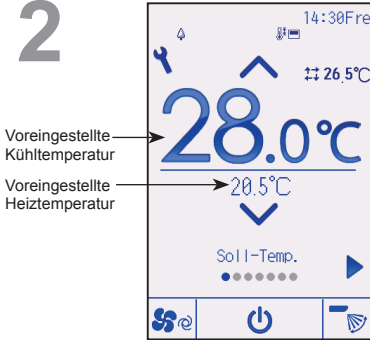

Drücken Sie die ▼-Taste, um die ausgewählte Temperatur zu verringern, und ▲, um sie zu erhöhen.

- Die einstellbaren Temperaturbereiche der unterschiedlichen Betriebsarten finden Sie in der Tabelle unten.
- Die Temperaturvoreinstellungen für Kühlen und Heizen im Modus „Auto“ (Doppel-Sollwert) werden auch von den Modi „Kühlen“/„Trocken“ und „Heizen“ verwendet.
- Die Temperaturvoreinstellungen für Kühlen und Heizen im Modus „Auto“ (Doppel-Sollwert) müssen die folgenden Bedingungen erfüllen:
 - Die voreingestellte Kühltemperatur ist höher als die voreingestellte Heiztemperatur.
 - Die erforderliche Mindesttemperaturdifferenz zwischen den Temperaturvoreinstellungen für Kühlen und Heizen (variiert je nach angeschlossenen Innengerätmodellen) wird eingehalten.
 - Wenn die Temperaturen so voreingestellt wurden, dass die erforderliche Mindesttemperaturdifferenz nicht eingehalten ist, werden beide voreingestellten Temperaturwerte innerhalb der zulässigen Einstellungsbereiche geändert.

Einstellbarer Bereich der voreingestellten Temperatur

Betriebsart	Voreingestellter Temperaturbereich
Kühlen/Trocken	19 ~ 30°C (67 ~ 87°F)
Heizen	17 ~ 28°C (63 ~ 83°F)
„Auto“ (Einzel-Sollwert)	19 ~ 28°C (67 ~ 83°F)
„Auto“ (Doppel-Sollwerte)	[Kühlen] Voreingestellter Temperaturbereich für den Modus „Kühlen“ [Heizen] Voreingestellter Temperaturbereich für den Modus „Heizen“
Gebläse/Ventilation	Nicht einstellbar

Der einstellbare Temperaturbereich variiert mit der Ausführung der Innengeräteanlage.

Grundfunktionen

Lüfterdrehzahl

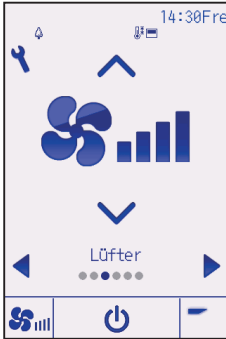

Jede Betätigung der Tasten ▼ oder ▲ schaltet durch die folgenden Lüfterdrehzahlen.

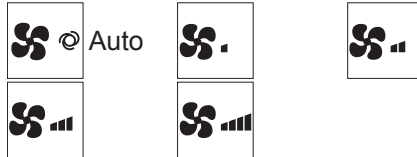

- Die verfügbaren Lüfterdrehzahlen hängen vom Modell der Innengeräteanlage ab.

Vane-Einstellung

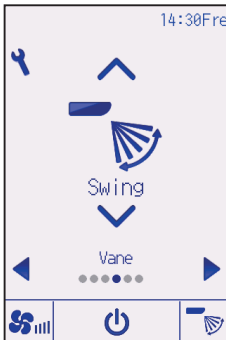

(Beispielanzeige bei CITY MULTI)

Jede Betätigung der Tasten ▼ oder ▲ schaltet durch die folgenden Vane-Einstellungen.
Wählen Sie die gewünschte Einstellung.

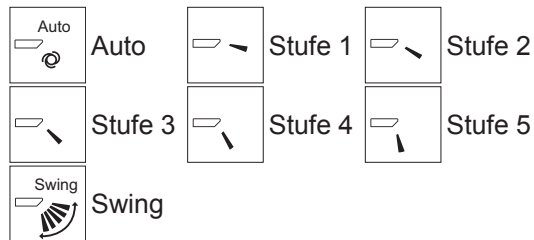

Wählen Sie „Swing“, damit sich die Vane automatisch auf und ab bewegen.
Bei Auswahl von „Stufe 1“ bis „Stufe 5“ werden die Vane in der gewählten Position fixiert.

- **1h** links vom Flügeleinstellungssymbol
Dieses Symbol erscheint, wenn die Vane auf Stufe 2, 3, 4 oder 5 gestellt sind und der Lüfter im Kühl- oder Trockenmodus mit langsamer Geschwindigkeit arbeitet (abhängig vom Modell). Das Symbol erlischt in einer Stunde und die Vane-Einstellung ändert sich automatisch.

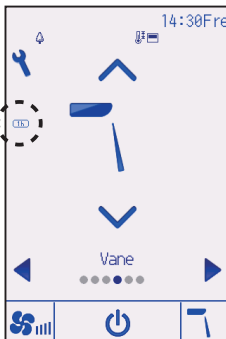

Louver-Einstellung

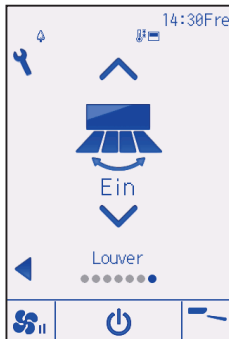

(Beispielanzeige bei CITY MULTI)

Drücken Sie die Tasten ▼ oder ▲, um die Louver-Drehung ein- oder auszuschalten.



Aus



Ein

Ventilationseinstellung

Die Ventilationseinstellung kann auch geändert werden, wenn die Anlagen in Betrieb sind.



(Beispielanzeige bei Mr. SLIM)

Jede Betätigung der Tasten ▼ oder ▲ schaltet durch die folgenden Ventilationseinstellungen.

* Nur einstellbar, wenn eine Lossnay Anlage angeschlossen ist.



Aus



Niedrig



Hoch

• Bei einigen Innengeräteanlagen kann der Lüfter mit bestimmten Ventilationsanlagen gekoppelt sein.

Navigation durch das Menü

Hauptmenüliste

Hauptmenü	Einstellung		Einstellungsdetails	Seite
Richtung	Hohe Leistung		Damit kann eine komfortable Raumtemperatur schnell erreicht werden. <ul style="list-style-type: none"> Anlagen können bis zu 30 Minuten lang im Hochleistungsmodus betrieben werden. 	25
	Komfort	Manueller Vane	Festlegen des Vane-Winkels.	26
Timer	Timer	Ein/Aus-Timer	Einstellen der Ein/Aus Betriebszeiten. <ul style="list-style-type: none"> Die Zeit kann in 5-Minuten-Schritten eingestellt werden. Die Uhr muss eingestellt sein. 	29
		Ausschalt-Timer	Einstellen der Auto-Aus Zeiten. <ul style="list-style-type: none"> Die Zeit kann in 10-Minuten-Schritten zwischen 30 und 240 eingestellt werden. 	32
	Wochentimer		Einstellen der Ein/Aus Zeiten. <ul style="list-style-type: none"> Bis zu acht Betriebszeiten können pro Tag eingestellt werden. Es können zwei Wochenzeitpläne gewählt werden. Die Uhr muss eingestellt sein. Nicht gültig, wenn der Ein/Aus-Timer deaktiviert ist. 1°C-Schritte 	34
	Außengerät Leiselauf		Einstellen der Zeitabschnitte, bei denen ein leiser Betrieb der Außengeräteanlage Vorrang vor der Temperaturregelung hat. Start/Stopp Zeiten für jeden Tag der Woche einstellen. <ul style="list-style-type: none"> Den gewünschten Geräuschpegel aus „Normal“, „Mittel“ und „Leise“ auswählen. Die Uhr muss eingestellt sein. 	37
	Nachtabsenkung		Nachtabsenkung einstellen. <ul style="list-style-type: none"> Wählen Sie „Ja“, um die Einstellung zu aktivieren und „Nein“ um sie zu deaktivieren. Der Temperaturbereich und die Start/Stopp Zeit kann eingestellt werden. Die Uhr muss eingestellt sein. 1°C-Schritte 	40
Energie-sparbetrieb	Nicht zulässig	Temperaturbereiche	Voreingestellten Temperaturbereich einschränken. <ul style="list-style-type: none"> Verschiedene Temperaturbereiche können für verschiedene Betriebsarten eingestellt werden. 1°C-Schritte 	43
		Bedienung gesperrt	Ausgewählte Funktionen sperren. <ul style="list-style-type: none"> Die gesperrten Funktionen können nicht aktiviert werden. 	46
	Energie-sparbetrieb	Auto Zurück	Anlage geht in den Betriebsmodus mit vorbestimmter Temperatur, nachdem sie eine bestimmte Zeit im Energiesparmodus war. <ul style="list-style-type: none"> Die Zeit kann in 10-Minuten-Schritten zwischen 30 und 120 eingestellt werden. Diese Funktion ist nicht verfügbar, wenn der voreingestellte Temperaturbereich eingeschränkt ist. 1°C-Schritte 	49

Hauptmenü	Einstellung		Einstellungsdetails	Seite
Energie-sparbetrieb	Energie-sparbetrieb	Zeitplan	Start/Stopp-Zeit für jeden Tag der Woche einstellen, um die Anlagen im Energiesparmodus zu betreiben und Energiesparrate einstellen. <ul style="list-style-type: none"> • Bis zu vier Energiesparmethoden können pro Tag eingestellt werden. • Die Zeit kann in 5-Minuten-Schritten eingestellt werden. • Die Energiesparrate kann in 10%-Schritten von 0% und von 50 bis 90% eingestellt werden. * Die Uhr muss eingestellt sein.	51
Grund-einstellungen	Grund-einstellungen	Uhr	Einstellen der aktuellen Zeit.	54
		Sommerzeit	Dient zum Einstellen der Sommerzeit.	56
	Anzeige-einstellung	Hauptdisplay	Dient zum Umschalten zwischen „Komplett“- und „Einfach“-Modus des Status- und Hauptdisplays. <ul style="list-style-type: none"> • Standardeinstellung: „Komplett“ 	58
		Helligkeit	Dient zum Einstellen der Bildschirmhelligkeit.	61
		Sprachauswahl	Gewünschte Sprache auswählen.	62
		Design	Dient zum Ändern der Farbe von Status- und Hauptdisplay.	64
	Touch-Panel	Touch-Panel-Kalibrierung	Legt die Kalibrierungseinstellungen für das Touch Panel fest.	66
Touch-Panel-Reinigung		Schaltet das Touch Panel für die Reinigung zeitweise ab, damit es nicht reagiert.	68	
Service	Fernbedienung zurücksetzen		Dient zum Zurücksetzen der Fernbedienung auf die Werkseinstellungen.	70
	Fernbedienungsinformation		Dient zur Anzeige von Modellnamen, Softwareversion und Seriennummer der Fernsteuerung.	72
Wartung	Störungsinformation		Fehlerinformationen bei aufgetretenen Fehlern kontrollieren. <ul style="list-style-type: none"> • Fehlercode, Fehlerquelle, Kühlmitteladresse, Anlagemodell, Hersteller Nummer, Kontaktinformationen (Telefonnummer des Lieferanten) können angezeigt werden. * Anlagenmodell, Hersteller Nummer und Kontaktinformationen müssen registriert werden, bevor sie angezeigt werden können.	74
	Filterinformationen		Filterstatus kontrollieren. <ul style="list-style-type: none"> • Das Filterzeichen kann zurückgesetzt werden. 	78

Navigation durch das Menü

Navigation durch das Hauptmenü

Tastenbedienung

Hauptmenü aufrufen



Drücken Sie auf dem Hauptdisplay auf die **Einstellung**-Taste.

Das Hauptmenü erscheint.

Objektauswahl



F2 drücken, um die Marke nach links zu bewegen.

F3 drücken, um die Marke nach rechts zu bewegen.

Funktionseinstellungen

Hohe Leistung



Funktionsbeschreibung

Im Hochleistungsbetrieb arbeiten die Anlagen mit höherer Leistung als normal, um die Raumluft schneller an die optimale Temperatur zu klimatisieren. Diese Betriebsart dauert bis zu 30 Minuten, danach oder wenn die voreingestellte Temperatur erreicht ist, was immer zuerst eintritt, kehrt die Anlage in den normalen Betriebsmodus zurück. Die Anlagen kehren in die normale Betriebsart zurück, wenn der Betriebsmodus oder die Lüfterdrehzahl geändert wird.

Tastenbedienung

1



Wählen Sie während des Kühl-, Heiz- oder AUTO-Betriebs aus dem Menü „Richtung“ „Hohe Leistung“ und drücken Sie die Taste **AUSWAHL**.

„Hohe Leistung“ ist nur bei Modellen verfügbar, die diese Funktion unterstützen.

2



Bewegen Sie die Marke mit den Tasten **F3** oder **F4** auf „Ja“ und drücken Sie auf **AUSWAHL**.

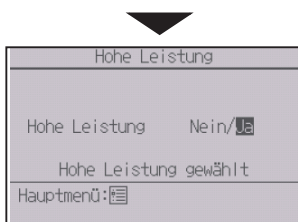

Ein Bestätigungsbildschirm wird angezeigt.

Navigation durch die Bildschirme

- Zurück zum Hauptmenü **MENÜ**-Taste
- Zurück zum vorhergehenden Bildschirm **ZURÜCK**-Taste

Funktionseinstellungen

Manueller Vane

OFF

Tastenbedienung

1



Wählen Sie „Komfort“ aus dem Menü „Richtung“ und drücken Sie auf **AUSWAHL**.

2



Wählen Sie mit den Tasten **F1** oder **F2** „Manueller Vane“ und drücken Sie auf **AUSWAHL**.

3

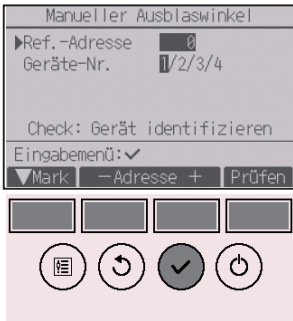

Bewegen Sie die Marke mit **[F1]** auf „Ref.-Adresse“ oder „Geräte-Nr.“.

Wählen Sie mit **[F2]** oder **[F3]** die Kühlmitteladresse (Ref.-Adresse) und Anlagennummer (Geräte-Nr.) für die Anlagen aus, dessen Vanes Sie einstellen möchten und drücken Sie **[AUSWAHL]**.

- Ref.-Adresse: Kühlmitteladresse
- Geräte-Nr.: 1, 2, 3, 4

Drücken Sie **[F4]**, um die Anlage zu bestätigen.

Die linke Abbildung ist eine Beispielanzeige von Mr. SLIM. Bei CITY MULTI Anlagen wird „M-NET-Adresse“ angezeigt anstatt „Ref.-Adresse“ und die „Geräte-Nr.“ wird nicht angezeigt.

4



Wählen Sie mit **[F1]** „Vane“.

Wählen Sie mit den Tasten **[F2]** oder **[F3]** „4-Wege“ oder „2-Wege“ und drücken Sie auf **[F4]**.

Funktionseinstellungen

5



Die aktuelle Vane-Einstellung erscheint.

Wählen Sie mit den Tasten **[F1]** oder **[F2]** die gewünschten Auslässe aus „1“, „2“, „3“, „4“ oder „1, 2, 3, 4 (alle Auslässe)“.

Drücken Sie die Tasten **[F3]** oder **[F4]**, um durch die Optionen zu gehen und den gewünschten Eintrag zu markieren.

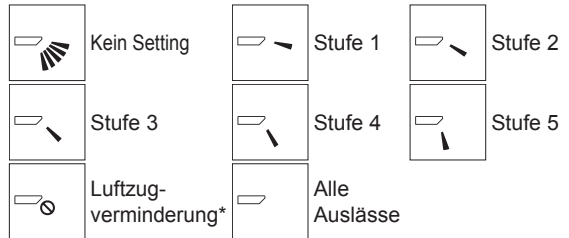

Drücken Sie die Taste **[AUSWAHL]**, um die Einstellungen zu speichern.

Ein Bildschirm zeigt an, dass die Einstellinformationen übertragen wurden.

Die Einstellungen werden für den ausgewählten Ausgang ausgeführt.

Der Bildschirm kehrt automatisch zum vorherigen Bildschirm zurück, wenn die Übertragung beendet ist.

Die Einstellungen für die anderen Ausgänge werden nach dem selben Ablauf durchgeführt.

Wenn alle Auslässe ausgewählt wurden, erscheint , wenn die Anlage das nächste Mal in Betrieb genommen wird.

Navigation durch die Bildschirme

- Zurück zur vorhergehenden Anzeige **[ZURÜCK]**-Taste

*Luftzugverminderung

Der Modus [Luftzugverminderung] hält den Vane-Winkel horizontaler als der Winkel von Stufe 1, sodass der Luftstrom nicht zu Personen hingeleitet wird.

Diese Funktion kann nur für einen Auslass eingestellt werden.

Diese Funktion ist nicht für Modelle mit zwei oder drei Auslässen einstellbar.

Im Luftzugverminderungsmodus kann der Luftstrom zu einer Dachverfärbung führen.

Timer (Ein/Aus-Timer)



Tastenbedienung

1

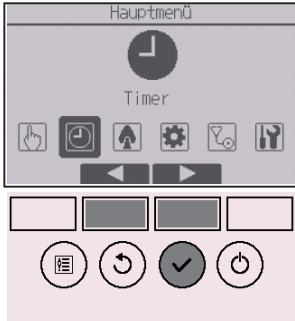

Wählen Sie „Timer“ vom Hauptmenü (siehe Seite 24) und drücken Sie die **AUSWAHL**-Taste.

Der Ein/Aus-Timer funktioniert in folgenden Fällen nicht:

wenn der „Ein/Aus-Timer“ deaktiviert ist, während eines Fehlers, während einer Überprüfung (im Service-Menü), während eines Testlaufs, während einer Diagnose der Fernsteuerung, wenn die Uhr nicht eingestellt ist, während einer Funktionseinstellung, wenn das System zentralgesteuert wird („Ein/Aus“-Betrieb oder „Timer“-Betrieb von der lokalen Fernsteuerung ist gesperrt).

2

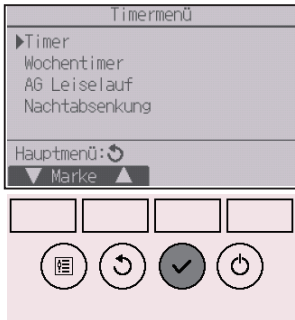

Bewegen Sie die Marke auf „Timer“ und drücken Sie die **AUSWAHL**-Taste.

3



Die aktuellen Einstellungen erscheinen.

Bewegen Sie die Marke auf „Ein/Aus-Timer“ und drücken Sie die **AUSWAHL**-Taste.

Funktionseinstellungen

4



Die Anzeige zum Einstellen des Timers erscheint.

Wählen Sie den gewünschten Menüpunkt mit den Tasten **F1** oder **F2** aus „Ein/Aus-Timer“, „Ein“, „Aus“ oder „Wiederh.“

5



Ändern Sie die Einstellung mit den Tasten **F3** oder **F4**.

- Ein/Aus-Timer: Nein (deaktiviert)/Ja (aktiviert)
- Ein: Betriebsstartzeit

(in 5-Minuten-Schritten einstellbar)

* Die Taste gedrückt halten, um die Ziffern schnell zu ändern.

- Aus: Betriebsstopzeit

(in 5-Minuten-Schritten einstellbar)

* Die Taste gedrückt halten, um die Ziffern schnell zu ändern.

- Wiederh.: Nein (einmalig)/Ja (wiederholend)

6



Drücken Sie die Taste **AUSWAHL**, um die Einstellungen zu speichern.

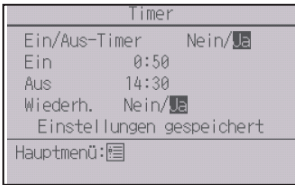



Ein Bestätigungsbildschirm wird angezeigt.

Navigation durch die Bildschirme

- Zurück zum Hauptmenü **MENÜ**-Taste
- Zurück zum vorhergehenden Bildschirm **ZURÜCK**-Taste



 erscheint auf dem Status- und Hauptdisplay im Komplett-Modus, wenn der „Ein/Aus-Timer“ aktiviert ist.

 erscheint, wenn der Timer durch das zentrale Steuerungssystem deaktiviert wird.

Funktionseinstellungen

Timer (Ausschalt-Timer)



Tastenbedienung

1



Öffnen Sie den Bildschirms für die Timer Einstellung.
(siehe Seite 29.)

Wählen Sie „Auto Aus“ und drücken Sie die

AUSWAHL-Taste.

Der Ausschalt-Timer funktioniert in folgenden Fällen nicht:

wenn der Ausschalt-Timer deaktiviert ist, während eines Fehlers, während einer Überprüfung (im Service-Menü), während eines Testlaufs, während einer Diagnose der Fernsteuerung, während einer Funktionseinstellung, wenn das System zentralgesteuert wird („Ein/Aus“-Betrieb oder „Timer“-Betrieb von der lokalen Steuerung ist gesperrt).

2



Die aktuellen Einstellungen erscheinen.

Bewegen Sie die Marke mit den Tasten **F1** oder **F2** auf „Ausschalt-Timer“ oder „Aus in --- min“ .

3



Ändern Sie die Einstellung mit den Tasten **F3** oder **F4**.

- Ausschalt-Timer: Nein (deaktiviert)/Ja (aktiviert)
- Aus in --- min: Zeiteinstellung (Der Bereich kann in 10-Minuten Schritten zwischen 30 und 240 Minuten eingestellt werden).

4



Drücken Sie die Taste **AUSWAHL**, um die Einstellungen zu speichern.

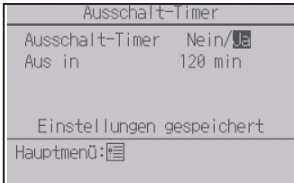

Ein Bestätigungsbildschirm wird angezeigt.

Navigation durch die Bildschirme

- Zurück zum Hauptmenü **MENÜ**-Taste
- Zurück zum vorhergehenden Bildschirm **ZURÜCK**-Taste



 erscheint auf dem Status- und Hauptdisplay im Komplett-Modus, wenn der „Ausschalt-Timer“ aktiviert ist.

 erscheint, wenn der Timer durch das zentrale Steuerungssystem deaktiviert wird.

Funktionseinstellungen

Wochentimer



Tastenbedienung

1



Wählen Sie „Wochentimer“ aus dem Timermenü und drücken Sie auf **AUSWAHL**.

Der „Wochentimer“ funktioniert in folgenden Fällen nicht:

wenn der „Ein/Aus-Timer“ aktiviert ist, wenn der „Wochentimer“ deaktiviert ist, während eines Fehlers, während einer Überprüfung (im Service-Menü), während eines Testlaufs, während einer Diagnose der Fernsteuerung, wenn die Uhr nicht eingestellt ist, während einer Funktionseinstellung, wenn das System zentralgesteuert wird („Ein/Aus“-Betrieb, Temperatureinstellung oder „Timer“-Betrieb von der lokalen Fernsteuerung ist gesperrt).

2



Die aktuellen Einstellungen erscheinen.

Drücken Sie die Tasten **F1** oder **F2**, um die Einstellungen für jeden Tag der Woche aufzurufen.

Drücken Sie **F3**, um Betriebszeitplan (Muster) 5 bis 8 aufzurufen.

Drücken Sie **F4**, um den Status von Einstellung 2 anzuzeigen.

Drücken Sie **AUSWAHL**, um die Einstellungsanzeige aufzurufen.

3

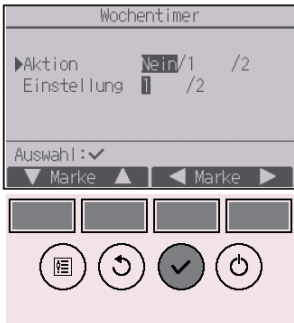

Die Einstellungen für den Wochentimer werden angezeigt.

Wählen Sie in der Einstellung „Aktion“ mit den Tasten **F3** oder **F4** „1“ bzw. „2“ zur Auswahl der Timereinstellung 1 bzw. 2. Dann die **AUSWAHL**-Taste drücken.

Zur Kontrolle der Einstellwerte für die Timereinstellungen 1 und 2 die Marke mit den Tasten **F1** oder **F2** auf „Einstellung“ bewegen und mit den Tasten **F3** oder **F4** „1“ oder „2“ auswählen.

4

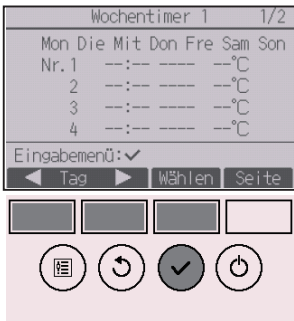

Die Anzeige für die Einstellung der Wochenzeitschaltuhr erscheint und die aktuellen Einstellungen werden angezeigt.

Bis zu acht Betriebszeiten können pro Tag eingestellt werden.

Bewegen Sie die Marke mit den Tasten **F1** oder **F2** auf den gewünschten Wochentag und drücken Sie die **F3**-Taste. (Es können mehrere Tage gewählt werden.)

Drücken Sie die **AUSWAHL**-Taste.

Funktionseinstellungen

5

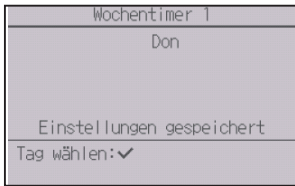
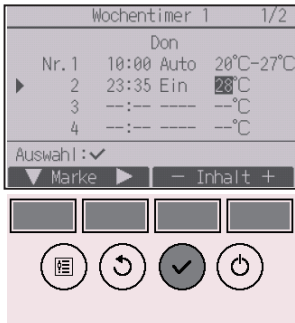

Es wird der Bildschirm für die Voreinstellung angezeigt.

Drücken Sie **[F1]**, um die Marke zur gewünschten Nummer zu bewegen.

Bewegen Sie die Marke mit **[F2]** auf die Zeit, Ein/Aus oder die Temperatur.

Ändern Sie die Einstellungen mit den Tasten **[F3]** oder **[F4]**.

- Zeit: in 5-Minuten-Schritten einstellbar
 - * Die Taste gedrückt halten, um die Ziffern schnell zu ändern.
- Ein/Aus/Auto: Die wählbaren Einstellungen sind abhängig vom Modell der angeschlossenen Innengeräteanlage. (Wenn ein „Auto“-Betriebsschema ausgeführt wird, arbeitet das System im Modus „Auto“ (Doppel-Sollwert).)
- Temperatur: Der einstellbare Temperaturbereich variiert je nach angeschlossenen Innengeräteanlagen. (1°C-Schritte) Wenn der Modus „Auto“ (Doppel-Sollwert) gewählt wird, können zwei Temperaturvoreinstellungen festgelegt werden. Wenn während des Modus „Auto“ (Doppel-Sollwert) ein Betriebsschema mit einer einzelnen Temperaturvoreinstellung ausgeführt wird, wird dessen Einstellung als Kühlttemperatureinstellung im Modus „Kühlen“ angewendet.

Drücken Sie die Taste **[AUSWAHL]**, um die Einstellungen zu speichern.

Ein Bestätigungsbildschirm wird angezeigt.

Navigation durch die Bildschirme

- Zurück zur Einstellungsanzeige Wochentag ändern..... **[AUSWAHL]**-Taste
- Zurück zum Hauptmenü **[MENÜ]**-Taste
- Zurück zur vorhergehenden Anzeige **[ZURÜCK]**-Taste

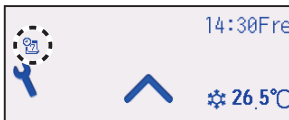

[7] erscheint auf dem Status- und Hauptdisplay im Komplett-Modus, wenn die Einstellung für den aktuellen Tag im Wochentimer existiert.

Das Symbol erscheint nicht, während der „Ein/ Aus“-Timer aktiviert ist oder das System zentral gesteuert wird („Timer“-Betrieb von lokaler Fernsteuerung ist gesperrt).

Funktionsbeschreibung

Diese Funktion ermöglicht dem Benutzer die Einstellung der Zeitabschnitte, bei denen ein leiser Betrieb der Außengeräteanlage Vorrang vor der Temperatursteuerung hat. Start- und Stoppzeiten für jeden Tag der Woche für den Flüstermodus einstellen. Wählen Sie die gewünschte Leiselaufstufe aus „Mittel“ und „Leise“.

Tastenbedienung

1



Wählen Sie „AG Leiselauf“ aus dem Timermenü und drücken Sie auf **AUSWAHL**.

Die Funktion „AG Leiselauf“ ist nur bei Modellen verfügbar, die diese Funktion unterstützen.

2



Die aktuellen Einstellungen erscheinen.

Drücken Sie die Tasten **F1** oder **F2**, um die Einstellungen für jeden Tag der Woche aufzurufen. Drücken Sie **AUSWAHL**, um die Einstellungsanzeige aufzurufen.

Funktionseinstellungen

3



Die Anzeige, um den Flüstermodus zu aktivieren (Ja) oder deaktivieren (Nein) erscheint.

Zum Aktivieren dieser Einstellung bewegen Sie die Marke mit den Tasten **F3** oder **F4** auf „Ja“ und drücken **AUSWAHL**.

4



Der Einstellungsbildschirm für den Außengerät Leiselauf erscheint.

Um die Einstellung einzugeben oder zu ändern, bewegen Sie die Marke mit **F1** oder **F2** auf den gewünschten Wochentag und drücken die Taste **F3**, um ihn auszuwählen. (Es können mehrere Tage gewählt werden.)

Drücken Sie die **AUSWAHL**-Taste.

5

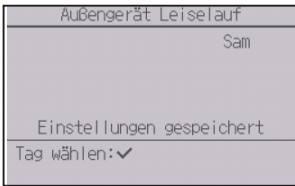

Der Einstellungsbildschirm erscheint. Bewegen Sie die Marke mit **[F1]** oder **[F2]** zum gewünschten Eintrag, Startzeit, Stoppzeit oder Leiselaufstufe.

Ändern Sie die Einstellungen mit den Tasten **[F3]** oder **[F4]**.

- Start/Stopp-Zeit: in 5-Minuten-Schritten einstellbar
* Die Taste gedrückt halten, um die Ziffern schnell zu ändern.
- Leiselaufstufe: Normal, Mittel, Leise



Drücken Sie die Taste **[AUSWAHL]**, um die Einstellungen zu speichern. Ein Bestätigungsbildschirm wird angezeigt.

Navigation durch die Bildschirme

- Zurück zur Einstellungsanzeige Wochentag ändern **[AUSWAHL]**-Taste
- Zurück zum Hauptmenü **[MENÜ]**-Taste
- Zurück zur vorhergehenden Anzeige **[ZURÜCK]**-Taste



 erscheint im Modus „AG Leiselauf“ auf dem Status- und Hauptdisplay im Komplett-Modus.

Funktionseinstellungen

Nachtabsenkung



Funktionsbeschreibung

Diese Steuerung startet den Heizbetrieb, wenn die Steuerungsgruppe abgeschaltet ist und die Raumtemperatur unter das voreingestellte untere Temperaturlimit fällt. Ebenfalls startet diese Steuerung den Kühlbetrieb, wenn die Steuerungsgruppe abgeschaltet ist und die Raumtemperatur über das voreingestellte obere Temperaturlimit steigt.

Die Nachtabsenkungsfunktion ist nicht verfügbar, wenn die Betriebs- und Temperatureinstellung von der Fernsteuerung ausgeführt wird.

Wenn die Raumtemperatur vom Ansaugtemperatursensor des Klimageräts gemessen wird, wird die Temperatur unter Umständen nicht korrekt angezeigt, falls das Klimagerät inaktiv und die Luft nicht frisch ist. In diesem Fall wechseln Sie auf einen Fernsensor (PAC-SE40TSA/PAC-SE41TS-E) oder einen ferngesteuerten Sensor.

Tastenbedienung

1



Wählen Sie „Nachtabsenkung“ aus dem Timermenü und drücken Sie auf **AUSWAHL**.

2

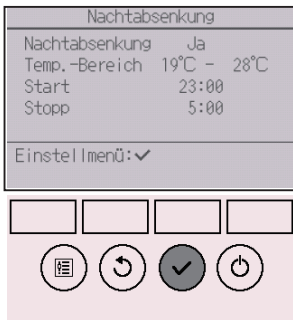

Die aktuellen Einstellungen erscheinen.

Drücken Sie **AUSWAHL**, um die Einstellungsanzeige aufzurufen.

3

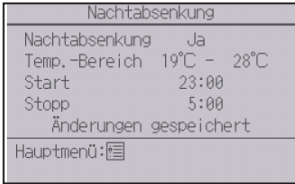

Bewegen Sie die Marke mit **[F1]** oder **[F2]** zum gewünschten Menüpunkt, Nachtabsenkung Nein (deaktiviert)/Ja (aktiviert), Temperaturbereich, Startzeit oder Stoppzeit.

Ändern Sie die Einstellungen mit den Tasten **[F3]** oder **[F4]**.

- Temp.-Bereich: Das untere Temperaturlimit (für Heizbetrieb) und das obere Temperaturlimit (für Kühlbetrieb) können hier eingestellt werden. Der Temperaturunterschied zwischen unterem und oberem Limit muss 4°C (8°F) oder mehr betragen. Der einstellbare Temperaturbereich variiert je nach angeschlossenen Innengeräteanlagen.
* 1°C-Schritte
- Start/Stopp-Zeit: in 5-Minuten-Schritten einstellbar
* Die Taste gedrückt halten, um die Ziffern schnell zu ändern.

Drücken Sie die Taste **[AUSWAHL]**, um die Einstellungen zu speichern.

Ein Bestätigungsbildschirm wird angezeigt.

Navigation durch die Bildschirme

- Zurück zum Hauptmenü **[MENÜ]**-Taste
- Zurück zur vorhergehenden Anzeige **[ZURÜCK]**-Taste

Funktionseinstellungen



 erscheint auf dem Status- und Hauptdisplay im Komplett-Modus, wenn die Nachtabsenkungsfunktion aktiviert ist.

 erscheint, wenn der Timer durch das zentrale Steuerungssystem deaktiviert wird.

Die Nachtabsenkung funktioniert in folgenden Fällen nicht:

wenn das Gerät läuft, die Nachtabsenkungsfunktion deaktiviert ist, während eines Fehlers, während einer Überprüfung (im Service-Menü), während eines Testlaufs, während einer Diagnose der Fernsteuerung, wenn die Uhr nicht eingestellt ist, während einer Funktionseinstellung, wenn das System zentralgesteuert wird („Ein/Aus“-Betrieb, Temperatureinstellung oder „Timer“-Betrieb von der lokalen Fernsteuerung ist gesperrt).

Einschränkung des Temperaturbereiches einstellen

Tastenbedienung

1

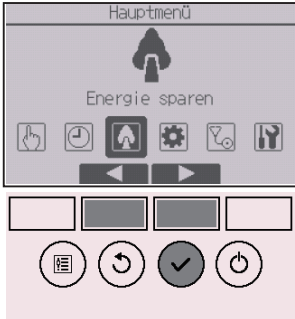

Wählen Sie „Energie sparen“ vom Hauptmenü (siehe Seite 24) und drücken Sie **AUSWAHL**.

2

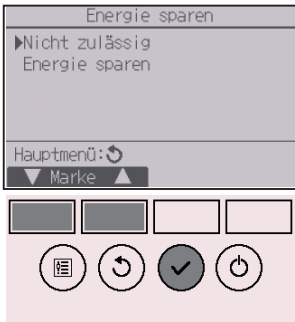

Bewegen Sie die Marke mit den Tasten **F1** oder **F2** auf „Nicht zulässig“ und drücken Sie auf **AUSWAHL**.

Funktionseinstellungen

3



Die aktuellen Einstellungen erscheinen.

Bewegen Sie die Marke mit den Tasten **F1** oder **F2** auf „Temp.-Bereich“ und drücken Sie auf **AUSWAHL**.

4

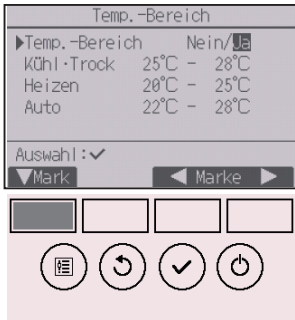

Die Anzeige, um den Temperaturbereich einzustellen erscheint.

Bewegen Sie die Marke mit **F1** zum gewünschten Menüpunkt, „Temp.-Bereich“, „Kühl-Trock“, „Heizen“ oder „Auto“.

5



Ändern Sie die Einstellungen mit den Tasten **[F3]** oder **[F4]**.

- Temp.-Bereich: Nein (unbeschränkt) oder Ja (eingeschränkt)
- Kühl•Trock: Oberes und unteres Temperaturlimit (1°C-Schritte)
- Heizen: Oberes und unteres Temperaturlimit (1°C-Schritte)
- Auto: Oberes und unteres Temperaturlimit (1°C-Schritte)

Temperatureinstellungsbereiche

Modus	Unteres Limit	Oberes Limit
Kühl•Trock *1 *3	19 ~ 30°C (67 ~ 87°F)	30 ~ 19°C (87 ~ 67°F)
Heizen *2 *3	17 ~ 28°C (63 ~ 83°F)	28 ~ 17°C (83 ~ 63°F)
Auto *4	19 ~ 28°C (67 ~ 83°F)	28 ~ 19°C (83 ~ 67°F)

* Der einstellbare Bereich variiert je nach angeschlossenem Modell.

*1 Die Temperaturbereiche für die Betriebsarten „Kühlen“, „Trocken“ und „Auto“ (Doppel-Sollwert) können eingestellt werden.

*2 Die Temperaturbereiche für die Betriebsarten „Heizen“ und „Auto“ (Doppel-Sollwert) können eingestellt werden.

*3 Die Temperaturbereiche für die Betriebsarten „Heizen“, „Kühlen“ und „Trocken“ müssen die folgenden Bedingungen erfüllen:

- Obergrenze für Kühlen - Obergrenze für Heizen \geq Mindesttemperaturdifferenz (variiert je nach Modell des Innengeräts)
- Untergrenze für Kühlen - Untergrenze für Heizen \geq Mindesttemperaturdifferenz (variiert je nach Modell des Innengeräts)

*4 Der Temperaturbereich für den Modus „Auto“ (Einzel-Sollwert) kann eingestellt werden.

Drücken Sie die Taste **[AUSWAHL]**, um die Einstellungen zu speichern.

Ein Bestätigungsbildschirm wird angezeigt.

Navigation durch die Bildschirme

- Zurück zum Hauptmenü **[MENÜ]**-Taste
- Zurück zur vorhergehenden Anzeige **[ZURÜCK]**-Taste

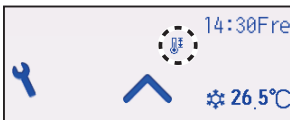

 erscheint auf dem Status- und Hauptdisplay im Komplett-Modus, wenn der Temperaturbereich eingeschränkt ist.

Funktionseinstellungen

Nicht zulässig



Betriebssperrfunktion

Tastenbedienung

Um die Betriebssperrfunktion zu aktivieren, muss der Menüpunkt „Bedien. gesperrt“ auf „Ja“ gestellt sein.

1



Öffnen Sie den Bildschirm für die Einschränkungen Einstellung. (siehe Seite 43.)

Bewegen Sie die Marke auf „Bedien. gesperrt“ und drücken **AUSWAHL**.

2

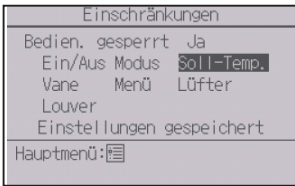

Die Anzeige, um die Einstellungen für die Betriebssperrfunktion vorzunehmen erscheint.

Bewegen Sie die Marke mit **[F1]** oder **[F2]** zum gewünschten Menüpunkt, „Bedien. gesperrt“, „Standort“, „Ein/Aus“, „Modus“, „Soll-Temp.“, „Menü“, „Lüfter“, „Louver“ oder „Vane“.

Ändern Sie die Einstellungen mit den Tasten **[F3]** oder **[F4]**.

- Bedien. gesperrt: Nein (deaktiviert)/Ja (aktiviert)
 - Standort: „Indiv.“ oder „Hotel“
 - Ein/Aus: Ein/Aus Betrieb
 - Modus: Betriebsarteneinstellung
 - Soll-Temp.: Temperaturvoreinstellungen
 - Vane: Vane-Einstellung
 - Menü: Menüeinstellung
 - Lüfter: Lüfterdrehzahleinstellung
 - Louver: Louver-Einstellung
-] „-“ / „Gesperrt“

Wenn unter „Standort“ die Option „Hotel“ ausgewählt ist, werden die folgenden Operationen automatisch verriegelt: Modus, Vane, Menü und Louver.

Drücken Sie die Taste **[AUSWAHL]**, um die Einstellungen zu speichern.

Ein Bestätigungsbildschirm wird angezeigt.

Navigation durch die Bildschirme

- Zurück zum Hauptmenü **[MENÜ]**-Taste
- Zurück zur vorhergehenden Anzeige **[ZURÜCK]**-Taste

Funktionseinstellungen



 erscheint auf dem Status- und Hauptdisplay im Komplett-Modus, wenn die Funktion „Bedienung gesperrt“ aktiviert ist.

Bedienungsanleitungen für gesperrte Funktionen werden unterdrückt.

Zur Anzeige des Hauptmenüs bei gesperrter Menüeinstellung müssen Sie die **Einstellung**-Taste mindestens 10 Sekunden lang gedrückt halten. Geben Sie im Passwort-Eingabebildschirm das Administrator-Passwort ein.

Automatische Rückstellung auf die voreingestellte Temperatur

Nachdem die Auto Zurück-Funktion aktiviert wurde, wenn der Betriebsmodus Ändern oder der EIN/AUS Betrieb von dieser Fernsteuerung aus ausgeführt wird, kehrt die eingestellte Temperatur automatisch auf die erforderliche Temperatur zurück, unabhängig von der eingestellten Zeit.

Tastenbedienung

- 1 Wählen Sie aus dem Energiesparmenü „Energie sparen“ und drücken Sie auf **AUSWAHL**.



- 2 Die aktuellen Einstellungen erscheinen.
- Bewegen Sie die Marke mit den Tasten **F1** oder **F2** auf „Auto Zurück“ und drücken Sie auf **AUSWAHL**.

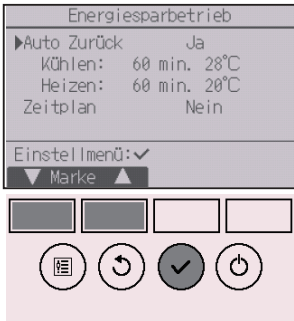

Funktionseinstellungen

3



Die Anzeige, um die Einstellungen für die automatische Rückstellung vorzunehmen erscheint.

Bewegen Sie die Marke mit [F1] oder [F2] zum gewünschten Menüpunkt, „Auto Zurück“, „Kühlen“ oder „Heizen“.

4



Ändern Sie die Einstellungen mit den Tasten [F3] oder [F4].

- Auto Zurück: Nein (deaktiviert)/Ja (aktiviert)
- Kühlen: Der Zeiteinstellbereich kann in 10-Minuten-Schritten zwischen 30 und 120 Minuten eingestellt werden. Der Temperatureinstellbereich ist 19 bis 30°C (67 bis 87°F) (1°C-Schritte).
- Heizen: Der Zeiteinstellbereich kann in 10-Minuten-Schritten zwischen 30 und 120 Minuten eingestellt werden. Der Temperatureinstellbereich ist 17 bis 28°C (63 bis 83°F) (1°C-Schritte).

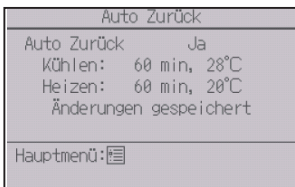

Drücken Sie die Taste [AUSWAHL], um die Einstellungen zu speichern. „Kühlen“ beinhaltet den Modus „Trocken“ und „Auto Kühlen“, „Heizen“ beinhaltet den Modus „Auto Heizen“.

Die Anzeige, um das ausgewählte Objekt einzustellen erscheint.

Navigation durch die Bildschirme

- Zurück zum Hauptmenü [MENÜ]-Taste
- Zurück zur vorhergehenden Anzeige [ZURÜCK]-Taste

Die „Timer“- oder Temperaturvoreinstellungen werden nicht wirksam, wenn der Temp.-Bereich eingeschränkt ist und wenn das System zentral gesteuert wird (wenn die Temperaturbereichseinstellung von der lokalen Fernbedienung gesperrt ist). Wenn das System zentral gesteuert wird (wenn der „Timer“-Betrieb von der lokalen Fernsteuerung gesperrt ist), wird nur die „Timer“-Einstellung unwirksam.

Zeitplan für Energiesparbetrieb einstellen

Tastenbedienung

1



Öffnen Sie den Bildschirm „Energie sparen“. (siehe Seite 49.)

Bewegen Sie die Marke auf „Zeitplan“ und drücken Sie die **AUSWAHL**-Taste.

2



Die Anzeige, um den Zeitplaner einzustellen erscheint.

Drücken Sie die Tasten **F1** oder **F2**, um die Einstellungen für jeden Tag der Woche aufzurufen. Drücken Sie **AUSWAHL**, um die Einstellungsanzeige aufzurufen.

3



Die Anzeige, um den Zeitplan für den Energiesparbetrieb zu aktivieren (Ja) oder deaktivieren (Nein) erscheint.

Wählen Sie mit **F3** oder **F4** „Nein“ oder „Ja“. Drücken Sie **AUSWAHL**, um die Einstellungsanzeige Wochentag ändern aufzurufen.

Funktionseinstellungen

4



Die Auswahlanzeige „Wochentag ändern“ erscheint. Bis zu vier Betriebszeiten können pro Tag eingestellt werden.

Bewegen Sie die Marke mit den Tasten **F1** oder **F2** auf den gewünschten Wochentag und drücken Sie die **F3**-Taste. (Es können mehrere Tage gewählt werden.)

Drücken Sie **AUSWAHL**, um die Betriebszeitenanzeige aufzurufen.

5



Der Einstellungsbildschirm erscheint.

Drücken Sie **F1**, um die Marke zur gewünschten Nummer zu bewegen.

Bewegen Sie die Marke mit **F2** zur gewünschten Stelle, Startzeit, Stoppzeit und Energiesparrate (in dieser Reihenfolge von links nach rechts).

Ändern Sie die Einstellungen mit den Tasten **F3** oder **F4**.

- Start/Stopp-Zeit: in 5-Minuten-Schritten einstellbar
- * Die Taste gedrückt halten, um die Ziffern schnell zu ändern.
- Energiesparrate: Einstellbereich: 0% und 50 bis 90% in 10%-Schritten.

Drücken Sie die Taste **AUSWAHL**, um die Einstellungen zu speichern.

Ein Bestätigungsbildschirm wird angezeigt.

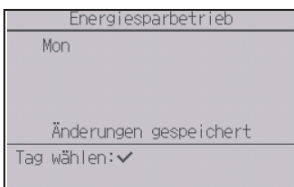

Je niedriger der Wert, desto höher der Energiespareffekt.



 erscheint auf dem Status- und Hauptdisplay im Komplett-Modus, wenn die Anlage im Energiesparmodus betrieben wird.

Navigation durch die Bildschirme

- Zurück zur Einstellungsanzeige Wochentag ändern **AUSWAHL**-Taste
- Zurück zum Hauptmenü **MENÜ**-Taste
- Zurück zur vorhergehenden Anzeige **ZURÜCK**-Taste

Funktionseinstellungen

Uhr

P

Tastenbedienung

1



Wählen Sie aus dem Hauptmenü „Grundeinstellungen“ (siehe Seite 24) und drücken Sie **AUSWAHL**.

Bevor folgende Einstellungen gemacht werden können muss die Uhr eingestellt werden.

- Ein/Aus-Timer
- Wochentimer
- AG Leiselauf
- Energiesparbetrieb
- Nachtabsenkung

Wenn ein System über keine Systemsteuerungen verfügt, wird die Uhr nicht automatisch korrigiert. Korrigieren Sie die Uhrzeit in diesem Fall regelmäßig.

2



Bewegen Sie die Marke mit den Tasten **F1** oder **F2** auf „Grundeinstellung“ und drücken Sie auf **AUSWAHL**.

3



Wählen Sie „Uhr“ mit den Tasten **F1** oder **F2** und drücken Sie **AUSWAHL**.

4



Bewegen Sie die Marke mit den Tasten **F1** oder **F2** auf „Uhr“ und drücken Sie auf **AUSWAHL**.

5



Bewegen Sie die Marke mit **F1** oder **F2** zum gewünschten Eintrag, Jahr, Monat, Tag, Stunde, oder Minute.

Erhöhen oder verringern Sie den Wert für den gewählten Eintrag mit **F3** oder **F4** und drücken Sie **AUSWAHL**.

Ein Bestätigungsbildschirm wird angezeigt.

Navigation durch die Bildschirme

- Zurück zum Hauptmenü **MENÜ**-Taste
- Zurück zum vorhergehenden Bildschirm **ZURÜCK**-Taste

Funktionseinstellungen

Sommerzeit



Funktionsbeschreibung

Die Startzeit/Endzeit der Sommerzeit kann eingestellt werden. Die Sommerzeitfunktion wird anhand der konfigurierten Einstellungen aktiviert.

- Wenn ein System über eine Systemsteuerung verfügt, muss diese Einstellung deaktiviert werden, um die korrekte Uhrzeit beizubehalten.
- Zu Beginn und am Ende der Sommerzeit wird der Timer eventuell zwei oder kein Mal aktiv.
- Diese Funktion funktioniert nur, wenn die Uhr eingestellt worden ist.

Tastenbedienung

1



Wählen Sie aus dem Menü „Grundeinstellung“ „Uhr“ und drücken Sie auf **AUSWAHL**.

2



Bewegen Sie die Marke mit den Tasten **F1** oder **F2** auf „Sommerzeit“ und drücken Sie auf **AUSWAHL**.

3

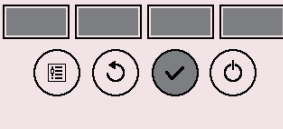

Bewegen Sie die Marke mit der **[F1]**-Taste zu den folgenden Elementen, um die Einstellung vorzunehmen.

- Sommerzeit
Wählen Sie mit der **[F2]**-Taste „Nein“ (deaktivieren) oder „Ja“ (aktivieren) . Die Standardeinstellung ist „Nein“.
- Datum(Start)*¹
Stellen Sie mit den Tasten **[F3]** oder **[F4]** den Wochentag, die Wochennummer und den Monat ein. Die Standardeinstellung ist „Son/5./Mär“.
- Startzeit
Stellen Sie mit den Tasten **[F3]** oder **[F4]** die Startzeit der Sommerzeit ein.
- Vorstellen
Legen Sie mit den Tasten **[F3]** oder **[F4]** die Uhrzeit fest, an der an der oben genannten Startzeit die Uhrzeit vorgestellt werden soll.
- Datum(Ende)*¹ (2. Seite)
Stellen Sie mit den Tasten **[F3]** oder **[F4]** den Wochentag, die Wochennummer und den Monat ein. Die Standardeinstellung ist „Son/5./Okt“.
- Endzeit (2. Seite)
Stellen Sie mit den Tasten **[F3]** oder **[F4]** die Endzeit der Sommerzeit ein.
- Zurückstellen (2. Seite)
Legen Sie mit den Tasten **[F3]** oder **[F4]** die Uhrzeit fest, an der an der oben genannten Endzeit die Uhrzeit zurückgestellt werden soll.

*1 Wenn „5.“ für die Wochennummer ausgewählt ist, es für den ausgewählten Monat des Jahres jedoch keine 5. Woche gibt, wird die Einstellung als „4.“ Woche gehandhabt.

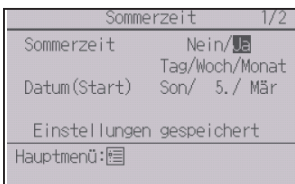

Drücken Sie die Taste **[AUSWAHL]**, um die Einstellungen zu speichern.
Ein Bestätigungsbildschirm wird angezeigt.

Navigation durch die Bildschirme

- Zurück zum Hauptmenü **[MENÜ]**-Taste
- Zurück zur vorhergehenden Anzeige **[ZURÜCK]**-Taste

Funktionseinstellungen

Hauptdisplay



Tastenbedienung

1

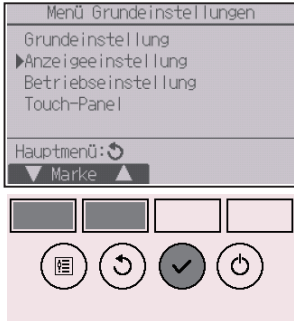

Wählen Sie aus dem Menü „Grundeinstellungen“ „Anzeigeeinstellung“ und drücken Sie auf **AUSWAHL**.

2



Bewegen Sie die Marke mit den Tasten **F1** oder **F2** auf „Hauptdisplay“ und drücken Sie auf **AUSWAHL**.

3



Wählen Sie mit **F3** oder **F4** „Komplett“ oder „Einfach“ (siehe Seite 10) und drücken **AUSWAHL**.

Ein Bestätigungsbildschirm wird angezeigt.

Navigation durch die Bildschirme

- Zurück zum Hauptmenü **MENÜ**-Taste
- Zurück zur vorhergehenden Anzeige **ZURÜCK**-Taste

Tastenbedienung

1

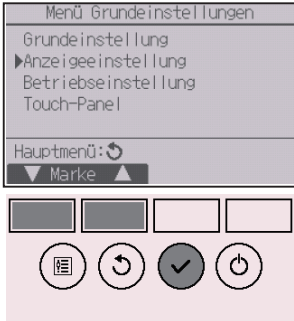

Wählen Sie aus dem Menü „Grundeinstellungen“ „Anzeige-einstellung“ und drücken Sie auf **AUSWAHL**.

2



Bewegen Sie die Marke mit den Tasten **F1** oder **F2** auf „Hauptdisplay“ und drücken Sie auf **AUSWAHL**.

3



Mit den Tasten **F1** oder **F2** „Symbolbeschrei.“ wählen, mit den Tasten **F3** oder **F4** die gewünschte Einstellung „Ja“ oder „Nein“ wählen und dann **AUSWAHL** drücken.

Die Standardeinstellung ist „Ja“.

Navigation durch die Bildschirme

- Zurück zum Hauptmenü **MENÜ**-Taste
- Zurück zur vorhergehenden Anzeige **ZURÜCK**-Taste

Funktionseinstellungen

4

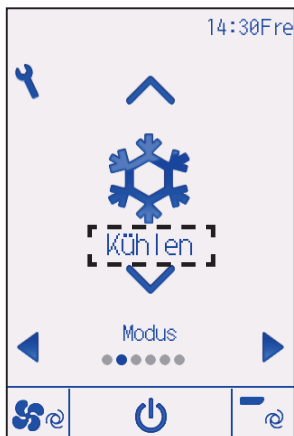

Bei Auswahl von „Ja“ erscheint die Erklärung des Symbols der jeweiligen Einstellung wie unten dargestellt.

Tastenbedienung

1

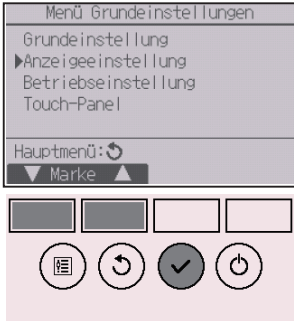

Wählen Sie aus dem Menü „Grundeinstellungen“ „Anzeigeeinstellung“ und drücken Sie auf **AUSWAHL**.

2



Bewegen Sie die Marke mit den Tasten **F1** oder **F2** auf „Helligkeit“ und drücken Sie auf **AUSWAHL**.

3



Die Helligkeit lässt sich mit den Tasten **F1** oder **F2** einstellen.

Für die Einstellung „Beleuchtet“ kann mit **F4** „EIN“ oder „AUS“ gewählt werden.

Wenn „EIN“ gewählt wird, leuchtet das Hintergrundlicht auch dann noch leicht, wenn die angegebene Zeit abgelaufen ist.

Navigation durch die Bildschirme

- Zurück zum Hauptmenü **MENÜ**-Taste
- Zurück zur vorhergehenden Anzeige **ZURÜCK**-Taste

Funktionseinstellungen

Sprachauswahl



Funktionsbeschreibung

Die gewünschte Sprache kann eingestellt werden. Mögliche Sprachen sind deutsch, englisch, französisch, spanisch, italienisch, portugiesisch, schwedisch, russisch, griechisch, türkisch, niederländisch, tschechisch, ungarisch und polnisch.

Tastenbedienung

1



Wählen Sie aus dem Menü „Grundeinstellungen“ „Anzeigeeinstellung“ und drücken Sie auf **AUSWAHL**.

2



Bewegen Sie die Marke mit den Tasten **F1** oder **F2** auf „Sprachauswahl“ und drücken Sie auf **AUSWAHL**.

3

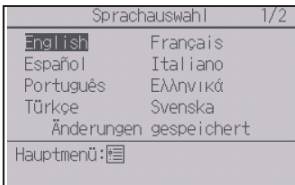
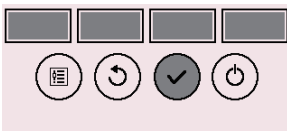
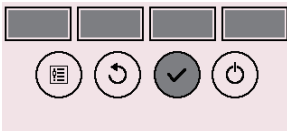

Bewegen Sie die Marke mit den Tasten **F1** bis **F4** auf die gewünschte Sprache und drücken Sie **AUSWAHL**, um die Sprache zu speichern.

Beim erstmaligen Einschalten der Stromversorgung wird der Bildschirm für die Sprachauswahl angezeigt. Wählen Sie die gewünschte Sprache aus. Das System startet erst, wenn die Sprachauswahl erfolgt ist.

Ein Bildschirm zeigt an, dass die Einstellungen gespeichert wurden.

Navigation durch die Bildschirme

- Zurück zum Hauptmenü **MENÜ**-Taste
- Zurück zur vorhergehenden Anzeige **ZURÜCK**-Taste

Funktionseinstellungen

Design



Tastenbedienung

1

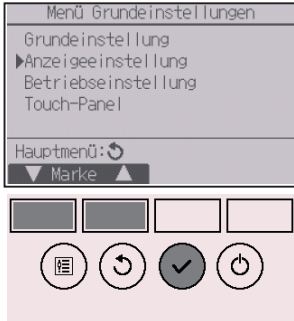

Wählen Sie aus dem Menü „Grundeinstellungen“ „Anzeigeeinstellung“ und drücken Sie auf **AUSWAHL**.

2



Bewegen Sie die Marke mit den Tasten **F1** oder **F2** auf „Design“ und drücken Sie auf **AUSWAHL**.

3



Wählen Sie mit **F4** „Farbe“.

- Farbe: Die Display-Farbe kann gewählt werden. (Siehe nächste Seite.)
- Weiß: Monochrom-Display (weißer Hintergrund)
- Schwarz: Monochrom-Display (schwarzer Hintergrund)

Drücken Sie **AUSWAHL**, wenn „Weiß“ oder „Schwarz“ ausgewählt ist. Bei Auswahl von „Farbe“ ist die gewünschte Farbe gemäß der Anleitung auf der nächsten Seite auszuwählen.

4



Wählen Sie mit den Tasten **[F1]** oder **[F2]** das folgende Element und stellen Sie für jedes Element die gewünschte Farbe ein.

- Farbschattierung: Die Farbschattierung lässt sich mit den Tasten **[F3]** oder **[F4]** einstellen. (Der einstellbare Bereich geht von -90 bis 89.)
- Muster: Stellen Sie die mit **[F4]** die Farbe ein.
- Farbe änd. zu: Wählen Sie mit **[F4]** „Zeichen“ oder „Hintergrund,“ je nachdem, für welche Schaltflächenkomponente die betreffende Farbe gelten soll.

Die Musterfarbe unter den Funktionstasten ändert sich je nach Einstellung.

Wählen Sie die gewünschte Farbe aus und drücken Sie auf **[AUSWAHL]**.

Navigation durch die Bildschirme

- Zurück zum Hauptmenü **[MENÜ]**-Taste
- Zurück zum vorhergehenden Bildschirm **[ZURÜCK]**-Taste

Funktionseinstellungen

Touch-Panel-Kalibrierung



Tastenbedienung

1



Wählen Sie aus dem Menü „Grundeinstellungen“ „Touch-Panel“ und drücken Sie auf **AUSWAHL**.

2



Bewegen Sie die Marke mit den Tasten **F1** oder **F2** auf „Touch-Panel-Kalibrierung“ und drücken Sie auf **AUSWAHL**.

3



Ein Bestätigungsbildschirm wird angezeigt. Wählen Sie mit den Tasten **F3** oder **F4** „Abbr.“ oder „OK“ und drücken Sie **AUSWAHL**.

4

Berühren Sie die schwarzen Punkte in der Reihenfolge, wie sie auf dem Bildschirm angezeigt werden. Insgesamt gibt es 9.

Berühren Sie die schwarzen Punkte mit einem Touch-Pen in einer Minute ausgehend von der oberen linken Ecke

Berühren Sie die neun schwarzen Punkte in der Reihenfolge, wie sie auf dem Bildschirm erscheinen. Wenn alle neun schwarzen Punkte berührt wurden, ist die Kalibrierung abgeschlossen, und das Display schaltet wieder in das Touch-Panel-Menü zurück.

- Wenn das Touch-Panel eine Minute lang nicht berührt wurde, wird die Kalibrierung abgebrochen und das Display kehrt automatisch zum vorherigen Bildschirm zurück.
- Zum ordnungsgemäßen Kalibrieren ist das Touch-Panel an den jeweiligen Punkten mit einem spitzen Gegenstand zu berühren, der aber nicht scharf sein darf.
 - * Scharfe Gegenstände können Kratzer auf dem Touch-Panel verursachen oder dieses sogar beschädigen.

Funktionseinstellungen

Touch-Panel-Reinigung



Tastenbedienung

1



Wählen Sie aus dem Menü „Grundeinstellungen“ „Touch-Panel“ und drücken Sie auf **AUSWAHL**.

2



Bewegen Sie die Marke mit den Tasten **F1** oder **F2** auf „Touch-Panel-Reinigung“ und drücken Sie auf **AUSWAHL**.

3



Ein Bestätigungsbildschirm wird angezeigt. Wählen Sie mit den Tasten **F3** oder **F4** „Abbr.“ oder „OK“ und drücken Sie **AUSWAHL**.

4

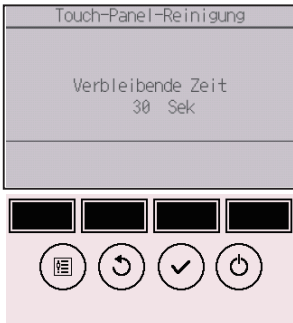

Dieser Bildschirm ermöglicht es dem Benutzer, das Touch-Panel 30 Sekunden lang abzuwischen, ohne dass es auf Eingaben reagiert und Einstellungen versehentlich geändert werden.

Das Display schaltet nach 30 Sekunden in das Touch-Panel-Menü zurück.

- Mit einem trockenen, weichen Tuch, einem in Wasser getränkten Tuch mit einem milden Reinigungsmittel oder einem leicht mit Ethanol angefeuchteten weichen Tuch abwischen. Keine säurehaltige, alkalische oder organische Lösungsmittel verwenden.

Funktionseinstellungen

Fernbedienung zurücksetzen



Funktionsbeschreibung

Die Fernsteuerung lässt sich auf die Werkseinstellungen zurücksetzen. Beachten Sie, dass die folgenden Daten initialisiert werden.

Die Fernsteuerung wird nach der Initialisierung automatisch gestartet.

Einstellungen für Timer, Wochentimer, Außengerät Leiselauf, Energiesparbetrieb, Energiesparoption, Uhr, Sommerzeit, Hauptdisplay, Helligkeit, Displaydetails, Design, Automatik, Modellname, Seriennummer, Händlerinformationen, Störungsinformationen, Administrator-Passwort, Wartungspasswort

Tastenbedienung

1



Wählen Sie aus dem Service-Menü „Sonstiges“ und drücken Sie auf **AUSWAHL**.

2



Bewegen Sie die Marke mit den Tasten **F1** oder **F2** auf „Fernbedienung zurücksetzen“ und drücken Sie auf **AUSWAHL**.

3

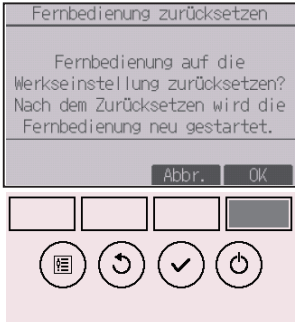

Wählen Sie mit **[F4]** „OK“.

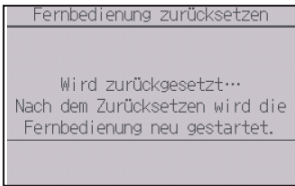

Die Fernsteuerung wird nach der Initialisierung automatisch gestartet.

Funktionseinstellungen

Fernbedienungsinformation



Funktionsbeschreibung

Die Informationen der in Verwendung befindlichen Fernsteuerung lassen sich kontrollieren.

Tastenbedienung

1



Wählen Sie aus dem Service-Menü „Sonstiges“ und drücken Sie auf **AUSWAHL**.

2



Bewegen Sie die Marke mit den Tasten **F1** oder **F2** auf „Fernbedienungsinformation“ und drücken Sie auf **AUSWAHL**.

3

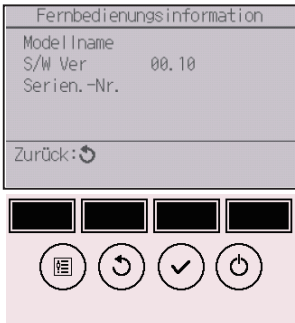

Modellname, Softwareversion und Seriennummer der in Verwendung befindlichen Fernsteuerung werden angezeigt.

Fehlerbehebung

Störungsinformation

Bei Auftreten einer Störung wird der folgende Bildschirm angezeigt, und die Betriebs-LED blinkt. Überprüfen Sie die Fehlermeldung, stoppen Sie den Betrieb und kontaktieren Sie Ihren Lieferanten.

Tastenbedienung

1



Fehlercode, das die Störung verursachende Gerät, Kältemitteladresse, Gerätemodellname und die Seriennummer werden angezeigt. Der Modellname und die Seriennummer erscheinen nur, wenn sie vorher eingegeben wurden.

Drücken Sie **F1** oder **F2**, um die nächste Seite anzuzeigen.



Kontaktinformationen (Telefonnummer des Lieferanten) erscheinen, wenn sie vorher eingegeben wurden.

2



Drücken Sie die Tasten **[F4]** oder **[EIN/AUS]**, um den aufgetretenen Fehler zurück zu setzen.

Fehler können nicht zurückgesetzt werden, wenn der EIN/AUS Betrieb untersagt ist.

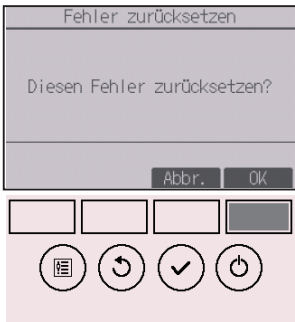

Wählen Sie mit **[F4]** „OK“.

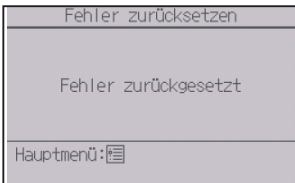

Ein Bestätigungsbildschirm wird angezeigt.

Navigation durch die Bildschirme

- Zurück zum Hauptmenü **[MENÜ]**-Taste

Fehlerbehebung

Fehlerinformationen kontrollieren



Wenn keine Fehler auftreten, kann aus dem Menübetrieb heraus Seite 2/2 der Fehlermeldungen (siehe Seite 74) angezeigt werden.

Wählen Sie aus dem Hauptmenü „Wartungsmenü“ und drücken Sie auf **AUSWAHL**.

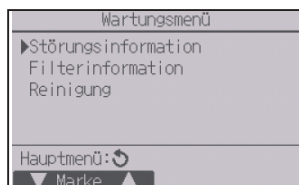

Zum Anzeigen von Störungsinformationen wählen Sie aus dem Wartungsmenü „Störungsinformation“. Fehler lassen sich nicht zurücksetzen.

Abschaltautomatik Keine Anwesenheit

Der folgende Bildschirm erscheint für das 3D i-See sensor Panel-Modell, wenn das Gerät aufgrund der Abschaltautomatik Keine Anwesenheit. Funktion der Energiesparoption angehalten wird. Informationen für die 3D i-See Sensor-Einstellung finden Sie im Anweisungshandbuch der Innengeräteanlage.

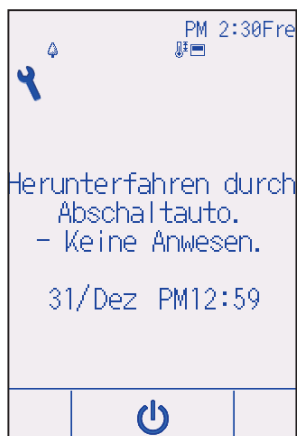

Wartung

Filterinformationen

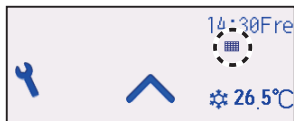

 erscheint auf dem Status- und Hauptdisplay im Komplett-Modus, wenn der Filter gereinigt werden muss.

**Waschen, reinigen oder ersetzen Sie den Filter, wenn dieses Symbol erscheint.
Siehe Betriebsanleitung der Innengeräteanlage.**

Tastenbedienung

1



Wählen Sie aus dem Wartungsmenü „Filterinformation“ und drücken Sie auf **AUSWAHL**.

2



Drücken Sie **F4**, um das Filtersymbol zurück zu setzen.

Hinweise zur Filterreinigung finden Sie in der Betriebsanleitung der Innengeräteanlage.

3

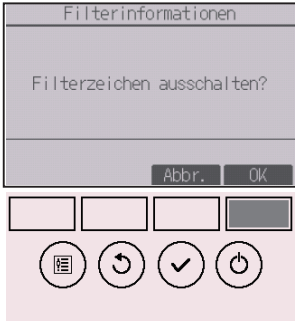

Wählen Sie mit **[F4]** „OK“.

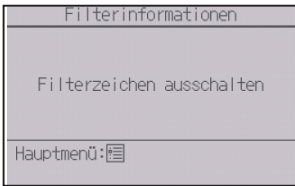



Ein Bestätigungsbildschirm wird angezeigt.

Navigation durch die Bildschirme

- Zurück zum Hauptmenü **MENÜ**-Taste
- Zurück zur vorhergehenden Anzeige **ZURÜCK**-Taste



Wenn im Komplett-Modus im Status- und Hauptdisplay  erscheint, wird das System zentralgesteuert und das Filtersymbol kann nicht zurückgesetzt werden.

Wenn zwei oder mehr Innengeräteanlagen angeschlossen sind, kann die Filterreinigungsperiode je nach Filtertyp unterschiedlich sein.
Das Symbol  erscheint, wenn der Filter der Hauptanlage gereinigt werden muss.
Wenn das Filtersymbol zurückgesetzt wird, wird die Gesamtbetriebszeit aller Anlagen zurückgesetzt.

Das Symbol  erscheint planungsgemäß nach einer bestimmten Betriebszeit, je nach dem Gebäude, in dem die Innengeräteanlagen bei normaler Luftqualität installiert sind. Je nach Luftqualität, muss der Filter unter Umständen öfter gereinigt werden.

Die Gesamtzeit, bei der ein Filter gereinigt werden muss, ist abhängig vom Modell.

Technische Daten

Technische Daten Steuerung

	Beschreibung
Gerätegröße	Standard (PAR-CT01MAA(R)-SB/PAR-CT01MAA-S): 65(B) × 120(H) × 14,1(T) mm (2 9/16 × 4 23/32 × 9/16 [in]) (ohne überstehende Teile)
	Premium (PAR-CT01MAA(R)-PB): 68(B) × 120(H) × 14,1(T) mm (2 11/16 × 4 23/32 × 9/16 [in]) (ohne überstehende Teile)
Nettogewicht	Standard (PAR-CT01MAA(R)-SB/PAR-CT01MAA-S): 0,09 kg (13/64 lbs)
	Premium (PAR-CT01MAA(R)-PB): 0,10 kg (7/32 lbs)
Versorgungsspannung	12 VDC (aus Innengeräteanlagen gespeist)
Stromverbrauch	0,6 W
Betriebsumgebung	Temperatur 0 ~ 40°C (32 ~ 104°F) Feuchtigkeit 25 ~ 90% RH (ohne Taubildung)
Material	Standard (PAR-CT01MAA(R)-SB/PAR-CT01MAA-S) Hauptgehäuse: ABS
	Premium (PAR-CT01MAA(R)-PB) Hauptgehäuse: ABS Seitenplatte: Aluminium

Funktionsliste (Stand: 1. Oktober 2017)

○ : Unterstützt × : Nicht unterstützt

	Funktion	CITY MULTI	Mr. SLIM	Passwort erforderlich
Stromversorgungs-	EIN/AUS-Schalter	○	○	-
Einstellungen	Betriebsart	○	○	-
	Modus „Auto“ (Doppel-Sollwert)	○	○	-
	Voreingestellte Temperatur	○	○	-
	Lüfterdrehzahl	○	○	-
	Vane	○	○	-
	Louver	○	○	-
	Ventilation	○	○	-
Menü „Richtung“	Hohe Leistung	×	○	-
	Manueller Vane	○	○	-
	3D i-See sensor	○	○	-
Timer-Menü	Timer (Ein/Aus-Timer)	○	○	administrator
	Timer (Ausschalt-Timer)	○	○	administrator
	Wochentimer	○	○	administrator
	Außengerät Leiselauf	○	○	administrator
	Nachtabsenkung	○	○	administrator
Energiesparmenü	Temperaturbereichseinschränkung	○	○	administrator
	Betriebssperrfunktion	○	○	administrator
	Auto Zurück	○	○	administrator
	Zeitplan	×	○	administrator
Menü Grundeinstellungen	Uhr	○	○	administrator
	Formateinstellungsanzeige Uhr	○	○	administrator
	Sommerzeit	○	○	administrator
	Hauptdisplay	○	○	administrator
	Symbolbeschreibungen	○	○	administrator
	Helligkeit	○	○	administrator
	Sprachauswahl	○	○	administrator
	Design	○	○	administrator
	Touch-Panel-Kalibrierung	○	○	administrator
	Touch-Panel-Reinigung	○	○	administrator
Passwort (Administrator)	○	○	administrator	
Service-Menü	Fernbedienung zurücksetzen	○	○	wartung
	Fernbedienungsinformation	○	○	wartung
	Testlauf	○	○	wartung
	Modellinformationseingabe	○	○	wartung
	Lieferanteninformationseingabe	○	○	wartung
	Funktionseinstellung	○	○	wartung
	Sanfte Wartung	×	○	wartung
	Passwort (Wartung)	○	○	wartung
Wartungsmenü	Filter-Lift-Blende	○	○	-
	Störungsinformation	○	○	-
	Filterinformationen	○	○	-

* Unterstützte Funktionen variieren je nach Anlagenmodell.

Technische Daten

werden können

	Hohe Leistung	Ein/Aus-Timer	Ausschalt-Timer	Wochentimer	Außengerät Leiselauf	Temperaturbereich	Bedienung gesperrt	Auto Zurück	Energiesparplan	Nachtabsenkung
Hohe Leistung		○	○	○	△ 1	○	△ 2	○	△ 1	○
Ein/Aus-Timer	○		○	× 1	○	○	○	○	○	△ 3
Ausschalt-Timer	○	○		○	○	○	○	○	○	△ 4
Wochentimer	○	× 1	○		○	○	○	○	○	△ 5
Außengerät Leiselauf	△ 1	○	○	○		○	○	○	○	○
Temperaturbereich	○	○	○	○	○		○	× 2	○	△ 6
Bedienung gesperrt	△ 2	○	○	○	○	○		○	○	○
Auto Zurück	○	○	○	○	○	× 2	○		○	△ 7
Energiesparplan	△ 1	○	○	○	○	○	○	○		○
Nachtabsenkung	○	△ 3	△ 4	△ 5	○	△ 6	○	△ 7	○	

○ : Kann in Kombination genutzt werden × : Kann nicht in Kombination genutzt werden △ : Eingeschränkt

- △ 1: Diese Funktion wird nach dem Hochleistungsbetrieb aktiviert, da der Hochleistungsbetrieb die höhere Priorität besitzt.
- △ 2: Diese Funktion kann nicht aktiviert werden, wenn einige Bedienungen gesperrt sind.
- △ 3: Die Nachtabsenkungsfunktion kann nicht benutzt werden, wenn die Anlage durch eine EIN/AUS Zeitschaltung betrieben wird.
- △ 4: Die „Auto Aus“ Funktion kann nicht für die Nachtabsenkung benutzt werden.
- △ 5: Die Nachtabsenkungsfunktion kann nicht benutzt werden, wenn die Anlage durch eine Wochenzeitschaltung betrieben wird.
- △ 6: Die Temperaturbereichseinstellung kann nicht für die Nachtabsenkung benutzt werden.
- △ 7: Die Auto-Zurück Funktion kann nicht für die Nachtabsenkung benutzt werden.

- × 1: Die Einstellung für die Wochenzeitschaltung ist nicht aktiv, da die EIN/AUS Zeitschaltung eine höhere Priorität hat.
- × 2: Die Auto-Zurück Funktion kann nicht benutzt werden, da die Temperaturbereichseinstellung eine höhere Priorität hat.

CITY MULTI Besturingssysteem
en Mitsubishi Mr. SLIM Airconditioners

MA Touch afstandsbediening

PAR-CT01MAA-PB

PAR-CT01MAA-SB

PAR-CT01MAA-S

PAR-CT01MAR-PB

PAR-CT01MAR-SB

Bedieningshandleiding



Nederlands

Lees, voordat u het product in gebruik neemt, de instructies in deze handleiding aandachtig door zodat u het product op juiste wijze kunt gebruiken.

Bewaar deze handleiding zodat u deze later ook nog kunt raadplegen.

Het is belangrijk dat deze CD-ROM en de Installatiehandleiding worden doorgegeven aan eventuele toekomstige gebruikers.



De afstandsbediening mag alleen door gekwalificeerd personeel worden geïnstalleerd, zodat zeker is dat de afstandsbediening veilig en goed werkt.

Inhoud

Voorzorgsmaatregelen	4
Onderdelen van de afstandsbediening	6
Interface van de afstandsbediening - Statusdisplay/Hoofddisplay	6
Interface van de afstandsbediening - menuscherm	8
Display - Statusdisplay/Hoofddisplay	10
Menustructuur en pictogrammen	12
Menustructuur	12
Uitleg over pictogrammen	15
Basis bedieningshandelingen	16
AAN/UIT	16
Instellingen voor bedieningsmodus, temperatuur, ventilatorsnelheid, waaier, lamel en ventilatie (Lossnay)	17
Navigeren door het menu	22
Hoofdmenulijst	22
Navigeren door het Hoofdmenu	24
Functie-instellingen	25
Hoog vermogen	25
Handmatige hoek waaier	26
Timer (Aan/uit-timer)	29
Timer (Auto-uit-timer)	32
Weekklok	34
Stille stand buitenunit	37
Nachtverlaging	40
Beperking	43
Energiebesparing	49
Klok	54
Zomertijd	56
Hoofddisplay	58
Uitleg over pictogrammen	59
Helderheid	61
Taalkeuze	62
Ontwerp	64
Aanraakpaneel kalibratie	66
Aanraakpaneel reinigen	68
Afstandsbediening initialiseren	70
Informatie afstandsbediening	72
Oplossen van problemen	74
Informatie over fout	74
Auto-UIT bij afwezigheid	77
Onderhoud	78
Informatie over filter	78
Specificaties	80
Specificaties afstandsbediening	80
Functielijst (stand 1 oktober 2017)	81
Lijst van functies die in combinatie/niet in combinatie kunnen worden gebruikt	82

Voorzorgsmaatregelen

- Lees de volgende veiligheidsmaatregelen aandachtig door voordat u de unit in gebruik neemt.
- Leef deze voorzorgsmaatregelen nauwkeurig na voor de veiligheid.

 WAARSCHUWING	Geeft aan dat er een risico op ernstig of dodelijk letsel bestaat.
 LET OP	Geeft aan dat er een risico op ernstig letsel of structurele schade bestaat.

- Geef deze handleiding na lezing aan de eindgebruiker voor toekomstige referentie.
- Bewaar deze handleiding voor toekomstige referentie en raadpleeg hem indien nodig. Deze handleiding moet overhandigd worden aan degene die de afstandsbediening repareert of verplaatst. Geef de handleiding door aan toekomstige gebruikers.

Algemene voorzorgsmaatregelen

WAARSCHUWING

Installeer de unit niet op een plek waar grote hoeveelheden olie, stoom, organische oplosmiddelen of corrosieve gassen, zoals zwavelhoudend gas, voorkomen of waar vaak zure of alkalische oplossingen of sprays gebruikt worden. Deze stoffen kunnen de prestaties van de unit in gevaar brengen of ervoor zorgen dat bepaalde onderdelen van de unit corroderen, wat kan leiden tot elektrische schok, storingen, rookvorming of brand.

Om het risico op kortsluiting, lekstromen, elektrische schok, storingen, rookvorming of brand te verkleinen, de afstandsbediening niet afwassen met water of een andere vloeistof.

Om het risico op elektrische schok, storingen, rookvorming of brand te verkleinen, de schakelaars/toetsen of andere elektrische onderdelen nooit bedienen of aanraken met natte handen.

Wanneer u de unit desinfecteert met alcohol, zorg dan voor goede ventilatie van het vertrek. De dampen van alcohol rond de unit kunnen een brand of explosie doen ontstaan wanneer de unit wordt ingeschakeld.

Om het risico op letsel of elektrische schok te verkleinen, de werking van de afstandsbediening stoppen en de afstandsbediening afdekken voordat met een chemische stof rond de afstandsbediening wordt gespoten.

Om het risico op letsel of elektrische schok te verkleinen, de werking stoppen en de voeding uitschakelen alvorens de afstandsbediening te reinigen, te onderhouden of te inspecteren.

Stop de werking als u iets ongewoons opmerkt (bijv. een brandlucht), schakel the unit uit en vraag advies aan uw leverancier. Wanneer u het product toch blijft gebruiken, kan dat leiden tot een elektrische schok, storingen of brand.

Alle deksels op de juiste manier installeren om vocht en stof uit de afstandsbediening te houden. Het ophopen van stof en water kan leiden tot elektrische schok, rookvorming of brand.

LET OP

Om het risico op brand of explosie te verkleinen, geen brandbare materialen rond de afstandsbediening plaatsen en geen brandbare sprays gebruiken.

Om het risico op schade aan de afstandsbediening te verkleinen, geen insecticide of andere brandbare sprays rechtstreeks op de afstandsbediening spuiten.

Om het risico van milieuvcontaminatie te verkleinen, voor de correcte verwijdering van de afstandsbediening een erkende instantie raadplegen.

Om het risico op elektrische schok of storingen te verkleinen, het aanraakpaneel, de schakelaars en de toetsen niet met een puntig of scherp voorwerp aanraken.

Om het risico op letsel en elektrische schok te verkleinen, de scherpe randen van bepaalde onderdelen niet aanraken.

Om het risico op letsel te verkleinen, bij werkzaamheden aan de afstandsbediening persoonlijke beschermingsmiddelen dragen.

Om letsel door gebroken glas te voorkomen, geen overmatige kracht uitoefenen op de glazen onderdelen.

Voorzorgsmaatregelen voor het verplaatsen of repareren van de afstandsbediening

WAARSCHUWING

De afstandsbediening mag alleen worden gerepareerd of verplaatst door gekwalificeerd personeel. Haal de afstandsbediening niet uit elkaar en breng er geen wijzigingen in aan. Een gebrekkige installatie of reparatie kan letsel, elektrische schok of brand veroorzaken.

LET OP

Om het risico op kortsluiting, een elektrische schok, brand of storingen te beperken, de printplaat niet met gereedschap of met de handen aanraken en ervoor zorgen dat zich geen stof op de printplaat kan ophopen.

Aanvullende voorzorgsmaatregelen

Om schade aan de afstandsbediening te voorkomen, het juiste gereedschap gebruiken voor het installeren, inspecteren en repareren van de afstandsbediening.

Deze afstandsbediening is uitsluitend ontworpen voor gebruik met het gebouwenbeheersysteem van Mitsubishi Electric. Het gebruik van deze afstandsbediening met andere systemen of voor andere doeleinden kan storingen veroorzaken.

Dit toestel is niet bedoeld voor gebruik door personen (inclusief kinderen) met verminderde lichamelijke, sensorische of geestelijke vermogens of onvoldoende ervaring en kennis, tenzij zij door degene die voor hun veiligheid verantwoordelijk is worden gecontroleerd of zijn geïnstrueerd over het gebruik van het toestel. Kinderen moeten in het oog worden gehouden om te voorkomen dat ze met het toestel zouden spelen.

Om verkleuringen te voorkomen, geen benzeen, verdunningsmiddel of chemische doekjes gebruiken om de afstandsbediening schoon te maken. Om de afstandsbediening schoon te maken, deze afnemen met een zachte doek met water en een mild reinigingsmiddel, het reinigingsmiddel afnemen met een natte doek en daarna droogmaken met een droge doek.

Om schade aan de afstandsbediening te voorkomen, deze beschermen tegen statische elektriciteit.

Dit toestel is bedoeld voor gebruik door deskundige of geoefende gebruikers in winkels, in de lichte industrie of in landbouwbedrijven, dan wel voor commercieel gebruik door niet-geoefende gebruikers.

Als de voedingskabel beschadigd is, moet deze om gevaar te voorkomen worden vervangen door de producent, diens onderhoudsinstallateur of een gelijkwaardig gekwalificeerde monteur.

Onderdelen van de afstandsbediening

Interface van de afstandsbediening - Statusdisplay/Hoofddisplay

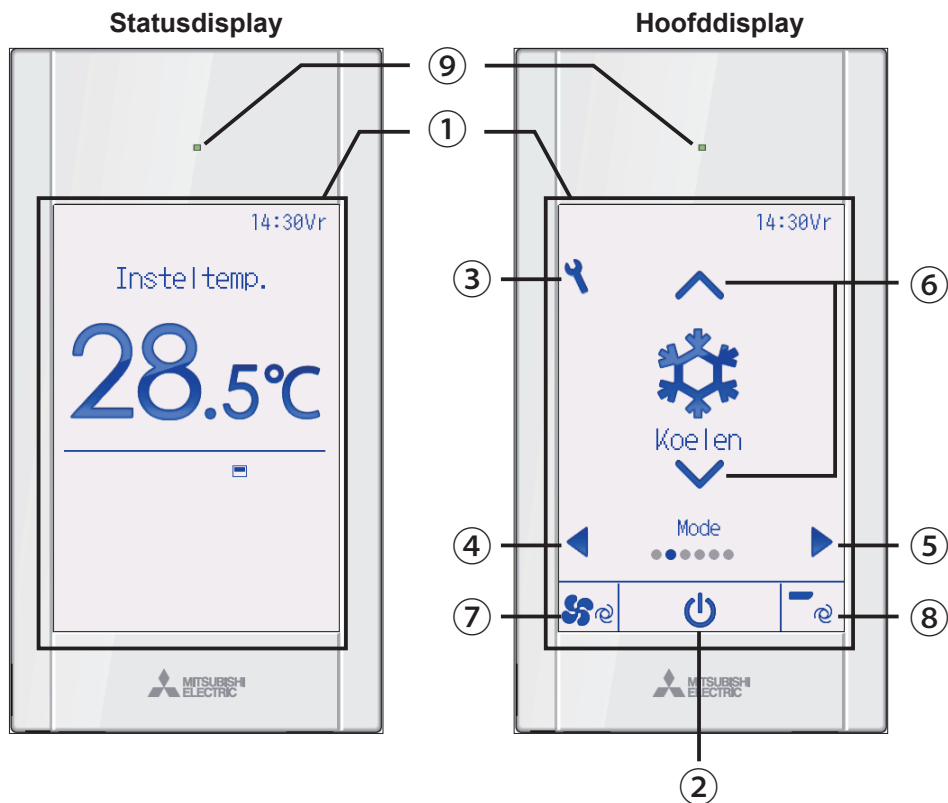

① Aanraakpaneel en kleuren-LCD met achtergrondverlichting

De bedieningsinstellingen zullen verschijnen. Wanneer de achtergrondverlichting uit is, gaat het scherm naar het Statusdisplay wanneer u ergens op het display drukt. Door ergens op het Statusdisplay te drukken gaat het scherm naar het Hoofddisplay.

② AAN/UIT toets

Drukken als u de binnenunit wilt in- of uitschakelen (AAN/UIT).

③ Instelling toets

Drukken als u het Hoofdmenu op het scherm wilt brengen. Wanneer de menubediening is vergrendeld, hebt u een beheerderswachtwoord nodig.

④ ◀ toets

Drukken om in de volgende volgorde naar de volgende instellingenitems te gaan: lamel, ventilatie, waaier, ventilatorsnelheid, bedieningsmodus en vooringestelde temperatuur.

⑤ ▶ toets

Drukken om in de volgende volgorde naar de volgende instellingenitems te gaan: vooringestelde temperatuur, bedieningsmodus, ventilatorsnelheid, waaier, ventilatie en lamel.

⑥ ▲ ▼ toets

Drukken om de inhoud van de in ④ and ⑤ hierboven geselecteerde instelling te wijzigen.

⑦ Sneltoets ventilatorsnelheid

Drukken om direct naar het instellingenschermb voor de ventilatorsnelheid te gaan.

⑧ Sneltoets waaier

Drukken om direct naar het instellingenschermb voor de waaier te gaan.

⑨ AAN/UIT-lampje

Dit lampje brandt groen zolang de unit werkt tenzij "LED-verlicht." op "Nee" wordt gezet. Het knippert wanneer de afstandsbediening opstart of wanneer er iets niet in orde is.

Wanneer de Aan/uit-bediening is vergrendeld, wordt ② niet weergegeven.

Wanneer het instellingsitem wordt ingeschakeld met de toets ④ of ⑤, wordt het item niet weergegeven als de werking van het geselecteerde item is vergrendeld.

Als de werking van de ventilatorsnelheid of de waaier is vergrendeld, wordt item ⑦ of ⑧ niet weergegeven.

De inhoud van de instellingen kan niet worden gewijzigd met toets ⑥ wanneer het instellingsitem centraal wordt geregeld door de systeemregeleenheid.

Onderdelen van de afstandsbediening

Interface van de afstandsbediening - menuscherm



① AAN/UIT toets

Drukken als u de binnenunit wilt in- of uitschakelen (AAN/UIT).

② SELECTEREN toets

Drukken als u de instelling wilt opslaan.

③ TERUG toets

Drukken als u naar het vorige scherm wilt terugkeren. Wanneer het Hoofdmenu wordt weergegeven, verschijnt het Statusdisplay door op deze toets te drukken.

④ MENU toets Pagina 24

Drukken als u het Hoofdmenu op het scherm wilt brengen.

⑤ Functietoets F1

Menuscherf: de toetsfunctie varieert met het scherm.

⑥ Functietoets F2

Hoofdmenu: drukken als u de cursor naar links wilt verplaatsen.

Menuscherf: de toetsfunctie varieert met het scherm.

⑦ Functietoets F3

Hoofdmenu: drukken als u de cursor naar rechts wilt verplaatsen.

Menuscherf: de toetsfunctie varieert met het scherm.

⑧ Functietoets F4

Menuscherf: de toetsfunctie varieert met het scherm.

De functie van de functietoetsen is afhankelijk van het scherm. In de gids voor de functie van toetsen die onderaan het LCD-scherf wordt weergegeven, ziet u welke functie de toetsen hebben in een bepaald scherm.

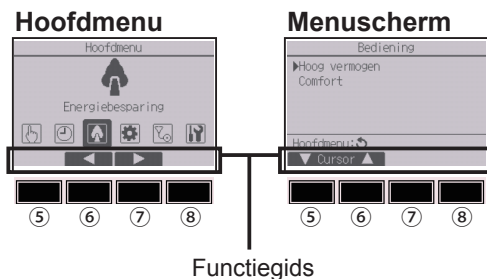

Onderdelen van de afstandsbediening

Display - Statusdisplay/Hoofddisplay

Het Statusdisplay en het Hoofddisplay kunnen in twee verschillende modi worden weergegeven: "Volledig" en "Basis".
De fabrieksinstelling is "Volledig". Zie pagina 58 om te zien hoe u kunt wisselen tussen de modi.

Modus Volledig

* Alle pictogrammen worden weergegeven ter verklaring.

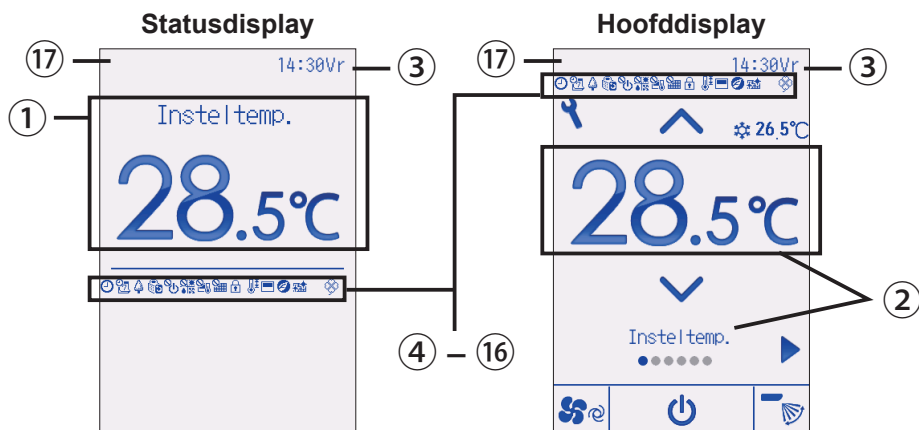

Modus Basis

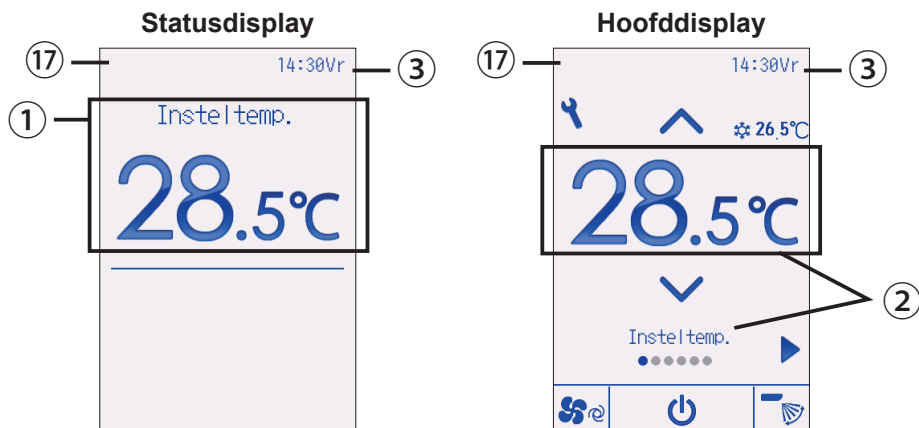

① Vooringestelde temperatuur of kamertemperatuur

Vooringestelde temperatuur of kamertemperatuur verschijnt hier. (Zie de Installatiehandleiding.)

② Instellingsitem en inhoud instellingen Pagina 17

De instellingsitems “Vooraf ingestelde temperatuur” ↔ “Bedieningsmodus” ↔ “Ventilatorsnelheid” ↔ “Waaier” ↔ “Ventilatie” ↔ “Lamel” en de inhoud an de instellingen verschijnen hier. “Centraal vergrendeld” verschijnt gedurende enige tijd wanneer een centraal geregeld item bediend wordt.

③ Klok

De actuele tijd verschijnt hier. (Zie de Installatiehandleiding.)

④ Pagina 29, 32, 40

Verschijnt wanneer de “Aan/uit-timer” (Pagina 29), “Nachtverlaging” (Pagina 40), of functie “Auto-uit-timer” (Pagina 32) is ingeschakeld.

 verschijnt wanneer de timer uitgeschakeld is door het gecentraliseerde regelsysteem.

⑤ Pagina 34

Verschijnt wanneer de Weekklok is ingeschakeld.

⑥ Pagina 51

Verschijnt wanneer de units werken in de energiezuinige stand. (Zal niet verschijnen op bepaalde modellen van binneneenheden)

⑦ Pagina 37

Verschijnt zolang de buitenunits werken in de stille stand.

⑧ Pagina 17

Verschijnt wanneer de units centraal in- en uitgeschakeld worden (AAN/UIT).

⑨ Pagina 17

Verschijnt wanneer de bedieningsmodus centraal wordt geregeld.

⑩ Pagina 17

Verschijnt wanneer de vooraf ingestelde temperatuur centraal wordt geregeld.

⑪ Pagina 46

Verschijnt wanneer de filter-resetfunctie centraal wordt geregeld.

⑫ Pagina 46

Verschijnt wanneer de toetsen zijn vergrendeld.

⑬ Pagina 43

Verschijnt wanneer het bereik van de vooraf ingestelde temperatuur wordt beperkt.

⑭ Pagina 43

Verschijnt wanneer de ingebouwde thermistor op de afstandsbediening is ingeschakeld voor het bewaken van de kamertemperatuur.

 verschijnt wanneer de thermistor op de binneneenheid wordt geactiveerd om de kamertemperatuur te bewaken.

⑮ Pagina 78

Verschijnt als een energiebesparende bewerking wordt uitgevoerd met behulp van een functie “3D i-See sensor”.

⑯ Pagina 78

Duidt aan wanneer er onderhoud aan het filter nodig is.

⑰ **Weergave voorafgaande fout**

Er verschijnt een foutcode tijdens de voorafgaande fout.

Menustructuur en pictogrammen

Menustructuur

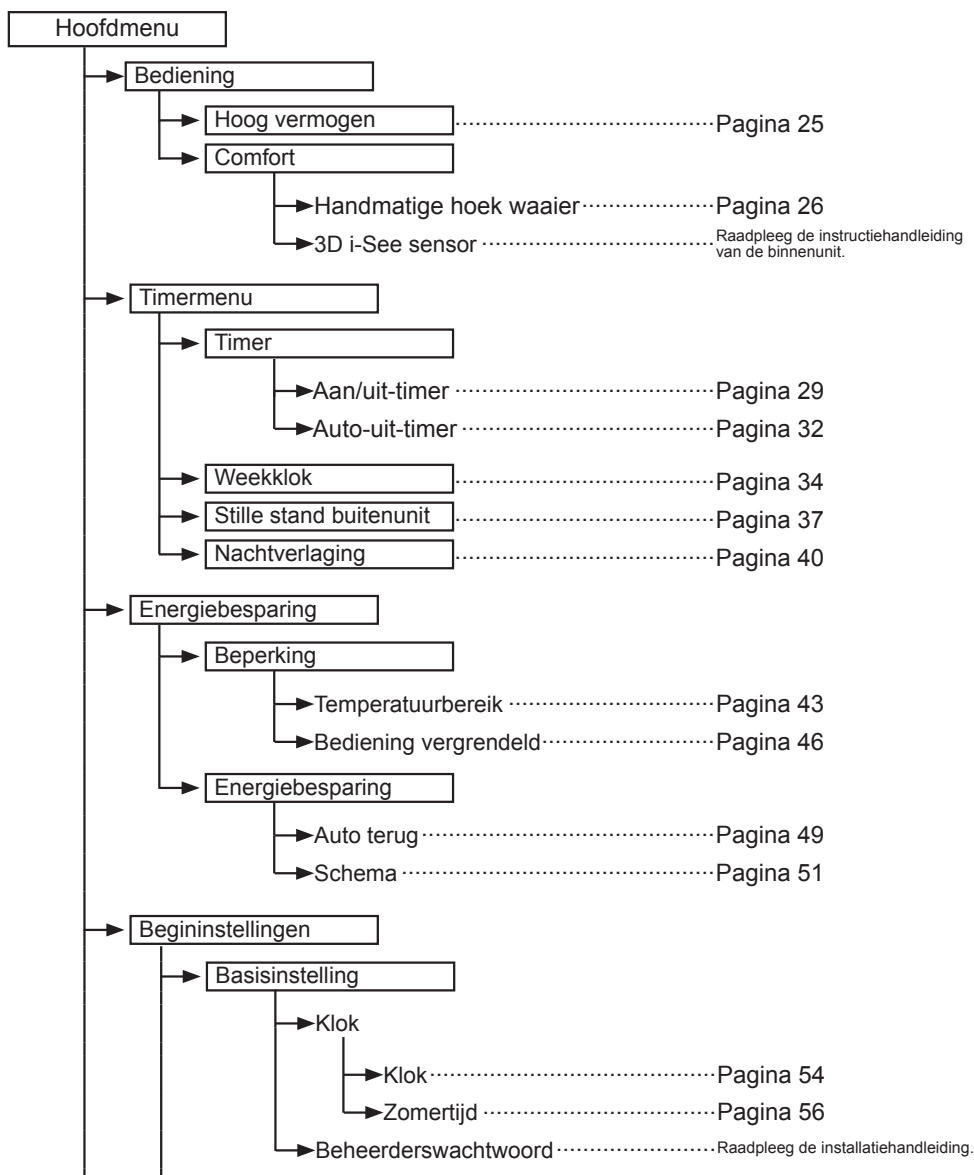

→	Display-instelling	
	→ Hoofddisplay	Pagina 58
	→ Details (Pictogramuitleg enz.)	Raadpleeg de installatiehandleiding.
	→ Helderheid	Pagina 61
	→ Taalkeuze	Pagina 62
	→ Ontwerp	Pagina 64
→	Bedieningsinstelling	
	→ Auto stand	Raadpleeg de installatiehandleiding.
→	Aanraakpaneel	Pagina 66
→	Onderhoudsmenu	
	→ Informatie over fout	Pagina 74
	→ Informatie over filter	Pagina 78
	→ Reiniging	
	→ Auto dalend rooster	Raadpleeg de instructiehandleiding die is geleverd bij het automatisch stijgende rooster.
	→ Laten dalen	Raadpleeg de instructiehandleiding die is geleverd bij het automatisch stijgende rooster.
	→ Aanpassen	Raadpleeg de instructiehandleiding die is geleverd bij het automatisch stijgende rooster.
→	Service	
	→ Menu Proefdraaien	
	→ Proefdraaien	Raadpleeg de installatiehandleiding van de binnenuit.
	→ Proefdraaien afvoerpomp	Raadpleeg de installatiehandleiding van de binnenuit.
	→ Onderhoudsinformatie	Raadpleeg de installatiehandleiding van de binnenuit.
	→ Modelnaam invoeren	Raadpleeg de installatiehandleiding van de binnenuit.
	→ Serienummer invoeren	Raadpleeg de installatiehandleiding van de binnenuit.
	→ Dealerinformatie invoeren	Raadpleeg de installatiehandleiding van de binnenuit.
	→ Onderhoudsinfo initialiseren	Raadpleeg de installatiehandleiding van de binnenuit.

Menustructuur en pictogrammen

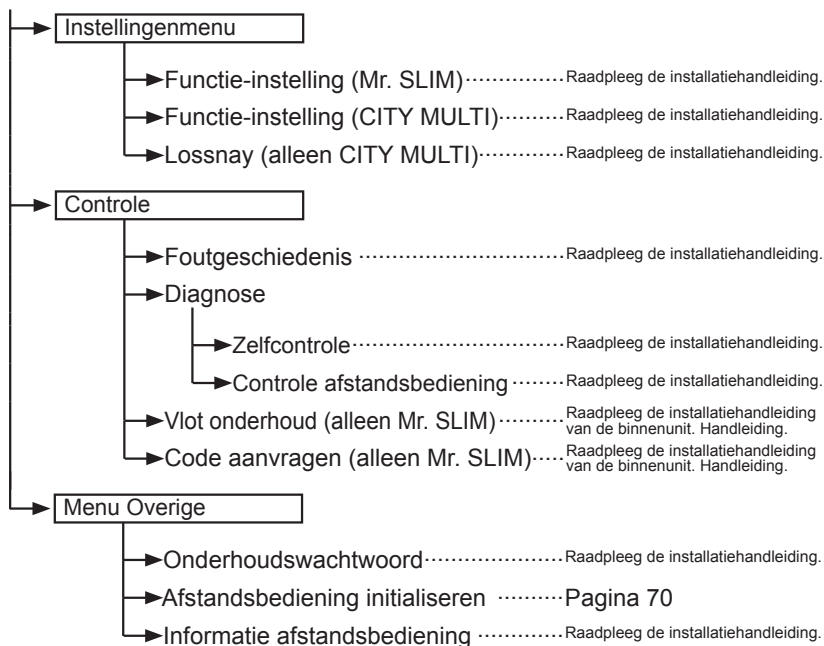

Niet alle functies zijn beschikbaar op alle modellen van de binnenunits.

Uitleg over pictogrammen

Bediening van controller

Timer



In de onderstaande tabel vindt u een overzicht van de vierkante pictogrammen die in deze handleiding worden gebruikt.



Er kunnen alleen instellingen worden gewijzigd als het beheerders- of onderhoudswachtwoord is ingevoerd in het wachtwoordinvoerscherm. Er zijn geen instellingen die buiten dit proces om kunnen worden ingevoerd.



F1 F2 F3 F4

- F1** : Drukken als u de cursor naar links wilt verplaatsen.
- F2** : Drukken als u de cursor naar rechts wilt verplaatsen.
- F3** : Drukken als u de waarde met 1 wilt doen afnemen.
- F4** : Drukken als u de waarde met 1 wilt doen toenemen.

* Er kunnen alleen veranderingen worden aangebracht als het juiste wachtwoord wordt ingevoerd.



Duidt instellingen aan die alleen kunnen worden gewijzigd als de units ingeschakeld zijn.



Duidt instellingen aan die alleen kunnen worden gewijzigd als de units niet ingeschakeld zijn.



Duidt instellingen aan die alleen kunnen gewijzigd als de Unix zijn ingeschakeld in de stand Koelen, Warmen of Auto.



Duidt functies aan die niet beschikbaar zijn wanneer de toetsen zijn vergrendeld of het systeem centraal wordt geregeld.

Basis bedieningshandelingen

AAN/UIT



Bediening van toetsen

AAN



Druk op de toets **AAN/UIT**.

Het AAN/UIT-lampje gaat groen branden en het systeem wordt ingeschakeld.

Wanneer “LED-verlicht.” op “Nee” wordt gezet, gaat het AAN/UIT-lampje niet branden.

AAN/UIT toets

UIT

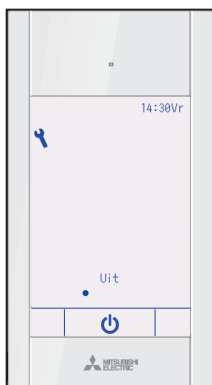

Druk nogmaals op de **AAN/UIT** toets.

Het AAN/UIT-lampje gaat uit en het systeem stopt.



Bediening van toetsen

Bedieningsmodus



Bij elke keer drukken op de toets ▼ of ▲ worden de volgende bedieningsmodi doorlopen.

Selecteer de bedieningsmodus van uw keuze.



Koelen



Drogen



Ventilator



Auto



Warmen

- Bedieningsmodi die niet beschikbaar zijn voor de modellen van de aangesloten binnenunits, verschijnen in het display.

Wat betekent het als het moduspictogram knippert

Het moduspictogram knippert wanneer andere binnenunits in het zelfde koelsysteem (aangesloten op dezelfde buitenunit) al werken in een andere stand. In dat geval kan de rest van de units in dezelfde groep alleen in dezelfde modus werken.

<Modus Auto (tweevoudig instelpunt)>

Als de werkingsmodus is ingesteld op de modus Auto (tweevoudig instelpunt), kunnen twee vooraf ingestelde temperaturen (één elk voor koeling en verwarming) worden ingesteld. Afhankelijk van de kamertemperatuur, zal de binnenunit automatisch werken in ofwel de modus “Koelen” of “Warmen” en de kamertemperatuur binnen het vooraf ingestelde bereik houden.

De onderstaande grafiek toont het werkingspatroon van binnenunit gebruikt in de modus “Auto” (tweevoudig instelpunt).

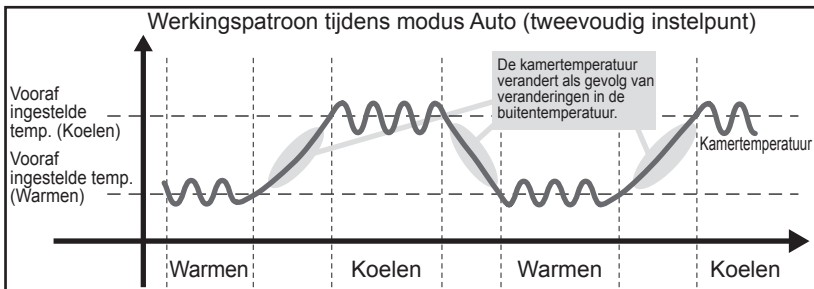

Basis bedieningshandelingen

Vooraf ingestelde temperatuur

<Koelen, Drogen, Warmen, en Auto (enkelvoudig instelpunt)>

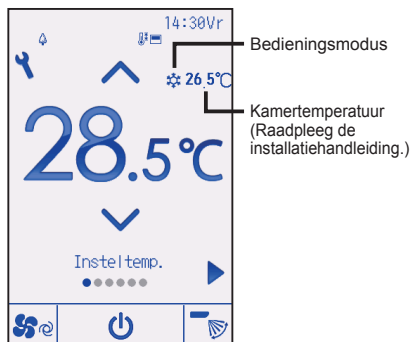

Druk op toets om de vooraf ingestelde temperatuur te verlagen en druk op toets als u deze wilt verhogen.

- In de tabel op pagina 19 vindt u het bereik van de instelbare temperatuur voor de verschillende bedieningsmodi.
- Het bereik van de vooraf ingestelde temperatuur kan niet worden ingesteld voor de bediening van Ventilator/Ventilatie.
- Vooraf ingestelde temperatuur wordt ofwel weergegeven in graden Celsius in stappen van 0,5 of 1 graad, of in Fahrenheit, afhankelijk van het model van de binnenunit en de weergavemodus op de afstandsbediening.

<Modus Auto (tweevoudig instelpunt)>

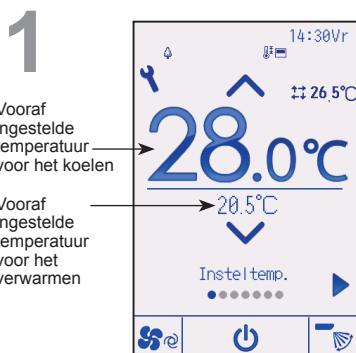

De huidige vooraf ingestelde temperaturen zullen verschijnen.

Bij elke keer drukken op de toets of wordt geschakeld tussen de vooraf ingestelde temperatuur voor koelen en verwarmen.

2

Vooraf ingestelde temperatuur voor het koelen

Vooraf ingestelde temperatuur voor het verwarmen

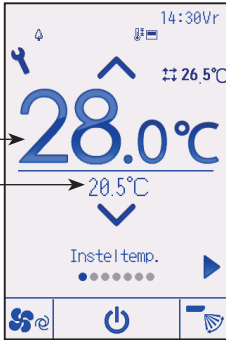

Druk op toets  om de geselecteerde temperatuur te verlagen en druk op toets  als u deze wilt verhogen.

- In de tabel hieronder vindt u het bereik van de instelbare temperatuur voor de verschillende bedieningsmodi.
- De vooraf ingestelde temperatuurinstellingen voor koelen en warmen in de modus Auto (tweevoudig instelpunt) worden ook gebruikt door de modi “Koelen”/“Drogen” en “Warmen”.
- De vooraf ingestelde temperaturen voor koelen en verwarmen in de modus Auto (tweevoudig instelpunt) moeten voldoen aan onderstaande condities:
 - Vooraf ingestelde koeltemperatuur is hoger dan vooraf ingestelde verwarmingstemperatuur.
 - Aan het minimale vereiste temperatuurverschil tussen de vooraf ingestelde temperaturen voor koeling en verwarming (afhankelijk van de modellen van de aangesloten binneneenheden) wordt voldaan.
 - Als vooraf ingestelde temperaturen ingesteld zijn op een manier dat niet voldaan wordt aan de vereiste voor minimum temperatuurverschil, zullen beide vooraf ingestelde temperaturen automatisch veranderd worden binnen het toegelaten bereik voor de instellingen.

Instelbaar bereik vooraf ingestelde temperatuur

Bedieningsmodus	Bereik vooraf ingestelde temperatuur
Koelen/Drogen	19 ~ 30°C (67 ~ 87°F)
Warmen	17 ~ 28°C (63 ~ 83°F)
Auto (Enkelvoudig instelpunt)	19 ~ 28°C (67 ~ 83°F)
Auto (Tweevoudige instelpunten)	[Koelen] Het bereik voor de vooraf ingestelde temperatuur voor de modus Koelen [Warmen] Het bereik voor de vooraf ingestelde temperatuur voor de modus Warmen
Ventilator/Ventilatie	Niet instelbaar

Het bereik vooraf ingestelde temperatuur varieert afhankelijk van het model van de binneneenheden.

Basis bedieningshandelingen

Ventilatorsnelheid



Bij elke keer drukken op de toets ▼ of ▲ worden de volgende ventilatorsnelheden doorlopen.



- Welke ventilatorsnelheden beschikbaar zijn is afhankelijk van het model van de aangesloten binneneenheden.

Waaierinstelling



(Voorbeeldscherm in CITY MULTI)

Bij elke keer drukken op de toets ▼ of ▲ worden de volgende waaierinstellingen doorlopen. Selecteer de instelling van uw keuze.

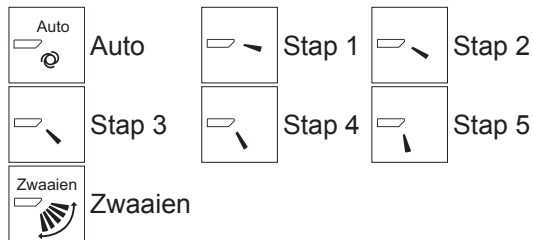

Selecteer “Zwaaien” als u wilt dat de waaiers automatisch op en neer bewegen.

Wanneer u “Stap 1” tot en met “Stap 5” instelt, wordt de waaier vast ingesteld in de geselecteerde hoek.

- **1h** links van het pictogram waaierinstelling
Dit pictogram verschijnt wanneer de waaier wordt ingesteld op “Stap 2, 3, 4 of 5” en de ventilator werkt op lage snelheid tijdens het koelen of drogen (dit hangt af van het model). Het pictogram verdwijnt na een uur en de instelling van de waaier verandert automatisch.

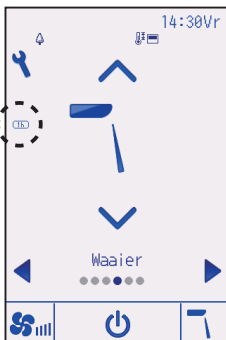

Lamelinstelling



(Voorbeeldscherm in CITY MULTI)

Druk op de toets ▼ of ▲ om de zwaaibeweging van de lamel in of uit te schakelen.



Uit



Aan

Ventilatie-instelling

De ventilatie kan ook worden ingesteld wanneer de units in werking zijn.



(Voorbeeldscherm in Mr. SLIM)

Bij elke keer drukken op de toets ▼ of ▲ worden de volgende ventilatie-instellingen doorlopen.

* Kan alleen worden ingesteld wanneer de Lossnay-unit is aangesloten.



Uit



Laag



Hoog

• De ventilator op sommige modellen binneneenheden kan zijn gekoppeld met bepaalde modellen ventilatie-eenheden.

Navigeren door het menu

Hoofdmenulijst

Hoofdmenu	Instellingsitems		Gegevens van instellingen	Pagina
Werking	Hoog vermogen		Hiermee bereikt u snel een comfortabele kamertemperatuur. • Units kunnen gedurende maximaal 30 minuten werken in de stand Hoog vermogen.	25
	Comfort	Handmatige hoek waaier	Hiermee stelt u elke hoek van de waaier vast.	26
Timer	Timer	Aan/uit-timer	Hiermee stelt u de tijden in voor in- en uitschakelen (On/Off). • U kunt de tijd instellen in stappen van 5 minuten. * De klok moet zijn ingesteld.	29
		Auto-uit-timer	Hiermee stelt u de Auto-Off-tijd in. • U kunt de tijd instellen op een waarde van 30 tot 240 minuten in stappen van 10 minuten.	32
	Weekklok		Hiermee stelt u de tijden voor in- en uitschakelen per week in (On/Off). • Per dag kunnen maximaal acht patronen voor de bediening worden ingesteld. • Er kunnen twee typen wekschema's worden ingesteld. * De klok moet zijn ingesteld. * Geldt niet wanneer de Aan/uit-timer is ingeschakeld. * (Stappen van 1°C)	34
	Stille stand buitenunit		Hiermee kunt u de perioden instellen waarin de stille werking van buitenunits voorrang heeft boven temperatuurregeling. U kunt de Start/Stop-tijden voor elke dag van de week instellen. • Maak een keuze voor het niveau van de stille stand uit "Normaal," "Midden" en "Rustig." * De klok moet zijn ingesteld.	37
	Nachtverlaging		Hiermee voert u instellingen voor Nachtverlaging uit • Selecteer "Ja" als u de instelling wilt inschakelen en "Nee" als u de instelling wilt uitschakelen. Het temperatuurbereik en de start/stop-tijden kunnen worden ingesteld. * De klok moet zijn ingesteld. * (Stappen van 1°C)	40
Energiebesparing	Beperking	Temperatuurbereik	Hiermee kunt u het bereik van de vooraf ingestelde temperatuur beperken. • Er kunnen verschillende temperatuurbereiken worden ingesteld voor verschillende bedieningsmodi. * (Stappen van 1°C)	43
		Bediening vergrendeld	Hiermee kunt u geselecteerde functies vergrendelen. • De geblokkeerde functies kunnen niet worden bediend.	46
	Energiebesparing	Auto terug	Hiermee kunt u de units op de vooraf ingestelde temperatuur laten werken nadat zij gedurende een bepaalde tijd in de energiezuinige stand hebben gewerkt. • U kunt de tijd instellen op een waarde van 30 tot 120 minuten in stappen van 10 minuten. * Deze functie is niet bruikbaar wanneer de bereiken van de vooraf ingestelde temperatuur beperkt zijn. * (Stappen van 1°C)	49

Hoofdmenu	Instellingsitems		Gegevens van instellingen	Pagina
Energiebesparing	Energiebesparing	Schema	<p>Hiermee kunt u voor elke dag van de week de Start/Stop-tijden instellen voor de bediening van de units in de energiezuinige stand en kunt u de mate van energiebesparing instellen.</p> <ul style="list-style-type: none"> • U kunt per dag maximaal vier bedieningspatronen voor energiebesparing instellen. • U kunt de tijd instellen in stappen van 5 minuten. • De mate van energiebesparing kunt u instellen op een waarde van 0% en 50 tot 90% in stappen van 10%. <p>* De klok moet zijn ingesteld.</p>	51
Initiële instelling	Basisinstelling	Klok	Hiermee stelt u de actuele tijd in.	54
		Zomertijd	Stelt de zomertijd in.	56
	Display-instelling	Hoofddisplay	Hiermee schakelt u over tussen de modi “Volledig” en “Basis” voor het Statusdisplay en het Hoofddisplay.	58
		Helderheid	Hiermee kunt u de schermhelderheid aanpassen.	61
		Taalkeuze	Hiermee kunt u de taal van uw keuze selecteren.	62
		Ontwerp	Hiermee verandert u de kleur van het Statusdisplay en het Hoofddisplay.	64
	Aanraakpaneel	Aanraakpaneel kalibratie	Stelt de kalibratie-instellingen voor het aanraakpaneel in.	66
Aanraakpaneel reinigen		Maakt het aanraakpaneel tijdelijk ongevoelig voor aanraking zodat het kan worden schoongemaakt.	68	
Service	Afstandsbediening initialiseren	Hiermee initialiseert u de afstandsbediening naar de fabriekstoestand bij verzending.	70	
	Informatie afstandsbediening	Hiermee geeft u de modelnaam, softwareversie en het serienummer van de afstandsbediening weer.	72	
Onderhoud	Informatie over fout	<p>Hiermee kunt u de Informatie over fout controleren wanneer er zich fout voordoet.</p> <ul style="list-style-type: none"> • Foutcode, oorsprong van de fout, koeladres, model van de unit, fabricagenummer, contactinformatie (telefoonnummer van de dealer) kunnen worden weergegeven. <p>* Het model van de unit, fabricagenummer en de contactinformatie kunnen alleen worden weergegeven als zij van tevoren zijn geregistreerd.</p>	74	
	Informatie over filter	<p>Hiermee kunt u de filterstatus controleren</p> <ul style="list-style-type: none"> • De filtermarkering kan worden gereset. 	78	

Navigeren door het menu

Navigeren door het Hoofdmenu

Bediening van toetsen

Naar het Hoofdmenu gaan



Druk op de toets **[Instelling]** op het Hoofddisplay.

Het Hoofdmenu verschijnt.

Itemselectie



Druk op **[F2]** als u de cursor naar links wilt verplaatsen.

Druk op **[F3]** als u de cursor naar rechts wilt verplaatsen.

Functie-instellingen

Hoog vermogen



Omschrijving van de functies

Met de functie Hoog vermogen kunnen de units werken op een capaciteit die hoger is dan normaal zodat het vertrek snel optimaal op temperatuur kan worden gebracht. Deze functie werkt maximaal 30 minuten en de unit keert terug naar de normale bedieningsmodus na deze 30 minuten of wanneer de kamertemperatuur de vooraf ingestelde temperatuur bereikt, welke hiervan zich het eerst voordoet. De units keren terug naar de normale werking wanneer de bedieningsmodus of de ventilatorsnelheid wordt gewijzigd.

Bediening van toetsen

1



Selecteer “Hoog vermogen” in het bedieningsmenu tijdens Koelen, Warmen of Auto en druk op de toets **SELECTEREN**.

De functie “Hoog vermogen” is alleen beschikbaar op de modellen die de functie ondersteunen.

2



Verplaats de cursor met toets **F3** of **F4** naar “Ja” en druk op de toets **SELECTEREN**.

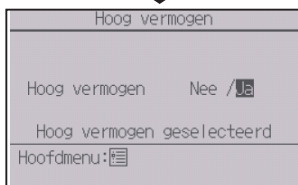

Er verschijnt een bevestigingsscherm.

Navigeren door de schermen

- Terug naar het Hoofdmenu **MENU** toets
- Om terug te gaan naar het vorige scherm **TERUG** toets

Functie-instellingen

Handmatige hoek waaier

OFF

Bediening van toetsen

1



Selecteer “Comfort” in het bedieningsmenu en druk op de toets **SELECTEREN**.

2



Selecteer met toets **F1** of **F2** “Handmatige hoek waaier” een druk op de toets **SELECTEREN**.

3



Verplaats de cursor naar "Koeladres" of "Unitnummer" en selecteer met toets **F1**.
Selecteer met toets **F2** of **F3** het koeladres unitnummer voor de units waarvan u de waaiers vast wilt zetten en druk op de toets **SELECTEREN**.

- Koeladres: Koeladres
- Unitnummer: 1, 2, 3, 4

Druk op toets **F4** als u de selectie van de unit wilt bevestigen.

Het scherm links toont een voorbeeld-display van units Mr. SLIM. Op CITY MULTI wordt "M-NET-adres" getoond in plaats van "Koeladres" en het "Unitnummer" wordt niet getoond.

4



Selecteer "Waaier" met toets **F1**.

Selecteer "4-weg" of "2-weg" met toets **F2** of **F3** en druk op toets **F4**.

Functie-instellingen

5

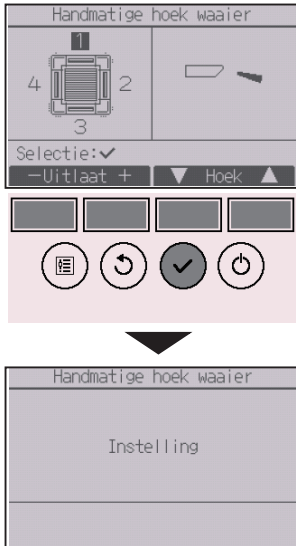

De actuele waaierinstelling verschijnt.

Selecteer de gewenste uitgangen van “1”, “2”, “3”, “4” of “1, 2, 3, 4 (alle uitgangen)” met toets **[F1]** of **[F2]**.

Druk op de toets **[F3]** of **[F4]** om de volgende opties te doorlopen en selecteer de instelling van uw keuze.

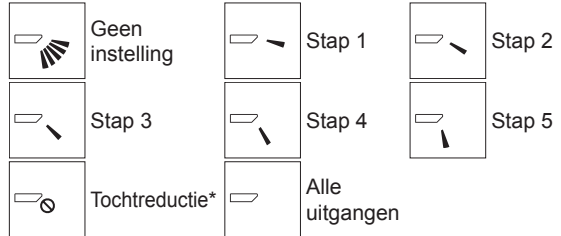

Druk op de toets **[SELECTEREN]** als u de instellingen wilt opslaan.

Er verschijnt een scherm waarop wordt aangeduid dat de instel informatie wordt verzonden.

De wijzigingen in de instellingen worden uitgevoerd op de geselecteerde uitgang.

Het scherm keert automatisch terug naar het vorige scherm wanneer de transmissie is voltooid.

Voerde instellingen uit voor andere uitgangen en volgt daarbij dezelfde procedure.

Als alle uitgangen zijn geselecteerd, wordt  getoond de volgende keer dat de unit in werking wordt gesteld.

Navigeren door de schermen

• Terug naar het vorige scherm **[TERUG]** toets

*Tochtreductie

De modus [Tochtreductie] houdt de schoephoek horizontaler dan de hoek van Positie 1 zodat de luchtstroom niet op de mensen wordt gericht.

Deze functie kan slechts voor één uitgang worden ingesteld.

Deze functie kan niet worden ingesteld voor modellen met twee of drie uitgangen. In de modus Tochtreductie kan de luchtstroom verkleuring aan het plafond veroorzaken.

Bediening van toetsen

1

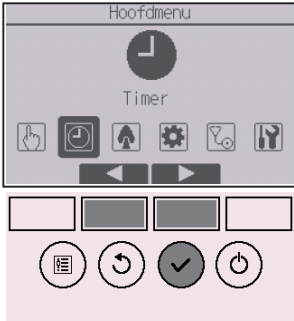

Selecteer "Timer" in het Hoofdmenu (raadpleeg pagina 24) en druk op de toets **SELECTEREN**.

De Aan/uit-timer zal in de volgende gevallen niet werken:

wanneer de Aan/uit-timer is uitgeschakeld, bij een fout, bij controle (in het servicemenu, tijdens proefdraaien, tijdens diagnose van de afstandsbediening, wanneer de klok niet is ingesteld, tijdens het instellen van functies, wanneer het systeem centraal wordt geregeld (wanneer "Aan/uit"-bediening of timerbediening vanaf lokale afstandsbediening niet wordt toegelaten).

2



Verplaats de cursor naar "Timer" en druk op de toets **SELECTEREN**.

3



De actuele instellingen verschijnen.

Verplaats de cursor naar "Aan/uit-timer" en druk op de toets **SELECTEREN**.

Funcie-instellingen

4



Het scherm voor het instellen van de timer verschijnt.

Maak met toets **F1** of **F2** een keuze uit “Aan/uit-timer”, “Aan”, “Uit” of “Herhalen”.

5



Wijzig de instelling met toets **F3** of **F4**.

- Aan/uit-timer: Nee (uitschakelen)/Ja (inschakelen)
- Aan: Starttijd werking
(instelbaar in stappen van 5 minuten)
* Houd de toets ingedrukt als u de nummers snel vooruit wilt laten lopen.
- Uit: Stoptijd werking
(instelbaar in stappen van 5 minuten)
* Houd de toets ingedrukt als u de nummers snel vooruit wilt laten lopen.
- Herhalen: Nee (éénmaal)/Ja (herhalen)

6



Druk op de toets **SELECTEREN** als u de instellingen wilt opslaan.





Er verschijnt een bevestigingsscherm.

Navigeren door de schermen

- Terug naar het Hoofdmenu **MENU** toets
- Om terug te gaan naar het vorige scherm **TERUG** toets



 verschijnt op het Statusdisplay en het Hoofddisplay in de modus Volledig wanneer de Aan/uit-timer is ingeschakeld.

 verschijnt wanneer de timer uitgeschakeld is door het gecentraliseerde regelsysteem.

Functie-instellingen

Timer (Auto-uit-timer)



Bediening van toetsen

1



Ga naar het Timer-instellingenschermb.
(Raadpleeg pagina 29.)

Selecteer "Auto-uit" en druk op de toets

SELECTEREN.

De Auto-uit-timer zal in de volgende gevallen niet werken:

wanneer de Auto-uit-timer is uitgeschakeld, bij een fout, bij controle (in het servicemenu), tijdens proefdraaien, tijdens diagnose van de afstandsbediening, tijdens het instellen van functies, wanneer het systeem centraal wordt geregeld (wanneer "Aan/uit"-bediening of timerbediening vanaf lokale afstandsbediening niet wordt toegelaten).

2



De actuele instellingen verschijnen.

Verplaats de cursor naar "Auto-uit" of "Stoppen na --- min." met de toets **F1** of **F2**.

3



Wijzig de instelling met toets **F3** of **F4**.

- Auto-uit: Nee (uitschakelen)/Ja (inschakelen)
- Stoppen na --- min.: timerinstelling (Het in te stellen bereik is 30 tot 240 minuten in stappen van 10 minuten.)

4



Druk op de toets **SELECTEREN** als u de instellingen wilt opslaan.





Er verschijnt een bevestigingsscherm.

Navigeren door de schermen

- Terug naar het Hoofdmenu **MENU** toets
- Om terug te gaan naar het vorige scherm **TERUG** toets



 verschijnt op het Statusdisplay en het Hoofddisplay in de modus Volledig wanneer de Auto-uit-timer is ingeschakeld.

 verschijnt wanneer de timer uitgeschakeld is door het gecentraliseerde regelsysteem.

Functie-instellingen

Weekklok



Bediening van toetsen

1



Selecteer “Weekklok” in het Timermenu en druk op de toets **SELECTEREN**.

De Weekklok zal in de volgende gevallen niet werken:

wanneer de Aan/uit-timer is ingeschakeld, wanneer de Weekklok is uitgeschakeld, bij een fout, bij controle (in het servicemenu), tijdens proefdraaien, tijdens diagnose van de afstandsbediening, wanneer de klok niet is ingesteld, tijdens het instellen van functies, wanneer het systeem centraal wordt geregeld (wanneer “Aan/uit”-bediening, temperatuurinstelling of timerbediening vanaf lokale afstandsbediening niet wordt toegelaten).

2



De actuele instellingen verschijnen.

Wanneer u op toets **F1** of **F2** drukt, kunt u de instellingen voor elke dag van de week zien.

Druk op toets **F3** als u de patronen 5 tot en met 8 wilt zien.

Druk op de toets **F4** om de status van instelling 2 weer te geven.

Druk op de toets **SELECTEREN** als u naar het instelscherm wilt gaan.

3



Het instelscherm voor de weekklok verschijnt.

In de instelling “Actie” selecteert u “1” om timerinstelling 1 in te schakelen of selecteert u “2” om timerinstelling 2 in te schakelen met de toets **F3** of **F4**. Druk vervolgens op de toets **SELECTEREN**.

Om de inhoud van de timerinstelling 1 of 2 te controleren, verplaatst u de cursor met de toets **F1** of **F2** naar “Instelling” en selecteert u “1” of “2” met de toets **F3** of **F4**.

4



Het instelscherm van de Weekklok verschijnt en de actuele instellingen worden getoond.

Per dag kunnen maximaal acht patronen voor de bediening worden ingesteld.

Verplaats met toets **F1** of **F2** de cursor naar de dag van de week en selecteer deze door op toets **F3** te drukken. (U kunt meerdere dagen selecteren.)

Druk op de toets **SELECTEREN**.

Functie-instellingen

5

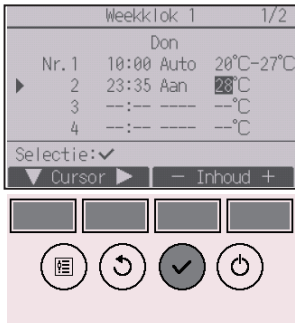

Het instelscherm voor het bedieningspatroon verschijnt. Verplaats de cursor met toets **[F1]** naar het nummer van het patroon van uw keuze.

Verplaats de cursor met toets **[F2]** naar de tijd, Aan/Uit of de temperatuur.

Wijzig de instellingen met toets **[F3]** of **[F4]**.

- Tijd: in te stellen in stappen van 5 minuten
* Houd de toets ingedrukt als u de nummers snel vooruit wilt laten lopen.
- Aan/Uit/Auto: Selecteerbare instellingen zijn afhankelijk van het model van de aangesloten binnenunit. (Wanneer een Auto-patroon wordt uitgevoerd, zal het systeem in de modus Auto (tweevoudig instelpunt) werken.)
- Temperatuur: Het instelbare temperatuurbereik is afhankelijk de aangesloten binnenunits. (Stappen van 1°C) Wanneer de modus Auto (tweevoudig instelpunt) is geselecteerd, kunnen twee vooraf ingestelde temperaturen worden ingesteld. Als een werkingspatroon met een enkele vooraf ingestelde temperatuur wordt uitgevoerd tijdens de modus Auto (tweevoudig instelpunt) wordt de instelling daarvan gebruikt als de koeltemperatuur in de modus "Koelen".

Druk op de toets **[SELECTEREN]** als u de instellingen wilt opslaan.

Er verschijnt een bevestigingsscherm.

Navigeren door de schermen

- Terug naar het selectiescherm wijziging instelling/dag van de week **[SELECTEREN]** toets
- Terug naar het Hoofdmenu **[MENU]** toets
- Terug naar het vorige scherm **[TERUG]** toets



[?] verschijnt op het Statusdisplay en het Hoofddisplay in de stand Volledig wanneer de instelling van Weekklok voor de actuele dag bestaat. Het pictogram verschijnt niet wanneer de Aan/uit-timer is ingeschakeld of het systeem onder gecentraliseerde regeling is (instelling van de timerfunctie vanaf lokale afstandsbediening is niet toegestaan).

Omschrijving van de functies

Met deze functie kan de gebruiker de perioden instellen waarin de stille werking van buitenunits voorrang heeft boven temperatuurregeling. Stel iedere dag van de week de start- en stoptijden in voor de stille werking. Maak een keuze voor het niveau van de stille stand uit "Midden" en "Rustig".

Bediening van toetsen

1



Selecteer "OU stille stand" in het Timermenu en druk op de toets **SELECTEREN**.

De functie "OU stille stand" is alleen beschikbaar op de modellen die de functie ondersteunen.

2



De actuele instellingen verschijnen.

Wanneer u op toets **F1** of **F2** drukt, kunt u de instellingen voor elke dag van de week zien. Druk op de toets **SELECTEREN** als u naar het instelscherm wilt gaan.

Funcctie-instellingen

3



U kunt de stille stand inschakelen (Ja) en uitschakelen (Nee) in het scherm dat verschijnt.

Verplaats de cursor naar "Ja" met toets **F3** of **F4** en druk op de toets **SELECTEREN** als u de instelling wilt inschakelen.

4



Het instelscherm voor de Stille stand buitenunit verschijnt.

Als u de instelling wilt invoeren of wijzigen, verplaatst u met toets **F1** of **F2** de cursor naar de dag van de week en selecteert u deze door op toets **F3** te drukken. (U kunt meerdere dagen selecteren.)

Druk op de toets **SELECTEREN**.

5

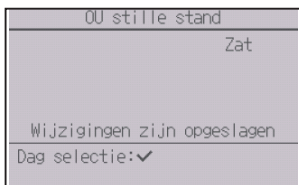

Het instelscherm verschijnt.

Verplaats de cursor met toets **[F1]** of **[F2]** naar Starttijd, Stoptijd of niveau Stille stand.

Wijzig de instellingen met toets **[F3]** of **[F4]**.

- Start-/Stoptijd: in te stellen in stappen van 5 minuten
- * Houd de toets ingedrukt als u de nummers snel vooruit wilt laten lopen.
- Stille stand: Normaal, Midden, Rustig



Normaal



Midden



Rustig

Druk op de toets **[SELECTEREN]** als u de instellingen wilt opslaan. Er verschijnt een bevestigingsscherm.

Navigeren door de schermen

- Terug naar het selectiescherm wijziging instelling/dag van de week..... **[SELECTEREN]** toets
- Terug naar het Hoofdmenu **[MENU]** toets
- Terug naar het vorige scherm **[TERUG]** toets



 verschijnt op het Statusdisplay en het Hoofddisplay in de modus Volledig tijdens de Stille stand buitenunit.

Functie-instellingen

Nachtverlaging



Omschrijving van de functies

Deze regelfunctie start de verwarming wanneer de regelobjectgroep gestopt is en de kamertemperatuur daalt onder de ondergrens van de vooraf ingestelde temperatuur. Ook start deze regelfunctie het koelen wanneer de regelobjectgroep gestopt is en de kamertemperatuur stijgt boven de bovengrens van de vooraf ingestelde temperatuur.

De functie Nachtverlaging is niet beschikbaar als de bediening en de instelling van de temperatuur worden geregeld met de afstandsbediening.

Als de kamertemperatuur wordt gemeten door de aanzuigtemperatuursensor van de airconditioner, zal misschien niet een nauwkeurige meting van de temperatuur worden verkregen wanneer de airconditioner niet actief is of wanneer de lucht niet schoon is. Schakel in dat geval de sensor over op een sensor op afstand (PAC-SE40TSA/PAC-SE41TS-E) of op een regelsensor op afstand.

Bediening van toetsen

1



Selecteer “Nachtverlaging” in het Timermenu en druk op de toets **SELECTEREN**.

2



De actuele instellingen verschijnen.

Druk op de toets **SELECTEREN** als u naar het instelscherm wilt gaan.

3

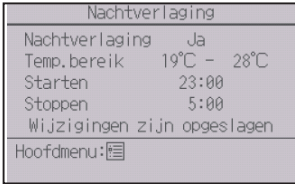

Verplaats de cursor met toets **[F1]** of **[F2]** naar Nachtverlaging Nee (uitschakelen)/Ja (inschakelen), Temperatuurbereik, Starttijd of Stoptijd.

Wijzig de instellingen met toets **[F3]** of **[F4]**.

- Temp.bereik: u kunt de ondergrens voor de temperatuur (voor verwarming) en de bovengrens voor de temperatuur (voor koeling) instellen. Het temperatuurverschil tussen de onder- en bovengrens moet 4°C (8°F) of meer zijn. Het instelbare temperatuurbereik is afhankelijk de aangesloten binnenuits.
* (Stappen van 1°C)
- Start-/Stoptijd: in te stellen in stappen van 5 minuten
* Houd de toets ingedrukt als u de nummers snel vooruit wilt laten lopen.

Druk op de toets **[SELECTEREN]** als u de instellingen wilt opslaan.

Er verschijnt een bevestigingsscherm.

Navigeren door de schermen

- Terug naar het Hoofdmenu **[MENU]** toets
- Terug naar het vorige scherm **[TERUG]** toets

Functie-instellingen



 verschijnt op het Statusdisplay en het Hoofddisplay in de modus Volledig wanneer de functie Nachtverlaging is ingeschakeld.

 verschijnt wanneer de timer uitgeschakeld is door het gecentraliseerde regelsysteem.

De Nachtverlaging zal in de volgende gevallen niet werken:

wanneer de unit in werking is, wanneer de functie Nachtverlaging is uitgeschakeld, bij een fout, bij controle (in het servicemenu), tijdens proefdraaien, tijdens diagnose van de afstandsbediening, wanneer de klok niet is ingesteld, tijdens het instellen van functies, wanneer het systeem centraal wordt geregeld (wanneer "Aan/uit"-bediening, temperatuurstelling of timerbediening vanaf lokale afstandsbediening niet wordt toegelaten).

De beperking van het temperatuurbereik instellen

Bediening van toetsen

1



Selecteer "Energiebesparing" in het Hoofdmenu (raadpleeg pagina 24) en druk op de toets **SELECTEREN**.

2

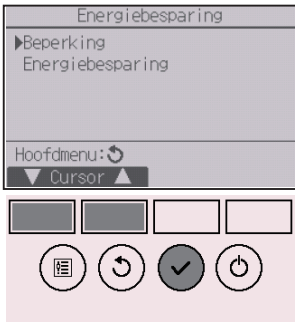

Verplaats de cursor met toets **F1** of **F2** naar "Beperking" en druk op de toets **SELECTEREN**.

Functie-instellingen

3



De actuele instellingen verschijnen.

Verplaats de cursor met toets **F1** of **F2** naar “Temp. bereik” en druk op de toets **SELECTEREN**.

4



Het scherm voor het instellen van het temperatuurbereik verschijnt.

Verplaats de cursor met de toets **F1** naar “Temp. bereik”, “Koel-Drogen”, “Warmen” of “Auto.”

5

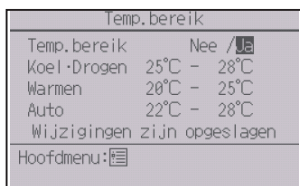
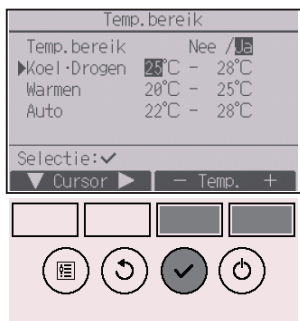

Wijzig de instellingen met toets **[F3]** of **[F4]**.

- Temp.bereik: Nee (onbeperkt) of Ja (beperkt)
- Koel•Drogen: Boven- en ondergrens temperatuur (stappen van 1°C)
- Warmen: Boven- en ondergrens temperatuur (stappen van 1°C)
- Auto: Boven- en ondergrens temperatuur (stappen van 1°C)

Instelling temperatuurbereik

Stand	Ondergrens	Bovengrens
Koel•Drogen *1 *3	19 ~ 30°C (67 ~ 87°F)	30 ~ 19°C (87 ~ 67°F)
Warmen *2 *3	17 ~ 28°C (63 ~ 83°F)	28 ~ 17°C (83 ~ 63°F)
Auto *4	19 ~ 28°C (67 ~ 83°F)	28 ~ 19°C (83 ~ 67°F)

* Het instelbare bereik is afhankelijk de aangesloten unit.

*1 Temperatuurbereiken voor de modi "Koelen", "Drogen" en "Auto" (tweevoudig instelpunt) kunnen worden ingesteld.

*2 Temperatuurbereiken voor de modi "Warmen" en "Auto" (tweevoudig instelpunt) kunnen worden ingesteld.

*3 Temperatuurbereiken voor de modi "Warmen", "Koelen" en "Drogen" moeten voldoen aan de onderstaande condities:

- Bovenste limiet voor koelen - bovenste limiet voor warmen \geq minimum temperatuurverschil (varieert per model binneneenheid)
- Onderste limiet voor koelen - onderste limiet voor warmen \geq minimum temperatuurverschil (varieert per model binneneenheid)

*4 Temperatuurbereik voor de modus "Auto" (enkelvoudig instelpunt) kan worden ingesteld.

Druk op de toets **[SELECTEREN]** als u de instellingen wilt opslaan.

Er verschijnt een bevestigingsscherm.

Navigeren door de schermen

- Terug naar het Hoofdmenu **[MENU]** toets
- Terug naar het vorige scherm **[TERUG]** toets



 verschijnt op het Statusdisplay en het Hoofddisplay in de modus Volledig wanneer het temperatuurbereik beperkt is.

Functie-instellingen

Beperking



Functie bedieningsvergrendeling

U schakelt de functie voor bedieningsvergrendeling in door het item "Bedien. vergrend." op "Ja" in te stellen.

Bediening van toetsen

1



Ga naar het instelscherm Beperking. (Raadpleeg pagina 43.)

Verplaats de cursor naar "Bedien. vergrend." en druk op de toets **SELECTEREN**.

2

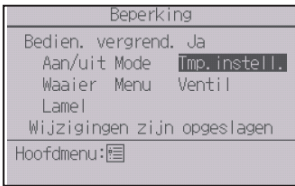

Het scherm voor het uitvoeren van de instellingen voor de functie bedieningsvergrendeling verschijnt.

Verplaats de cursor met toets **F1** of **F2** naar “Bedien. vergrend.”, “Locatie”, “Aan/uit”, “Mode”, “Tmp.instell.”, “Menu”, “Ventil”, “Lamel” of “Waaier”.

Wijzig de instellingen met toets **F3** of **F4**.

- Bedien. vergrend.: Nee (uitschakelen)/Ja (inschakelen)
- Locatie: “Indiv.” of “Hotel”
- Aan/uit: Bediening Aan/Uit
- Mode: Instelling bedieningsmodus
- Tmp.instell.: Instelling vooraf ingestelde temp.
- Waaier: Waaierinstelling
- Menu: Menu-instelling
- Ventil: Ventilatorsnelheidinstelling
- Lamel: Lamelinstelling

Wanneer “Hotel” wordt geselecteerd voor de instelling “Locatie”, worden de volgende bedieningen automatisch vergrendeld: Mode, Waaier, Menu en Lamel.

Druk op de toets **SELECTEREN** als u de instellingen wilt opslaan.

Er verschijnt een bevestigingsscherm.

Navigeren door de schermen

- Terug naar het Hoofdmenu **MENU** toets
- Terug naar het vorige scherm **TERUG** toets

Functie-instellingen



 verschijnt op het Statusdisplay en het Hoofddisplay in de modus Volledig wanneer de functie Bedieningsvergrendeling is ingeschakeld.

De bedieningsgids die hoort bij de vergrendelde functie wordt onderdrukt.

Houd de toets **Instelling** ten minste tien seconden ingedrukt om het Hoofdmenu weer te geven terwijl de menu-instelling is vergrendeld. Voer het beheerderswachtwoord in op het wachtwoordinvoerscherm.

Automatisch terug naar de vooraf ingestelde temperatuur

Nadat de functie Auto terug is ingeschakeld, wanneer de bedieningsmodus wijzigen of AAN/UIT-operatie wordt uitgevoerd met deze afstandsbediening, keert de ingestelde temperatuur automatisch terug naar de gewenste temperatuur, ongeacht de ingestelde tijd.

Bediening van toetsen

1

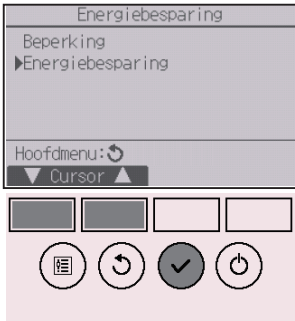

Selecteer “Energiebesparing” in het menu
Energiebesparing en druk op de toets **[SELECTEREN]**.

2



De actuele instellingen verschijnen.

Verplaats de cursor met toets **[F1]** of **[F2]** naar “Auto terug” en druk op de toets **[SELECTEREN]**.

Functie-instellingen

3



Het scherm voor het invoeren van instellingen voor het automatisch terugkeren naar de vooraf ingestelde temperatuur verschijnt.

Verplaats de cursor met toets **[F1]** of **[F2]** naar “Auto terug”, “Koelen”, of “Verwarmen”.

4



Wijzig de instellingen met toets **[F3]** of **[F4]**.

- Auto terug: Nee (uitschakelen)/Ja (inschakelen)
- Koelen: het bereik voor de timerinstelling is 30 tot 120 minuten in stappen van 10 minuten.
Het instelbereik voor de temperatuur is 19 tot 30°C (67 tot 87°F) (stappen van 1°C).
- Verwarmen: het bereik voor de timerinstelling is 30 tot 120 minuten in stappen van 10 minuten.
Het instelbereik voor de temperatuur is 17 tot 28°C (63 tot 83°F) (stappen van 1°C).

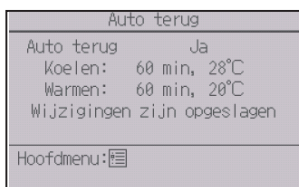

Druk op de toets **[SELECTEREN]** als u de instellingen wilt opslaan. “Koelen” omvat de modi “Drogen” en “Auto Koelen” en “Warmen” omvat de modus “Auto Warmen”. Het scherm voor het instellen van het geselecteerde item verschijnt.

Navigeren door de schermen

- Terug naar het Hoofdmenu **[MENU]** toets
- Terug naar het vorige scherm **[TERUG]** toets

De instellingen van timer of vooraf ingestelde temperatuur zullen niet effectief zijn wanneer het temperatuurbereik beperkt is en wanneer het systeem centraal wordt geregeld (wanneer de instelling van het temperatuurbereik vanaf de lokale afstandsbediening niet is toegestaan). Wanneer het systeem centraal wordt geregeld (wanneer timer functie instelling vanaf de lokale afstandsbediening niet is toegestaan), wordt alleen de timer-instelling niet werkzaam.

Het bedieningsschema voor energiebesparing instellen

Bediening van toetsen

1



Ga naar het instelscherm “Energiebesparing”.
(Raadpleeg pagina 49.)

Verplaats de cursor naar “Schema” en druk op de toets **SELECTEREN**.

2



U kunt het schema zien in het scherm dat verschijnt.

Wanneer u op toets **F1** of **F2** drukt, kunt u de instellingen voor elke dag van de week zien.

Druk op de toets **SELECTEREN** als u naar het instelscherm wilt gaan.

3



U kunt het bedieningsschema Energiebesparing inschakelen (Ja) / uitschakelen (Nee) in het scherm dat verschijnt.

Selecteer “Nee” of “Ja” met toets **F3** of **F4**.

Druk op de toets **SELECTEREN** en ga naar het selectiescherm voor het instellen van verandering/ dag van de week.

Functie-instellingen

4



Het selectiescherm voor het instellen van verandering/dag van de week verschijnt.

Per dag kunnen maximaal vier patronen voor de bediening worden ingesteld.

Verplaats met toets **F1** of **F2** de cursor naar de dag van de week en selecteer deze door op toets **F3** te drukken. (U kunt meerdere dagen selecteren.)

Druk op de toets **SELECTEREN** als u naar het instelscherm voor patronen wilt gaan.

5



Het instelscherm voor patronen verschijnt.

Verplaats de cursor met toets **F1** naar het nummer van het patroon van uw keuze.

Verplaats de cursor met toets **F2** naar starttijd, stoptijd en mate van energiebesparing (gerangschikt in deze volgorde vanaf links).

Wijzig de instellingen met toets **F3** of **F4**.

- Start-/Stoptijd: in te stellen in stappen van 5 minuten
* Houd de toets ingedrukt als u de nummers snel vooruit wilt laten lopen.
- Energiebesparingspercentage: Het instelbereik is 0% en 50 tot 90% in stappen van 10%.

Druk op de toets **SELECTEREN** als u de instellingen wilt opslaan.

Er verschijnt een bevestigingsscherm.

Hoe lager de waarde, des te groter het energiebesparende effect.



 verschijnt in het Statusdisplay en het Hoofddisplay in de stand Volledig wanneer de unit wordt bediend in de modus voor energiebesparing.

Navigeren door de schermen

- Terug naar het selectiescherm wijziging instelling/dag van de week..... **[SELECTEREN]** toets
- Terug naar het Hoofdmenu **[MENU]** toets
- Terug naar het vorige scherm..... **[TERUG]** toets

Functie-instellingen

Klok



Bediening van toetsen

1



Selecteer “Initiële instelling” in het Hoofdmenu (raadpleeg pagina 24) en druk op de toets **[SELECTEREN]**.

U kunt de volgende instellingen pas uitvoeren als de klok is een gesteld.

- Aan/uit-timer
- Weekklok
- Stille stand buitenunit
- Energiebesparing
- Nachtverlaging

Als een bepaald systeem geen systeemregeleenheden heeft, wordt de kloktijd niet automatisch gecorrigeerd. In dit geval dient u de kloktijd periodiek te corrigeren.

2



Verplaats de cursor met toets **[F1]** of **[F2]** naar “Basisinstelling” en druk op de toets **[SELECTEREN]**.

3



Selecteer “Klok” met de toets **[F1]** of **[F2]** en druk op de toets **[SELECTEREN]**.

4



Verplaats de cursor met toets **[F1]** of **[F2]** naar “Klok” en druk op de toets **[SELECTEREN]**.

5



Verplaats de cursor met toets **[F1]** of **[F2]** naar jaar, maand, datum of minuut.

Verlaag of verhoog de waarde voor het geselecteerde item met de toets **[F3]** of **[F4]** en druk op de toets **[SELECTEREN]**.

Er verschijnt een bevestigingsscherm.

Navigeren door de schermen

- Terug naar het Hoofdmenu **[MENU]** toets
- Om terug te gaan naar het vorige scherm **[TERUG]** toets

Functie-instellingen

Zomertijd



Omschrijving van de functies

De starttijd/eindtijd voor de zomertijd kan worden ingesteld. De zomertijdfunctie wordt volgens deze instelling geactiveerd.

- Als een bepaald systeem een systeemregeleenheid heeft, schakelt u deze instelling uit om de correcte tijd te behouden.
- Aan het begin en het einde van de zomertijd wordt de timer mogelijk twee keer of helemaal niet geactiveerd.
- Deze functie werkt alleen als de klok is ingesteld.

Bediening van toetsen

1



Selecteer "Klok" in het menu Basisinstellingen en druk op de toets **[SELECTEREN]**.

2



Verplaats de cursor met toets **[F1]** of **[F2]** naar "Zomertijd" en druk op de toets **[SELECTEREN]**.

3



Verplaats de cursor met toets **[F1]** naar de volgende items om de instellingen uit te voeren.

- **Zomertijd**
Selecteer “Nee” (uitschakelen) of “Ja” (inschakelen) met de toets **[F2]**. De standaardinstelling is “Nee”.
- **Datum(start)*1**
Stel de dag van de week, het weeknummer en de maand in met de toets **[F3]** of **[F4]**. De standaardinstelling is “Zon/5e/Maa”.
- **Starttijd**
Stel met de toets **[F3]** of **[F4]** de starttijd voor de zomertijd in.
- **Sturen naar**
Stel met de toets **[F3]** of **[F4]** de tijd in waarnaar de klok op de starttijd vooruit wordt gezet.
- **Datum(einde)*1 (2e pagina)**
Stel de dag van de week, het weeknummer en de maand in met de toets **[F3]** of **[F4]**. De standaardinstelling is “Zon/5e/Okt”.
- **Eindtijd (2e pagina)**
Stel met de toets **[F3]** of **[F4]** de eindtijd voor de zomertijd in.
- **Terug naar (2e pagina)**
Stel met de toets **[F3]** of **[F4]** de tijd in waarnaar de klok op de eindtijd achteruit wordt gezet.

*1 Als u het weeknummer instelt op “5e” maar de geselecteerde maand geen 5e week heeft, wordt de instelling “4e” gebruikt.

Druk op de toets **[SELECTEREN]** als u de instellingen wilt opslaan.

Er verschijnt een bevestigingsscherm.

Navigeren door de schermen

- Terug naar het Hoofdmenu **[MENU]** toets
- Terug naar het vorige scherm **[TERUG]** toets

Functie-instellingen

Hoofddisplay



Bediening van toetsen

1



Selecteer “Display-instelling” in Begininstellingen en druk op de toets **[SELECTEREN]**.

2



Verplaats de cursor met toets **[F1]** of **[F2]** naar “Hoofddisplay” en druk op de toets **[SELECTEREN]**.

3



Selecteer “Volledig” of “Basis” (raadpleeg pagina 10) met toets **[F3]** of **[F4]** en druk op de toets **[SELECTEREN]**.

Er verschijnt een bevestigingsscherm.

Navigeren door de schermen

- Terug naar het Hoofdmenu **[MENU]** toets
- Terug naar het vorige scherm **[TERUG]** toets

Bediening van toetsen

1



Selecteer “Display-instelling” in Begininstellingen en druk op de toets **SELECTEREN**.

2



Verplaats de cursor met toets **F1** of **F2** naar “Hoofddisplay” en druk op de toets **SELECTEREN**.

3



Selecteer “Pictogramuitleg” met de toets **F1** of **F2**, selecteer de gewenste instelling “Ja” of “Nee” met de toets **F3** of **F4** en druk op de toets **SELECTEREN**. De standaardinstelling is “Ja”.

Navigeren door de schermen

- Terug naar het Hoofdmenu **MENU** toets
- Terug naar het vorige scherm **TERUG** toets

Functie-instellingen

4

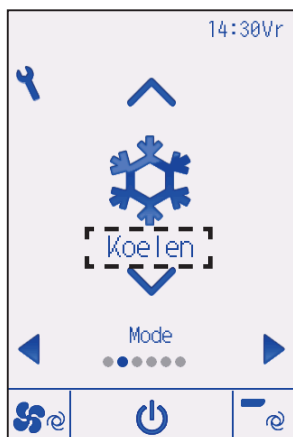

Wanneer “Ja” wordt geselecteerd, verschijnt de uitleg van het pictogram van het instellingsitem zoals links weergegeven.

Bediening van toetsen

1



Selecteer "Display-instelling" in Begininstellingen en druk op de toets **[SELECTEREN]**.

2



Verplaats de cursor met toets **[F1]** of **[F2]** naar "Helderheid" en druk op de toets **[SELECTEREN]**.

3



Pas de helderheid aan met toets **[F1]** of **[F2]**. Met de toets **[F4]** kan "AAN" of "UIT" worden geselecteerd voor de instelling "Blijft aan".

Wanneer "AAN" wordt geselecteerd, blijft de achtergrondverlichting gedimd branden, ook nadat de ingestelde tijd is verstreken.

Navigeren door de schermen

- Terug naar het Hoofdmenu **[MENU]** toets
- Terug naar het vorige scherm **[TERUG]** toets

Functie-instellingen

Taalkeuze



Omschrijving van de functies

U kunt de taal van uw keuze instellen. De taalopties zijn Engels, Frans, Duits, Spaans, Italiaans, Portugees, Zweeds, Russisch, Grieks, Turks, Nederlands, Tsjechisch, Hongaars en Pools.

Bediening van toetsen

1



Selecteer “Display-instelling” in Begininstellingen en druk op de toets **[SELECTEREN]**.

2



Verplaats de cursor met toets **[F1]** of **[F2]** naar “Taalkeuze” en druk op de toets **[SELECTEREN]**.

3



Verplaats met toets **[F1]** tot en met **[F4]** de cursor naar de taal van uw keuze en druk op de toets **[SELECTEREN]** als u de instelling wilt opslaan.

Als het apparaat voor het eerst ingeschakeld wordt, verschijnt het taalkeuzescherf. Selecteer de taal van uw keuze. Het systeem start niet op als u geen taal selecteert.

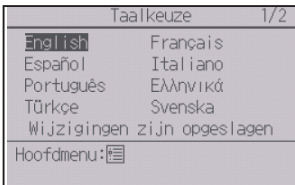

Er verschijnt een scherm waarop wordt aangeduid dat de instelling is opgeslagen.

Navigeren door de schermen

- Terug naar het Hoofdmenu **[MENU]** toets
- Terug naar het vorige scherm **[TERUG]** toets

Functie-instellingen

Ontwerp



Bediening van toetsen

1



Selecteer “Display-instelling” in Begininstellingen en druk op de toets **[SELECTEREN]**.

2



Verplaats de cursor met toets **[F1]** of **[F2]** naar “Ontwerp” en druk op de toets **[SELECTEREN]**.

3



Selecteer “Kleur” met toets **[F4]**.

- **Kleur:** De schermkleur kan worden geselecteerd. (Zie volgende pagina.)
- **Wit:** Monochroomscherm (witte basis)
- **Zwart:** Monochroomscherm (zwarte basis)

Druk op de toets **[SELECTEREN]** wanneer “Wit” of “Zwart” wordt geselecteerd. Selecteer de gewenste kleur (zie volgende pagina) wanneer “Kleur” wordt geselecteerd.

4



Selecteer het volgende item met de toets **F1** of **F2** en stel de gewenste schermkleur voor elk item in.

- Kleurschakering: Stel de kleurschakering in met de toets **F3** of **F4**. (Het instelbare bereik is -90 tot en met 89.)
- Patroon: Stel de kleur in met de toets **F4**.
- Kleur is: Selecteer met de toets **F4** "Tekens" of "Achtergrond" als doel waarop de kleur wordt toegepast.

De voorbeeldkleur onder de functietoetsen verandert in overeenstemming met de instelling.

Stel de gewenste kleur in en druk op de toets **SELECTEREN**.

Navigeren door de schermen

- Terug naar het Hoofdmenu **MENU** toets
- Om terug te gaan naar het vorige scherm **TERUG** toets

Functie-instellingen

Aanraakpaneel kalibratie



Bediening van toetsen

1



Selecteer “Aanraakpaneel” in de Begininstellingen en druk op de toets **[SELECTEREN]**.

2



Verplaats de cursor met toets **[F1]** of **[F2]** naar “Aanraakpaneel kalibratie” en druk op de toets **[SELECTEREN]**.

3



Er verschijnt een bevestigingsscherm. Selecteer met de toets **[F3]** of **[F4]** “Annul” of “OK” en druk op de toets **[SELECTEREN]**.

4

Tik op de zwarte punten in devolgorde waarin ze op het scherm verschijnen. Er zijn er negen in totaal.

Raak de zwarte punten binnen één minuut met een aanraakpen aan. Begin in de linker bovenhoek.

Tik op de negen zwarte punten in de volgorde waarin ze op het scherm verschijnen.

Wanneer alle negen zwarte punten zijn aangeraakt, is de kalibratie voltooid en gaat het display terug naar het menu aanraakpaneel.

- Als het aanraakpaneel een minuut lang niet wordt aangeraakt, wordt de kalibratie geannuleerd en keer het display automatisch terug naar het vorige scherm.
- Om het aanraakpaneel goed te kalibreren, kunt u voor het aanraken van de punten het beste gebruik maken van een puntig maar niet scherp voorwerp.
 - * Een scherp voorwerp kan het aanraakpaneel beschadigen of bekrassen.

Functie-instellingen

Aanraakpaneel reinigen



Bediening van toetsen

1



Selecteer “Aanraakpaneel” in Begininstellingen en druk op de toets **[SELECTEREN]**.

2



Verplaats de cursor met toets **[F1]** of **[F2]** naar “Aanraakpaneel reinigen” en druk op de toets **[SELECTEREN]**.

3



Er verschijnt een bevestigingsscherm. Selecteer met de toets **[F3]** of **[F4]** “Annuleren” of “OK” en druk op de toets **[SELECTEREN]**.

4



Met dit scherm voor zich kan de gebruiker het aanraakpaneel gedurende 30 seconden afnemen zonder per ongeluk de instellingen te wijzigen. Na de genoemde 30 seconden keert het display terug naar het menu aanraakpaneel.

- Het scherm afnemen met een zachte droge doek, een doek die is natgemaakt in een mild reinigingsmiddel of een doek die is bevochtigd met ethanol. Gebruik geen zure, alkalische of organische oplosmiddelen.

Functie-instellingen

Afstandsbediening initialiseren



Omschrijving van de functies

De afstandsbediening kan worden geïnitieerd naar de fabriekstoestand bij verzending. De onderstaande gegevens worden geïnitieerd.

Na het initialiseren wordt de afstandsbediening automatisch opgestart.

Instelling timer, instelling wekklok, instelling stille stand buitenunit, instelling energiebesparing, instelling energiebesparingsoptie, instelling klok, instelling zomertijd, instelling hoofddisplay, instelling helderheid, instelling details, instelling ontwerp, instelling auto-stand, instelling modelnaam, instelling serienummer, instelling dealerinformatie, informatie over fout, beheerderswachtwoord, onderhoudswachtwoord

Bediening van toetsen

1



Selecteer “Overige” onder Service en druk op de toets **SELECTEREN**.

2

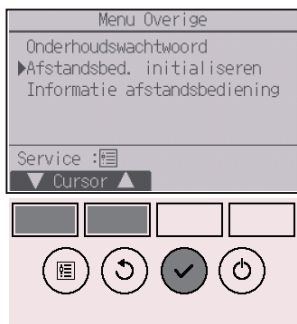

Verplaats de cursor met toets **F1** of **F2** naar “Afstandsbediening initialiseren” en druk op de toets **SELECTEREN**.

3



Selecteer "OK" met toets **[F4]**.



Na het initialiseren wordt de afstandsbediening automatisch opgestart.

Functie-instellingen

Informatie afstandsbediening



Omschrijving van de functies

Op de afstandsbediening die in gebruik is kan de informatie worden gecontroleerd.

Bediening van toetsen

1



Selecteer “Overige” onder Service en druk op de toets **SELECTEREN**.

2

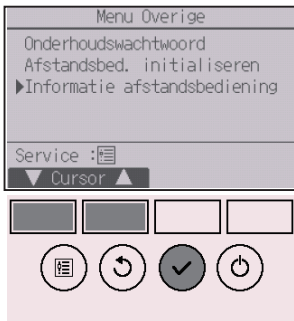

Verplaats de cursor met toets **F1** of **F2** naar “Informatie afstandsbediening” en druk op de toets **SELECTEREN**.

3

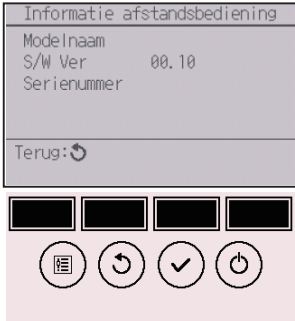

Van de afstandsbediening die in gebruik is kan de modelnaam, de softwareversie en het serienummer worden gecontroleerd.

Oplossen van problemen

Informatie over fout

Wanneer zich een fout voordoet, verschijnt het volgende scherm en knippert de bedrijfs-LED. Controleer de foutstatus, stop de werking van het systeem en vraag advies aan uw dealer.

Bediening van toetsen

1



De foutcode, de unit met de fout, het koeladres, het modelnaam van de unit, de datum en het tijdstip waarop een fout zich heeft voorgedaan en het serienummer verschijnen.

De modelnaam en het serienummer verschijnen alleen als deze informatie is geregistreerd.

Druk op toets **F1** of **F2** als u naar de volgende pagina wilt gaan.

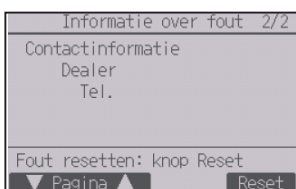

Contactinformatie (telefoonnummer van de dealer) verschijnt als deze informatie is geregistreerd.

2



Druk op toets **[F4]** of **[AAN/UIT]** om de optredende fout te resetten.

Fouten kunnen niet worden gereset zolang AAN/UIT-bediening niet is toegestaan.



Selecteer "OK" met toets **[F4]**.



Er verschijnt een bevestigingsscherm.

Navigeren door de schermen

- Terug naar het Hoofdmenu **[MENU]** toets

Oplossen van problemen

De informatie over fout controleren

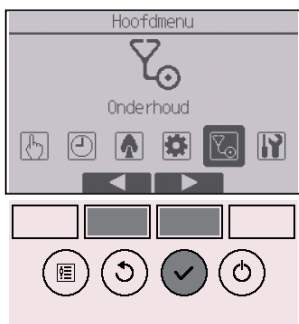

Zolang zich geen fouten voordoen, kan pagina 2/2 van de informatie over fout (raadpleeg pagina 74) worden bekeken vanuit de menubediening. Selecteer “Onderhoudsmenu” in het Hoofdmenu en druk op de toets **SELECTEREN**.

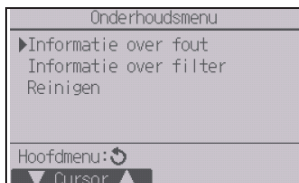

Selecteer “Informatie over fout” in het Onderhoudsmenu om het scherm informatie over fout weer te geven. Fouten kunnen niet worden gereset.

Auto-UIT bij afwezigheid

Het volgende scherm verschijnt voor het paneel model 3D i-See sensor wanneer de unit wordt uitgeschakeld vanwege de functie Auto-UIT bij afwezigheid in de energiebesparingsoptie.

Raadpleeg de instructiehandleiding van de binnenunit voor de 3D i-See sensor instelling.

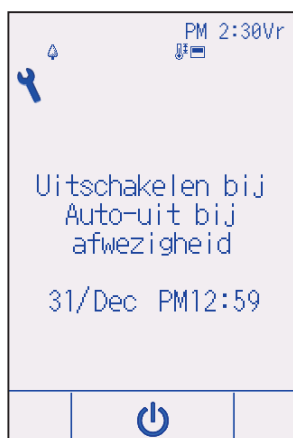

Onderhoud

Informatie over filter



 verschijnt op het Statusdisplay en het Hoofddisplay in de stand Volledig wanneer het tijd is voor het reinigen van de filters.

Was, reinig of vervang de filters wanneer dit teken verschijnt.

Raadpleeg de installatiehandleiding van de binneneenheid voor nadere bijzonderheden.

Bediening van toetsen

1

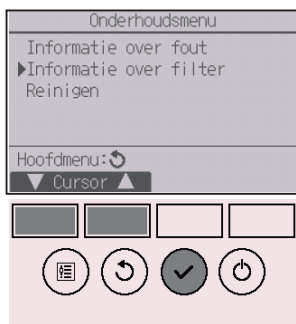

Selecteer “Informatie over filter” in het Onderhoudsmenu en druk op de toets **SELECTEREN**.

2



Druk op toets **F4** als u de filtermarkering wilt resetten.

In de Instructiehandleiding van de binneneenheid vindt u instructies voor het reinigen van het filter.

3



Selecteer “OK” met toets [F4].

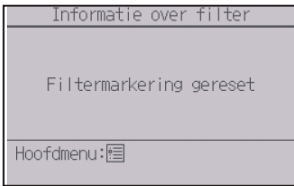

Er verschijnt een bevestigingsscherm.

Navigeren door de schermen

- Terug naar het Hoofdmenu [MENU] toets
- Terug naar het vorige scherm [TERUG] toets



Wanneer  wordt getoond op het Statusdisplay en het Hoofddisplay in de stand Volledig, wordt het systeem centraal geregeld en kan de filtermarkering niet worden gereset.

Als twee of meer binnenunits zijn aangesloten, kan afhankelijk van het type filter de timing voor het reinigen van het filter voor de beide units verschillen.

Het pictogram  verschijnt wanneer het filter op de hoofdunit moet worden gereinigd.

Wanneer de filtermarkering wordt gereset, wordt de cumulatieve werkingstijd van alle units gereset.

Het pictogram  verschijnt normaal gesproken na een bepaalde werkingsduur, waarbij ervan wordt uitgegaan dat de binnenunits zijn geïnstalleerd in een ruimte met een gewone luchtkwaliteit. Afhankelijk van de luchtkwaliteit zal de filter misschien vaker moeten worden gereinigd.

De cumulatieve tijd voor de reiniging van filters is afhankelijk van het model.

Specificaties

Specificaties afstandsbediening

	Specificatie
Afmeting van het product	Standaard (PAR-CT01MAA(R)-SB/PAR-CT01MAA-S): 65(b) × 120(h) × 14,1(d) mm (2 9/16 × 4 23/32 × 9/16 [in]) (het uitstekende gedeelte niet inbegrepen)
	Premium (PAR-CT01MAA(R)-PB): 68(b) × 120(h) × 14,1(d) mm (2 11/16 × 4 23/32 × 9/16 [in]) (het uitstekende gedeelte niet inbegrepen)
Nettogewicht	Standaard (PAR-CT01MAA(R)-SB/PAR-CT01MAA-S): 0,09 kg (13/64 lbs)
	Premium (PAR-CT01MAA(R)-PB): 0,10 kg (7/32 lbs)
Nominale voedingsspanning	12 VDC (geleverd door binnenunits)
Stroomverbruik	0,6 W
Gebrieksomgeving	Temperatuur 0 ~ 40°C (32 ~ 104°F) Vochtigheid 25 ~ 90% RV (zonder condens)
Materiaal	Standaard (PAR-CT01MAA(R)-SB/PAR-CT01MAA-S) Hoofdtoestel: ABS
	Premium (PAR-CT01MAA(R)-PB) Hoofdtoestel: ABS Zijplaat: aluminium

Funcielijst (stand 1 oktober 2017)

○ : Ondersteund × : Niet-ondersteund

	Functie	CITY MULTI	Mr. SLIM	Vereist wachtwoord
Voedings- instellingen	AAN/UIT	○	○	-
	Bedieningsmodus	○	○	-
	Auto modus (tweevoudig instelpunt)	○	○	-
	Vooraf ingestelde temperatuur	○	○	-
	Ventilatorsnelheid	○	○	-
	Waaier	○	○	-
	Lamel	○	○	-
	Ventilatie	○	○	-
Menu bediening	Hoog vermogen	×	○	-
	Handmatige hoek waaier	○	○	-
	3D i-See sensor	○	○	-
Timermenu	Timer (Aan/uit-timer)	○	○	beheerder
	Timer (Auto-uit-timer)	○	○	beheerder
	Weekklok	○	○	beheerder
	Stille stand buitenunit	○	○	beheerder
	Nachtverlaging	○	○	beheerder
Menu energiebesparing	Temperatuurbereikbeperking	○	○	beheerder
	Functie bedieningsvergrendeling	○	○	beheerder
	Auto terug	○	○	beheerder
	Schema	×	○	beheerder
Begininstellingen	Klok	○	○	beheerder
	Instelling indeling klokweergave	○	○	beheerder
	Zomertijd	○	○	beheerder
	Hoofddisplay	○	○	beheerder
	Pictogramuitleg	○	○	beheerder
	Helderheid	○	○	beheerder
	Taalkeuze	○	○	beheerder
	Ontwerp	○	○	beheerder
	Aanraakpaneel kalibratie	○	○	beheerder
	Aanraakpaneel reinigen	○	○	beheerder
Wachtwoord (beheerder)	○	○	beheerder	
Service	Afstandsbediening initialiseren	○	○	onderhoud
	Informatie afstandsbediening	○	○	onderhoud
	Proefdraaien	○	○	onderhoud
	Modelinformatie invoeren	○	○	onderhoud
	Dealerinformatie invoeren	○	○	onderhoud
	Functie-instelling	○	○	onderhoud
	Vlot onderhoud	×	○	onderhoud
	Wachtwoord (onderhoud)	○	○	onderhoud
Onderhoudsmenu	Auto dalend rooster	○	○	-
	Informatie over fout	○	○	-
	Informatie over filter	○	○	-

* Welke functies worden ondersteund is afhankelijk van het model van de unit.

Specificaties

Lijst van functies die in combinatie/niet in combinatie kunnen worden gebruikt

	Hoog vermogen	Aan/uit-timer	Auto-uit-timer	Weekklok	Stille stand buitenunit	Temperatuurbereik	Bedieningsvergendeling	Auto terug	Energiebesparings-schema	Nachtverlaging
Hoog vermogen		○	○	○	△ 1	○	△ 2	○	△ 1	○
Aan/uit-timer	○		○	× 1	○	○	○	○	○	△ 3
Auto-uit-timer	○	○		○	○	○	○	○	○	△ 4
Weekklok	○	× 1	○		○	○	○	○	○	△ 5
Stille stand buitenunit	△ 1	○	○	○		○	○	○	○	○
Temperatuurbereik	○	○	○	○	○		○	× 2	○	△ 6
Bedieningsvergendeling	△ 2	○	○	○	○	○		○	○	○
Auto terug	○	○	○	○	○	× 2	○		○	△ 7
Energiebesparings-schema	△ 1	○	○	○	○	○	○	○		○
Nachtverlaging	○	△ 3	△ 4	△ 5	○	△ 6	○	△ 7	○	

○ : Kunnen in combinatie worden gebruikt × : Kunnen niet in combinatie worden gebruikt △ : Beperkt

△ 1: Deze functie wordt ingeschakeld na de hoog-vermogenwerking omdat de hoog-vermogenwerking een hogere prioriteit heeft.

△ 2: Deze functie kan niet worden gebruikt als een bepaalde bedieningshandeling is vergrendeld.

△ 3: De functie Nachtverlaging kan niet worden gebruikt wanneer de unit in werking is op basis van een instelling van de Aan/uit-timer.

△ 4: De functie Auto-uit kan niet worden gebruikt voor de Nachtverlaging.

△ 5: De functie Nachtverlaging kan niet worden gebruikt wanneer de unit in werking is op basis van een instelling van de Weekklok.

△ 6: De temperatuurbereikinstelling kan niet worden gebruikt voor de Nachtverlaging.

△ 7: De functie Auto terug kan niet worden gebruikt voor de Nachtverlaging.

× 1: De weekklokinstelling is niet effectief omdat de Aan/uit-timer een hogere prioriteit heeft.

× 2: De functie Auto terug kan niet worden gebruikt omdat de Temperatuurbereikinstelling een hogere prioriteit heeft.

Система управления CITY MULTI
и кондиционеры Mitsubishi Mr. SLIM

Сенсорный контроллер дистанционного управления MA

PAR-CT01MAA-PB

PAR-CT01MAA-SB

PAR-CT01MAA-S

PAR-CT01MAR-PB

PAR-CT01MAR-SB

Руководство по эксплуатации

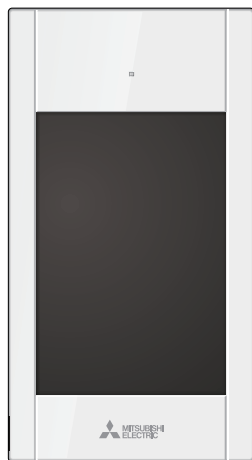

Русский

Чтобы эксплуатировать это изделие правильным образом, перед использованием внимательно прочтите указания, приведенные в этом руководстве. Сохраните руководство для использования в качестве справочника в дальнейшем. Следите, чтобы этот компакт-диск и руководство по установке были переданы всем будущим пользователям.



Для обеспечения безопасной и правильной работы контроллера его установку должен выполнять квалифицированный специалист.

Содержание

Меры предосторожности	4
Компоненты контроллера	6
Интерфейс контроллера — экран Состояния / Основной экран	6
Интерфейс контроллера — экран меню	8
Экран — экран Состояния / Основной экран	10
Структура и значки меню	12
Структура меню	12
Описание значков	15
Основные операции	16
ВКЛ/ВЫКЛ питания	16
Настройки режима работы, температуры, скорости вентилятора, угла, жалюзи и вентиляции (Lossnay)	17
Навигация по меню	22
Список Главного меню	22
Навигация по Главному меню	24
Настройки функций	25
Максимальная мощность	25
Ручная установка угла	26
Таймер (Таймер ВКЛ/ВЫКЛ)	29
Таймер (Автоотключение таймера)	32
Таймер на неделю	34
Тихий режим	37
Ночной режим	40
Ограничение	43
Энергосбережение	49
Часы	54
Летнее время	56
Основной экран	58
Описание значков	59
Яркость	61
Выбор языка	62
Дизайн	64
Калибровка сенсорной панели	66
Чистка сенсорной панели	68
Сброс дистанционного управления	70
Информации о дистанционном управлении	72
Устранение неисправностей	74
Информация о неисправностях	74
Автоотключение при незанятости	77
Отладка	78
Информация о фильтре	78
Технические характеристики	80
Технические характеристики контроллера	80
Список функций (по состоянию на 1 октября 2017 года)	81
Список функций, которые могут (не могут) использоваться в сочетании	82

Меры предосторожности

- Внимательно прочтите следующие правила техники безопасности перед использованием изделия.
- Для обеспечения безопасности строго соблюдайте указанные меры.

 ПРЕДОСТЕРЕЖЕНИЕ	Указывает на опасность смертельного исхода или получения тяжелой травмы.
 ВНИМАНИЕ	Указывает на опасность получения тяжелой травмы или повреждения оборудования.

- После прочтения данного руководства передайте его конечному пользователю для последующего использования в качестве справочного документа.
- Храните руководство для последующего использования в качестве справочного документа и обращайтесь к нему при необходимости. Руководство должно быть доступно для персонала, выполняющего ремонт или переименование контроллера. Передавайте руководство всем будущим пользователям.

Общие предостережения

ПРЕДОСТЕРЕЖЕНИЕ

Не устанавливайте контроллер в местах высокой концентрации масла, пара, органических растворителей или таких коррозионных газов, как сернистый газ, в местах частого использования кислотных или щелочных растворов или аэрозолей. Эти вещества могут снизить эффективность работы контроллера или вызывать коррозию отдельных составных частей контроллера, что в свою очередь может привести к поражению персонала электрическим током, возникновению неисправностей, образованию дыма или возгоранию.

Для снижения опасности возникновения коротких замыканий, утечки тока, поражения электрическим током, возникновения неисправностей, образования дыма и возгорания не мойте контроллер водой или другими жидкостями.

Для снижения опасности возникновения коротких замыканий, утечки тока, поражения электрическим током, возникновения неисправностей, образования дыма и возгорания не прикасайтесь к переключателям, кнопкам и электрическим узлам мокрыми руками.

При выполнении дезинфекции изделия с использованием спиртосодержащих веществ должна быть обеспечена соответствующая вентиляция помещения. Пары алкоголя вокруг изделия могут стать причиной пожара или взрыва при включении устройства.

ВНИМАНИЕ

Для снижения опасности возгорания и взрыва не оставляйте легковоспламеняющиеся материалы и не распыляйте легковоспламеняющиеся аэрозоли вблизи контроллера.

Для снижения опасности повреждения контроллера не распыляйте инсектициды или другие легковоспламеняющиеся аэрозоли на контроллер.

Для снижения опасности получения травмы или поражения электрическим током перед распылением химических веществ вблизи контроллера выключите контроллер и накройте его.

Для снижения опасности получения травмы или поражения электрическим током перед очисткой, техническим обслуживанием или проверкой контроллера выключите контроллер и отключите источник питания.

При обнаружении признаков неисправностей (например, запаха горелой изоляции) прекратите эксплуатацию, переведите выключатель питания в выключенное положение и обратитесь к дилеру. Продолжение эксплуатации изделия может привести к поражению электрическим током, неисправности или пожару.

Правильно устанавливайте все крышки, чтобы влага и пыль не попадали в контроллер. Попадание пыли и воды может привести к поражению электрическим током, образованию дыма или возгоранию.

Для снижения риска загрязнения окружающей среды получите консультацию в полномочной организации о надлежащей утилизации контроллера дистанционного управления.

Для снижения опасности поражения электрическим током и возникновения неисправностей не используйте острые предметы для работы с сенсорной панелью, переключателями и кнопками.

Для снижения опасности получения травмы и поражения электрическим током не прикасайтесь к острым кромкам отдельных деталей.

Для снижения опасности получения травмы от разбитого стекла не прилагайте чрезмерные усилия к стеклянным деталям.

Для снижения опасности получения травмы во время работы с контроллером применяйте защитное снаряжение.

Меры предосторожности при перемещении и ремонте контроллера

ПРЕДОСТЕРЕЖЕНИЕ

Перемещение и ремонт контроллера должен проводиться квалифицированным персоналом. Не разбирайте и не модифицируйте контроллер. Неправильная установка или ремонт могут стать причиной травмы, поражения электрическим током или возгорания.

ВНИМАНИЕ

Для снижения опасности возникновения коротких замыканий, поражения электрическим током и возникновения неисправностей не прикасайтесь к печатной плате инструментами или руками и не допускайте скопления пыли на печатной плате.

Дополнительные меры предосторожности

Во избежание повреждения контроллера во время установки, проверки и ремонта пользуйтесь подходящими инструментами.

Этот контроллер предназначен для использования только с системой управления зданием разработки Mitsubishi Electric. Использование контроллера с другими системами или для других целей может стать причиной неисправностей.

Данное устройство не предназначено для использования лицами (включая детей) со сниженными физическими, сенсорными и умственными способностями, а также лицами без достаточных знаний и опыта, за исключением случаев, когда устройство используется под присмотром или руководством человека, ответственного за безопасность таких лиц. Не позволяйте детям играть с устройством.

Во избежание обесцвечивания корпуса при очистке контроллера не используйте бензин, растворители или ткани, пропитанные химическими веществами. Для очистки контроллера протрите его мягкой тканью, смоченной в воде с мягким моющим средством, удалите моющее средство влажной тканью, а затем удалите воду сухой тканью.

Во избежание повреждения контроллера обеспечьте защиту от статического электричества.

Данное устройство предназначено для использования экспертами или персоналом, прошедшим специальное обучение, в цехах, помещениях легкой промышленности или на фермах, или же в случаях коммерческого использования — неспециалистами.

Если провод питания поврежден, производитель, обслуживающий персонал производителя или квалифицированный персонал должен его заменить, чтобы исключить опасность для пользователей.

Компоненты контроллера

Интерфейс контроллера — экран Состояния / Основной экран

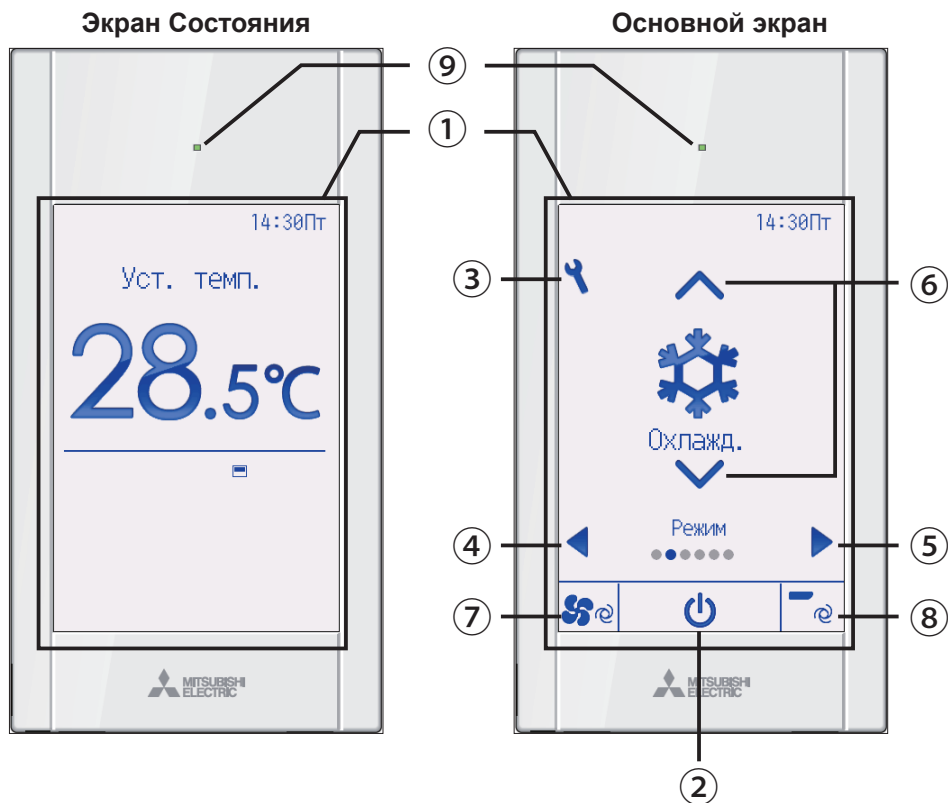

① Сенсорная панель и полноцветный жидкокристаллический экран с подсветкой

Будут отображены параметры работы. Если подсветка выключена, при нажатии любой области откроется экран Состояния. Если нажать произвольную область после отображения экрана Состояния, откроется Основной экран.

② Кнопка **ВКЛ/ВЫКЛ**

Нажмите, чтобы включить или выключить внутренний блок.

③ Кнопка **Настройки**

Нажмите, чтобы открыть Главное меню. Если установлена блокировка меню, необходимо ввести пароль администратора.

④ Кнопка ◀

Нажмите для перехода между пунктами настройки в следующем порядке: жалюзи, вентиляция, угол, скорость вентилятора, режим работы и заданная температура.

⑤ Кнопка ▶

Нажмите для перехода между пунктами настройки в следующем порядке: заданная температура, режим работы, скорость вентилятора, угол, вентиляция и жалюзи.

⑥ Кнопка ▲ ▼

Нажмите для изменения значений настроек, выбираемых в соответствии с пунктами ④ и ⑤ выше.

⑦ Кнопка быстрой регулировки скорости вентилятора

Нажмите для прямого доступа к экрану настроек скорости вентилятора.

⑧ Кнопка быстрой регулировки угла

Нажмите для прямого доступа к экрану настроек угла.

⑨ Индикатор ВКЛ/ВЫКЛ

Индикатор будет светиться зеленым цветом, если устройство находится в работе за исключением случая, когда для параметра «LED-подсветка» установлено значение «Нет». Индикатор будет мигать при включении контроллера дистанционного управления или при возникновении ошибки.

Если операция ВКЛ/ВЫК заблокирована, ② не будет отображаться.

Если при нажатии кнопок ④ или ⑤ осуществляется переход на определенный заблокированный пункт настройки, он не будет отображаться.

Если регулировка скорости вентилятора или угла заблокирована, пункт ⑦ или ⑧ не будет отображаться.

Содержимое настройки не может изменяться с помощью кнопки ⑥, если соответствующий пункт настройки централизованно управляется системным контроллером.

Компоненты контроллера

Интерфейс контроллера — экран меню

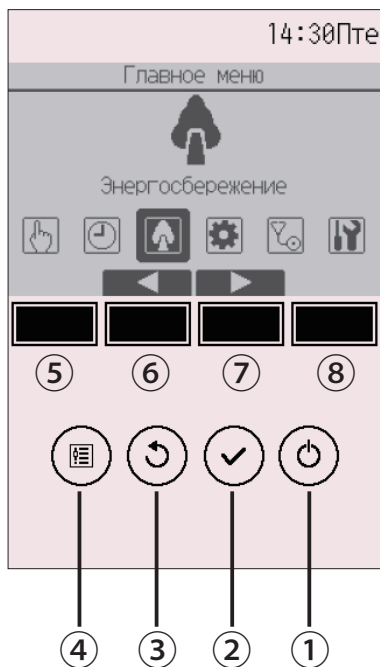

① Кнопка **ВКЛ/ВЫКЛ**

Нажмите, чтобы включить или выключить внутренний блок.

② Кнопка **ВЫБОР**

Нажмите, чтобы сохранить настройку.

③ Кнопка **ВОЗВРАТ**

Нажмите для возврата к предыдущему экрану.

При нажатии этой кнопки во время отображения Главного меню появится экран Состояния.

④ Кнопка **МЕНЮ**

Стр. 24

Нажмите, чтобы открыть Главное меню.

⑤ Функциональная кнопка **F1**

Экран меню: функция кнопки зависит от конкретного экрана.

⑥ Функциональная кнопка **F2**

Главное меню: нажмите, чтобы переместить курсор влево.

Экран меню: функция кнопки зависит от конкретного экрана.

⑦ Функциональная кнопка **F3**

Главное меню: нажмите, чтобы переместить курсор вправо.

Экран меню: функция кнопки зависит от конкретного экрана.

⑧ Функциональная кнопка **F4**

Экран меню: функция кнопки зависит от конкретного экрана.

Функции функциональных кнопок меняются в зависимости от экрана. См. подсказку по функциям кнопок, которая отображается в нижней части ЖК-экрана для функций, которые работают в данном окне.

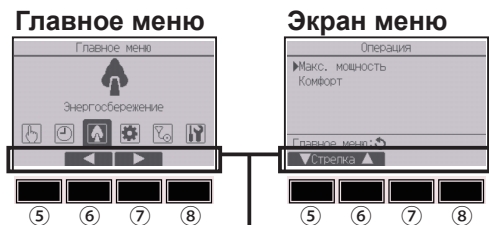

Подсказка по функциям

Компоненты контроллера

Экран — экран Состояния / Основной экран

Экран Состояния и Основной экран могут отображаться в двух различных режимах: «Полный» и «Базовый».
По умолчанию установлен режим «Полный». Переключение режимов описано на стр. 58.

Полный режим отображения

* Все значки показаны для иллюстрации и описания.

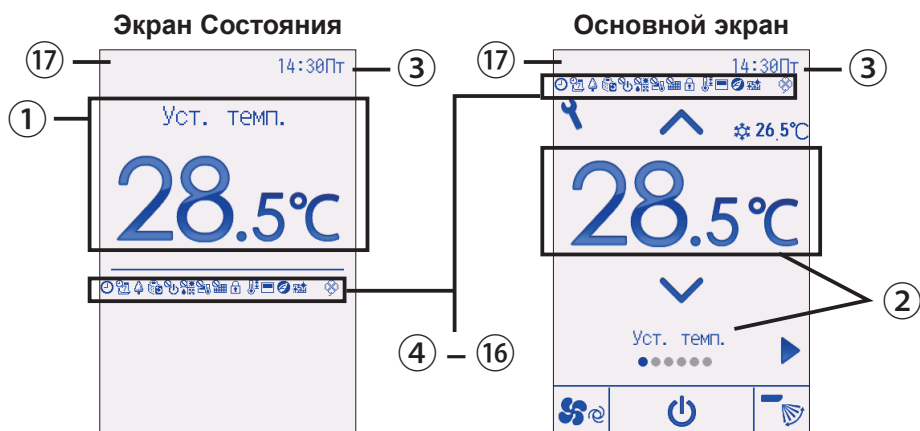

Базовый режим отображения



① Заданная температура или температура в помещении

Здесь отображается заданная температура или температура в помещении. (См. руководство по установке.)

② Пункт настройки и содержимое настройки Стр. 17

Здесь отображаются пункты настройки «Заданная температура» ↔ «Режим работы» ↔ «Скорость вентилятора» ↔ «Угол» ↔ «Вентиляция» ↔ «Жалюзи» и их содержимое. Сообщение «Центр. управление» появляется на некоторое время, когда используется элемент, управляемый централизованно.

③ Часы

Здесь отображается текущее время. (См. руководство по установке.)

④ Стр. 29, 32, 40

Отображается, когда включена функция «Таймер ВКЛ/ВЫКЛ» (стр. 29), «Ночной режим» (стр. 40) или «Автоотключение» (стр. 32) таймера.

 появляется, когда таймер отключен централизованной системой управления.

⑤ Стр. 34

Отображается, когда включен таймер на неделю.

⑥ Стр. 51

Отображается, пока изделие работает в режиме энергосбережения. (не появится на некоторых моделях внутренних блоков)

⑦ Стр. 37

Отображается, пока наружный блок работает в «тихом» режиме.

⑧

Отображается при централизованном управлении включением и выключением.

⑨

Отображается при централизованном управлении режимом работы.

⑩

Отображается при централизованном управлении заданной температурой.

⑪

Отображается при централизованном управлении функцией сброса фильтра.

⑫ Стр. 46

Отображается, когда кнопки заблокированы.

⑬ Стр. 43

Отображается, когда ограничен диапазон заданных температур.

⑭

Отображается, когда встроенный терморезистор на контроллере дистанционного управления включен для наблюдения за комнатной температурой.

 отображается, когда термистор на внутреннем блоке включен для наблюдения за комнатной температурой.

⑮

Отображается при выполнении операции энергосбережения с помощью функции «3D i-See sensor».

⑯ Стр. 78

Отображается при необходимости обслуживания фильтра.

⑰ Отображение предварительной ошибки

При возникновении предварительной ошибки отображается ее код.

Структура и значки меню

Структура меню

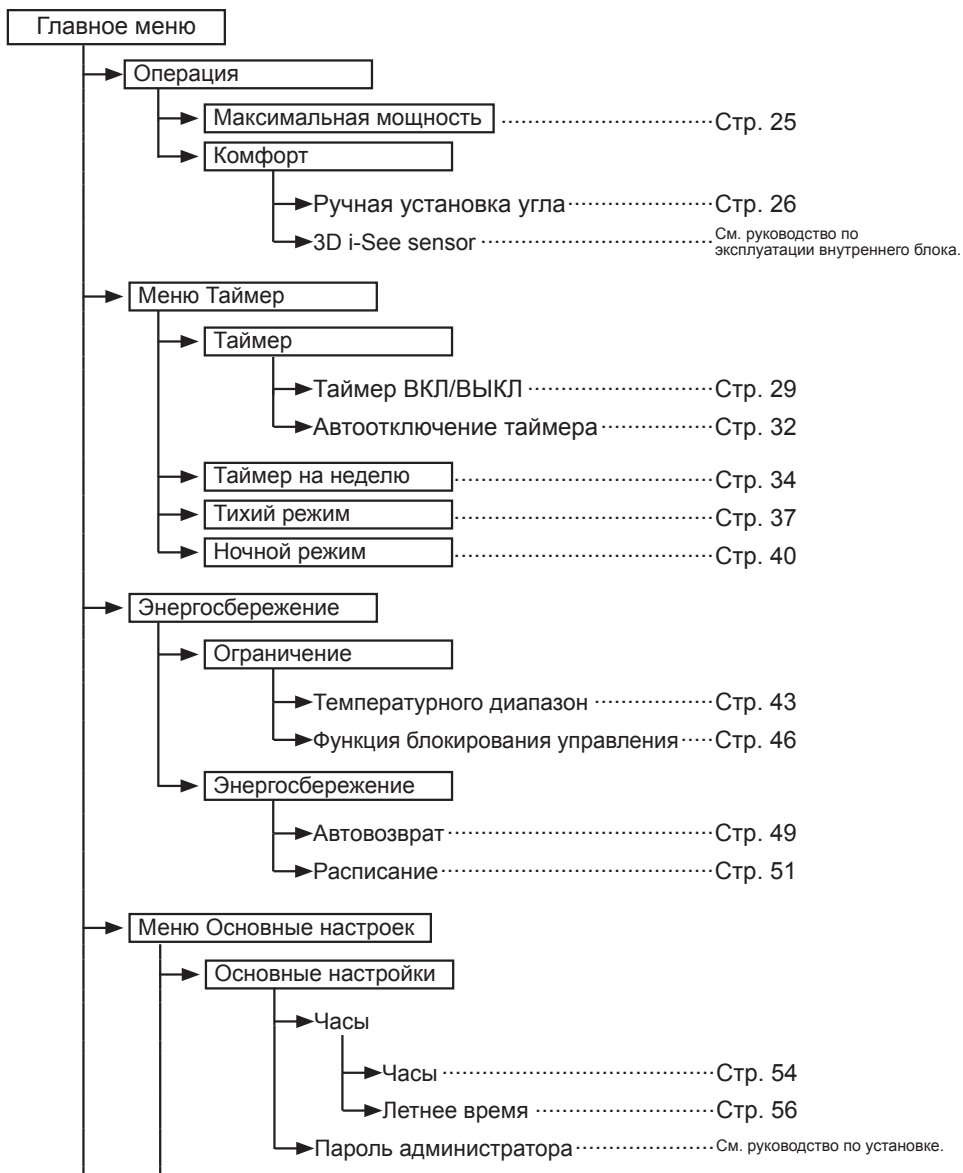

→	Настройка дисплея	
	→	Основной экран Стр. 58
	→	Информация на экране (описание значков и т. п.) См. руководство по установке.
	→	Яркость Стр. 61
	→	Выбор языка Стр. 62
	→	Дизайн Стр. 64
→	Настройка работы	
	→	Режим «Авто» См. руководство по установке.
→	Сенсорная панель	Стр. 66
→	Отладочное меню	
	→	Информация о неисправностях Стр. 74
	→	Информация о фильтре Стр. 78
	→	Чистка
		→ Автоматическое опускание панели См. руководство по установке, входящее в комплект автоматической поднимающейся панели.
		→ Операция опускания См. руководство по установке, входящее в комплект автоматической поднимающейся панели.
		→ Регулировка опускания См. руководство по установке, входящее в комплект автоматической поднимающейся панели.
→	Сервисное меню	
	→	Меню пробного пуска
		→ Пробный пуск См. руководство по установке внутреннего блока.
		→ Пробный пуск дренажного насоса См. руководство по установке внутреннего блока.
	→	Информация об отладке См. руководство по установке внутреннего блока.
		→ Ввод названия модели См. руководство по установке внутреннего блока.
		→ Ввод серийного номера См. руководство по установке внутреннего блока.
		→ Ввод информации о продавце См. руководство по установке внутреннего блока.
		→ Инициализация информации об отладке См. руководство по установке внутреннего блока.

Структура и значки меню

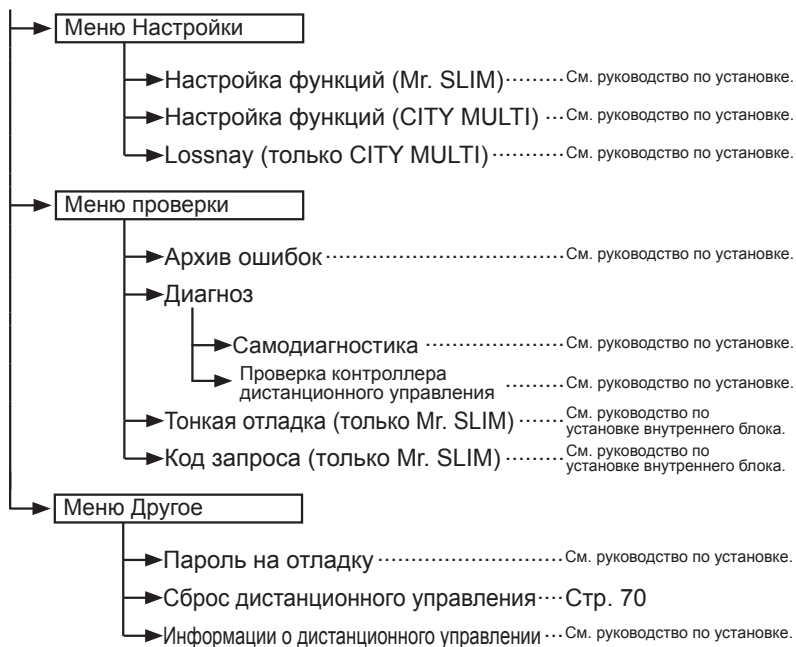

Не все функции доступны на всех моделях внутренних блоков.

Работа контроллера

Таймер



В следующей таблице собраны квадратные значки, используемые в этом руководстве.



Для изменения параметров следует ввести пользовательский пароль администратора или отладки на экране ввода пароля. Нет настроек, которые могут пропустить этот процесс.

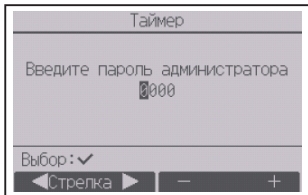

F1 F2 F3 F4

- F1**: нажмите, чтобы переместить курсор влево.
- F2**: нажмите, чтобы переместить курсор вправо.
- F3**: нажмите, чтобы уменьшить значение на 1.
- F4**: нажмите, чтобы увеличить значение на 1.

* Изменения не могут быть сделаны, пока не будет введен верный пароль.



Означает настройки, которые могут быть изменены только, когда блоки находятся в работе.



Означает настройки, которые могут быть изменены только, когда блоки не находятся в работе.



Означает настройки, которые могут быть изменены только, когда блоки работают в режиме «Охлаждение», «Нагрев» или «Авто».



Означает функции, которые не доступны, когда кнопки заблокированы или система управляется централизованно.

Основные операции

ВКЛ/ВЫКЛ питания



Кнопочное управление

ВКЛ

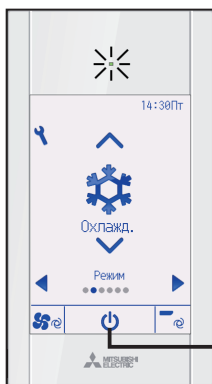

Кнопка **ВКЛ/ВЫКЛ**

Нажмите кнопку **ВКЛ/ВЫКЛ**.

Индикатор ВКЛ/ВЫКЛ будет светиться зеленым цветом, начнется работа.

Когда для параметра «LED-подсветка» установлено значение «Нет», индикатор ВКЛ/ВЫКЛ не будет включаться.

ВЫКЛ



Нажмите повторно кнопку **ВКЛ/ВЫКЛ**.

Индикатор ВКЛ/ВЫКЛ будет выключен, работа будет остановлена.



Кнопочное управление

Режим работы

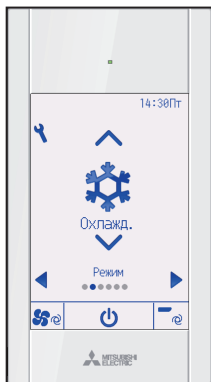

При каждом нажатии кнопки ▼ или ▲ осуществляется циклическая прокрутка следующих режимов работы. Выберите желаемый режим работы.



- Режимы работы, которые недоступны для моделей подключенных внутренних блоков, не будут отображаться на экране.

Мигающие значки режимов

Значок режима будет мигать, когда другие внутренние блоки в аналогичной группе кондиционирования (подключенной к одному наружному блоку) уже работают в другом режиме. В этом случае оставшиеся блоки в этой группе смогут работать только в этом режиме.

<Режим «Авто» (два заданных значения)>

Когда режим работы установлен в режим «Авто» (два заданных значения), могут быть установлены два значения температур (отдельно для охлаждения и для нагрева). В зависимости от температуры помещения, внутренний блок автоматически начнет работать в режиме «Охлаждение» или «Нагрев» и поддерживать температуру комнаты в заданном диапазоне.

На рисунке ниже показан пример операции внутреннего блока, работающего в режиме «Авто» (два заданных значения).

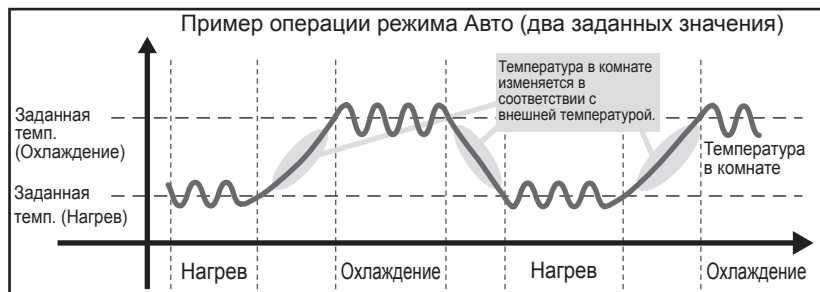



Основные операции

Заданная температура

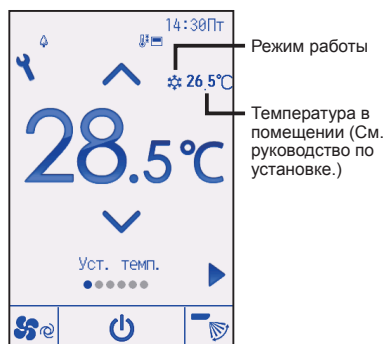
<«Охлаждение», «Сушка», «Нагрев», и «Авто» (одно заданное значение)>



Нажмите кнопку , чтобы уменьшить заданную температуру, а чтобы увеличить — нажмите кнопку .



- Задаваемый температурный диапазон для различных режимов работы см. в таблице на стр. 19.
- Заданный температурный диапазон не может быть установлен для работы вентилятора/вентиляции.
- В зависимости от модели внутреннего блока и настройки режима экрана на контроллере дистанционного управления заданная температура будет отображаться по Цельсию (с шагом в 0,5 или 1 градус) или по Фаренгейту.

<Режим «Авто» (два заданных значения)>

1

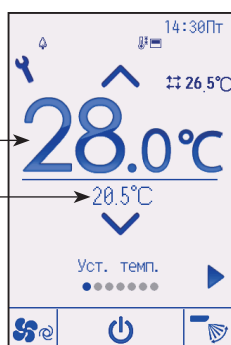
Заданная температура для охлаждения
Заданная температура для нагрева





Отобразятся текущие значения температур. При каждом нажатии кнопки  или  будет переключаться заданная температура для охлаждения и нагрева.

2

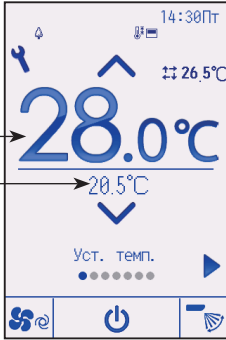
Заданная температура для охлаждения
 Заданная температура для нагрева



Нажмите кнопку , чтобы уменьшить выбранную температуру, а чтобы увеличить — нажмите кнопку .

- Задаваемый температурный диапазон для различных режимов работы см. в таблице ниже.
- Настройки заданной температуры для охлаждения и нагрева в режиме «Авто» (два заданных значения) также используются режимами «Охлаждение»/«Сушка» и «Нагрев».
- Заданные значения температур для охлаждения и нагрева в режиме «Авто» (два заданных значения) должны соответствовать условиям, приведенным ниже:
 - Заданная температура охлаждения выше, чем заданная температура нагрева.
 - Выполняются минимальные требования разницы температуры между заданными температурами охлаждения и нагрева (различается в зависимости от модели подсоединенных внутренних блоков).
 - Если заданные значения температур установлены способом, не удовлетворяющим минимальные требования разницы температуры, оба значения температуры автоматически изменяются в пределах допустимых настроек диапазонов.

Настраиваемый диапазон заданной температуры

Режим работы	Диапазон заданных температур
Охлаждение/сушка	19 ~ 30°C (67 ~ 87°F)
Нагрев	17 ~ 28°C (63 ~ 83°F)
Авто (одно заданное значение)	19 ~ 28°C (67 ~ 83°F)
Авто (два заданных значения)	[Охлаждение] Заданный температурный диапазон для режима «Охлаждение» [Нагрев] Заданный температурный диапазон для режима «Нагрев»
Вентилятора/ вентиляция	Не задается

Настраиваемый диапазон температуры отличается для разных моделей внутренних блоков.

Основные операции

Скорость вентилятора

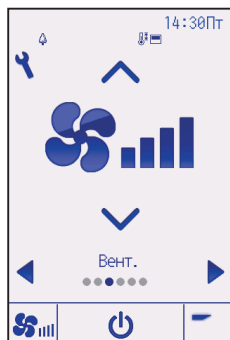

При каждом нажатии кнопки ▼ или ▲ осуществляется циклическая прокрутка следующих значений скорости вентилятора.



• Возможные значения скорости вентилятора зависят от моделей подключенных внутренних блоков.

Настройка угла дефлектора

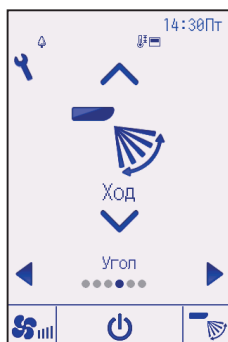

(Снимок экрана для CITY MULTI)

При каждом нажатии кнопки ▼ или ▲ осуществляется циклическая прокрутка следующих настроек угла. Выберите желаемую настройку.

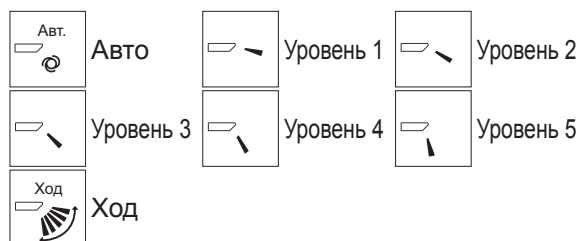

Выберите «Ход» для автоматического перемещения дефлекторов вверх и вниз.

При выборе настройки с «Уровень 1» по «Уровень 5» дефлектор будет оставаться неподвижным под выбранным углом.

- **1h** в левой части значка настройки угла. Этот значок будет отображаться, когда дефлектор установлен в положение «Уровень 2, 3, 4 или 5», а вентилятор работает на низкой скорости в режиме охлаждения или сушки (в зависимости от модели). Значок исчезнет через час, а настройка дефлектора будет автоматически изменена.

Настройка жалюзи

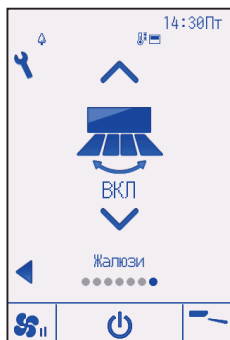

(Снимок экрана для CITY MULTI)

Нажмите кнопку ▼ или ▲, чтобы включить или выключить ход жалюзи.



Настройка вентиляции

Вентиляцию можно настраивать даже тогда, когда блоки находятся в рабочем состоянии.



(Снимок экрана для Mr. SLIM)

При каждом нажатии кнопки ▼ или ▲ осуществляется циклическая прокрутка следующих настроек вентиляции.

* Настройка возможна только, когда подключен блок Lossnay.



• Вентилятор на некоторых моделях внутренних блоков может блокироваться при использовании с некоторыми моделями блоков вентиляции.

Навигация по меню

Список Главного меню

Главное меню	Пункты настройки		Подробные настройки	Стр.
Операция	Максимальная мощность		Используйте, чтобы быстро достичь комфортной температуры в комнате. • Блоки могут работать в режиме максимальной мощности до 30 минут.	25
	Комфорт	Ручная установка угла	Используйте для фиксации каждого угла наклона.	26
Таймер	Таймер	Таймер ВКЛ/ВЫКЛ	Используйте для задания момента включения и выключения. • Время может быть задано с шагом в 5 минут. * Настройте часы.	29
		Автоотключение таймера	Используйте для задания времени автоотключения. • Время может быть задано значением от 30 до 240 минут с шагом в 10 минут.	32
	Таймер на неделю		Используйте для задания момента включения и выключения на неделю. • Для каждого дня может быть задано до 8 моделей работы. • Можно задавать два типа расписаний на неделю. * Настройте часы. * Не действительная, когда задействован таймер включения и выключения. * Шаг в 1°C	34
	Тихий режим		Используйте для задания периодов времени, в которых будет отдаваться преимущество тихой работе наружных блоков при управлении по температуре. Задайте моменты включения и выключения для каждого дня недели. • Выберите желаемый уровень тихого режима из «Норм.», «Средний» или «Тихий». * Настройте часы.	37
	Ночной режим		Используйте для настройки ночного режима. • Выберите «Да» для включения параметра, выберите «Нет» для отключения параметра. Могут быть заданы диапазон температур и моменты запуска и останова. * Настройте часы. * Шаг в 1°C	40
Энергосбережение	Ограничение	Температурного диапазон	Используйте для ограничения диапазона заданных температур. • Для различных режимов работы могут быть заданы разные диапазоны температур. * Шаг в 1°C	43
		Функция блокирования управления	Используйте для блокирования выбранных функций. • Заблокированные функции сработать не смогут.	46
	Энергосбережение	Автовозврат	Используйте, чтобы блоки вернулись к работе по заданной температуре после окончания работы в режиме энергосбережения в заданные период времени. • Время может быть задано значением от 30 до 120 с шагом в 10 минут. * Эта функция будет недействительна, если диапазоны заданных температур будут ограничены. * Шаг в 1°C	49

Главное меню	Пункты настройки		Подробные настройки	Стр.
Энергосбережение	Энергосбережение	Расписание	<p>Задаёт моменты запуска и останова для работы блоков в режиме энергосбережения для каждого дня недели, а также задаёт степень энергосбережения.</p> <ul style="list-style-type: none"> • Для каждого дня может быть задано до 4 моделей работы в режиме энергосбережения. • Время может быть задано с шагом в 5 минут. • Степень энергосбережения может быть задана значением 0% и от 50 до 90% с шагом в 10%. <p>* Настройте часы.</p>	51
Основные настройки	Основные настройки	Часы	Используйте для задания текущего времени.	54
		Летнее время	Устанавливает летнее время.	56
	Настройка дисплея	Основной экран	Используйте для переключения между режимами «Полный» и «Базовый» для экрана Состояния и Основного экрана.	58
		Яркость	Используйте для регулировки уровня яркости экрана.	61
		Выбор языка	Используйте для выбора желаемого языка.	62
		Дизайн	Используется для изменения цвета экрана Состояния и Основного экрана.	64
	Сенсорная панель	Калибровка сенсорной панели	Задаёт настройки калибровки для сенсорной панели.	66
		Чистка сенсорной панели	Сенсорная панель временно не будет реагировать на касания для облегчения ее чистки.	68
Сервисное обслуживание	Сброс дистанционного управления	Используется для сброса контроллера дистанционного управления в состояние, в котором он отправлялся с завода-изготовителя.	70	
	Информации о дистанционном управлении	Используется для отображения модели, версии программного обеспечения и серийного номера контроллера дистанционного управления.	72	
Отладка	Информация о неисправностях	Используйте для проверки информации о неисправностях при возникновении ошибки.	74	
	Информация о фильтре	Используйте для проверки состояния фильтра.	78	

Навигация по меню

Навигация по Главному меню

Кнопочное управление

Доступ ко Главному меню



Нажмите кнопку **[Настройки]** на Основном экране.

Отобразится Главное меню.

Выбор элементов

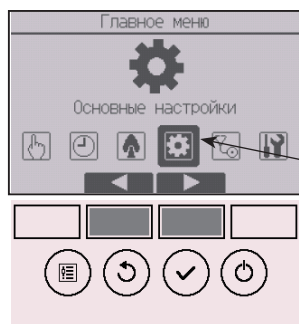

Нажмите **[F2]**, чтобы переместить курсор влево.

Нажмите **[F3]**, чтобы переместить курсор вправо.

Стрелка

Настройки функций

Максимальная мощность



Описание функции

Функция работы в режиме максимальной мощности позволяет блокам работать с отдачей, превышающей нормальную, поэтому воздух в комнате может быть быстро доведен до оптимальной температуры. Работа в этом режиме может продолжаться до 30 минут, блок вернется в режим нормальной работы через 30 минут или ранее, если температура в комнате достигнет значения заданной температуры. Блоки вернуться в режим нормальной работы в случае, если будет изменен режим работы или скорость вентилятора.

Кнопочное управление

1

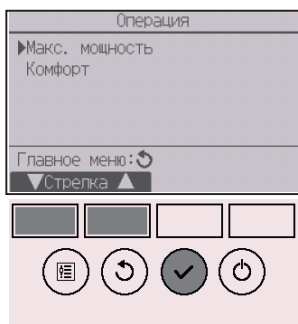

Выберите «Макс. мощность» в меню «Операция» во время работы в режиме «Охлаждение», «Нагрев» или «Автоматическое» и нажмите кнопку **ВЫБОР**.

Функция «Макс. мощность» доступна только для моделей, которые ее поддерживают.

2



Переместите курсор на «Да» с помощью кнопки **F3** или **F4** и нажмите кнопку **ВЫБОР**.

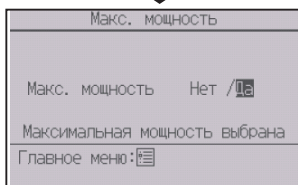

Откроется окно с запросом подтверждения.

Навигация по экранам

- Для возврата в Главное меню..... Кнопка **МЕНЮ**
- Для возврата к предыдущему экрану..... Кнопка **ВОЗВРАТ**

Настройки функций

Ручная установка угла

OFF

Кнопочное управление

1

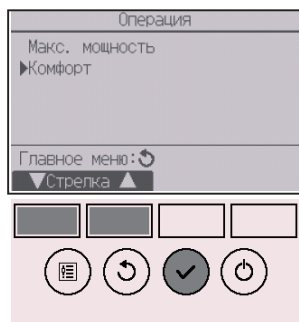

Выберите «Комфорт» в меню «Операция» и нажмите кнопку **ВЫБОР**.

2



С помощью кнопки **F1** или **F2** выберите «Ручная установка угла», а затем нажмите кнопку **ВЫБОР**.

3

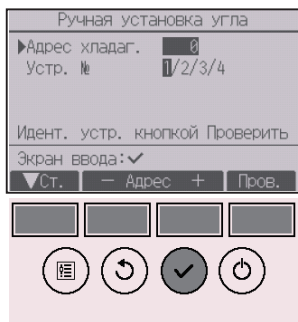

С помощью кнопки **[F1]** переместите курсор на «Адрес хладаг.» или «Устр. №» для выбора. Выберите адрес блока охлаждения и номер блока для блоков, чьи дефлекторы должны быть зафиксированы в неподвижном состоянии, с помощью кнопок **[F2]** или **[F3]**, затем нажмите кнопку **[ВЫБОР]**.

- Адрес блока охлаждения: адрес блока охлаждения
- Устр. №: 1, 2, 3, 4

Нажмите кнопку **[F4]** для подтверждения блока.

Слева показан пример экрана для Mr. SLIM. Для блоков CITY MULTI вместо «Адрес хладаг.» отображается «M-NET адрес», а «Устр. №» не отображается.

4

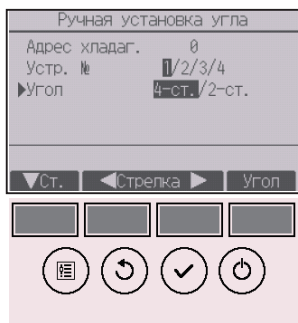

Выберите «Угол» с помощью кнопки **[F1]**.

С помощью кнопки **[F2]** или **[F3]** выберите «4-ст.» или «2-ст.», а затем нажмите кнопку **[F4]**.

Настройки функций

5

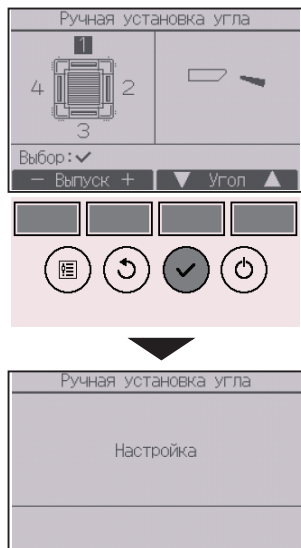

Отобразятся текущие настройки угла дефлектора.

Выберите желаемые выпуски («1», «2», «3», «4» или «1, 2, 3, 4 (все выпуски)») с помощью кнопки [F1] или [F2].

Нажимайте кнопку [F3] или [F4] для прокручивания следующих параметров и выберите желаемую настройку.

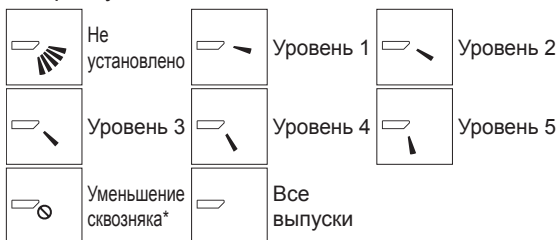

Нажмите кнопку [ВЫБОР], чтобы сохранить настройки. Отобразится экран, показывающий, что передается информация о настройке. Изменения настройки будут выполнены для выбранного выпуска.

После завершения передачи экран автоматически вернется к предыдущему.

Выполните настройку для других выпусков используя аналогичную процедуру.

Если выбраны все выпуски,  будет отображаться, когда блок вступит в работу в следующий раз.

Навигация по экранам

• Для возврата к предыдущему экрану..... Кнопка [ВОЗВРАТ]

* Уменьшение сквозняка

Режим [Уменьшение сквозняка] ставит лопасти в более горизонтальное положение, чем в режиме Уровень 1, чтобы воздушный поток не был направлен на людей.

Эта функция задается только для одного выхода.

Эта функция не задается для моделей с двумя или тремя выходами.

В режиме Уменьшение сквозняка воздушный поток может вызвать обесцвечивание потолка.

Таймер (Таймер ВКЛ/ВЫКЛ)



Кнопочное управление

1



Выберите «Таймер» из Главного меню (см. стр. 24) и нажмите кнопку **ВЫБОР**.

Функция «Таймер ВКЛ/ВЫКЛ» не будет работать в следующих случаях:

когда функция «Таймер ВКЛ/ВЫКЛ» отключена, при возникновении ошибки, во время проверки (в сервисном меню), во время тестового запуска, во время диагностики дистанционного контроллера, когда не заданы часы, во время настройки функций, при централизованном управлении системой (когда операция «Вкл/Выкл» или операция «Таймер» с локального контроллера дистанционного управления запрещены).

2

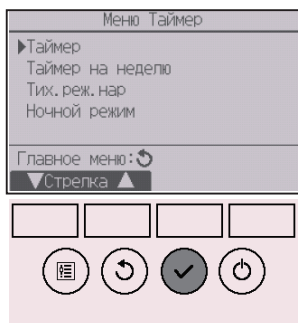

Переместите курсор на «Таймер» и нажмите кнопку **ВЫБОР**.

3

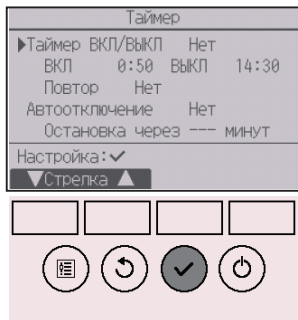

Отобразятся текущие настройки.

Переместите курсор на «Таймер ВКЛ/ВЫКЛ» и нажмите кнопку **ВЫБОР**.

Настройки функций

4



Отобразится окно для установки таймера.

Выберите нужный элемент с помощью кнопок **F1** или **F2** над «Таймер ВКЛ/ВЫКЛ», «ВКЛ», «ВЫКЛ» или «Повтор».

5



Измените настройку с помощью кнопки **F3** или **F4**.

- Таймер ВКЛ/ВЫКЛ: Нет (отключено) / Да (включено)
- ВКЛ: Время начала работы
(задается с шагом в 5 минут)
 - * Для быстрого увеличения чисел нажмите и удерживайте кнопку.
- ВЫКЛ: Время остановки работы
(задается с шагом в 5 минут)
 - * Для быстрого увеличения чисел нажмите и удерживайте кнопку.
- Повтор: Нет (однократно) / Да (повтор)

6



Нажмите кнопку **ВЫБОР**, чтобы сохранить настройки.

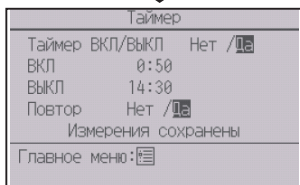



Откроется окно с запросом подтверждения.

Навигация по экранам

- Для возврата в Главное меню..... Кнопка **МЕНЮ**
- Для возврата к предыдущему экрану..... Кнопка **ВОЗВРАТ**



 будет отображаться на экране Состояния и на Основном экране в режиме «Полный», когда включена функция «Таймер ВКЛ/ВЫКЛ».

 появляется, когда таймер отключен централизованной системой управления.

Настройки функций

Таймер (Автоотключение таймера)



Кнопочное управление

1



Открытие окна настройки таймера.
(См. стр. 29.)

Выберите «Автоотключение» и нажмите кнопку **ВЫБОР**.

Функция «Автоотключение таймера» не будет работать в следующих случаях:
когда функция «Автоотключение таймера» отключена, при возникновении ошибки, во время проверки (в сервисном меню), во время тестового запуска, во время диагностики контроллера дистанционного управления, во время настройки функций, при централизованном управлении системой (когда операция «Вкл/Вык» или операция «Таймер» с локального контроллера запрещены).

2

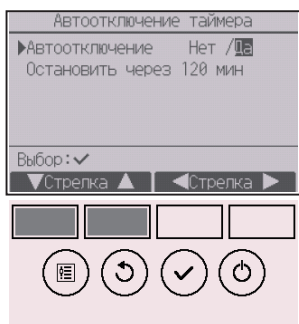

Отобразятся текущие настройки.

Переместите курсор на «Автоотключение» или «Остановка через --- минут» с помощью кнопки **F1** или **F2**.

3

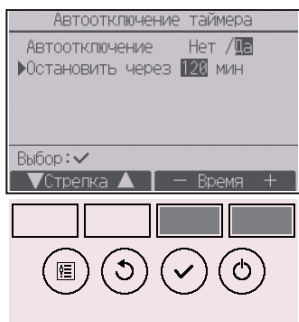

Измените настройку с помощью кнопки **F3** или **F4**.

- Автоотключение: Нет (отключено) / Да (включено)
- Остановка через --- минут: настройка таймера (допустимый диапазон составляет от 30 до 240 минут с шагом 10 минут.)

4

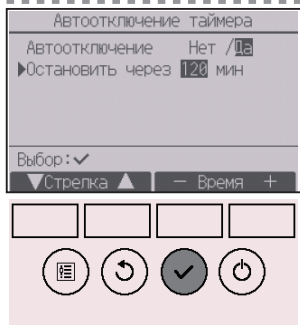

Нажмите кнопку **ВЫБОР**, чтобы сохранить настройки.

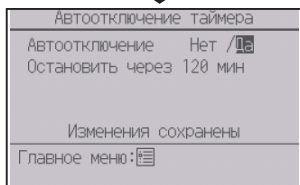



Откроется окно с запросом подтверждения.

Навигация по экранам

- Для возврата в Главное меню..... Кнопка **МЕНЮ**
- Для возврата к предыдущему экрану..... Кнопка **ВОЗВРАТ**



 будет отображаться на экране Состояния и на Основном экране в режиме «Полный», когда включена функция «Автоотключение таймера».

 появляется, когда таймер отключен централизованной системой управления.

Настройки функций

Таймер на неделю



Кнопочное управление

1

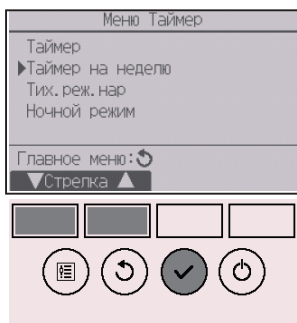

Выберите «Таймер на неделю» в меню «Таймер» и нажмите кнопку **[ВЫБОР]**.

Функция «Таймер на неделю» не будет работать в следующих случаях:

когда функция «Таймер ВКЛ/ВЫКЛ» отключена, когда функция «Таймер на неделю» отключена, при возникновении ошибки, во время проверки (в сервисном меню), во время тестового запуска, во время диагностики контроллера дистанционного управления, когда не заданы часы, во время настройки функций, при централизованном управлении системой (когда операция «Вкл/Вык», настройка температуры или операция «Таймер» с локального контроллера дистанционного управления запрещены).

2



Отобразятся текущие настройки.

Нажмите кнопку **[F1]** или **[F2]**, чтобы увидеть настройки для каждого дня недели.

Нажмите кнопку **[F3]**, чтобы увидеть модели с 5 по 8. Нажмите кнопку **[F4]**, чтобы отобразить состояние Настройки 2.

Нажмите кнопку **[ВЫБОР]**, чтобы перейти на экран настройки.

3

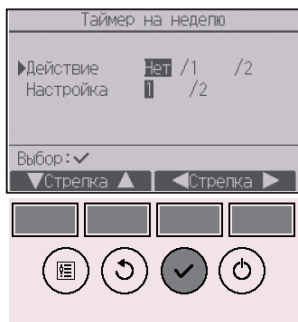

Появится экран настроек таймера на неделю.

С помощью кнопки **[F3]** или **[F4]** выберите для настройки «Действие» значение «1», чтобы включить настройку таймера 1, или выберите «2», чтобы включить настройку таймера 2. После этого нажмите кнопку **[ВЫБОР]**.

Для проверки содержимого настройки таймера 1 или 2 переместите курсор на «Настройка» с помощью кнопки **[F1]** или **[F2]**, а затем выберите «1» или «2» с помощью кнопки **[F3]** или **[F4]**.

4

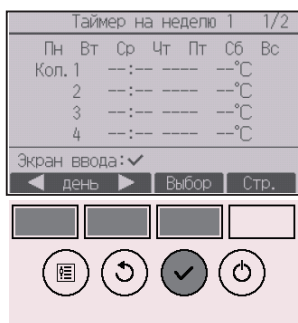

Будет открыто окно настройки таймера на неделю и отображены текущие настройки.

Для каждого дня может быть задано до 8 моделей работы.

С помощью кнопки **[F1]** или **[F2]** переместите курсор на требуемый день недели и нажмите кнопку **[F3]** для его выбора. (Можно выбирать несколько дней.)

Нажмите кнопку **[ВЫБОР]**.

Настройки функций

5

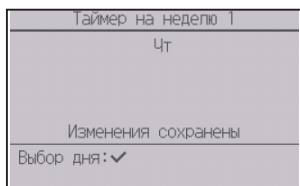

Отобразится окно настройки модели работы.

Нажмите кнопку **[F1]**, чтобы переместить курсор на номер нужной модели.

С помощью кнопки **[F2]** переместите курсор на время, ВКЛ/ВЫКЛ или температуру.

Измените настройки с помощью кнопки **[F3]** или **[F4]**.

- Время: задается с шагом в 5 минут
- * Для быстрого увеличения чисел нажмите и удерживайте кнопку.
- ВКЛ/ВЫКЛ/Авт.: возможность выбора настроек зависит от модели подключенного внутреннего блока. (Когда выполнен шаблон «Авто», система будет работать в режиме «Авто» (два заданных значения).)
- Температура: задаваемый диапазон температур меняется в зависимости от подключенных внутренних блоков. (Шаг в 1°C)

Когда выбран режим «Авто» (два заданных значения), могут быть установлены два значения заданной температуры. Если основная операция выполнена во время режима «Авто» (два заданных значения) с настройкой одной заданной температуры, эта настройка будет использована как настройка температуры охлаждения в режиме «Охлаждение».

Нажмите кнопку **[ВЫБОР]**, чтобы сохранить настройки. Откроется окно с запросом подтверждения.

Навигация по экранам

- Для возврата на экран изменения настройки и выбора дня недели Кнопка **[ВЫБОР]**
- Для возврата в Главное меню Кнопка **[МЕНЮ]**
- Для возврата к предыдущему экрану Кнопка **[ВОЗВРАТ]**



[7] будет отображено на экране Состояния и Основном экране в режиме отображения «Полный», если заданы настройки таймера на неделю для текущего дня.

Значок не появится, пока таймер ВКЛ/ВЫКЛ включен или система находится под централизованным управлением (операция «Таймер» с контроллера дистанционного управления запрещена).

Описание функции

Эта функция позволяет пользователю задавать периоды времени, в которых будет отдаваться преимущество тихой работе наружных блоков при управлении по температуре. Установите моменты запуска и останова работы в тихом режиме для каждого дня недели. Выберите желаемый уровень тихого режима из «Средний» или «Тихий».

Кнопочное управление

1



Выберите «Тих.реж.нар» в меню «Таймер» и нажмите кнопку **ВЫБОР**.

Функция «Тих.реж.нар» доступна только для моделей, которые ее поддерживают.

2



Отобразятся текущие настройки.

Нажмите кнопку **F1** или **F2**, чтобы увидеть настройки для каждого дня недели.

Нажмите кнопку **ВЫБОР**, чтобы перейти на экран настройки.

Настройки функций

3

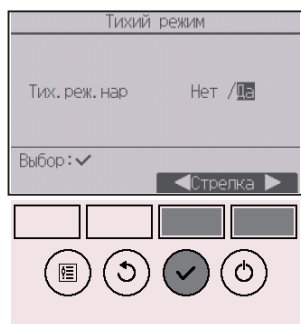

Отобразится окно для включения (Да) или отключения (Нет) тихого режима.

Чтобы включить эту функцию, переместите курсор на «Да» с помощью кнопки **F3** или **F4** и нажмите кнопку **ВЫБОР**.

4



Будет отображен экран настроек тихого режима.

Для задания или изменения этой настройки с помощью кнопки **F1** или **F2** переместите курсор на требуемый день недели и нажмите кнопку **F3** для его выбора. (Можно выбирать несколько дней.)

Нажмите кнопку **ВЫБОР**.

5

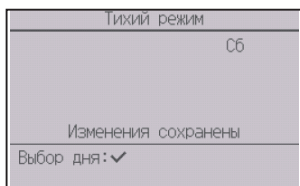
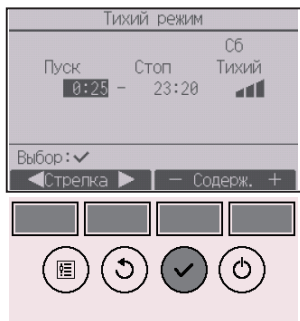

Отобразится экран настройки.

С помощью кнопки [F1] и [F2] переместите курсор на требуемый элемент над значением времени запуска, времени останова или уровня тишины.

Измените настройки с помощью кнопки [F3] или [F4].

- Время запуска и останова: задается с шагом в 5 минут
* Для быстрого увеличения чисел нажмите и удерживайте кнопку.
- Уровень тихого режима: «Нормальный», «Средний» или «Тихий»



Нажмите кнопку [ВЫБОР], чтобы сохранить настройки. Откроется окно с запросом подтверждения.

Навигация по экранам

- Для возврата на экран изменения настройки и выбора дня недели Кнопка [ВЫБОР]
- Для возврата в Главное меню Кнопка [МЕНЮ]
- Для возврата к предыдущему экрану Кнопка [ВОЗВРАТ]



 будет отображаться на экране Состояния и на Основном экране в режиме «Полный» во время тихого режима.

Настройки функций

Ночной режим



Описание функции

Функция управляет началом нагрева, когда группа управления объектом остановлена, а комнатная температура упала ниже заданного нижнего предела температуры. Кроме того, эта функция запускает охлаждение, когда группа управления объектом остановлена, а комнатная температура превысила заданный верхний предел температуры.

Функция ночного режима не доступна, если управление и задание температуры выполняются с контроллера дистанционного управления.

Если температура в помещении измеряется датчиком температуры воздуха на входе кондиционера, может не быть получено точное значение температуры при отключенном кондиционере или в условиях спертого воздуха. В этом случае переключите датчик на удаленный контроллер (PAC-SE40TSA/PAC-SE41TS-E) или на датчик удаленного контроллера.

Кнопочное управление

1



Выберите «Ночной режим» в меню «Таймер» и нажмите кнопку **ВЫБОР**.

2



Отобразятся текущие настройки.

Нажмите кнопку **ВЫБОР**, чтобы перейти на экран настройки.

3

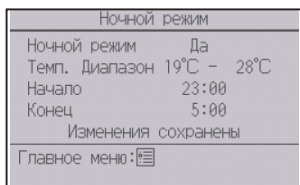

Переместите курсор на требуемый элемент с помощью кнопки **[F1]** или **[F2]** над «Ночной режим» «Нет» (выключить) или «Да» (включить), «Температурного диапазон», временем начала и временем окончания.

Измените настройки с помощью кнопки **[F3]** или **[F4]**.

- Темп. Диапазон: нижняя предельная температура (для управления нагревом) и верхняя предельная температура (для управления охлаждением) могут быть заданы. Разница температур между нижним и верхним пределами должна составлять 4°C (8°F) или больше. Задаваемый диапазон температур меняется в зависимости от подключенных внутренних блоков.
* Шаг в 1°C
- Время запуска и останова: задается с шагом в 5 минут
- * Для быстрого увеличения чисел нажмите и удерживайте кнопку.

Нажмите кнопку **[ВЫБОР]**, чтобы сохранить настройки.

Откроется окно с запросом подтверждения.

Навигация по экранам

- Для возврата в Главное меню..... Кнопка **[МЕНЮ]**
- Для возврата к предыдущему экрану..... Кнопка **[ВОЗВРАТ]**

Настройки функций



⚙️ будет отображаться на экране Состояния и на Основном экране в режиме «Полный», когда включена функция «Ночной режим».

⌚ появляется, когда таймер отключен централизованной системой управления.

Функция «Ночной режим» не будет работать в следующих случаях:

когда блок работает, когда функция «Ночной режим» отключена, при возникновении ошибки, во время проверки (в сервисном меню), во время тестового запуска, во время диагностики контроллера дистанционного управления, когда не заданы часы, во время настройки функций, при централизованном управлении системой (когда операция «Вкл/Вык», настройка температуры или операция «Таймер» с локального контроллера дистанционного управления запрещены).

Задание ограничения диапазона температур

Кнопочное управление

1

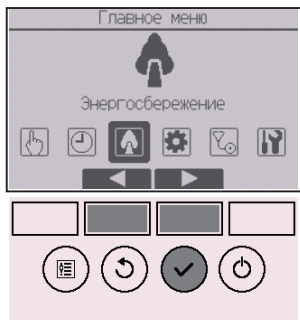

Выберите «Энергосбережение» из Главное меню (см. стр. 24) и нажмите кнопку **ВЫБОР**.

2



Переместите курсор на «Ограничение» с помощью кнопки **F1** или **F2** и нажмите кнопку **ВЫБОР**.

Настройки функций

3

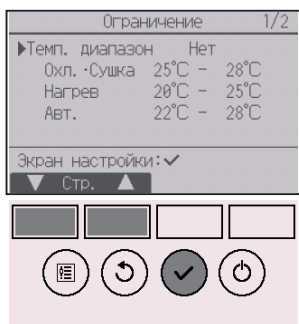

Отобразятся текущие настройки.

Переместите курсор на «Темп. Диапазон» с помощью кнопки **F1** или **F2** и нажмите кнопку **ВЫБОР**.

4



Отобразится окно для задания температурного диапазона.

Переместите курсор к нужному элементу с помощью кнопки **F1** над «Темп. Диапазон», «Охл. ·Сушка», «Нагрев» или «Авт.».

5

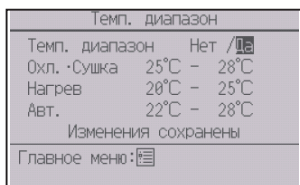

Измените настройки с помощью кнопки [F3] или [F4].

- Темп. Диапазон: Нет (неограничен) или Да (ограничен)
- Охл. - Сушка: верхняя и нижняя предельная температура (шаг в 1°C)
- Нагрев: верхняя и нижняя предельная температура (шаг в 1°C)
- Авт.: верхняя и нижняя предельная температура (шаг в 1°C)

Диапазоны задаваемых температур

Режим	Нижний предел	Верхний предел
Охлаждение - Сушка *1*3	19 ~ 30°C (67 ~ 87°F)	30 ~ 19°C (87 ~ 67°F)
Нагрев *2*3	17 ~ 28°C (63 ~ 83°F)	28 ~ 17°C (83 ~ 63°F)
Авто *4	19 ~ 28°C (67 ~ 83°F)	28 ~ 19°C (83 ~ 67°F)

* Задаваемый диапазон меняется в зависимости от подключенного блока.

*1 Температурные диапазоны для режимов «Охлаждение», «Сушка» и «Авто» (два заданных значения) могут быть установлены.

*2 Для режимов «Нагрев» и «Авто» (два заданных значения) могут быть установлены температурные диапазоны.

*3 Температурные диапазоны для режимов «Нагрев», «Охлаждение» и «Сушка» должны соответствовать условиям, приведенным ниже:

- Верхний предел для охлаждения – верхний предел для нагрева \geq минимальная разница температур (в зависимости от модели внутреннего блока)
- Нижний предел для охлаждения – нижний предел для нагрева \geq минимальная разница температур (в зависимости от модели внутреннего блока)

*4 Для режима «Авто» (одно заданное значение) может быть установлен температурный диапазон.

Нажмите кнопку [ВЫБОР], чтобы сохранить настройки.

Откроется окно с запросом подтверждения.

Навигация по экранам

- Для возврата в Главное меню..... Кнопка [МЕНЮ]
- Для возврата к предыдущему экрану..... Кнопка [ВОЗВРАТ]

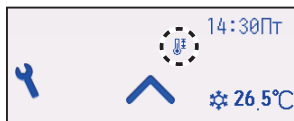

 будет отображаться на экране Состояния и на Основном экране в режиме «Полный», если температурный диапазон ограничен.

Настройки функций

Ограничение



Функция блокирования управления

Кнопочное управление

Чтобы включить функцию блокирования управления, задайте «Да» для «Управл. блокир.».

1

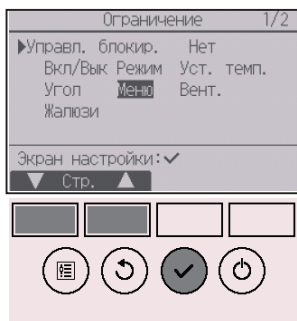

Открытие окна настройки ограничений. (См. стр. 43.)

Переместите курсор на «Управл. блокир.» и нажмите кнопку **ВЫБОР**.

2

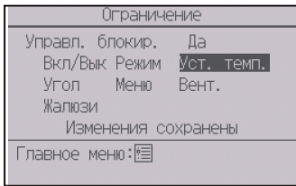

Отобразится окно, в котором можно настроить функцию блокировки управления.

Переместите курсор на нужный элемент с помощью кнопки [F1] или [F2] над «Управл. блокир.», «Расположение» «Вкл/Вык», «Режим», «Уст. темп.», «Меню», «Вент.», «Жалюзи» или «Угол».

Измените настройки с помощью кнопки [F3] или [F4].

- Управл. блокир.: Нет (отключено) / Да (включено)
- Расположение: «Индив.» или «Отель»
- Вкл/Выкл: включение и выключение работы
- Режим: настройка режима работы
- Уст. темп.: настройка заданной температуры
- Угол: настройка угла дефлектора
- Меню: настройка меню
- Вент.: установка скорости вентилятора
- Жалюзи: настройка жалюзи

Если для параметра «Расположение» выбрано значение «Отель», следующие операции автоматически блокируются: «Режим», «Угол», «Меню» и «Жалюзи».

Нажмите кнопку [ВЫБОР], чтобы сохранить настройки.

Откроется окно с запросом подтверждения.

Навигация по экранам

- Для возврата в Главное меню..... Кнопка [МЕНЮ]
- Для возврата к предыдущему экрану..... Кнопка [ВОЗВРАТ]

Настройки функций



 будет отображаться на экране Состояния и на Основном экране в режиме «Полный», когда включена настройка функции блокирования управления.

Подсказка для работы, соответствующая блокированной функции, будет скрыта.

Чтобы отобразить главное меню во время блокировки настройки меню, нажмите и удерживайте кнопку **Настройки** не менее десяти секунд. Введите пароль администратора на экране ввода пароля.

Автоматический возврат к заданной температуре

Если включена функция Автовозврат, при выполнении с этого контроллера дистанционного управления операции смены режима работы или включения/выключения заданная температура автоматически возвращается к требуемой температуре независимо от заданного времени.

Кнопочное управление

1



Выберите «Энергосбережение» в меню «Энергосбережение» и нажмите кнопку **ВЫБОР**.

2

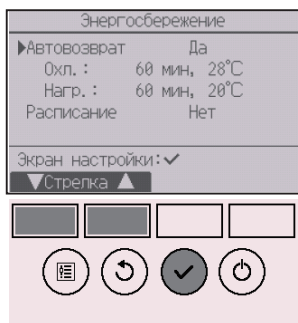

Отобразятся текущие настройки.

Переместите курсор на «Автовозврат» с помощью кнопки **F1** или **F2** и нажмите кнопку **ВЫБОР**.

Настройки функций

3



Отобразится экран настроек для функции автовозврата к заданной температуре.

Переместите курсор к нужному элементу с помощью кнопки [F1] или [F2] над «Автовозврат», «Охл.» или «Нагр.».

4



Измените настройки с помощью кнопки [F3] или [F4].

- Автовозврат: Нет (отключено) / Да (включено)
- Охл.: диапазон настройка таймера составляет от 30 до 120 минут с шагом 10 минут. Диапазон задания температуры составляет от 19 до 30°C (67 ~ 87°F) (шаг в 1°C).
- Нагр.: диапазон настройка таймера составляет от 30 до 120 минут с шагом 10 минут. Диапазон задания температуры составляет от 17 до 28°C (63 ~ 83°F) (шаг в 1°C).

Нажмите кнопку **ВЫБОР**, чтобы сохранить настройки. «Охл.» включает в себя режимы «Сушка» и «Авт. охлажд.», а «Нагр.» включает в себя режим «Авт. нагрев». Отобразится окно для задания выбранного элемента.

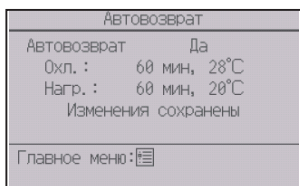

Навигация по экранам

- Для возврата в Главное меню..... Кнопка **МЕНЮ**
- Для возврата к предыдущему экрану..... Кнопка **ВОЗВРАТ**

Настройки «Таймера» или предварительно заданной температуры не будут действовать, когда включена функция ограничения темп. диапазона, а также при централизованном управлении системой (когда установка темп. диапазона с локального контроллера запрещена). При централизованном управлении системой (когда операция «Таймер» с локального контроллера дистанционного управления запрещена) только настройка «Таймера» будет недоступна.

Настройка расписания работы в режиме энергосбережения

Кнопочное управление

1

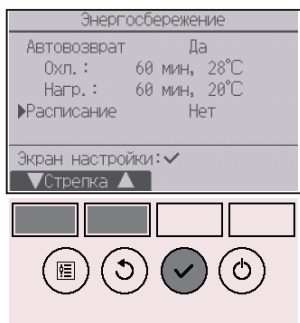

Открытие окна настройки «Энергосбережение». (См. стр. 49.)

Переместите курсор на «Расписание» и нажмите кнопку **[ВЫБОР]**.

2

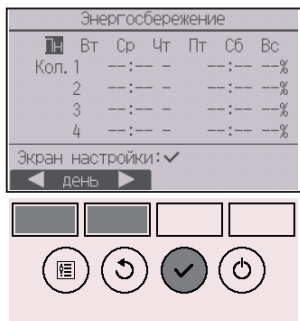

Отобразится окно для просмотра расписания.

Нажмите кнопку **[F1]** или **[F2]**, чтобы увидеть настройки для каждого дня недели.

Нажмите кнопку **[ВЫБОР]**, чтобы перейти на экран настройки.

3



Отобразится окно для включения (Да) или отключения (Нет) расписания работы в режиме энергосбережения.

Выберите «Нет» или «Да» с помощью кнопок **[F3]** или **[F4]**.

Нажмите кнопку **[ВЫБОР]**, чтобы перейти на экран изменения настройки и выбора дня недели.

Настройки функций

4



Отобразится экран изменения настройки и выбора дня недели.

Для каждого дня может быть задано до 4 моделей работы.

С помощью кнопки **[F1]** или **[F2]** переместите курсор на требуемый день недели и нажмите кнопку **[F3]** для его выбора. (Можно выбирать несколько дней.)

Нажмите кнопку **[ВЫБОР]**, чтобы перейти на экран настройки шаблона.

5



Отобразится экран настройки модели.

Нажмите кнопку **[F1]**, чтобы переместить курсор на номер нужной модели.

Переместите курсор на нужный элемент с помощью кнопки **[F2]** над временем начала, временем окончания и степенью энергосбережения (расположенных в этом порядке слева).

Измените настройки с помощью кнопки **[F3]** или **[F4]**.

- Время запуска и останова: задается с шагом в 5 минут
- * Для быстрого увеличения чисел нажмите и удерживайте кнопку.
- Степень энергосбережения: диапазон значений настройки — 0% и от 50 до 90% с шагом 10%.

Нажмите кнопку **[ВЫБОР]**, чтобы сохранить настройки.

Откроется окно с запросом подтверждения.

Чем меньше значение, тем больше эффект энергосбережения.

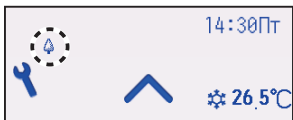

 отобразится на экране Состояния и на Основном экране в режиме «Полный», когда блок работает в режиме энергосбережения.

Навигация по экранам

- Для возврата на экран изменения настройки и выбора дня недели Кнопка **ВЫБОР**
- Для возврата в Главное меню Кнопка **МЕНЮ**
- Для возврата к предыдущему экрану Кнопка **ВОЗВРАТ**

Настройки функций

Часы



Кнопочное управление

1



Выберите «Основные настройки» из Главного меню (см. стр. 24) и нажмите кнопку **ВЫБОР**.

Предварительная настройка часов необходима для выполнения следующих настроек.

- Таймер ВКЛ/ВЫКЛ
- Таймер на неделю
- Тихий режим
- Энергосбережение
- Ночной режим

Если система не оснащена системными контроллерами, время не будет корректироваться автоматически.

В этом случае необходимо периодически корректировать время.

2

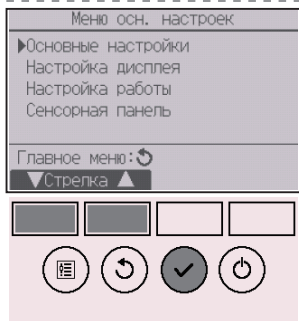

Переместите курсор на «Основные настройки» с помощью кнопки **F1** или **F2** и нажмите кнопку **ВЫБОР**.

3

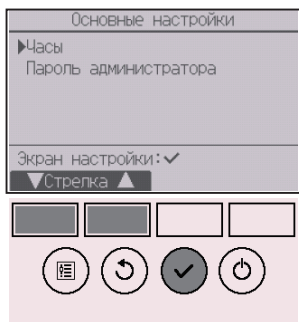

Выберите «Часы» с помощью кнопки **F1** или **F2**, а затем нажмите кнопку **ВЫБОР**.

4

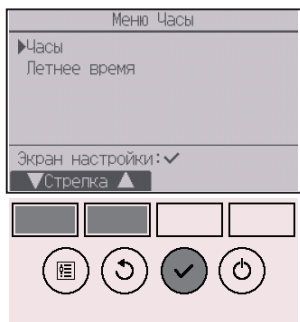

Переместите курсор на «Часы» с помощью кнопки [F1] или [F2] и нажмите кнопку [ВЫБОР].

5



Переместите курсор на желаемый элемент с помощью кнопок [F1] или [F2] над значением года, месяца, даты, часа или минуты.

Увеличьте или уменьшите значение для выбранного элемента с помощью кнопок [F3] или [F4], затем нажмите кнопку [ВЫБОР].

Откроется окно с запросом подтверждения.

Навигация по экранам

- Для возврата в Главное меню..... Кнопка [МЕНЮ]
- Для возврата к предыдущему экрану..... Кнопка [ВОЗВРАТ]

Настройки функций

Летнее время



Описание функции

Можно установить время начала-окончания действия летнего времени. Функция летнего времени активируется в соответствии с заданными параметрами.

- Если система оснащена системным контроллером, выключите эту настройку, чтобы обеспечить правильное значение времени.
- При начале и окончании действия летнего времени таймер может включиться дважды или не включиться совсем.
- Эта функция работает только в том случае, если выполнены настройки часов.

Кнопочное управление

1

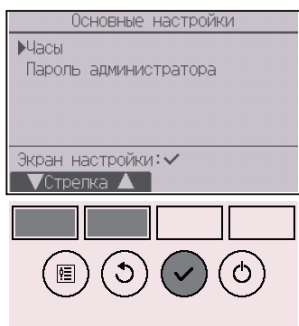

Выберите «Часы» в меню «Основные настройки» и нажмите кнопку **ВЫБОР**.

2

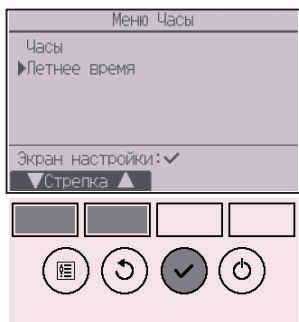

Переместите курсор на «Летнее время» с помощью кнопки **F1** или **F2** и нажмите кнопку **ВЫБОР**.

3

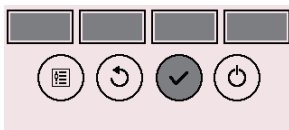
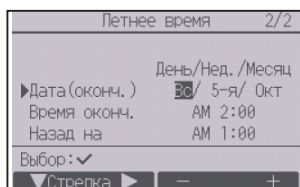
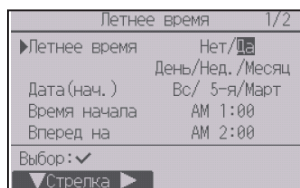

С помощью кнопки **[F1]** перемещайте стрелку на следующие элементы меню, чтобы выполнить настройки.

- **Летнее время**
Выберите «Нет» (отключить) или «Да» (включить) кнопкой **[F2]**. По умолчанию выбрано «Нет».
 - **Дата(нач.)*1**
Кнопкой **[F3]** или **[F4]** выберите день недели, номер недели и месяц. По умолчанию установлено «Вс/5-я/Март».
 - **Время начала**
Выберите время начала действия летнего времени кнопкой **[F3]** или **[F4]**.
 - **Вперед на**
Кнопкой **[F3]** или **[F4]** выберите время перевода часов вперед при установке времени начала в предыдущем шаге.
 - **Дата(оконч.)*1 (стр. 2)**
Кнопкой **[F3]** или **[F4]** выберите день недели, номер недели и месяц. По умолчанию установлено «Вс/5-я/Окт».
 - **Время оконч. (стр. 2)**
Выберите время окончания действия летнего времени кнопкой **[F3]** или **[F4]**.
 - **Назад на (стр. 2)**
Кнопкой **[F3]** или **[F4]** выберите время перевода часов назад при установке времени окончания в предыдущем шаге.
- *1 Если в качестве номера недели выбрано «5-я», а 5-й недели в выбранном месяце не существует, необходимо выбрать настройку «4-я».

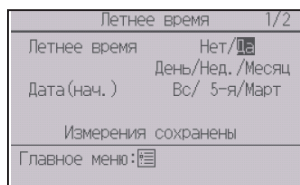

Нажмите кнопку **[ВЫБОР]**, чтобы сохранить настройки. Откроется окно с запросом подтверждения.

Навигация по экранам

- Для возврата в Главное меню..... Кнопка **[МЕНЮ]**
- Для возврата к предыдущему экрану..... Кнопка **[ВОЗВРАТ]**

Настройки функций

Основной экран



Кнопочное управление

1

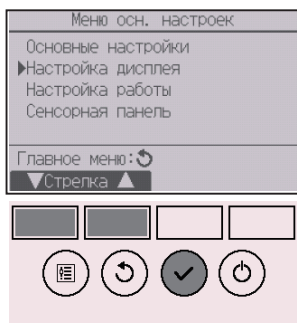

Выберите «Настройка дисплея» в Меню Основные настроек и нажмите кнопку **[ВЫБОР]**.

2

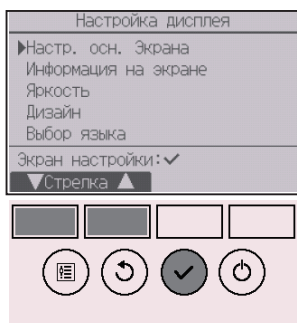

Переместите курсор на «Настр. осн. экрана» с помощью кнопки **[F1]** или **[F2]** и нажмите кнопку **[ВЫБОР]**.

3



Выберите «Полный» или «Базовый» (см. стр. 10) с помощью кнопки **[F3]** или **[F4]**, а затем нажмите кнопку **[ВЫБОР]**.

Откроется окно с запросом подтверждения.

Навигация по экранам

- Для возврата в Главное меню..... Кнопка **[МЕНЮ]**
- Для возврата к предыдущему экрану..... Кнопка **[ВОЗВРАТ]**

Кнопочное управление

1

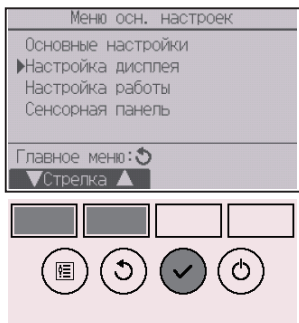

Выберите «Настройка дисплея» в Меню Основные настроек и нажмите кнопку **ВЫБОР**.

2

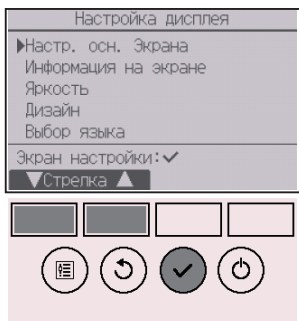

Переместите курсор на «Настр. осн. экрана» с помощью кнопки **F1** или **F2** и нажмите кнопку **ВЫБОР**.

3



Выберите «Описание значка» с помощью кнопки **F1** или **F2**, затем выберите желаемую настройку «Да» или «Нет» с помощью кнопки **F3** или **F4**, а затем нажмите кнопку **ВЫБОР**. По умолчанию выбрано «Да».

Навигация по экранам

- Для возврата в Главное меню..... Кнопка **МЕНЮ**
- Для возврата к предыдущему экрану..... Кнопка **ВОЗВРАТ**

Настройки функций

4



Если выбрано значение «Да», рядом с пунктом настройки будет отображаться описание значка, как показано слева.

Кнопочное управление

1

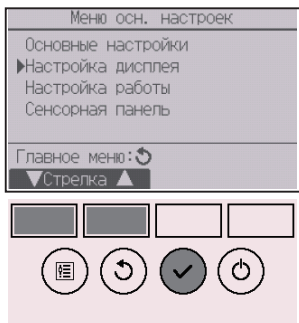

Выберите «Настройка дисплея» в Меню Основные настроек и нажмите кнопку **[ВЫБОР]**.

2

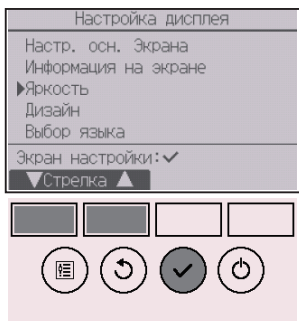

Переместите курсор на «Яркость» с помощью кнопки **[F1]** или **[F2]** и нажмите кнопку **[ВЫБОР]**.

3

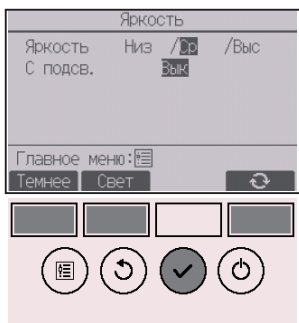

Отрегулируйте яркость с помощью кнопки **[F1]** или **[F2]**. Чтобы выбрать значение «ВКЛ» или «ВЫКЛ» для настройки «С подсвет.», воспользуйтесь кнопкой **[F4]**.

Если выбрано значение «ВКЛ», подсветка будет оставаться включенной и затемненной даже по истечении указанного времени.

Навигация по экранам

- Для возврата в Главное меню..... Кнопка **[МЕНЮ]**
- Для возврата к предыдущему экрану..... Кнопка **[ВОЗВРАТ]**

Настройки функций

Выбор языка



Описание функции

Может быть задан желаемый язык. Могут быть заданы следующие языки: английский, французский, немецкий, испанский, итальянский, португальский, шведский, русский, греческий, турецкий, нидерландский, чешский, венгерский и польский.

Кнопочное управление

1

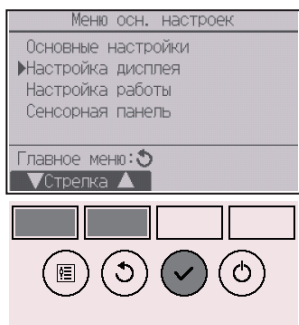

Выберите «Настройка дисплея» в Меню Основные настроек и нажмите кнопку **ВЫБОР**.

2

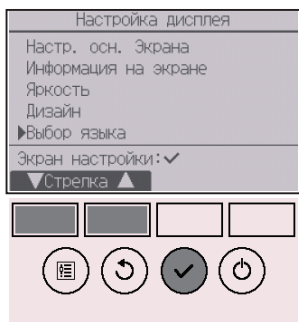

Переместите курсор на «Выбор языка» с помощью кнопки **F1** или **F2** и нажмите кнопку **ВЫБОР**.

3



Переместите курсор на желаемый язык с помощью кнопок **F1**—**F4** и нажмите кнопку **ВЫБОР** для сохранения настройки.

При первом включении питания появится экран «Выбор языка». Выберите желаемый язык. Запуск системы невозможен без выбора языка.



Отобразится экран, показывающий, что настройка была сохранена.



Навигация по экранам

- Для возврата в Главное меню..... Кнопка **МЕНЮ**
- Для возврата к предыдущему экрану..... Кнопка **ВОЗВРАТ**

Настройки функций

Дизайн



Кнопочное управление

1

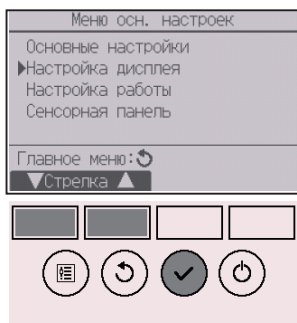

Выберите «Настройка дисплея» в Меню Основные настроек и нажмите кнопку **[ВЫБОР]**.

2

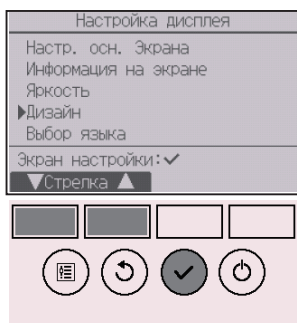

Переместите курсор на «Дизайн» с помощью кнопки **[F1]** или **[F2]** и нажмите кнопку **[ВЫБОР]**.

3

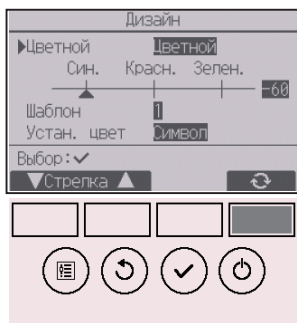

Выберите «Цветной» с помощью кнопки **[F4]**.

- Цветной: позволяет выбрать цвет изображения. (См. следующую страницу.)
- Белый: черно-белое изображение (с белым цветом в качестве основного).
- Черный: черно-белое изображение (с черным цветом в качестве основного).

При выборе опции «Белый» или «Черный» нажмите кнопку **[ВЫБОР]**. Если выбран вариант «Цветной», выберите желаемый цвет в соответствии с указаниями, приведенными на следующей странице.

4

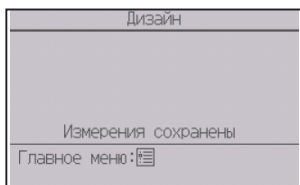

Выберите следующий пункт с помощью кнопки **[F1]** или **[F2]** и задайте желаемый цвет отображения для каждого элемента.

- Оттенок цвета: задайте оттенок цвета с помощью кнопки **[F3]** или **[F4]**. (Можно указывать значения в диапазоне от -90 до 89.)
- Шаблон: задайте оттенок цвет с помощью кнопки **[F4]**.
- Устан. цвет: с помощью кнопки **[F4]** выберите «Символ» или «Фон» в качестве цели для применения цвета.

Образец цвета под кнопками функций будет изменяться в соответствии с настройкой.

Задайте нужный цвет и нажмите кнопку **[ВЫБОР]**.

Навигация по экранам

- Для возврата в Главное меню..... Кнопка **[МЕНЮ]**
- Для возврата к предыдущему экрану..... Кнопка **[ВОЗВРАТ]**

Настройки функций

Калибровка сенсорной панели



Кнопочное управление

1

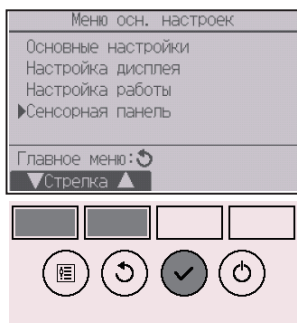

Выберите «Сенсорная панель» в Меню Основные настроек и нажмите кнопку **[ВЫБОР]**.

2

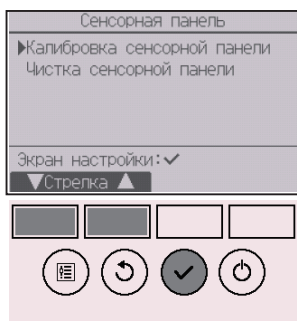

Переместите курсор на «Калибровка сенсорной панели» с помощью кнопки **[F1]** или **[F2]** и нажмите кнопку **[ВЫБОР]**.

3



Откроется окно с запросом подтверждения. Выберите «Отмена» или «OK» с помощью кнопки **[F3]** или **[F4]**, а затем нажмите кнопку **[ВЫБОР]**.

4

Касайтесь черных точек в том порядке, в котором они появляются на экране. Всего их будет девять.

Прикоснитесь стилусом к черным точкам в течение минуты, начиная с верхнего левого угла.

Касайтесь девяти черных точек в том порядке, в котором они появляются на экране.

После касания всех девяти точек калибровка завершится, а на экране снова отобразится меню сенсорной панели.

- Если не касаться сенсорной панели в течение одной минуты, калибровка будет отменена, а дисплей автоматически вернется к предыдущему экрану.
- Чтобы правильно откалибровать сенсорную панель, касайтесь точек остроконечным (но не острым) предметом.
 - * Острый предмет может повредить или поцарапать сенсорную панель.

Настройки функций

Чистка сенсорной панели



Кнопочное управление

1

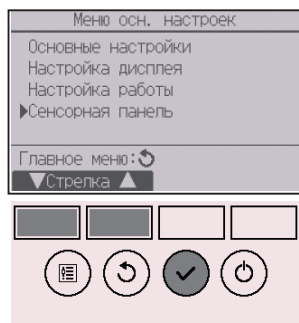

Выберите «Сенсорная панель» в Меню Основные настроек и нажмите кнопку **[ВЫБОР]**.

2

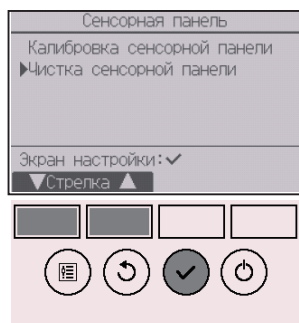

Переместите курсор на «Чистка сенсорной панели» с помощью кнопки **[F1]** или **[F2]** и нажмите кнопку **[ВЫБОР]**.

3

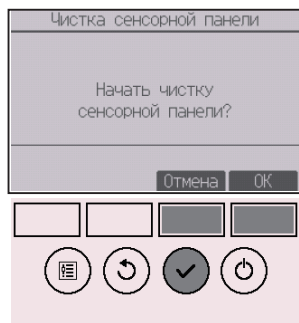

Откроется окно с запросом подтверждения. Выберите «Отмена» или «ОК» с помощью кнопки **[F3]** или **[F4]**, а затем нажмите кнопку **[ВЫБОР]**.

4

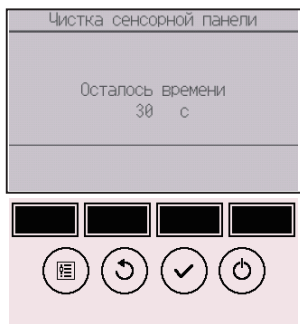

Этот экран позволяет пользователю протереть сенсорную панель в течение 30 секунд без случайного изменения настроек.

По истечении 30 секунд на экране снова отобразится меню сенсорной панели.

- Протрите сенсорную панель мягкой сухой тканью либо тканью, смоченной в воде с добавлением мягкого моющего средства или в этиловом спирте. Избегайте использования кислотных, щелочных или органических растворителей.

Настройки функций

Сброс дистанционного управления



Описание функции

Контроллер дистанционного управления можно сбросить до состояния, в котором он отправлялся с завода-изготовителя. Обратите внимание, что будут сброшены следующие данные.

Контроллер дистанционного управления автоматически перезапустится после сброса параметров.

Настройка «Таймер», настройка «Таймер на неделю», настройка «Тихий режим», настройка «Энергосбережение», настройка «Энергосбережение», настройка «Часы», настройка «Летнее время», настройка «Основной экран», настройка «Яркость», настройка «Информация на экране», настройка «Дизайн», настройка «Автоматический режим», настройка «Модели», настройка «Серийный номер», настройка «Информация о продавце», информация о неисправностях, пароль администратора, пароль на отладку.

Кнопочное управление

1

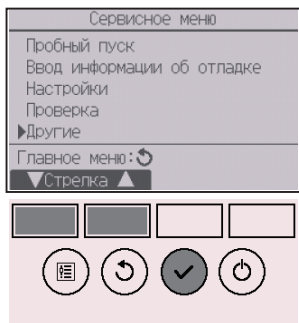

Выберите «Другие» в Сервисном меню и нажмите кнопку **ВЫБОР**.

2



Переместите курсор на «Сброс дистанц. управления» с помощью кнопки **F1** или **F2** и нажмите кнопку **ВЫБОР**.

3

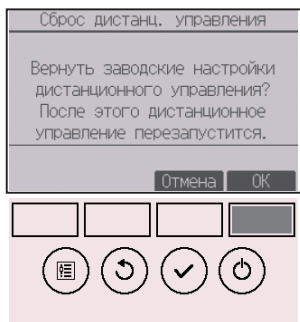

Выберите «OK» с помощью кнопки [F4].

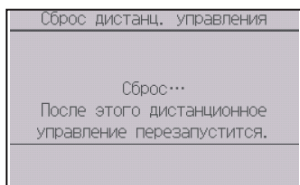

Контроллер дистанционного управления автоматически перезапустится после сброса параметров.

Настройки функций

Информации о дистанционного управления



Описание функции

Данный пункт позволяет просмотреть сведения об используемом контроллере дистанционного управления.

Кнопочное управление

1

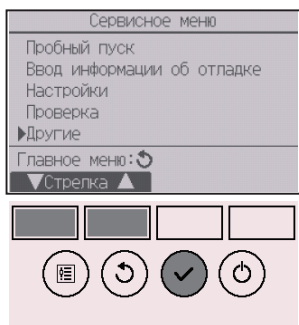

Выберите «Другие» в Сервисном меню и нажмите кнопку **[ВЫБОР]**.

2

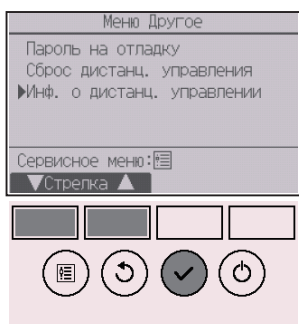

Переместите курсор на «Инф. о дистанц. управлении» с помощью кнопки **[F1]** или **[F2]** и нажмите кнопку **[ВЫБОР]**.

3

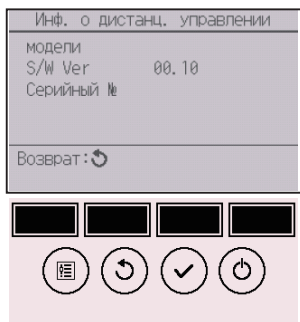

В итоге можно проверить модель, версию программного обеспечения и серийный номер контроллера дистанционного управления.

Устранение неисправностей

Информация о неисправностях

При возникновении ошибки отобразится следующее окно и замигает светодиодный индикатор работы. Проверьте статус ошибки, остановите работу и свяжитесь с дилером.

Кнопочное управление

1

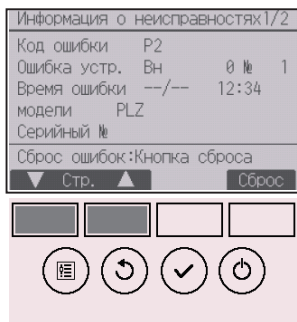

Будут отображены код ошибки, блок с ошибкой, адрес блока охлаждения, модель блока, дата и время возникновения ошибки, а также серийный номер.

Имя модели и серийный номер будут отображаться, только если эта информация была зарегистрирована.

Нажмите кнопку **[F1]** или **[F2]** для перехода на следующую страницу.

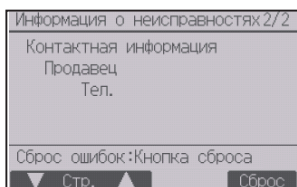

Контактная информация (номер телефона дилера) будет отображаться, если она была введена.

2

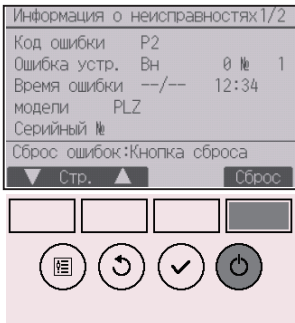

Нажмите кнопку **[F4]** или кнопку **[ВКЛ/ВЫКЛ]** для сброса произошедшей ошибки.

Сброс ошибки невозможен, если функция ВКЛ/ВЫКЛ запрещена.

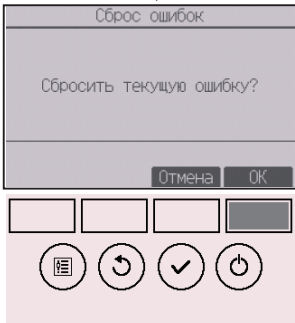

Выберите «ОК» с помощью кнопки **[F4]**.

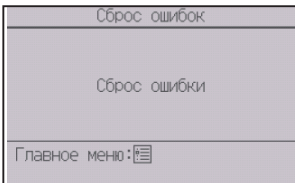

Откроется окно с запросом подтверждения.

Навигация по экранам

- Для возврата в Главное меню..... Кнопка **[МЕНЮ]**

Устранение неисправностей

Проверка информации о неисправностях



Если не возникло ошибок, страница 2/2 информации об ошибках (см. стр. 74) может быть просмотрена из меню. Выберите «Отладочное» меню в Главном меню и нажмите кнопку **ВЫБОР**.

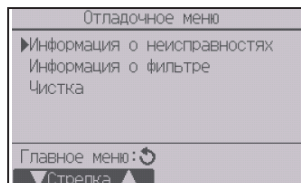

Для отображения экрана с информацией об ошибках выберите «Информация о неисправностях» в Отладочном меню. Сброс ошибки невозможен.

Автоотключение при незанятости

Следующий экран отображается на панели 3D i-See sensor при остановке блока в результате срабатывания функции Автооткл. при незанятости опции энергосбережения.

См. описание настройки 3D i-See sensor в руководстве по эксплуатации внутреннего блока.

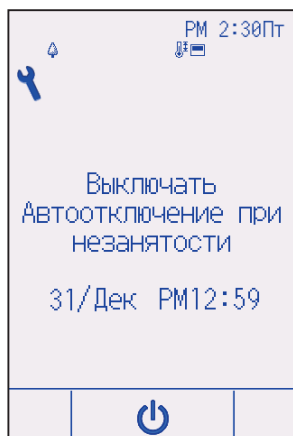

Отладка

Информация о фильтре



 отобразится на экране Состояния и на Основном экране в режиме «Полный», когда наступит время очистить фильтры.

Промойте, очистите или замените фильтры при появлении этого символа.

См. техническую документацию для внутреннего блока.

Кнопочное управление

1

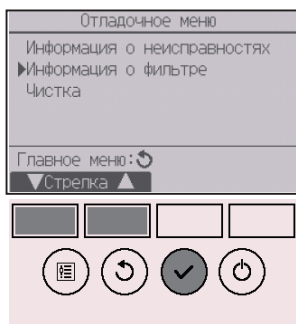

Выберите «Информация о фильтре» в Отладочном меню и нажмите кнопку **ВЫБОР**.

2

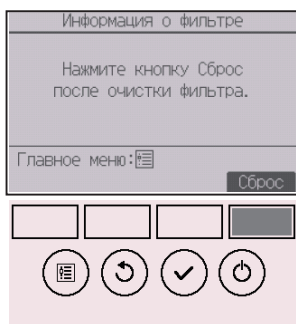

Для сброса значения фильтра нажмите кнопку **F4**. Сведения по очистке фильтра см. в технической документации к внутреннему блоку.

3

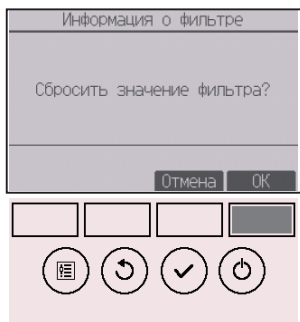

Выберите «ОК» с помощью кнопки **F4**.

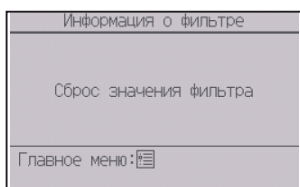

Откроется окно с запросом подтверждения.

Навигация по экранам

- Для возврата в Главное меню..... Кнопка **МЕНЮ**
- Для возврата к предыдущему экрану..... Кнопка **ВОЗВРАТ**



Когда  отобразится на экране Состояния и на Основном экране, настроенном на отображение в режиме «Полный», то система находится под централизованным управлением и значение фильтра не может быть сброшено.

Если подключены два или больше внутренних блока, время очистки фильтра для каждого блока может быть разным в зависимости от типа фильтра.

Значок  будет отображаться, когда необходимо выполнить очистку фильтра главного блока.

После сброса значения фильтра совокупное время работы всех блоков будет сброшено.

Значок  будет появляться через некоторое время работы, которое рассчитано исходя из предположения, что внутренний блок установлен в пространстве с обычным качеством воздуха. В зависимости от качества воздуха фильтр может потребовать более частую очистку.

Совокупное время, через которое фильтру требуется очистка, зависит от модели.

Технические характеристики

Технические характеристики контроллера

	Технические характеристики
Размер изделия	Стандартная версия (PAR-CT01MAA(R)-SB/PAR-CT01MAA-S): 65 (Ш) × 120 (В) × 14,1 (Г) мм (2 9/16 × 4 23/32 × 9/16 дюйма) (без учета выступающих частей)
	Премиум-версия (PAR-CT01MAA(R)-PB): 68 (Ш) × 120 (В) × 14,1 (Г) мм (2 11/16 × 4 23/32 × 9/16 дюйма) (без учета выступающих частей)
Масса нетто	Стандартная версия (PAR-CT01MAA(R)-SB/PAR-CT01MAA-S): 0,09 кг (13/64 фунта)
	Премиум-версия (PAR-CT01MAA(R)-PB): 0,10 кг (7/32 фунта)
Номинальная мощность напряжения питания	12 В постоянного тока (питание от внутренних блоков)
Потребление энергии	0,6 Вт
Рабочие условия окружающей среды	Температура 0 ~ 40°C (32 ~ 104°F) Относительная влажность 25 ~ 90% (без конденсации росы)
Материал	Стандартная версия (PAR-CT01MAA(R)-SB/PAR-CT01MAA-S) Основной корпус: акрилонитрилбутадиенстирол
	Премиум-версия (PAR-CT01MAA(R)-PB) Основной корпус: акрилонитрилбутадиенстирол Боковая пластина: алюминий

Список функций (по состоянию на 1 октября 2017 года)

○ : Поддерживается × : Не поддерживается

	Функция	CITY MULTI	Mr. SLIM	Запрос пароля
Питание	ВКЛ/ВЫКЛ питания	○	○	-
Настройки	Режим работы	○	○	-
	Режим «Авто» (два заданных значения)	○	○	-
	Заданная температура	○	○	-
	Скорость вентилятора	○	○	-
	Угол	○	○	-
	Жалюзи	○	○	-
	Вентиляция	○	○	-
Меню «Операция»	Максимальная мощность	×	○	-
	Ручная установка угла	○	○	-
	3D i-See sensor	○	○	-
Меню «Таймер»	Таймер (Таймер ВКЛ/ВЫКЛ)	○	○	администратор
	Таймер (Автоотключение таймера)	○	○	администратор
	Таймер на неделю	○	○	администратор
	Тихий режим	○	○	администратор
	Ночной режим	○	○	администратор
Меню «Энергосбережение»	Ограничение температурного диапазона	○	○	администратор
	Функция блокирования управления	○	○	администратор
	Автовозврат	○	○	администратор
	Расписание	×	○	администратор
Меню Основные настроек	Часы	○	○	администратор
	Настройка формата экрана настройки часов	○	○	администратор
	Летнее время	○	○	администратор
	Основной экран	○	○	администратор
	Описание значков	○	○	администратор
	Яркость	○	○	администратор
	Выбор языка	○	○	администратор
	Дизайн	○	○	администратор
	Калибровка сенсорной панели	○	○	администратор
	Чистка сенсорной панели	○	○	администратор
Пароль (администратор)	○	○	администратор	
Сервисное меню	Сброс дистанционного управления	○	○	отладка
	Информации о дистанционном управлении	○	○	отладка
	Пробный пуск	○	○	отладка
	Ввод информации о модели	○	○	отладка
	Ввод информации о дилере	○	○	отладка
	Настройка функций	○	○	отладка
	Тонкая отладка	×	○	отладка
	Пароль (отладка)	○	○	отладка
Отладочное меню	Автоматическое опускание панели	○	○	-
	Информация о неисправностях	○	○	-
	Информация о фильтре	○	○	-

* Набор поддерживаемых функций может меняться в зависимости от модели блока.

Технические характеристики

Список функций, которые могут (не могут) использоваться в сочетании

	Максимальная мощность	Таймер ВКЛ/ВЫКЛ	Автоотключение таймера	Таймер на неделю	Тихий режим	Диапазон температур	Функция блокирования управления	Автовозврат	Расписание работы в режиме энергосбережения	Ночной режим
Максимальная мощность		○	○	○	△ 1	○	△ 2	○	△ 1	○
Таймер ВКЛ/ВЫКЛ	○		○	× 1	○	○	○	○	○	△ 3
Автоотключение таймера	○	○		○	○	○	○	○	○	△ 4
Таймер на неделю	○	× 1	○		○	○	○	○	○	△ 5
Тихий режим	△ 1	○	○	○		○	○	○	○	○
Диапазон температур	○	○	○	○	○		○	× 2	○	△ 6
Функция блокирования управления	△ 2	○	○	○	○	○		○	○	○
Автовозврат	○	○	○	○	○	× 2	○		○	△ 7
Расписание работы в режиме энергосбережения	△ 1	○	○	○	○	○	○	○		○
Ночной режим	○	△ 3	△ 4	△ 5	○	△ 6	○	△ 7	○	

○: Может использоваться в сочетании ×: Не может использоваться в сочетании △: Ограничено

- △ 1: эта функция включается после завершения работы в режиме максимальной мощности, поскольку работа в режиме максимальной мощности имеет больший приоритет.
- △ 2: эта функция не может работать, если некоторые функции блокированы.
- △ 3: функция ночного режима не может использоваться, когда блок работает с включенной функцией «Таймер ВКЛ/ВЫКЛ».
- △ 4: функция автоотключения не может использоваться для работы с функцией ночного режима.
- △ 5: функция ночного режима не может использоваться, когда блок работает с включенной функцией «Таймер на неделю».
- △ 6: заданный температурный диапазон не может использоваться для работы с функцией ночного режима.
- △ 7: функция автовозврата не может использоваться для работы с функцией ночного режима.
- × 1: настройка таймера на неделю не будет иметь силы, потому что «Таймер ВКЛ/ВЫКЛ» имеет больший приоритет.
- × 2: функция автовозврата не может быть использована, поскольку настройка диапазона температур имеет больший приоритет.

Řídicí systém CITY MULTI
a klimatizační jednotky Mitsubishi Mr. SLIM

Vzdálená dotyková řídicí jednotka MA

PAR-CT01MAA-PB

PAR-CT01MAA-SB

PAR-CT01MAA-S

PAR-CT01MAR-PB

PAR-CT01MAR-SB

Instrukční příručka

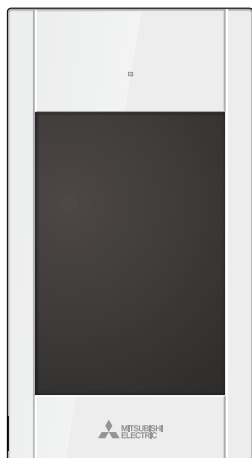

Český

Před použitím si pozorně přečtěte pokyny v této příručce, abyste používali výrobek správně.
Uschovejte příručku pro další použití.

Zajistěte předání tohoto disku CD-ROM a instalační příručky všem budoucím uživatelům.



V zájmu zaručení bezpečného a řádného provozu smí vzdálenou řídicí jednotku instalovat pouze kvalifikovaná osoba.

Obsah

Bezpečnostní opatření	4
Součástí řídicí jednotky	6
Rozhraní řídicí jednotky - Zobrazení stavu/Hlavní zobrazení	6
Rozhraní řídicí jednotky - obrazovka Menu	8
Displej - Zobrazení stavu/Hlavní zobrazení	10
Struktura a ikony nabídek.....	12
Struktura nabídek	12
Vysvětlení ikony	15
Základní úkony	16
Zapnutí/vypnutí napájení	16
Nastavení provozního režimu, teploty, rychlosti ventilátoru, žaluzie 1, žaluzie 2 a rekuperace (Lossnay).....	17
Procházení nabídkami.....	22
Seznam položek Hlavního menu	22
Procházení položkami nabídky Hlavní menu.....	24
Nastavení funkcí.....	25
Vysoký výkon	25
Ruční nastavení Žaluzie 1	26
Časovač (On/Off časovač).....	29
Časovač (Časovač automatického vypnutí)	32
Týdenní časovač.....	34
Tichý režim venkovní jednotky.....	37
Noční pokles teploty	40
Omezení	43
Úspora energie	49
Čas.....	54
Letní čas	56
Hlavní zobrazení	58
Vysvětlení ikony	59
Jas	61
Volba jazyka.....	62
Vzhled	64
Kalibrace dotykového panelu.....	66
Čištění dotykového panelu	68
Inicializace dálkového ovládání	70
Informace o dálkovém ovládání	72
Řešení problémů	74
Informace o chybě	74
Automatické vypnutí při nepřítomnosti.....	77
Údržba	78
Informace o filtru	78
Specifikace	80
Specifikace řídicí jednotky	80
Seznam funkcí (k 1. říjnu 2017).....	81
Seznam funkcí, které lze/nelze používat současně.....	82

Bezpečnostní opatření

- Před použitím jednotky si pozorně přečtěte následující bezpečnostní opatření.
- V zájmu zajištění bezpečnosti pečlivě dodržujte tato opatření.

 VÝSTRAHA	Označuje nebezpečí usmrcení nebo vážného zranění.
 UPOZORNĚNÍ	Označuje nebezpečí vážného zranění nebo poškození konstrukce.

- Po přečtení předejte tuto příručku koncovému uživateli pro další použití.
- Uchovejte tuto příručku pro další použití a v případě potřeby do ní nahlédněte. K této příručce musí mít přístup osoby pověřené opravami nebo přemístěním jednotky. Zajistěte, aby byla příručka předána všem budoucím uživatelům.

Obecná opatření

VÝSTRAHA

Jednotku neinstalujte do míst s přítomným velkým množstvím olejů, par, organických rozpouštědel nebo korozivních plynů (například siriých plynů), ani do míst, kde se často používají kyselé/zásadité roztoky nebo spreje. Tyto látky mohou ovlivnit výkon jednotky nebo způsobit korozi jistých součástí jednotky s možným následkem elektrického úrazu, poruchy, vzniku kouře nebo požáru.

Řídicí jednotku neoplachujte vodou ani jinou kapalinou, aby nedošlo ke zkratu, k úniku proudu, úrazu elektrickým proudem, poruchám, ke vzniku kouře nebo požáru.

Nedotýkejte se spínačů nebo tlačítek ani jiných elektrických součástí mokřýma rukama, aby nedošlo k úrazu elektrickým proudem, poruchám, ke vzniku kouře nebo požáru.

Při dezinfikování jednotky alkoholem zajistěte náležitě větrání místnosti. Alkoholové výpary kolem jednotky by mohly po zapnutí jednotky způsobit požár nebo výbuch.

Aby se snížilo nebezpečí zranění nebo úrazu elektrickým proudem, před rozstříkáním chemického prostředku kolem řídicí jednotky tuto jednotku vypněte a zakryjte.

Aby se snížilo nebezpečí zranění nebo úrazu elektrickým proudem, před čištěním, údržbou nebo kontrolou zastavte jednotku a vypněte napájení.

Pokud zaznamenáte jakoukoliv anomálii (např. ucítíte, že se něco páli), vypněte síťový vypínač a obraťte se na svého prodejce. Další používání výrobku by mohlo vést k úrazu elektrickým proudem, poruchám nebo požáru.

Správně nainstalujte všechny potřebné kryty, aby do řídicí jednotky nepronikly vlhkost a prach. Usazený prach a voda mohou způsobit úraz elektrickým proudem, vznik kouře nebo požáru.

UPOZORNĚNÍ

Aby se snížilo nebezpečí vzniku požáru nebo výbuchu, v okolí řídicí jednotky neukládejte žádné vznětlivé materiály a nepoužívejte vznětlivé spreje.

Aby se snížilo nebezpečí poškození řídicí jednotky, nespíchejte přímo na ni žádné prostředky na hubení hmyzu ani jiné vznětlivé spreje.

Aby se snížilo nebezpečí znečištění životního prostředí, zjistěte si od pověřené instituce náležitý způsob likvidace vzdálené řídicí jednotky.

Nedotýkejte se panelů, spínačů nebo tlačítek špičatými ani ostrými předměty, aby se snížilo nebezpečí úrazu elektrickým proudem nebo poruch.

Vyhňte se kontaktu s ostrými hranami určitých částí, aby se snížilo nebezpečí zranění a úrazu elektrickým proudem.

Na skleněné části netlačte nadměrnou silou, abyste se neporanili o sklo.

Aby se snížilo nebezpečí zranění, při práci na řídicí jednotce noste ochranné prostředky.

Opatření týkající se přemístění nebo opravy řídicí jednotky

VÝSTRAHA

Řídicí jednotku může opravovat nebo přemísťovat jen kvalifikovaná osoba. Řídicí jednotku nedemontujte ani neopravujte. Nesprávná instalace nebo oprava může vést ke zranění, úrazu elektrickým proudem nebo požáru.

UPOZORNĚNÍ

Aby se snížilo nebezpečí vzniku zkratu, úrazu elektrickým proudem, požáru nebo závady, nedotýkejte se obvodové desky nástroji ani rukama a chraňte ji před hromaděním prachu.

Doplňující opatření

Při instalaci, kontrole nebo opravě řídicí jednotky použijte vhodné nástroje, aby nedošlo k jejímu poškození.

Tato řídicí jednotka je určena k použití výhradně se systémem řízení budovy (Building Management System) společnosti Mitsubishi Electric. Použití této řídicí jednotky s jinými systémy nebo pro jiné účely může vést ke vzniku závad.

Toto zařízení nesmí používat osoby (včetně dětí) se sníženou fyzickou, smyslovou nebo duševní schopností, bez dostatečných zkušeností a znalostí, pokud nejsou pod dohledem nebo nebyly proškoleny o používání zařízení osobou, která nese za jejich bezpečnost odpovědnost. Děti musí být pod dohledem, aby bylo zaručeno, že si se zařízením nebudou hrát.

K čištění řídicí jednotky nepoužívejte benzen, ředidlo ani chemickou utěrku, aby nedošlo ke změně zabarvení. Chcete-li řídicí jednotku vyčistit, otřete ji měkkou tkaninou namočenou ve vodě se slabým čisticím prostředkem, poté čisticí prostředek otřete vlhkým hadříkem a vodu otřete suchým hadříkem.

Zajistěte ochranu proti statické elektřině, aby nedošlo k poškození řídicí jednotky.

Předpokládání uživatelé zařízení jsou odborníci nebo školení uživatelé v dílnách, v lehkém průmyslu nebo na farmách nebo laici pro komerční účely.

Je-li napájecí kabel poškozený, musí jej z důvodu bezpečnosti vyměnit výrobce, jeho servisní zástupce nebo obdobně kvalifikované osoby.

Součástí řídicí jednotky

Rozhraní řídicí jednotky - Zobrazení stavu/Hlavní zobrazení

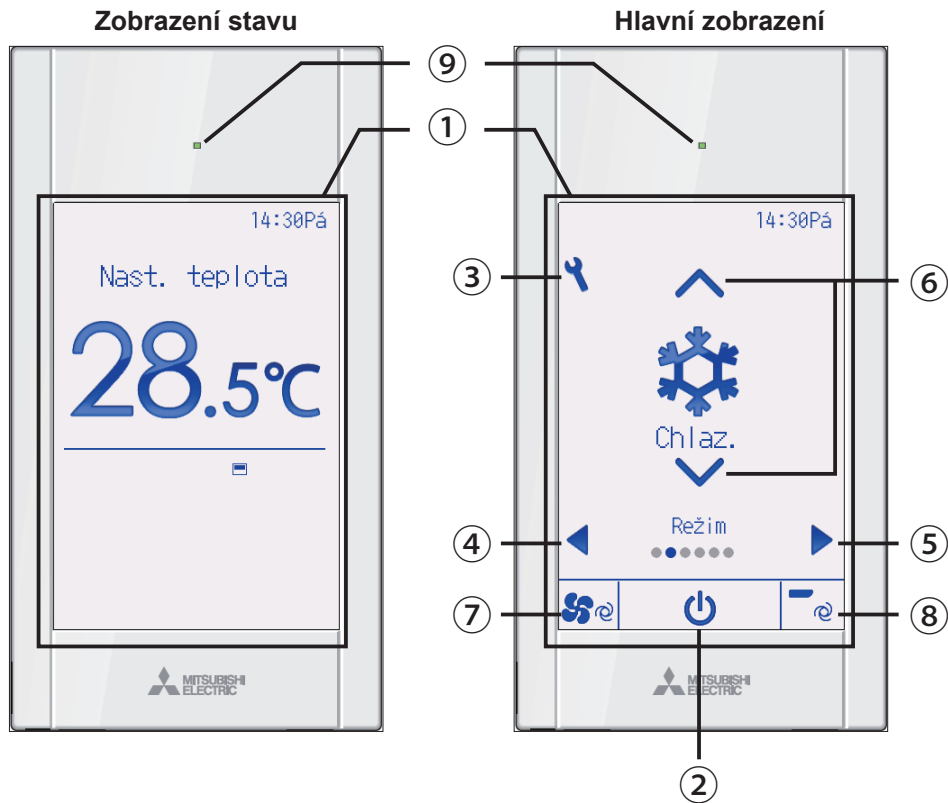

① Dotykový panel a podsvícený barevný LCD

Zobrazí se provozní nastavení. Když je vypnuté podsvícení, po stisknutí jakékoli části se obrazovka změní na Zobrazení stavu. Během zobrazování Zobrazení stavu se po stisknutí jakékoli části obrazovka změní na Hlavní zobrazení.

② Tlačítko ZAP/VYP

Stisknutím zapnete/vypnete vnitřní jednotku.

③ Tlačítko Nastavení

Stisknutím vyvolejte Hlavní menu. Když je ovládání nabídky blokováno, vyžaduje se Admin heslo.

④ Tlačítko ◀

Stisknutím přepínáte položky nastavení v následujícím pořadí: žaluzie 2, rekuperace, žaluzie 1, rychlost ventilátoru, provozní režim a předvolená teplota.

⑤ Tlačítko ▶

Stisknutím přepínáte položky nastavení v následujícím pořadí: předvolená teplota, provozní režim, rychlost ventilátoru, žaluzie 1, rekuperace, žaluzie 2.

⑥ Tlačítka ▲ ▼

Stisknutím změňte obsah nastavení vybraného výše v krocích ④ a ⑤.

⑦ Tlačítko zástupce Rychlost ventilátoru

Stisknutím vstupte přímo na obrazovku nastavení rychlosti ventilátoru.

⑧ Tlačítko zástupce Žaluzie 1

Používá se k přímému přístupu na obrazovku nastavení žaluzie 1.

⑨ Kontrolka Zapnuto/vypnuto

Tato kontrolka svítí zeleně, když je jednotka v provozu, pokud není „LED osvětlení“ nastaveno na „Ne“. Bliká během spouštění řídicí jednotky nebo v případě výskytu chyby.

Když je ovládání zapnutí/vypnutí uzamčeno, tlačítko ② se nezobrazuje.

Když se tlačítkem ④ nebo ⑤ přepne položka nastavení a pokud je ovládání vybrané položky nastavení uzamčeno, tato položka se nezobrazí.

Pokud je uzamčeno ovládání rychlosti ventilátoru nebo žaluzie 1, položka ⑦ nebo ⑧ se nezobrazí.

Když je položka nastavení centrálně řízena systémovým ovladačem, obsah nastavení nelze měnit tlačítkem ⑥.

Součástí řídicí jednotky

Rozhraní řídicí jednotky - obrazovka Menu



① Tlačítko **ZAP/VYP**

Stisknutím zapnete/vypnete vnitřní jednotku.

② Tlačítko **VYBRAT**

Stisknutím uložíte nastavení.

③ Tlačítko **NÁVRAT**

Stisknutím se vrátíte na předchozí obrazovku. Když je zobrazeno Hlavní menu, stisknutím tohoto tlačítka se zobrazí Zobrazení stavu.

④ Tlačítko **MENU**

Strana 24

Stisknutím vyvolejte Hlavní menu.

⑤ Tlačítko funkce **F1**

Obrazovka Menu: Funkce tohoto tlačítka se liší podle konkrétní obrazovky.

⑥ Tlačítko funkce **F2**

Hlavní menu: Stisknutím přesuňte kurzor doleva.

Obrazovka Menu: Funkce tohoto tlačítka se liší podle konkrétní obrazovky.

⑦ Tlačítko funkce **F3**

Hlavní menu: Stisknutím přesuňte kurzor doprava.

Obrazovka Menu: Funkce tohoto tlačítka se liší podle konkrétní obrazovky.

⑧ Tlačítko funkce **F4**

Obrazovka Menu: Funkce tohoto tlačítka se liší podle konkrétní obrazovky.

Funkce funkčních tlačítek se mění v závislosti na konkrétní obrazovce. Řiďte se popisy funkcí tlačítek na spodním řádku LCD, které uvádějí, k jakým funkcím slouží tlačítka pro danou obrazovku.

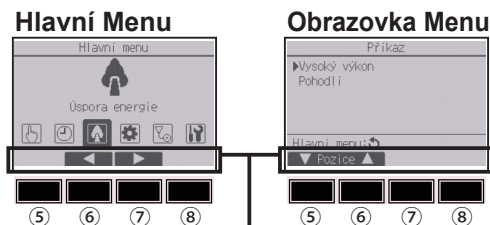

Popis funkcí

Součástí řídicí jednotky

Displej - Zobrazení stavu/Hlavní zobrazení

Zobrazení stavu a Hlavní zobrazení lze zobrazovat ve dvou různých režimech: „Plné“ a „Základní“.
Od výrobce je nastaven režim „Plné“. Způsob přepínání režimů najdete na straně 58.

Režim Plné

* Kvůli názornosti jsou zobrazeny všechny ikony.

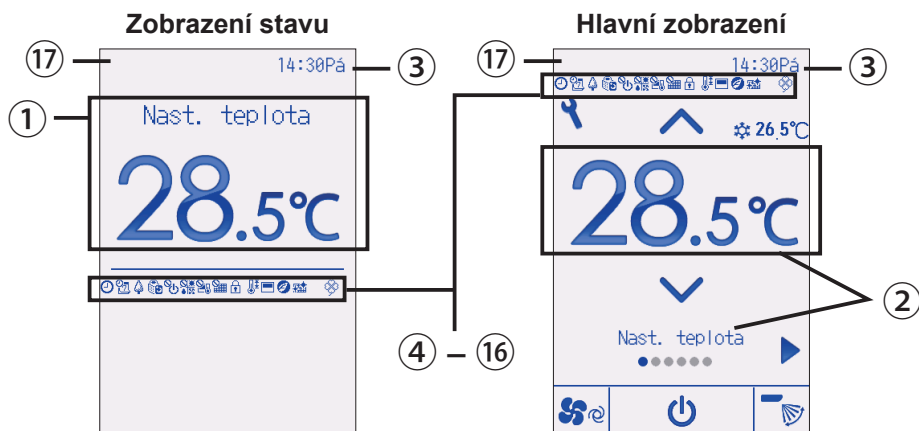

Režim Základní

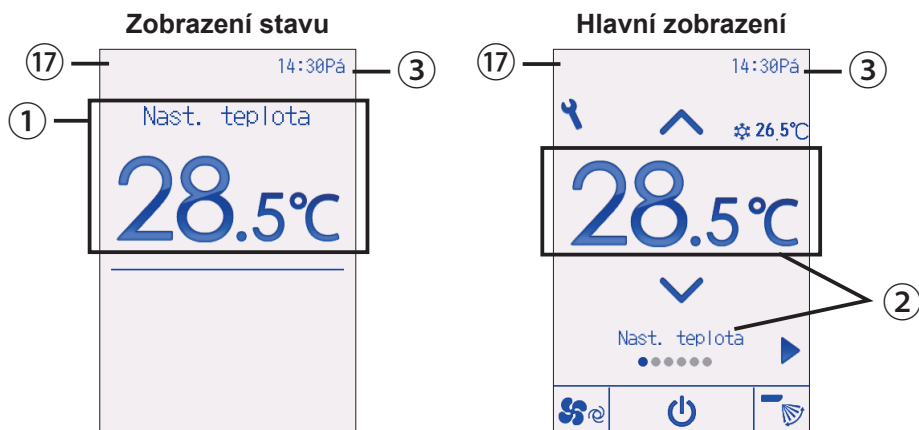

1 Předvolená nebo pokojová teplota

Zde se zobrazuje předvolená nebo pokojová teplota.
(Viz instalační příručka.)

2 Položka a obsah nastavení Strana 17

Zde se zobrazují položky nastavení „Předvolená teplota“ ↔ „Provozní režim“ ↔ „Rychlost ventilátoru“ ↔ „Žaluzie 1“ ↔ „Rekuperace“ ↔ „Žaluzie 2“ a jejich obsah. Po určitou dobu, kdy je ovládána centrálně řízená položka, se zobrazuje text „Centrálně řízeno“.

3 Čas

Zde se zobrazuje aktuální čas.
(Viz instalační příručka.)

4 Strana 29, 32, 40

Zobrazuje se v případě, že je aktivován „On/Off časovač“ (Strana 29), funkce „Noční pokles teploty“ (Strana 40) nebo „Časovač automatického vypnutí“ (Strana 32).

 se zobrazuje, když je časovač vypnut centrálně řízeným systémem.

5 Strana 34

Zobrazuje se v případě, že je aktivován Týdenní časovač.

6 Strana 51

Zobrazuje se, když jednotky pracují v úsporném režimu. (Na některých modelech vnitřních jednotek se nezobrazí.)

7 Strana 37

Zobrazuje se, když venkovní jednotky pracují v tichém režimu.

8

Zobrazuje se v případě centrálně řízeného zapínání/vypínání.

9

Zobrazuje se v případě centrálně řízeného provozního režimu.

10

Zobrazuje se v případě centrálně řízené předvolené teploty.

11

Zobrazuje se v případě centrálně řízené funkce resetování filtru.

12 Strana 46

Zobrazuje se, když jsou tlačítka uzamčena.

13 Strana 43

Zobrazuje se v případě omezeného rozsahu předvolených teplot.

14

Zobrazuje se, když je aktivován vestavěný termistor ve vzdálené řídicí jednotce, aby monitoroval pokojovou teplotu.

 se zobrazuje, když je aktivován termistor ve vnitřní jednotce, aby monitoroval pokojovou teplotu.

15

Zobrazí se když se provede operace úspory energie pomocí funkce „3D i-See sensor“.

16 Strana 78

Signalizuje, že je nutná údržba filtru.

17 Zobrazení předběžné chyby

Během předběžné chyby se zobrazuje chybový kód.

Struktura a ikony nabídek

Struktura nabídek

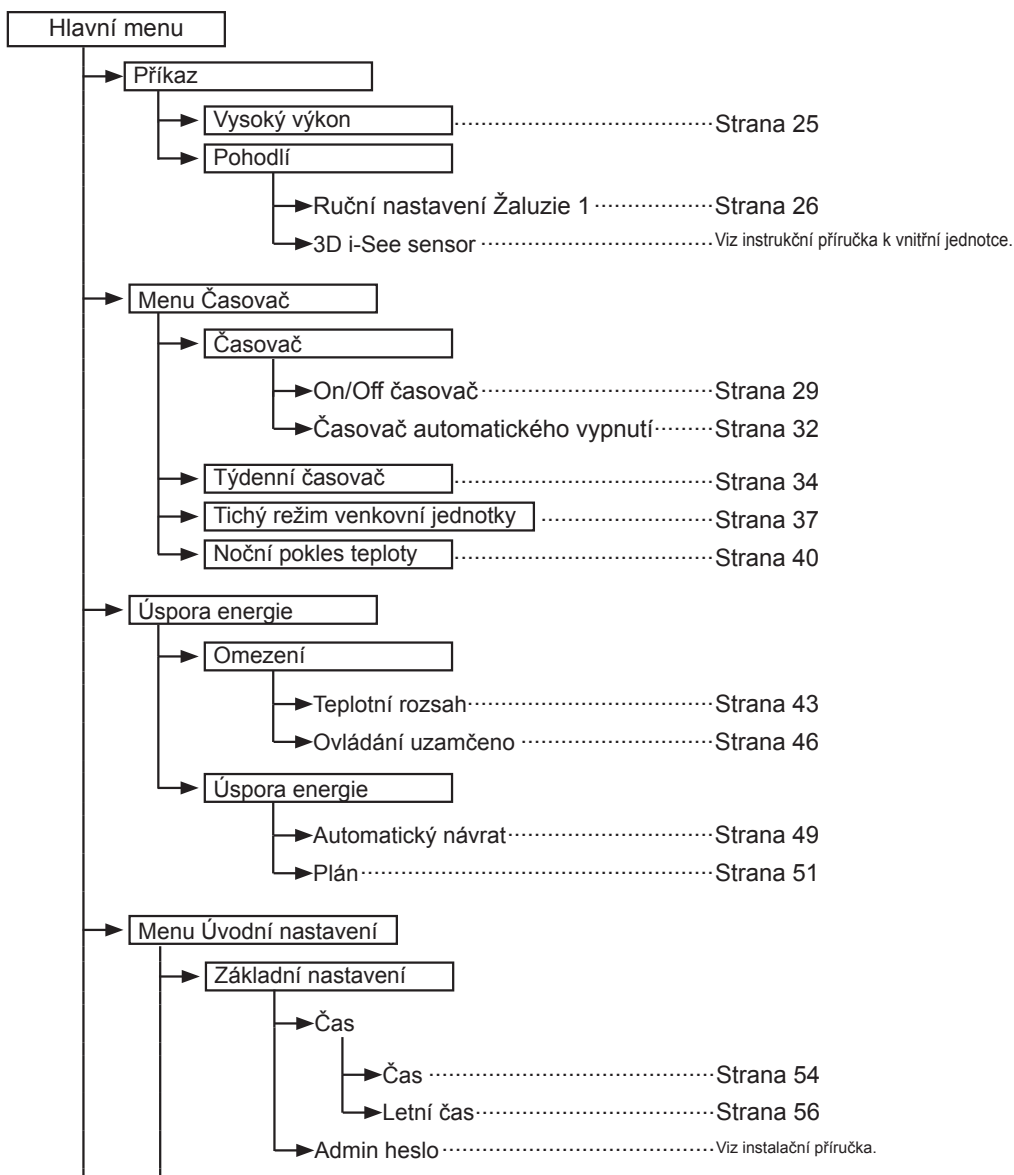

→	Nastavení displeje	
	→	Hlavní zobrazení Strana 58
	→	Podrobnosti zobrazení (Vysvětlení ikony atd.) ... Viz instalační příručka.
	→	Jas Strana 61
	→	Volba jazyka Strana 62
	→	Vzhled Strana 64
→	Provozní nastavení	
	→	Automatický režim Viz instalační příručka.
→	Dotykový panel Strana 66
→	Menu Údržba	
	→	Informace o chybě Strana 74
	→	Informace o filtru Strana 78
	→	Čištění
		→ Auto-spouštění filtru Viz instrukční příručka dodaná s automaticky stoupajícím panelem.
		→ Ovládání spouštění Viz instrukční příručka dodaná s automaticky stoupajícím panelem.
		→ Upravit spouštění Viz instrukční příručka dodaná s automaticky stoupajícím panelem.
→	Servisní menu	
	→	Test run menu
		→ Test run Viz instalační příručka k vnitřní jednotce.
		→ Test run čerpadla kondenzátu Viz instalační příručka k vnitřní jednotce.
	→	Informace o údržbě Viz instalační příručka k vnitřní jednotce.
		→ Zadání modelu zařízení Viz instalační příručka k vnitřní jednotce.
		→ Zadání výrobního čísla Viz instalační příručka k vnitřní jednotce.
		→ Zadání informací o prodejci Viz instalační příručka k vnitřní jednotce.
		→ Nastavení informací o údržbě Viz instalační příručka k vnitřní jednotce.

Struktura a ikony nabídek

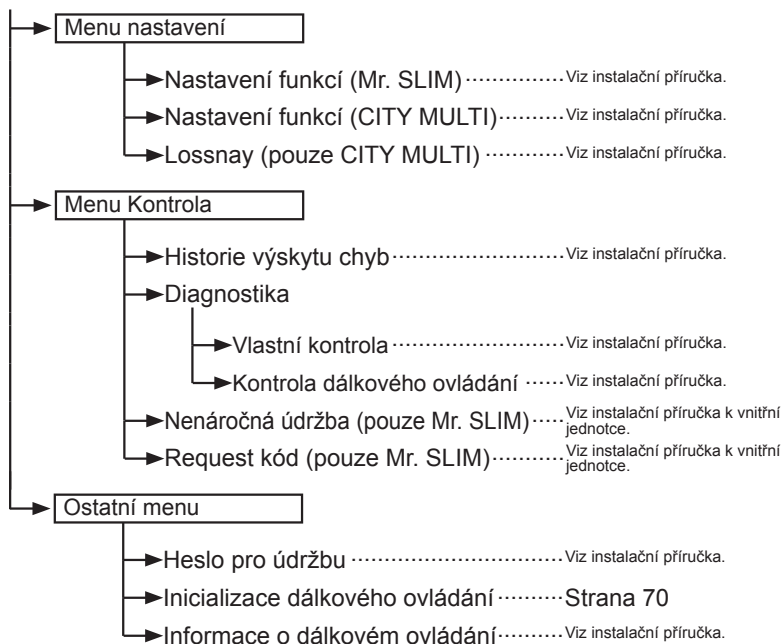

Všechny modely vnitřních jednotek nejsou vybaveny všemi funkcemi.

Ovládání řídicí jednotky

Časovač



Následující tabulka obsahuje souhrnný přehled ikon použitých v této příručce.



Pro změnu nastavení je nutné zadat heslo správce nebo heslo pro údržbu na obrazovce pro zadání hesla. Neexistují žádná nastavení, která by mohla tento postup přeskočit.

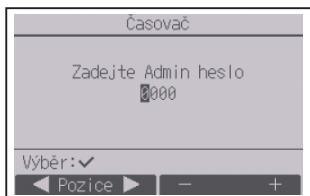

F1 F2 F3 F4

- F1** : Stisknutím přesuňte kurzor doleva.
- F2** : Stisknutím přesuňte kurzor doprava.
- F3** : Stisknutím snižte hodnotu o 1.
- F4** : Stisknutím zvýšte hodnotu o 1.

* Dokud nebude zadáno správné heslo, nelze provádět změny.



Označuje nastavení, která lze měnit pouze za provozu jednotek.



Označuje nastavení, která lze měnit pouze tehdy, když jednotky nejsou v provozu.



Označuje nastavení, která lze měnit pouze tehdy, když jednotky pracují v režimu Chlazení, Topení nebo Auto.



Označujte funkce, které nejsou k dispozici, když jsou uzamčena tlačítka nebo je systém řízen centrálně.

Základní úkony

Zapnutí/vypnutí napájení



Ovládání pomocí tlačítek

Zapnuto



Tlačítko **ZAP/VYP**

Stiskněte tlačítko **ZAP/VYP**.

Rozsvítí se zelená kontrolka Zapnuto/vypnuto a spustí se systém.

Když je položka „LED osvětlení“ nastavena na „Ne“, kontrolka Zapnuto/vypnuto se nerozsvítí.

Vypnuto



Znovu stiskněte tlačítko **ZAP/VYP**.

Kontrolka Zapnuto/vypnuto zhasne a systém se zastaví.



Ovládání pomocí tlačítek

Provozní režim



Každým stisknutím tlačítka ▼ nebo ▲ se cyklicky přechází mezi následujícími režimy.

Vyberte požadovaný provozní režim.



Chlazení



Odvlhčování



Ventilátor



Auto



Topení

- Na displeji se nezobrazují režimy, které nejsou k dispozici pro připojené modely vnitřních jednotek.

Co znamená blikající ikona režimu

Ikona režimu bude blikat v případě, že ostatní vnitřní jednotky v systému se stejným chladičem (připojené ke stejné venkovní jednotce) již pracují v jiném režimu. V tomto případě mohou ostatní jednotky ve stejné skupině pracovat pouze v tomto režimu.

<Režim Auto (duální nastavení)>

Pokud je provozní režim nastaven na „Auto“ (duální nastavení), lze zvolit dvě předvolené teploty (jednu pro chlazení a jednu pro topení). V závislosti na teplotě v místnosti bude vnitřní jednotka automaticky pracovat buď v režimu Chlazení, nebo v režimu Topení, a bude udržovat teplotu v místnosti v předvoleném rozsahu.

Graf níže zobrazuje vzor provozu vnitřní jednotky pracující v režimu Auto (duální nastavení).

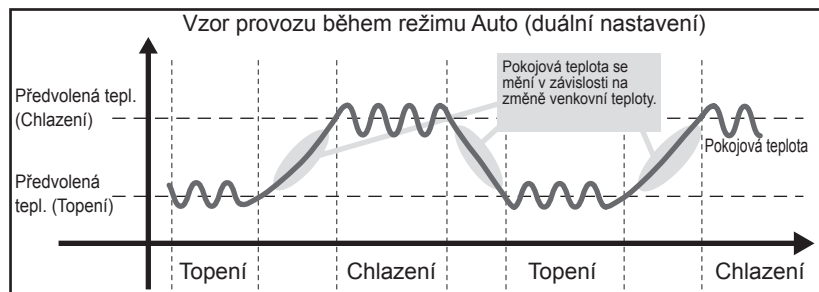

Základní úkony

Předvolená teplota

<Chlazení, Odvlhčování, Topení a Auto (jednoduché nastavení)>



Stisknutím tlačítka ▼ snížíte předvolenou teplotu a stisknutím tlačítka ▲ ji zvýšíte.

- Nastavitelné rozsahy teplot pro různé provozní režimy najdete v tabulce na str. 19.
- Rozsah předvolených teplot nelze nastavit pro režim Ventilátor/Rekuperace.
- Předvolená teplota bude zobrazena buď ve stupních Celsia v přírůstcích po 0,5 či 1 stupni, nebo ve stupních Fahrenheita v závislosti na modelu vnitřní jednotky a režimu nastavení zobrazení na vzdálené řídicí jednotce.

<Režim Auto (duální nastavení)>

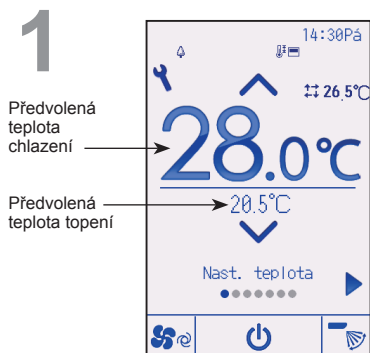

Zobrazí se aktuální předvolené teploty.

Každým stisknutím tlačítka ◀ nebo ▶ se přepnou předvolené teploty pro chlazení a topení.

2

Předvolená
teplota
chlazení

Předvolená
teplota
topení

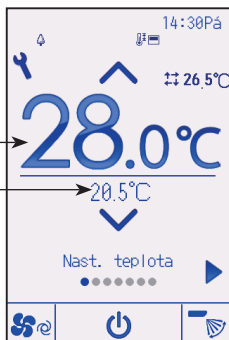

Stisknutím tlačítka ▼ snížíte vybranou teplotu a stisknutím tlačítka ▲ ji zvýšíte.

- Nastavitelné rozsahy tepot pro různé provozní režimy najdete níže v tabulce.
- Předvolené teploty pro chlazení a topení v režimu Auto (duální nastavení) jsou také použity v režimech Chlazení/Odvlhčování a Topení.
- Předvolené teploty pro chlazení a topení v režimu Auto (duální nastavení) musí splňovat podmínky uvedené níže:
 - Předvolená teplota chlazení je vyšší než předvolená teplota topení.
 - Je splněn požadavek minimálního rozdílu mezi předvolenými teplotami chlazení a topení (liší se podle modelů připojených vnitřních jednotek).
 - Jestliže jsou předvolené teploty nastaveny tak, že nespĺňují požadavek na minimální teplotní rozdíel, automaticky se obě změní v rámci přípustných rozsahů nastavení.

Nastavitelný rozsah předvolených teplot

Provozní režim	Rozsah předvolených teplot
Chlazení/Odvlhčování	19 ~ 30°C (67 ~ 87°F)
Topení	17 ~ 28°C (63 ~ 83°F)
Auto (Jednoduché nastavení)	19 ~ 28°C (67 ~ 83°F)
Auto (Duální nastavení)	[Chlazení] Předvolený teplotní rozsah pro režim Chlazení [Topení] Předvolený teplotní rozsah pro režim Topení
Ventilátor/Rekuperace	Nenastavuje se

Nastavitelný rozsah teplot se liší podle modelů vnitřních jednotek.

Základní úkony

Rychlost ventilátoru

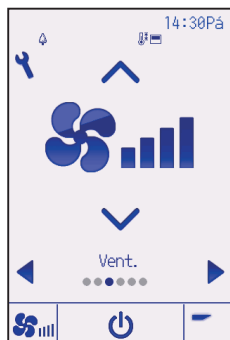

Každým stisknutím tlačítka ▼ nebo ▲ se cyklicky přechází mezi následujícími rychlostmi ventilátoru.

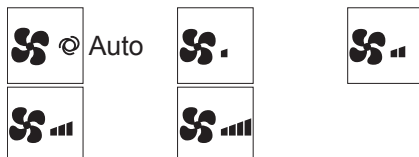

- Dostupná rychlost ventilátoru závisí na modelech připojených vnitřních jednotek.

Nastavení Žaluzie 1



(Příklad obrazovky na modelu CITY MULTI)

Každým stisknutím tlačítka ▼ nebo ▲ se cyklicky přechází mezi následujícími nastaveními žaluzie 1.

Vyberte požadované nastavení.

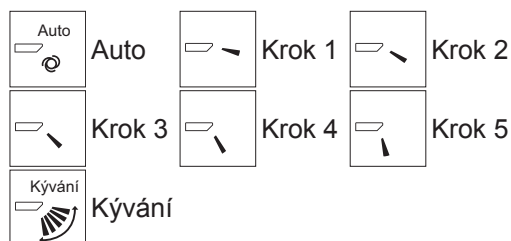

Chcete-li, aby se lopatky automaticky pohybovaly nahoru a dolů, vyberte „Kývání“.

Při nastavení na „Krok 1“ až „Krok 5“ budou lopatky trvale ve zvoleném úhlu.

- **1h** vlevo vedle ikony nastavení žaluzie 1 Tato ikona se zobrazí, když je žaluzie 1 nastavena na Krok 2, 3, 4 nebo 5 a ventilátor běží s nízkými otáčkami během chlazení nebo odvlhčování (v závislosti na modelu). Během jedné hodiny ikona zmizí a nastavení žaluzie 1 se automaticky změní.

Nastavení Žaluzie 2

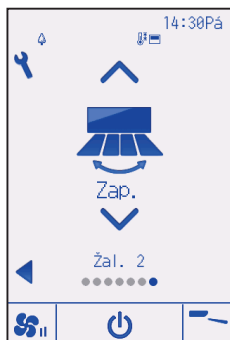

(Příklad obrazovky na modelu CITY MULTI)

Stisknutím tlačítka ▼ nebo ▲ zapnete nebo vypnete kývání žaluzie 2.



Nastavení Rekuperace

Rekuperaci lze nastavovat, i když jsou jednotky v provozu.

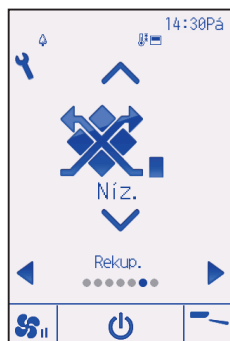

(Příklad obrazovky na modelu Mr. SLIM)

Každým stisknutím tlačítka ▼ nebo ▲ se cyklicky přechází mezi následujícími nastaveními rekuperace.

* Lze nastavit pouze v případě, že je připojena jednotka Lossnay.



• Ventilátor v některých modelech vnitřních jednotek může být vázán na určité modely ventilačních jednotek.

Procházení nabídkami

Seznam položek Hlavního menu

Hlavní menu	Položky nastavení		Informace o nastavení	Strana
Příkaz	Vysoký výkon		Používá se k rychlému dosažení příjemné pokojové teploty. • Jednotky mohou pracovat v režimu vysokého výkonu po dobu až 30 minut.	25
	Pohodlí	Ruční nastavení Žaluzie 1	Používá se k nastavení úhlu žaluzie 1.	26
Časovač	Časovač	On/Off časovač	Používá se k nastavení času zapnutí/vypnutí. • Čas lze nastavovat v pětiminutových krocích. * Je nutné nastavit čas.	29
		Časovač automatického vypnutí	Používá se k nastavení času automatického vypnutí. • Čas lze nastavovat v desetiminutových krocích od 30 do 240 minut.	32
	Týdenní časovač		Používá se k nastavení časů zapnutí/vypnutí během týdne. • Pro každý den lze nastavit až osm provozních vzorů. • Lze nastavit dva typy týdenních plánů. * Je nutné nastavit čas. * Neúčinný při aktivaci On/Off časovač. * 1°C přírůsteky	34
	Tichý režim venkovní jednotky		Používá se k nastavení časových intervalů, v nichž má tichý provoz venkovních jednotek přednost před regulací teploty. Nastavte časy Začátek/Konec pro každý den v týdnu. • Vyberte požadovanou úroveň tichého provozu „Norm“, „Střední“ nebo „Tichý“. * Je nutné nastavit čas.	37
	Noční pokles teploty		Používá se k nastavování Nočního poklesu teploty. • Volbou „Ano“ aktivujete nastavení a volbou „Ne“ ho deaktivujete. Lze nastavit rozsah teplot a časy spuštění/zastavení. * Je nutné nastavit čas. * 1°C přírůsteky	40
Úspora energie	Omezení	Teplotní rozsah	Používá se k omezení rozsahu předvolených teplot. • Lze nastavit různé pracovní teploty pro různé provozní režimy. * 1°C přírůsteky	43
		Ovládání uzamčeno	Používá se k uzamykání vybraných funkcí. • Uzamčené funkce se nedají ovládat.	46
	Úspora energie	Automatický návrat	Používá se k nastavení jednotek na předvolenou teplotu poté, co po stanovenou dobu pracovaly v úsporném režimu. • Čas lze nastavovat v desetiminutových krocích od 30 do 120 minut. * Když jsou omezeny rozsahy předvolených teplot, tato funkce nebude účinná. * 1°C přírůsteky	49

Hlavní menu	Položky nastavení		Informace o nastavení	Strana	
Úspora energie	Úspora energie	Plán	Nastavte časy Začátek/Konec pro provoz jednotek v úsporném režimu na každý den v týdnu a nastavte míru úspory energie. <ul style="list-style-type: none"> • Pro každý den lze nastavit až čtyři vzory úsporného provozu. • Čas lze nastavovat v pětiminutových krocích. • Míru úspory energie lze nastavovat v desetiprocentních krocích na hodnoty 0% a 50 až 90%. * Je nutné nastavit čas.	51	
		Úvodní nastavení	Základní nastavení	Čas	Používá se k nastavení aktuálního času.
			Letní čas	Nastaví letní čas.	56
	Nastavení displeje	Hlavní zobrazení	Používá se k přepínání režimů hlavního zobrazení „Plné“ a „Základní“ pro Zobrazení stavu a Hlavní zobrazení. <ul style="list-style-type: none"> • Od výrobce je nastaven režim „Plné“. 	58	
		Jas	Používá se k nastavení jasu displeje.	61	
		Volba jazyka	Používá se k výběru požadovaného jazyka.	62	
		Vzhled	Používá se ke změně barvy obrazovek Zobrazení stavu a Hlavní zobrazení.	64	
	Dotykový panel	Kalibrace dotykového panelu	Nastavuje parametry pro kalibraci dotykového panelu.	66	
		Čištění dotykového panelu	Dočasně deaktivuje dotykový panel, abyste ho mohli vyčistit.	68	
Servis	Inicializace dálkového ovládání		Používá se k inicializaci vzdálené řídicí jednotky do stavu, v jakém byla po dodání z výroby.	70	
	Informace o dálkovém ovládání		Používá se k zobrazení názvu modelu, verze softwaru a sériového čísla vzdálené řídicí jednotky.	72	
Údržba	Informace o chybě		Používá se ke kontrole informací o chybě při výskytu chyby. <ul style="list-style-type: none"> • Lze zobrazit kód chyby, zdroj chyby, adresu chladiwa, model jednotky, výrobní číslo a kontaktní informace (telefonní číslo prodejce). * Aby bylo možné zobrazit model jednotky, výrobní číslo a kontaktní informace, tyto údaje se musí předem zaregistrovat.	74	
	Informace o filtru		Používá se ke kontrole stavu filtru. <ul style="list-style-type: none"> • Symbol filtru lze resetovat. 	78	

Procházení nabídkami

Procházení položkami nabídky Hlavní menu

Ovládání pomocí tlačítek

Vstup do nabídky Hlavní menu



Stiskněte tlačítko **[Nastavení]** na obrazovce Hlavní zobrazení.

Zobrazí se Hlavní menu.

Výběr položky



Stisknutím tlačítka **[F2]** přesuňte kurzor doleva.

Stisknutím tlačítka **[F3]** přesuňte kurzor doprava.

Kurzor

Nastavení funkcí

Vysoký výkon



Popis funkce

Funkce vysokého výkonu umožňuje jednotkám pracovat s vyšším než normálním výkonem, takže je možné rychle upravit teplotu vzduchu v místnosti na optimální hodnotu. Tato funkce bude probíhat až 30 minut a po uplynutí této doby nebo po dosažení předvolené pokojové teploty (podle toho, která podmínka bude splněna dříve) se jednotka vrátí do normálního provozního režimu. Jednotky se vrací k normálnímu provozu po změně pracovního režimu nebo rychlosti ventilátoru.

Ovládání pomocí tlačítek

1

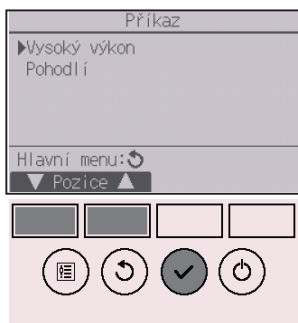

V režimu Chlazení, Vytápění nebo Auto vyberte „Vysoký výkon“ z nabídky Příkaz a stiskněte tlačítko **VYBRAT**.

Funkce „Vysoký výkon“ je k dispozici pouze pro ty modely, které ji podporují.

2



Tlačítkem **F3** nebo **F4** přesuňte kurzor na „Ano“ a stiskněte tlačítko **VYBRAT**.

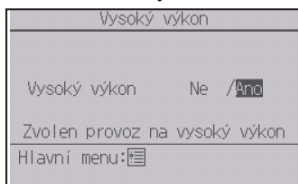

Zobrazí se potvrzovací obrazovka.

Procházení obrazovkami

- Přejít zpět do nabídky Hlavní menu tlačítko **MENU**
- Návrat na předchozí obrazovku tlačítko **NÁVRAT**

Nastavení funkcí

Ruční nastavení Žaluzie 1

OFF

Ovládání pomocí tlačítek

1



Vyberte „Pohodlí“ z nabídky Příkaz a stiskněte tlačítko **VYBRAT**.

2



Tlačítkem **F1** nebo **F2** vyberte „Ruční nastavení žal.1“ a stiskněte tlačítko **VYBRAT**.

3



Tlačítkem **F1** přesuňte kurzor na položku „Chl. adresa“ nebo „Č. jednotky“, kterou chcete vybrat. Tlačítkem **F2** nebo **F3** vyberte adresu chladiva a čísla těch jednotek, jejichž lopatky mají být pevně nastavené, a stiskněte tlačítko **VYBRAT**.

- Chl. adresa: Adresa chladiva
- Č. jednotky: 1, 2, 3, 4

Stisknutím tlačítka **F4** potvrďte jednotku.

Obrazovka na levé straně představuje příklad zobrazení na modelu Mr. SLIM. Na jednotkách CITY MULTI se místo „Chl. adresa“ zobrazuje „Adresa M-NET“ a nezobrazuje se „Č. jednotky“.

4



Tlačítkem **F1** vyberte „Žal. 1“.

Tlačítkem **F2** nebo **F3** vyberte „4cest.“ nebo „2cest.“ a stiskněte tlačítko **F4**.

Nastavení funkcí

5

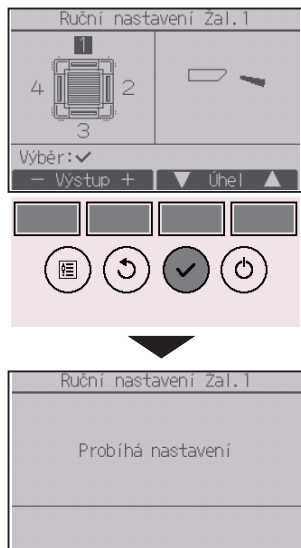

Zobrazí se aktuální nastavení Žal. 1.

Tlačítkem [F1] nebo [F2] vyberte požadované výstupy „1“, „2“, „3“, „4“ nebo „1, 2, 3, 4 (všechny výstupy)“.

Stisknutím tlačítka [F3] nebo [F4] procházejte následujícími možnostmi a vyberte požadované nastavení.

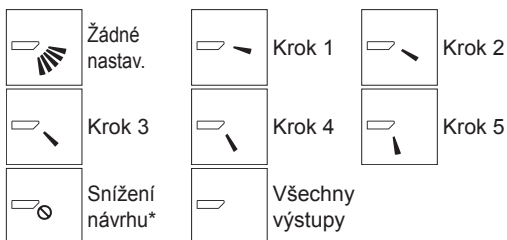

Stisknutím tlačítka [VYBRAT] uložte nastavení.

Zobrazí se obrazovka s oznámením, že probíhá přenos informací o nastavení.

Změny nastavení se provedou na vybraném výstupu.

Obrazovka se automaticky vrátí na předchozí obrazovku, jakmile se přenos dokončí.

Stejným postupem zadejte nastavení pro ostatní výstupy.

Pokud jsou vybrány všechny výstupy, při příštím spuštění jednotky se zobrazí .

Procházení obrazovkami

• Návrat na předchozí obrazovku tlačítko [NÁVRAT]

*Snížení návrhu

Režim [Snížení návrhu] zachová úhel lopatky spíše horizontálnější než úhel v nastavení Krok 1 a průtok vzduchu nebude směřován na lidi.

Tuto funkci lze nastavit pouze u jednoho výstupu.

Tuto funkci nelze nastavit u modelů se dvěma nebo třemi výstupy.

V režimu Snížení návrhu může průtok vzduchu způsobit zbarvení stropu.

Ovládání pomocí tlačítek

1

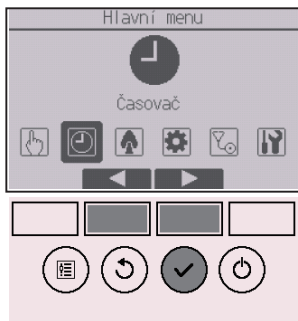

Z nabídky Hlavní menu (viz str. 24) vyberte „Časovač“ a stiskněte tlačítko **VYBRAT**.

Časovač zapnutí/vypnutí nebude fungovat v následujících případech:

když je časovač zapnutí/vypnutí deaktivován, při chybě, během kontroly (v servisní nabídce), během zkušebního chodu, během diagnostiky vzdálené řídicí jednotky, když nejsou nastavené hodiny, během nastavování funkcí, když je systém řízen centrálně (v tom případě je zakázáno zapínání/vypínání nebo ovládání časovače na místní vzdálení řídicí jednotce).

2

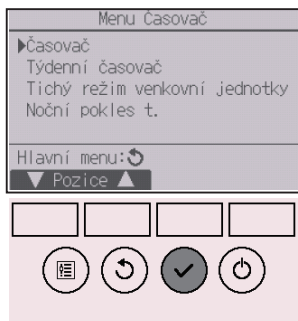

Přesuňte kurzor na „Časovač“ a stiskněte tlačítko **VYBRAT**.

3

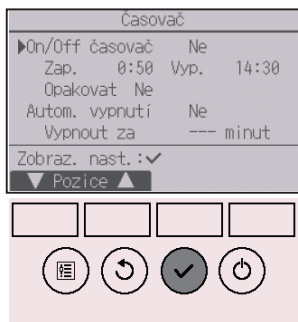

Zobrazí se aktuální nastavení.

Přesuňte kurzor na „On/Off časovač“ a stiskněte tlačítko **VYBRAT**.

Nastavení funkcí

4



Zobrazí se obrazovka pro nastavení časovače.

Tlačítkem **F1** nebo **F2** vyberte požadovanou položku „On/Off časovač“, „Zapnuto“, „Vypnuto“ nebo „Opakovat“.

5



Tlačítkem **F3** nebo **F4** změníte nastavení.

- On/Off časovač: Ne (deaktivovat)/Ano (aktivovat)
- Zapnuto: Čas spuštění provozu (nastavitelný v pětiminutových krocích)
 - * Chcete-li rychle měnit čísla, stiskněte a podržte tlačítko.
- Vypnuto: Čas zastavení provozu (nastavitelný v pětiminutových krocích)
 - * Chcete-li rychle měnit čísla, stiskněte a podržte tlačítko.
- Opakovat: Ne (jednou)/Ano (opakovat)

6



Stisknutím tlačítka **VYBRAT** uložíte nastavení.

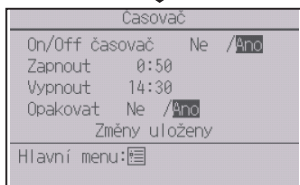



Zobrazí se potvrzovací obrazovka.

Procházení obrazovkami

- Přejít zpět do nabídky Hlavní menu tlačítko **MENU**
- Návrat na předchozí obrazovku tlačítko **NÁVRAT**



 se zobrazuje na obrazovkách Zobrazení stavu a Hlavní zobrazení v režimu Plné, když je aktivován On/Off časovač.

 se zobrazuje, když je časovač vypnut centrálně řízeným systémem.

Nastavení funkcí

Časovač (Časovač automatického vypnutí)



Ovládání pomocí tlačítek

1



Vyvolejte obrazovku nastavení Časovač.
(Viz str. 29.)

Vyberte „Autom. vypnutí“ a stiskněte tlačítko **VYBRAT**.

Časovač automatického vypnutí nebude fungovat v následujících případech:

když je časovač automatického vypnutí deaktivován, při chybě, během kontroly (v servisní nabídce), během zkušebního chodu, během diagnostiky vzdálené řídicí jednotky, během nastavování funkcí, když je systém řízen centrálně (v tom případě je zakázáno zapínání/vypínání nebo ovládání časovače na místní řídicí jednotce).

2



Zobrazí se aktuální nastavení.

Tlačítkem **F1** nebo **F2** přesuňte kurzor na „Autom. vypnutí“ nebo „Vypnout za --- minut“.

3



Tlačítkem **F3** nebo **F4** změňte nastavení.

- Autom. vypnutí: Ne (deaktivovat)/Ano (aktivovat)
- Vypnout za --- minut: Nastavení časovače (rozsah nastavení je 30 až 240 minut v desetiminutových krocích)

4



Stisknutím tlačítka **VYBRAT** uložte nastavení.

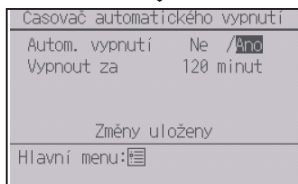



Zobrazí se potvrzovací obrazovka.

Procházení obrazovkami

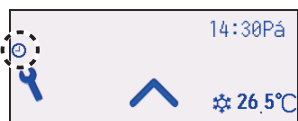
- Přejít zpět do nabídky Hlavní menu tlačítko **MENU**
- Návrat na předchozí obrazovku tlačítko **NÁVRAT**



 se zobrazuje na obrazovkách Zobrazení stavu a Hlavní zobrazení v režimu Plné, když je aktivován Časovač automatického vypnutí.

 se zobrazuje, když je časovač vypnut centrálně řízeným systémem.

Nastavení funkcí

Týdenní časovač



Ovládání pomocí tlačítek

1

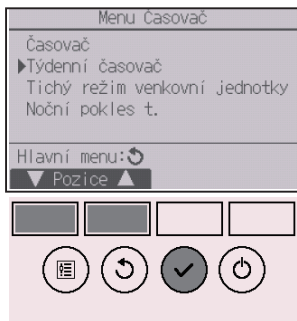

Vyberte „Týdenní časovač“ z nabídky Časovač a stiskněte tlačítko **VYBRAT**.

Týdenní časovač nebude fungovat v následujících případech:

když je aktivován časovač zapnutí/vypnutí, když je deaktivován týdenní časovač, při chybě, během kontroly (v servisní nabídce), během zkušebního chodu, během diagnostiky vzdálené řídicí jednotky, když nejsou nastavené hodiny, během nastavování funkcí, když je systém řízen centrálně (zapínání/vypínání, nastavování teploty nebo ovládání časovače z místní vzdálené řídicí jednotky je zakázáno).

2



Zobrazí se aktuální nastavení.

Stisknutím tlačítka **F1** nebo **F2** zobrazte nastavení pro každý den v týdnu.

Stisknutím tlačítka **F3** zobrazte vzory 5 až 8.

Stisknutím tlačítka **F4** zobrazte stav Nastavení 2.

Stisknutím tlačítka **VYBRAT** přejděte na obrazovku nastavení.

3



Zobrazí se obrazovka nastavení Týdenní časovač.

V nastavení „Akce“ pomocí tlačítka **F3** nebo **F4** vyberte „1“, abyste aktivovali nastavení časovače 1, nebo „2“, abyste aktivovali nastavení časovače 2. Poté stiskněte tlačítko **VYBRAT**.

Chcete-li zkontrolovat obsah nastavení časovače 1 nebo 2, tlačítkem **F1** nebo **F2** přesuňte kurzor na „Nastavení“ a tlačítkem **F3** nebo **F4** vyberte „1“ nebo „2“.

4



Zobrazí se obrazovka nastavení Týdenní časovač a aktuální nastavení.

Pro každý den lze nastavit až osm provozních vzorů. Tlačítkem **F1** nebo **F2** přesuňte kurzor na požadovaný den v týdnu a tlačítkem **F3** ho vyberte. (Lze vybrat více dnů.)

Stiskněte tlačítko **VYBRAT**.

Nastavení funkcí

5

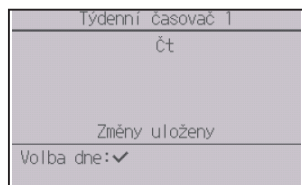

Zobrazí se obrazovka nastavení provozního vzoru. Tlačítkem **F1** přesuňte kurzor na číslo požadovaného vzoru.

Tlačítkem **F2** přesuňte kurzor na čas, položku Zap/Vyp nebo teplotu.

Tlačítkem **F3** nebo **F4** změňte nastavení.

- Čas: nastavitelný v pětiminutových krocích
 - * Chcete-li rychle měnit čísla, stiskněte a podržte tlačítko.
- Zap/Vyp/Auto: Volitelná nastavení závisí na modelu připojené vnitřní jednotky. (Jestliže je spuštěn vzor Auto, bude systém pracovat v režimu Auto (duální nastavení).)
- Teplota: Nastavitelný rozsah teplot závisí na připojených vnitřních jednotkách. (1°C přírůstek)
Jestliže je zvolen režim Auto (duální nastavení), mohou být zvoleny dvě předvolené teploty. Jestliže je spuštěn vzor s nastavením pro jednu předvolenou teplotu během režimu Auto (duální nastavení), jeho nastavení bude použito pro nastavení chladicí teploty v režimu Chlazení.

Stisknutím tlačítka **VYBRAT** uložte nastavení.

Zobrazí se potvrzovací obrazovka.

Procházení obrazovkami

- Přejít zpět na obrazovku změny nastavení/výběru dne v týdnu tlačítko **VYBRAT**
- Přejít zpět do nabídky Hlavní menu tlačítko **MENU**
- Návrat na předchozí obrazovku tlačítko **NÁVRAT**



7 se zobrazí na obrazovkách Zobrazení stavu a Hlavní zobrazení v režimu Plně, když existuje nastavení týdenního časovače pro aktuální den. Ikona se neobjeví, jestliže je aktivován On/Off časovač nebo je systém řízen centrálně (je zakázáno ovládání funkce Časovač z místní vzdálené řídicí jednotky).

Popis funkce

Tato funkce umožňuje uživateli nastavit časové intervaly, v nichž má tichý provoz venkovních jednotek přednost před regulací teploty. Nastavte časy spuštění a zastavení tichého provozu pro každý den v týdnu. Vyberte požadovanou úroveň tichého provozu „Střední“ nebo „Tichý“.

Ovládání pomocí tlačítek

1



Vyberte „Tichý režim venkovní jednotky“ z nabídky Časovač a stiskněte tlačítko **VYBRAT**.

Funkce „Tichý režim venkovní jednotky“ je k dispozici pouze pro ty modely, které ji podporují.

2



Zobrazí se aktuální nastavení.

Stisknutím tlačítka **F1** nebo **F2** zobrazte nastavení pro každý den v týdnu.

Stisknutím tlačítka **VYBRAT** přejděte na obrazovku nastavení.

Nastavení funkcí

3



Zobrazí se obrazovka pro aktivaci (Ano) a deaktivaci (Ne) tichého režimu.

Chcete-li aktivovat toto nastavení, tlačítkem **F3** nebo **F4** přesuňte kurzor na „Ano“ a stiskněte tlačítko **VYBRAT**.

4



Zobrazí se obrazovka nastavení Tichý režim venkovní jednotky.

Chcete-li provést nebo změnit nastavení, tlačítkem **F1** nebo **F2** přesuňte kurzor na požadovaný den v týdnu a tlačítkem **F3** ho vyberte. (Lze vybrat více dnů.)

Stiskněte tlačítko **VYBRAT**.

5

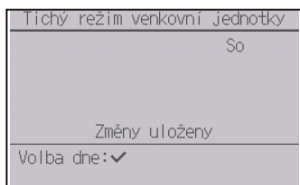

Zobrazí se obrazovka nastavení.

Tlačítkem **F1** nebo **F2** přesuňte kurzor na požadovanou položku odpovídající času Začátek, času Konec nebo úrovni Tichý.

Tlačítkem **F3** nebo **F4** změňte nastavení.

- Čas Začátek/Konec: nastavitelný v pětiminutových krocích
* Chcete-li rychle měnit čísla, stiskněte a podržte tlačítko.
- Úroveň Tichý: Normální, Střední, Tichý



Normální



Střední



Tichý

Stisknutím tlačítka **VYBRAT** uložte nastavení. Zobrazí se potvrzovací obrazovka.

Procházení obrazovkami

- Přejít zpět na obrazovku změny nastavení/výběru dne v týdnu tlačítko **VYBRAT**
- Přejít zpět do nabídky Hlavní menu tlačítko **MENU**
- Návrat na předchozí obrazovku tlačítko **NÁVRAT**



se zobrazuje na obrazovkách Zobrazení stavu a Hlavní zobrazení v režimu Plné, když je aktivován Tichý režim venkovní jednotky.

Nastavení funkcí

Noční pokles teploty



Popis funkce

Tento regulační prvek spouští vytápění, když je zastavena skupina regulační soustavy a pokojová teplota klesne pod předvolenou dolní mez. Také spouští chlazení, když je zastavena skupina regulační soustavy a pokojová teplota vzroste nad předvolenou horní mez.

Pokud se nastavování provozu a teploty provádí na vzdálené řídicí jednotce, funkce Noční pokles teploty není k dispozici.

Pokud je pokojová teplota měřena teplotním čidlem na vstupu klimatizační jednotky a tato jednotka je neaktivní nebo není čistý vzduch, naměřená teplota nemusí být přesná. V takovém případě přepněte snímání na vzdálené čidlo (PAC-SE40TSA/PAC-SE41TS-E) nebo na čidlo ve vzdálené řídicí jednotce.

Ovládání pomocí tlačítek

1



Vyberte „Noční pokles t.“ z nabídky Časovač a stiskněte tlačítko **VYBRAT**.

2



Zobrazí se aktuální nastavení.

Stisknutím tlačítka **VYBRAT** přejděte na obrazovku nastavení.

3

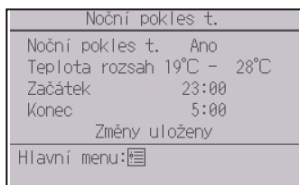

Tlačítkem **F1** nebo **F2** přesuňte kurzor na požadovanou položku Noční pokles teploty Ne (deaktivovat)/Ano (aktivovat), Teplotní rozsah, čas Začátek nebo čas Konec.

Tlačítkem **F3** nebo **F4** změňte nastavení.

- Teplotní rozsah: Lze nastavit dolní mez teploty (pro vytápění) a horní mez teploty (pro chlazení). Rozdíl teplot mezi dolní a horní mezí musí být 4°C (8°F) nebo vyšší. Nastavitelný rozsah teplot závisí na připojených vnitřních jednotkách.
* 1°C přírůstky
- Čas Začátek/Konec: nastavitelný v pětiminutových krocích
* Chcete-li rychle měnit čísla, stiskněte a podržte tlačítko.

Stisknutím tlačítka **VYBRAT** uložte nastavení.

Zobrazí se potvrzovací obrazovka.

Procházení obrazovkami

- Přejít zpět do nabídky Hlavní menu tlačítko **MENU**
- Návrat na předchozí obrazovku tlačítko **NAVRAT**

Nastavení funkcí



 se zobrazuje na obrazovkách Zobrazení stavu a Hlavní zobrazení v režimu Plné, když je aktivována funkce Noční pokles teploty.

 se zobrazuje, když je časovač vypnut centrálně řízeným systémem.

Noční pokles teploty nebude fungovat v následujících případech:

když je jednotka v provozu, když je deaktivována funkce nočního poklesu, při chybě, během kontroly (v servisní nabídce), během zkušebního chodu, během diagnostiky vzdálené řídicí jednotky, když nejsou nastavené hodiny, během nastavování funkcí, když je systém řízen centrálně (je zakázáno zapínání/vypínání systému, nastavování teploty nebo ovládání časovače na místní vzdálené řídicí jednotce).

Nastavení omezení rozsahu teplot

Ovládání pomocí tlačítek

1



Z nabídky Hlavní menu (viz str. 24) vyberte „Úspora energie“ a stiskněte tlačítko **VYBRAT**.

2



Tlačítkem **F1** nebo **F2** přesuňte kurzor na „Omezení“ a stiskněte tlačítko **VYBRAT**.

Nastavení funkcí

3



Zobrazí se aktuální nastavení.

Tlačítkem **F1** nebo **F2** přesuňte kurzor na „Teplotní rozsah“ a stiskněte tlačítko **VYBRAT**.

4



Zobrazí se obrazovka pro nastavení rozsahu teplot.

Tlačítkem **F1** přesuňte kurzor na požadovanou položku „Teplotní rozsah“, „Chl. -Odvlh.“ „Topení“ nebo „Auto“.

5

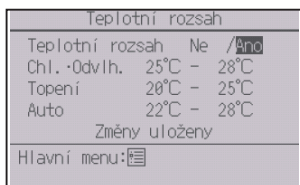

Tlačítkem **[F3]** nebo **[F4]** změňte nastavení.

- Teplotní rozsah: Ne (neomezený) nebo Ano (omezený)
- Chl.·Odvlh.: Horní a dolní mez teploty (1°C přírůsteky)
- Topení: Horní a dolní mez teploty (1°C přírůsteky)
- Auto: Horní a dolní mez teploty (1°C přírůsteky)

Rozsahy nastavení teplot

Režim	Dolní mez	Horní mez
Chlaz.·Odvlhč. *1 *3	19 ~ 30°C (67 ~ 87°F)	30 ~ 19°C (87 ~ 67°F)
Topení *2 *3	17 ~ 28°C (63 ~ 83°F)	28 ~ 17°C (83 ~ 63°F)
Auto *4	19 ~ 28°C (67 ~ 83°F)	28 ~ 19°C (83 ~ 67°F)

* Nastavitelný rozsah je závislý na připojené jednotce.

*1 Lze nastavit teplotní rozsah pro režimy Chlaz., Odvlhč. a Auto (duální nastavení).

*2 Lze nastavit teplotní rozsah pro režimy Topení a Auto (duální nastavení).

*3 Teplotní rozsahy pro režimy Topení, Chlaz. a Odvlhč. musí splňovat níže uvedené podmínky:

- Horní limit pro chlazení - horní limit pro topení \geq minimální teplotní rozdíl (liší se dle modelu vnitřní jednotky)
- Spodní limit pro chlazení - spodní limit pro topení \geq minimální teplotní rozdíl (liší se dle modelu vnitřní jednotky)

*4 Lze nastavit teplotní rozsah pro režim Auto (jednoduché nastavení).

Stisknutím tlačítka **[VYBRAT]** uložíte nastavení.

Zobrazí se potvrzovací obrazovka.

Procházení obrazovkami

- Přejít zpět do nabídky Hlavní menu tlačítko **[MENU]**
- Návrat na předchozí obrazovku tlačítko **[NÁVRAT]**



 se zobrazuje na obrazovkách Zobrazení stavu a Hlavní zobrazení v režimu Plně, když je teplotní rozsah omezen.

Nastavení funkcí

Omezení

P

Funkce blokování ovládání

Ovládání pomocí tlačítek

Chcete-li aktivovat funkci blokování, nastavte položku „Ovládání uzamčeno“ na „Ano“.

1



Vyvolejte obrazovku nastavení Omezení. (Viz str. 43.)

Přesuňte kurzor na „Ovládání uzamčeno“ a stiskněte tlačítko **VYBRAT**.

2

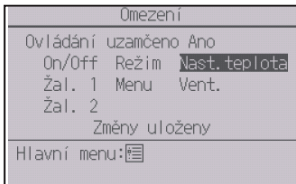

Zobrazí se obrazovka pro nastavení funkce blokování ovládání.

Tlačítkem **F1** nebo **F2** přesuňte kurzor na požadovanou položku „Ovládání uzamčeno“, „Místo“, „On/Off“, „Režim“, „Nast. teplota“, „Menu“, „Vent.“, „Žal. 2“ nebo „Žal. 1“.

Tlačítkem **F3** nebo **F4** změňte nastavení.

- Ovládání uzamčeno: Ne (deaktivovat)/Ano (aktivovat)
- Místo: „Jednot.“ nebo „Hotel“
- On/Off: Zapnutí/vypnutí
- Režim: Nastavení provozního režimu
- Nast. teplota: Nastavení předvolené teploty
- Žal. 1: Nastavení žaluzie 1
- Menu: Nastavení nabídky
- Vent.: Nastavení rychlosti ventilátoru
- Žal. 2: Nastavení žaluzie 2

Když je vybrána možnost „Hotel“ pro nastavení „Místo“, následující ovládání budou automaticky blokována: Režim, Žaluzie 1, Menu a Žaluzie 2.

Stisknutím tlačítka **VYBRAT** uložte nastavení. Zobrazí se potvrzovací obrazovka.

Procházení obrazovkami

- Přejít zpět do nabídky Hlavní menu tlačítko **MENU**
- Návrat na předchozí obrazovku tlačítko **NÁVRAT**

Nastavení funkcí



 se zobrazuje na obrazovkách Zobrazení stavu a Hlavní zobrazení v režimu Plné, když je aktivováno nastavení funkce blokování ovládání.

Popis ovládání odpovídající blokované funkci bude potlačen.

Chcete-li zobrazit Hlavní menu během uzamčení nabídky Nastavení, stiskněte tlačítko **Nastavení** a držte ho alespoň deset sekund. Na obrazovce pro zadání hesla zadejte Admin heslo.

Automatický návrat na předvolenou teplotu

Po aktivaci funkce Automatický návrat se provozní režim změní nebo se provede zapnutí/vypnutí provozu pomocí této vzdálené řídicí jednotky, nastavená teplota se automaticky vrátí na požadovanou teplotu bez ohledu na čas nastavení.

Ovládání pomocí tlačítek

1

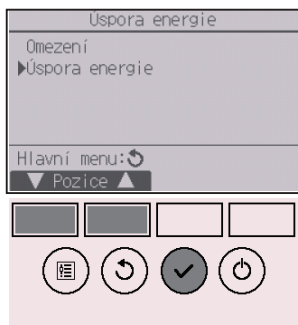

Vyberte „Úspora energie“ z nabídky Úspora energie a stiskněte tlačítko **VYBRAT**.

2

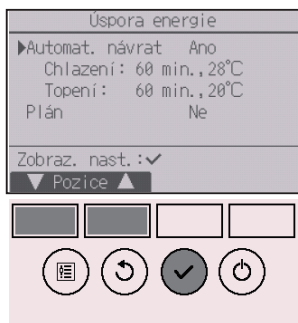

Zobrazí se aktuální nastavení.

Tlačítkem **F1** nebo **F2** přesuňte kurzor na „Automat. návrat“ a stiskněte tlačítko **VYBRAT**.

Nastavení funkcí

3



Zobrazí se obrazovka pro nastavení automatického návratu na předvolenou teplotu.

Tlačítkem **F1** nebo **F2** přesuňte kurzor na položku „Automat. návrat“, „Chlazení“ nebo „Topení“.

4



Tlačítkem **F3** nebo **F4** změňte nastavení.

- Automat. návrat: Ne (deaktivovat)/Ano (aktivovat)
- Chlazení: Rozsah nastavení časovače je 30 až 120 minut v desetiminutových krocích.
Rozsah nastavení teploty je 19 až 30°C (67 až 87°F) (1°C přírůstků).
- Topení: Rozsah nastavení časovače je 30 až 120 minut v desetiminutových krocích.
Rozsah nastavení teploty je 17 až 28°C (63 až 83°F) (1°C přírůstků).

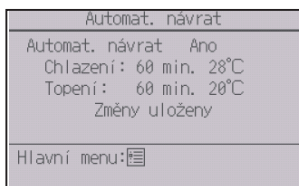

Stisknutím tlačítka **VYBRAT** uložte nastavení.

„Chlaz.“ zahrnuje režimy „Odvlhč.“ a „Autom. Chlaz.“ a „Topení“ zahrnuje režim „Autom. Topení“.
Zobrazí se obrazovka pro nastavení vybrané položky.

Procházení obrazovkami

- Přejít zpět do nabídky Hlavní menu tlačítko **MENU**
- Návrat na předchozí obrazovku tlačítko **NÁVRAT**

Nastavení časovače nebo předvolené teploty nebudou účinná, jestliže je rozsah teplot omezen a jestliže je systém centrálně řízen (pokud je nastavení rozsahu teplot na místní řídicí jednotce zakázáno). Jestliže je systém centrálně řízen (pokud je funkce nastavení časovače na místní vzdálené řídicí jednotce zakázána), bude neúčinné pouze nastavení časovače.

Nastavení časového rozvrhu úsporného provozu

Ovládání pomocí tlačítek

1

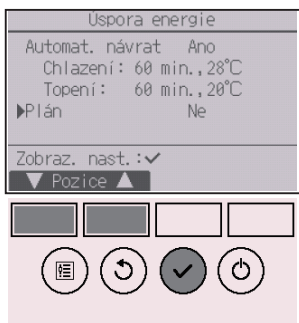

Vyvolejte obrazovku „Úspora energie“. (Viz str. 49.)

Přesuňte kurzor na „Plán“ a stiskněte tlačítko **VYBRAT**.

2



Zobrazí se obrazovka pro zobrazení časového rozvrhu.

Stisknutím tlačítka **F1** nebo **F2** zobrazte nastavení pro každý den v týdnu.

Stisknutím tlačítka **VYBRAT** přejděte na obrazovku nastavení.

3

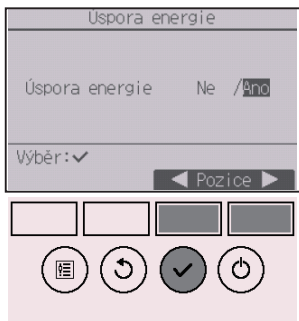

Zobrazí se obrazovka pro aktivaci (Ano)/deaktivaci (Ne) časového rozvrhu úsporného provozu.

Tlačítkem **F3** nebo **F4** vyberte „Ne“ nebo „Ano“.

Stisknutím tlačítka **VYBRAT** přejděte na obrazovku pro změnu nastavení/výběr dne v týdnu.

Nastavení funkcí

4



Zobrazí se obrazovka pro změnu nastavení/výběr dne v týdnu.

Pro každý den lze nastavit až čtyři provozní vzory. Tlačítkem **F1** nebo **F2** přesuňte kurzor na požadovaný den v týdnu a tlačítkem **F3** ho vyberte. (Lze vybrat více dnů.)

Stisknutím tlačítka **VYBRAT** přejděte na obrazovku nastavení vzoru.

5



Zobrazí se obrazovka nastavení vzoru.

Tlačítkem **F1** přesuňte kurzor na číslo požadovaného vzoru.

Tlačítkem **F2** přesuňte kurzor na požadovanou položku odpovídající času spuštění, času zastavení a míře úspory energie (zleva doprava v tomto pořadí).

Tlačítkem **F3** nebo **F4** změňte nastavení.

- Čas Začátek/Konec: nastavitelný v pětiminutových krocích
* Chcete-li rychle měnit čísla, stiskněte a podržte tlačítko.
- Míra úspory energie: Rozsah nastavení je 0% a 50 až 90% v desetiprocentních krocích.

Stisknutím tlačítka **VYBRAT** uložte nastavení.

Zobrazí se potvrzovací obrazovka.

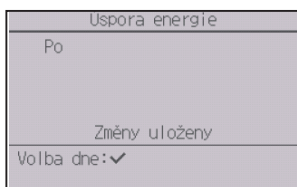

Čím nižší je hodnota, tím vyšší je účinek úspory energie.



 se zobrazí na obrazovkách Zobrazení stavu a Hlavní zobrazení v režimu Plné, když jednotka pracuje v úsporném režimu.

Procházení obrazovkami

- Přejít zpět na obrazovku změny nastavení/výběru dne v týdnu tlačítko **VYBRAT**
- Přejít zpět do nabídky Hlavní menu tlačítko **MENU**
- Návrat na předchozí obrazovku tlačítko **NÁVRAT**

Nastavení funkcí

Čas

P

Ovládání pomocí tlačítek

1



Z nabídky Hlavní menu (viz str. 24) vyberte „Úvodní nastavení“ a stiskněte tlačítko **VYBRAT**.

Hodiny se musí nastavit před nastavováním následujících parametrů.

- On/Off časovač
- Týdenní časovač
- Tichý režim venkovní jednotky
- Úspora energie
- Noční pokles teploty

Pokud nemá daný systém systémové ovladače, nebude čas na hodinách automaticky upraven. V tomto případě čas na hodinách pravidelně upravujte.

2



Tlačítkem **F1** nebo **F2** přesuňte kurzor na „Základní nastavení“ a stiskněte tlačítko **VYBRAT**.

3



Tlačítkem **F1** nebo **F2** vyberte „Čas“ a stiskněte tlačítko **VYBRAT**.

4



Tlačítkem **F1** nebo **F2** přesuňte kurzor na „Čas“ a stiskněte tlačítko **VYBRAT**.

5



Tlačítkem **F1** nebo **F2** přesuňte kurzor na požadovanou položku odpovídající roku, měsíci, datu, hodinám nebo minutám.

Tlačítkem **F3** nebo **F4** zvyšte nebo snižte hodnotu vybrané položky a stiskněte tlačítko **VYBRAT**. Zobrazí se potvrzovací obrazovka.

Procházení obrazovkami

- Přejít zpět do nabídky Hlavní menu tlačítko **MENU**
- Návrat na předchozí obrazovku tlačítko **NÁVRAT**

Nastavení funkcí

Letní čas



Popis funkce

U letního času lze nastavit čas začátku/konce. Funkce Letní čas bude aktivována na základě obsahu nastavení.

- Pokud má daný systém systémový ovladač, toto nastavení zakažte, aby byl zachován správný čas.
- Na začátku a konci letního času se může časovač spustit dvakrát, nebo se nemusí spustit vůbec.
- Tato funkce nebude fungovat, pokud nebyly nastaveny hodiny.

Ovládání pomocí tlačítek

1



Vyberte „Čas“ z nabídky Základní nastavení a stiskněte tlačítko **VYBRAT**.

2



Tlačítkem **F1** nebo **F2** přesuňte kurzor na „Letní čas“ a stiskněte tlačítko **VYBRAT**.

3



Tlačítkem **[F1]** přesuňte kurzor na následující položky a proveďte nastavení.

- **LČ**
Tlačítkem **[F2]** zvolte „Ne“ (zakázat) nebo „Ano“ (povolit). Výchozí nastavení je „Ne“.
- **Datum(Zač.)*1**
Tlačítkem **[F3]** nebo **[F4]** nastavte den v týdnu, číslo týdne a měsíc. Výchozí nastavení je „Ne/5./Bře“.
- **Čas začátku**
Tlačítkem **[F3]** nebo **[F4]** nastavte čas začátku letního času.
- **Dopředu k**
Tlačítkem **[F3]** nebo **[F4]** nastavte čas, kdy chcete hodiny nastavit dopředu k výše uvedenému času začátku.
- **Datum(Konec)*1 (2. strana)**
Tlačítkem **[F3]** nebo **[F4]** nastavte den v týdnu, číslo týdne a měsíc. Výchozí nastavení je „Ne/5./Říj“.
- **Čas konce (2. strana)**
Tlačítkem **[F3]** nebo **[F4]** nastavte čas konce letního času.
- **Zpět k (2. strana)**
Tlačítkem **[F3]** nebo **[F4]** nastavte čas, kdy chcete hodiny nastavit zpět k výše uvedenému času konce.

*1 Pokud pro číslo týdne zvolíte „5“ a 5. týden ve zvoleném měsíci v roce neexistuje, předpokládá se, že nastavení je „4“.

Stisknutím tlačítka **[VYBRAT]** uložte nastavení. Zobrazí se potvrzovací obrazovka.

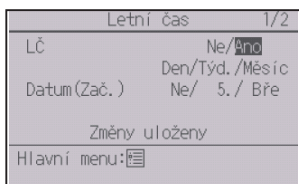

Procházení obrazovkami

- Přejít zpět do nabídky Hlavní menu tlačítko **[MENU]**
- Návrat na předchozí obrazovku tlačítko **[NÁVRAT]**

Nastavení funkcí

Hlavní zobrazení



Ovládání pomocí tlačítek

1



Vyberte „Nastavení displeje“ z nabídky Úvodní nastavení a stiskněte tlačítko **VYBRAT**.

2



Tlačítkem **F1** nebo **F2** přesuňte kurzor na „Hlavní zobrazení“ a stiskněte tlačítko **VYBRAT**.

3



Tlačítkem **F3** nebo **F4** vyberte „Plně“ nebo „Základní“ (viz str. 10) a stiskněte tlačítko **VYBRAT**.

Zobrazí se potvrzovací obrazovka.

Procházení obrazovkami

- Přejít zpět do nabídky Hlavní menu tlačítko **MENU**
- Návrat na předchozí obrazovku tlačítko **NÁVRAT**

Ovládání pomocí tlačítek

- 1 Vyberte „Nastavení displeje“ z nabídky Úvodní nastavení a stiskněte tlačítko **VYBRAT**.



Vyberte „Nastavení displeje“ z nabídky Úvodní nastavení a stiskněte tlačítko **VYBRAT**.

- 2 Tlačítkem **F1** nebo **F2** přesuňte kurzor na „Hlavní zobrazení“ a stiskněte tlačítko **VYBRAT**.



Tlačítkem **F1** nebo **F2** přesuňte kurzor na „Hlavní zobrazení“ a stiskněte tlačítko **VYBRAT**.

- 3 Tlačítkem **F1** nebo **F2** vyberte „Vysvětl. ikony“, tlačítkem **F3** nebo **F4** vyberte požadované nastavení „Ano“ nebo „Ne“ a stiskněte tlačítko **VYBRAT**. Výchozí nastavení je „Ano“.



Tlačítkem **F1** nebo **F2** vyberte „Vysvětl. ikony“, tlačítkem **F3** nebo **F4** vyberte požadované nastavení „Ano“ nebo „Ne“ a stiskněte tlačítko **VYBRAT**. Výchozí nastavení je „Ano“.

Procházení obrazovkami

- Přejít zpět do nabídky Hlavní menu tlačítko **MENU**
- Návrat na předchozí obrazovku tlačítko **NÁVRAT**

Nastavení funkcí

4



Když je zvolena možnost „Ano“, zobrazí se vysvětlení ikony určité položky nastavení, jak je znázorněno vlevo.

Ovládání pomocí tlačítek

1



Vyberte „Nastavení displeje“ z nabídky Úvodní nastavení a stiskněte tlačítko **VYBRAT**.

2



Tlačítkem **F1** nebo **F2** přesuňte kurzor na „Jas“ a stiskněte tlačítko **VYBRAT**.

3



Tlačítkem **F1** nebo **F2** nastavte jas.

Položku „Nezhasínat“ lze tlačítkem **F4** nastavit na „ZAP“ nebo „VYP“.

Při volbě „ZAP“ zůstane podsvícení tlumeně svítit i po uplynutí stanoveného času.

Procházení obrazovkami

- Přejít zpět do nabídky Hlavní menu tlačítko **MENU**
- Návrat na předchozí obrazovku tlačítko **NÁVRAT**

Nastavení funkcí

Volba jazyka



Popis funkce

Je možné nastavit požadovaný jazyk. Nabízejí se možnosti angličtina, francouzština, němčina, španělština, italština, portugalština, švédština, ruština, řečtina, turečtina, nizozemština, čeština, maďarština a polština.

Ovládání pomocí tlačítek

1



Vyberte „Nastavení displeje“ z nabídky Úvodní nastavení a stiskněte tlačítko **VYBRAT**.

2

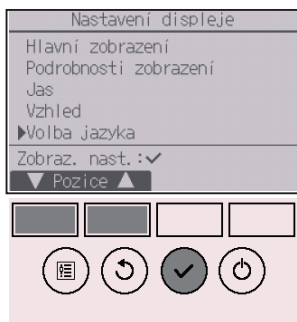

Tlačítkem **F1** nebo **F2** přesuňte kurzor na „Volba jazyka“ a stiskněte tlačítko **VYBRAT**.

3

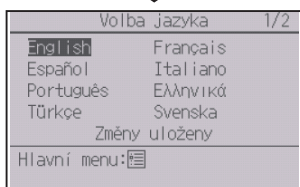

Tlačítka **F1** až **F4** přesuňte kurzor na požadovaný jazyk a stisknutím tlačítka **VYBRAT** uložte nastavení.

Při prvním spuštění se zobrazí obrazovka Volba jazyka. Vyberte požadovaný jazyk. Bez výběru jazyka se systém nespustí.

Zobrazí se obrazovka s oznámením, že nastavení bylo uloženo.

- Procházení obrazovkami**
- Přejít zpět do nabídky Hlavní menu tlačítko **MENU**
 - Návrat na předchozí obrazovku tlačítko **NÁVRAT**

Nastavení funkcí

Vzhled



Ovládání pomocí tlačítek

1



Vyberte „Nastavení displeje“ z nabídky Úvodní nastavení a stiskněte tlačítko **VYBRAT**.

2



Tlačítkem **F1** nebo **F2** přesuňte kurzor na „Vzhled“ a stiskněte tlačítko **VYBRAT**.

3



Tlačítkem **F4** vyberte „Barva“.

- Barva: Lze vybrat barvu zobrazení. (Viz další strana.)
- Bílá: Monochromatické zobrazení (bílý základ)
- Černá: Monochromatické zobrazení (černý základ)

Když je vybrána možnost „Bílá“ nebo „Černá“, stiskněte tlačítko **VYBRAT**. Když je vybrána „Barva“, vyberte požadovanou barvu podle následující strany.

4

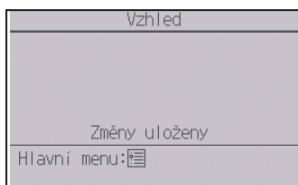

Tlačítkem **F1** nebo **F2** zvolte následující položku a pro každou z nich nastavte požadovanou barvu zobrazení.

- Odstín barvy: Tlačítkem **F3** nebo **F4** nastavte odstín barvy. (Rozsah nastavení je -90 až 89.)
- Vzor: Tlačítkem **F4** nastavte barvu.
- Bar. nast. na: Tlačítkem **F4** vyberte „Znak“ nebo „Pozadí“ jako cíl, pro který se má použít příslušná barva.

Ukázková barva pod funkčními tlačítky se bude měnit podle nastavení.

Vyberte požadovanou barvu a stiskněte tlačítko **VYBRÁT**.

Procházení obrazovkami

- Přejít zpět do nabídky Hlavní menu tlačítko **MENU**
- Návrat na předchozí obrazovku tlačítko **NÁVRAT**

Nastavení funkcí

Kalibrace dotykového panelu



Ovládání pomocí tlačítek

1



Vyberte „Dotykový panel“ z nabídky Úvodní nastavení a stiskněte tlačítko **VYBRAT**.

2



Tlačítkem **F1** nebo **F2** přesuňte kurzor na „Kalibrace dotyk. panelu“ a stiskněte tlačítko **VYBRAT**.

3



Zobrazí se potvrzovací obrazovka.

Tlačítkem **F3** nebo **F4** vyberte „Zrušit“ nebo „OK“ a stiskněte tlačítko **VYBRAT**.

4

Dotkněte se černých teček, aby se objevily na obrazovce. Celkem jich bude devět.

Za chvíli se černých teček dotýkejte dotykovým perem, začněte v levém horním rohu.

Dotkněte se devíti černých teček v pořadí, v jakém se objevují na obrazovce.

Až se dotknete všech devíti černých teček, kalibrace bude dokončena a zobrazení se vrátí na obrazovku Dotykový panel.

- Pokud se po dobu jedné minuty nedotknete dotykového panelu, kalibrace se zruší a zobrazení se automaticky vrátí na předchozí obrazovku.
- Ke správné kalibraci dotykového panelu je zapotřebí použít špičatý, ale nikoli ostrý předmět, kterým se budete dotýkat teček.
 - * Ostrý předmět by mohl poškodit nebo poškrábat dotykový panel.

Nastavení funkcí

Čištění dotykového panelu



Ovládání pomocí tlačítek

1



Vyberte „Dotykový panel“ z nabídky Úvodní nastavení a stiskněte tlačítko **VYBRAT**.

2

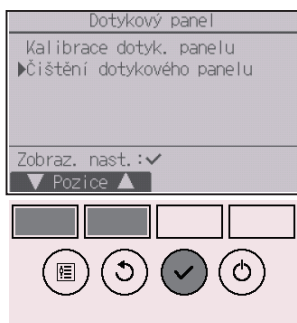

Tlačítkem **F1** nebo **F2** přesuňte kurzor na „Čištění dotykového panelu“ a stiskněte tlačítko **VYBRAT**.

3



Zobrazí se potvrzovací obrazovka.

Tlačítkem **F3** nebo **F4** vyberte „Zrušit“ nebo „OK“ a stiskněte tlačítko **VYBRAT**.

4



Tato obrazovka umožňuje uživateli otírat dotykový panel po dobu 30 sekund, aniž by došlo k neúmyslné změně nastavení.

Po 30 sekundách se zobrazení vrátí na nabídku Dotykový panel.

- K otírání použijte měkkou suchou látku, látku nasycenou vodou se slabým saponátem nebo látku navlhčenou lihem. Nepoužívejte kyselá, zásaditá ani organická rozpouštědla.

Nastavení funkcí

Inicializace dálkového ovládání



Popis funkce

Vzdálenou řídicí jednotku lze inicializovat do stavu, v jakém byla po dodání z výroby. Pamatujte, že budou inicializována následující data.

Vzdálená řídicí jednotka se po inicializaci automaticky spustí.

Nastavení Časovač, nastavení Týdenní časovač, nastavení Tichý režim venkovní jednotky, nastavení Úspora energie, nastavení možnosti Úspora energie, nastavení Čas, nastavení Letní čas, nastavení Hlavní zobrazení, nastavení Jas, nastavení Podrobnosti zobrazení, nastavení Vzhled, nastavení Automatický režim, nastavení Model, nastavení Výrobní číslo, nastavení Informace o prodejci, Informace o chybě, Admin heslo, Heslo pro údržbu

Ovládání pomocí tlačítek

1



Vyberte „Ostatní“ z nabídky Servis a stiskněte tlačítko **VYBRÁT**.

2



Tlačítkem **F1** nebo **F2** přesuňte kurzor na „Inicializace dálk. ovládání“ a stiskněte tlačítko **VYBRÁT**.

3

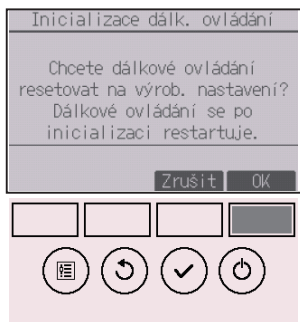

Tlačítkem **F4** vyberte „OK“.

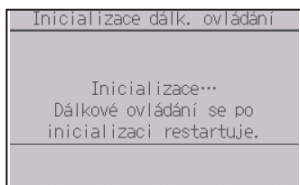

Vzdálená řídicí jednotka se po inicializaci automaticky spustí.

Nastavení funkcí

Informace o dálkovém ovládnání



Popis funkce

Lze zkontrolovat informace o používané vzdálené řídicí jednotce.

Ovládání pomocí tlačítek

1

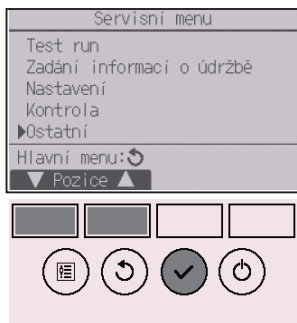

Vyberte „Ostatní“ z nabídky Servis a stiskněte tlačítko **VYBRAT**.

2



Tlačítkem **F1** nebo **F2** přesuňte kurzor na „Informace o dálk. ovládnání“ a stiskněte tlačítko **VYBRAT**.

3



Lze zkontrolovat údaje Model, S/W Ver a Výrobní číslo vzdálené řídicí jednotky.

Řešení problémů

Informace o chybě

Když dojde k chybě, zobrazí se následující obrazovka a bude blikat provozní kontrolka LED. Zkontrolujte stav chyby, zastavte systém a obraťte se na svého prodejce.

Ovládání pomocí tlačítek

1



Zobrazí se chybový kód, chyba jednotky, adresa chladiva, název modelu jednotky, datum a čas výskytu chyby a sériové číslo.

Název modelu a sériové číslo se zobrazí pouze v případě, že tyto údaje byly zaregistrovány.

Stisknutím tlačítka **F1** nebo **F2** přejděte na další stranu.

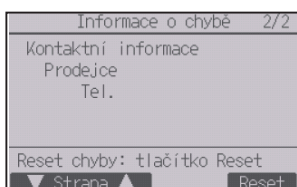

Zobrazí se Kontaktní informace (telefonní číslo prodejce), pokud byly zaregistrovány.

2



Stisknutím tlačítka **F4** nebo **ZAP/VYP** resetujte zjištěnou chybu.

Dokud je zakázáno zapínání/vypínání systému, chyby nelze resetovat.



Tlačítkem **F4** vyberte „OK“.



Zobrazí se potvrzovací obrazovka.

Procházení obrazovkami

- Přejít zpět do nabídky Hlavní menu tlačítko **MENU**

Řešení problémů

Kontrola informací o chybě



Dokud se neobjeví žádné chyby, stranu 2/2 informací o chybě (viz str. 74) lze zobrazit z nabídky. Vyberte „Menu Údržba“ z nabídky Hlavní menu a stiskněte tlačítko **VYBRAT**.

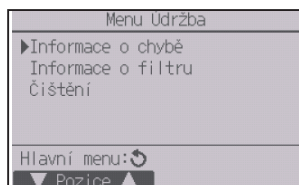

Chcete-li zobrazit obrazovku s informacemi o chybě, vyberte „Informace o chybě“ z nabídky Údržba. Chyby nelze resetovat.

Automatické vypnutí při nepřítomnosti

Následující obrazovka se zobrazí u modelu panelu 3D i-See sensor, je-li zařízení zastaveno pomocí funkce Auto VYP při nepřítomnosti pod položkou Úspora energie. Nastavení 3D i-See sensor naleznete v instrukční příručce k vnitřní jednotce.

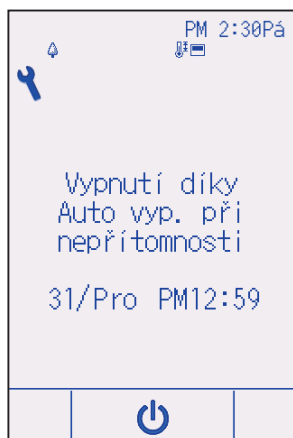

Údržba

Informace o filtru



 se zobrazuje na obrazovkách Zobrazení stavu a Hlavní zobrazení v režimu Plné, když nastane čas na vyčištění filtrů.

Když se zobrazí tento symbol, vyperte, vyčistěte nebo vyměňte filtry.

Podrobné pokyny najdete v instrukční příručce k vnitřní jednotce.

Ovládání pomocí tlačítek

1



Vyberte „Informace o filtru“ z nabídky Údržba a stiskněte tlačítko **VYBRAT**.

2



Stisknutím tlačítka **F4** resetujte symbol filtru. Pokyny pro čištění filtru najdete v instrukční příručce k vnitřní jednotce.

3



Tlačítkem **F4** vyberte „OK“.

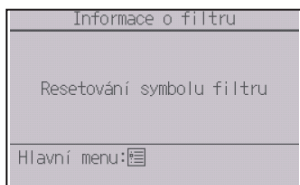

Zobrazí se potvrzovací obrazovka.

Procházení obrazovkami

- Přejít zpět do nabídky Hlavní menu tlačítko **MENU**
- Návrat na předchozí obrazovku tlačítko **NÁVRAT**



Když se na obrazovkách Zobrazení stavu a Hlavní zobrazení v režimu Plné zobrazí ikona , znamená to, že systém je řízen centrálně a nelze resetovat symbol filtru.

Pokud jsou připojené dvě nebo více vnitřních jednotek, časování čištění filtru v jednotlivých jednotkách se může lišit v závislosti na typu filtru.

Ikona  se zobrazí, až nastane čas na vyčištění filtru v hlavní jednotce.

Když se resetuje symbol filtru, resetuje se také souhrnná doba provozu všech jednotek.

Zobrazení ikony  je naplánováno po určité době provozu na základě předpokladu, že vnitřní jednotky jsou nainstalovány v prostoru s běžnou kvalitou vzduchu. Možná bude nutné čistit filtr častěji, záleží na kvalitě vzduchu.

Souhrnná doba, po které je nutné vyčistit filtr, je závislá na modelu.

Specifikace

Specifikace řídicí jednotky

	Specifikace
Velikost výrobku	Standard (PAR-CT01MAA(R)-SB/PAR-CT01MAA-S): 65 (Š) × 120 (V) × 14,1 (H) mm (2 9/16 × 4 23/32 × 9/16 [in]) (bez vyčnívající části)
	Premium (PAR-CT01MAA(R)-PB): 68 (Š) × 120 (V) × 14,1 (H) mm (2 11/16 × 4 23/32 × 9/16 [in]) (bez vyčnívající části)
Čistá hmotnost	Standard (PAR-CT01MAA(R)-SB/PAR-CT01MAA-S): 0,09 kg (13/64 lb)
	Premium (PAR-CT01MAA(R)-PB): 0,10 kg (7/32 lb)
Jmenovité napájecí napětí	12 V ss. (dodávané z vnitřních jednotek)
Příkon	0,6 W
Provozní prostředí	Teplota 0 ~ 40°C (32 ~ 104°F) Relativní vlhkost 25 ~ 90% (bez kondenzace)
Materiál	Standard (PAR-CT01MAA(R)-SB/PAR-CT01MAA-S) Hlavní část: ABS
	Premium (PAR-CT01MAA(R)-PB) Hlavní část: ABS Boční deska: Hliník

Seznam funkcí (k 1. říjnu 2017)

○ : Podporovaná × : Nepodporovaná

	Funkce	CITY MULTI	Mr. SLIM	Požadováno heslo
Napájení	Zapnutí/vypnutí napájení	○	○	-
Nastavení	Provozní režim	○	○	-
	Režim Auto (duální nastavení)	○	○	-
	Předvolená teplota	○	○	-
	Rychlost ventilátoru	○	○	-
	Žaluzie 1	○	○	-
	Žaluzie 2	○	○	-
	Rekuperace	○	○	-
Nabídka Příkaz	Vysoký výkon	×	○	-
	Ruční nastavení Žaluzie 1	○	○	-
	3D i-See sensor	○	○	-
Menu Časovač	Časovač (On/Off časovač)	○	○	správce
	Časovač (Časovač automatického vypnutí)	○	○	správce
	Týdenní časovač	○	○	správce
	Tichý režim venkovní jednotky	○	○	správce
	Noční pokles teploty	○	○	správce
Nabídka Úspora energie	Omezení Teplotního rozsahu	○	○	správce
	Funkce blokování ovládání	○	○	správce
	Automatický návrat	○	○	správce
	Plán	×	○	správce
Menu Úvodní nastavení	Čas	○	○	správce
	Nastavení formátu Zobrazení času	○	○	správce
	Letní čas	○	○	správce
	Hlavní zobrazení	○	○	správce
	Vysvětlení ikony	○	○	správce
	Jas	○	○	správce
	Volba jazyka	○	○	správce
	Vzhled	○	○	správce
	Kalibrace dotykového panelu	○	○	správce
	Čištění dotykového panelu	○	○	správce
Heslo (Admin)	○	○	správce	
Servisní menu	Inicializace dálkového ovládání	○	○	údržba
	Informace o dálkovém ovládání	○	○	údržba
	Test run	○	○	údržba
	Zadání Informací o modelu	○	○	údržba
	Zadání Informací o prodejci	○	○	údržba
	Nastavení funkcí	○	○	údržba
	Nenáročná údržba	×	○	údržba
	Heslo (Údržba)	○	○	údržba
Menu Údržba	Auto-spouštění filtru	○	○	-
	Informace o chybě	○	○	-
	Informace o filtru	○	○	-

* Podporované funkce se liší podle modelu jednotky.

Specifikace

Seznam funkcí, které lze/nelze používat současně

	Vysoký výkon	On/Off časovač	Časovač automatického vypnutí	Týdenní časovač	Tichý režim venkovní jednotky	Teplotní rozsah	Ovládání uzamčeno	Automatický návrat	Plán úspory energie	Noční pokles teploty
Vysoký výkon		○	○	○	△ 1	○	△ 2	○	△ 1	○
On/Off časovač	○		○	× 1	○	○	○	○	○	△ 3
Časovač automatického vypnutí	○	○		○	○	○	○	○	○	△ 4
Týdenní časovač	○	× 1	○		○	○	○	○	○	△ 5
Tichý režim venkovní jednotky	△ 1	○	○	○		○	○	○	○	○
Teplotní rozsah	○	○	○	○	○		○	× 2	○	△ 6
Ovládání uzamčeno	△ 2	○	○	○	○	○		○	○	○
Automatický návrat	○	○	○	○	○	× 2	○		○	△ 7
Plán úspory energie	△ 1	○	○	○	○	○	○	○		○
Noční pokles teploty	○	△ 3	△ 4	△ 5	○	△ 6	○	△ 7	○	

○ : Lze používat současně × : Nelze používat současně △ : Omezený

△ 1: Tato funkce se aktivuje po skončení provozu s vysokým výkonem, protože ten má vyšší prioritu.

△ 2: Tuto funkci nelze použít, pokud je blokováno nějaké ovládání.

△ 3: Funkci Noční pokles teploty nelze použít, když je jednotka řízena nastavením On/Off časovač.

△ 4: Funkci Automatické vypnutí nelze použít k provozu s funkcí Noční pokles teploty.

△ 5: Funkci Noční pokles teploty nelze použít, když jednotka je jednotka řízena nastavením Týdenní časovač.

△ 6: Nastavení Teplotní rozsah nelze použít k provozu s funkcí Noční pokles teploty.

△ 7: Funkci Automatický návrat nelze použít k provozu s funkcí Noční pokles teploty.

× 1: Nastavení Týdenní časovač je neúčinné, protože On/Off časovač má vyšší prioritu.

× 2: Funkci Automatický návrat nelze použít, protože nastavení Teplotní rozsah má vyšší prioritu.

CITY MULTI vezérlőrendszer
és Mitsubishi Mr. SLIM Air légkondicionáló berendezések

MA érintős távvezérlő

PAR-CT01MAA-PB

PAR-CT01MAA-SB

PAR-CT01MAA-S

PAR-CT01MAR-PB

PAR-CT01MAR-SB

Használati útmutató

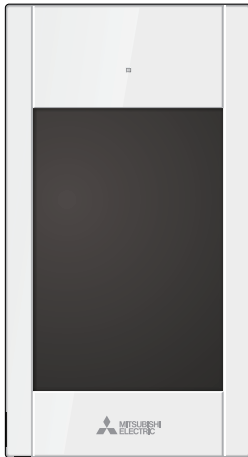

Magyar

Használat előtt, gondosan olvassa el jelen útmutató utasításait a termék megfelelő használata érdekében.

Őrizze meg jövőbeli referencia céljából.

Gondoskodjon róla, hogy ezt a CD-ROM-ot és a telepítési kézikönyvet átadja majd bármely jövőbeli felhasználónak.



A távvezérlő biztonságos és megfelelő üzemeltetése érdekében a távirányítót csak szakképzett személyzet telepítheti.

Tartalomjegyzék

Biztonsági óvintézkedések	4
A vezérlő elemei	6
Vezérlőfelület – állapotkijelző/fő kijelző	6
Vezérlőfelület – menü képernyő	8
Kijelző – állapotkijelző/fő kijelző	10
A menü szerkezete és ikonja	12
Menüszerkezet	12
Ikonok magyarázata	15
Alapvető műveletek	16
Teljesítmény BE/KI	16
Üzem mód, hőmérséklet, ventilátorsebesség, terelő, zsalu és ventiláció (Lossnay) beállításai	17
Navigálás a menüben	22
Fő menü listája	22
Navigálás a fő menüben	24
Funkcióbeállítások	25
Nagy teljesítmény	25
Terelőlap manuális szöge	26
Időzítő (Időzítő be/ki)	29
Időzítő (Auto kikapcsolás időzítő)	32
Heti időzítő	34
Kültéri egység halk üzem mód	37
Éjszakai csökkentett üzem mód	40
Korlátozás	43
Energiatakarékos	49
Óra	54
Nyári időszámítás	56
Fő kijelző	58
Ikonok magyarázata	59
Fényerő	61
Nyelvválasztás	62
Megjelenés	64
Érintőpanel kalibrálása	66
Érintőpanel tisztítása	68
Távírányító alaphelyzetbe állítása	70
Távírányító adatok	72
Hibaelhárítás	74
Hibainformációk	74
Nem használt szoba Auto Ki	77
Karbantartás	78
Szűrőinformációk	78
Műszaki adatok	80
Vezérlő műszaki adatai	80
Funkciólista (2017. október 1-től érvényes)	81
Az összes kombinálható/nem lehet kombinálható funkció listája ..	82

Biztonsági óvintézkedések

- Alaposan olvassa el ezeket a biztonsági óvintézkedéseket az egység használata előtt.
- A készülék biztonságos üzemeltetése érdekében kövesse az utasításokat.

 FIGYELMEZTETÉS	Súlyos sérülés vagy halálos baleset veszélyét jelzi.
 VIGYÁZAT	Súlyos sérülés vagy szerkezeti károsodás veszélyét jelzi.

- Ha elolvasta a kézikönyvet, adja azt tovább a végfelhasználónak későbbi hivatkozás céljából.
- Őrizze meg a kézikönyvet és szükség esetén tanulmányozza azt. A kézikönyvet elérhetővé kell tenni azok számára, akik a vezérlőt javítják vagy új helyre szerelik fel. A kézikönyvet minden későbbi felhasználó számára elérhetővé kell tenni.

Általános óvintézkedések

FIGYELMEZTETÉS

A berendezést tilos olyan helyre szerelni, ahol nagyobb mennyiségben található olaj, gőz, szerves oldószer vagy maró hatású gázok (pl. kénes gáz), illetve ahol gyakran használnak savas/lúgos oldatokat vagy sprayt. Ezek az anyagok károsíthatják a berendezés működését, illetve a berendezés egyes elemeinek korrodálódását okozhatják és ez áramütés, meghibásodás, füst vagy tűz veszélyével járhat.

Rövidzárlat, áramszivárgás, áramütés, meghibásodás, füst vagy tűz kockázatának csökkentése érdekében a vezérlőt ne mossa le vízzel vagy más folyadékkal.

Áramütés, meghibásodás, füst vagy tűz kockázatának csökkentése érdekében ne nyúljon nedves kézzel a vezérlő kapcsolóihoz és gombjaihoz vagy egyéb elektromos részekhez.

Amikor a készüléket alkohollal fertőtleníti, szellőztesse a helyiséget megfelelően. Az alkohol gőzei az egység körül tüzet vagy robbanást okozhatnak az egység bekapcsolásakor.

Az áramütés kockázatának csökkentése érdekében állítsa le a vezérlő működését és takarja le a készüléket, ha a vezérlő körül bármilyen vegyi anyagot kíván permetezni.

Az áramütés kockázatának csökkentése érdekében állítsa le a vezérlő működését és takarja le a készüléket, ha a vezérlőt tisztítja, ellenőrzi vagy karbantartást végez.

Amennyiben bármilyen rendellenességet (pl. égésszag) észlel, állítsa le az üzemeltetést, kapcsolja le a főkapcsolót és konzultáljon kereskedőjével. Amennyiben folytatja a termék használatát, az elektromos áramütéshez, meghibásodásokhoz, vagy tüzesethez vezethet.

Helyezze fel megfelelően az összes fedelet, hogy a vezérlőbe ne hatolhasson be por és nedvesség. Por felgyülemlése és nedvesség behatolása áramütést, füstöt vagy tüzet okozhat.

VIGYÁZAT

A tűz vagy robbanás kockázatát csökkentheti, ha nem helyez gyúlékony anyagokat és nem használ gyúlékony sprayt a vezérlő közelében.

A vezérlő sérülésének elkerülése érdekében, ne permetezzen rovarirtószert vagy más gyúlékony anyagot közvetlenül a vezérlőre.

A környezetszennyezés kockázatának csökkentése érdekében, keressen fel egy meghatalmazott ügynökséget a távvezérlő megfelelő ártalmatlanítása érdekében.

Áramütés és meghibásodás kockázatának csökkentése érdekében ne érintsen hegyes vagy éles tárgyat a vezérlőpanelhez, a kapcsolókhoz és gombokhoz.

Sérülés és áramütés veszélyének csökkentése érdekében ne nyúljon a vezérlőelemek éles részeihez.

A sérülési kockázatok csökkentése érdekében a vezérlőn való munka során viseljen megfelelő védőfelszerelést.

Üvegtörmelék által okozott sérülés elkerülése érdekében ne alkalmazzon túlzott nyomást az üvegből készült részeken.

Óvintézkedések a távvezérlő áthelyezése vagy javítása esetén

FIGYELMEZTETÉS

A vezérlő javítását, illetve áthelyezését képzett személynek kell végeznie. Ne szerelje szét és ne módosítsa a vezérlőt.

A nem megfelelő telepítés vagy javítás sérülést, áramütést vagy tűz keletkezését okozhatja.

VIGYÁZAT

Rövidzárlat, áramütés, tűz vagy meghibásodás kockázatának csökkentése érdekében ne érjen az áramkörhöz szerszámmal vagy szabad kézzel és ne hagyja, hogy por gyűljön az áramkörre.

További óvintézkedések

A vezérlő sérülésének elkerülése érdekében, a telepítéshez, ellenőrzéshez vagy javításhoz használjon megfelelő szerszámokat.

A vezérlő kizárólag a Mitsubishi Electric Building Management System (Mitsubishi Electric épületvezérlő rendszerek) rendszerrel történő használatra lett tervezve. Ha a vezérlőt más rendszerekkel vagy más célra használja, meghibásodást okozhat.

A készülék nem alkalmas csökkent fizikai, érzékszervi vagy mentális képességekkel, vagy nem megfelelő tapasztalattal és ismeretekkel rendelkező személyek általi használatra (beleértve a gyermekeket is), kivéve, ha felügyeletben és útmutatásban részesülnek a készülék használatát illetően egy, a biztonságukért felelős személy részéről.

A gyermekek felügyelet alatt tartandók, hogy ne játszhassanak a készülékkel.

Az elszíneződések elkerülése érdekében ne használjon benzolt, higítót vagy vegyszerrel átitatott törölkendőt a vezérlő tisztításához. A tisztításhoz használjon egy enyhe mosószeres vízzel átitatott ruhát, majd egy megnedvesített ruhával törölje le a mosószert, végül egy száraz ruhával törölje át a felületet.

A vezérlő károsodásának elkerülése érdekében biztosítsa a sztatikus elektromosság elleni védelmet.

A készüléket szakavatott vagy képzett személyek műhelyekben, a könnyűipari alkalmazásokban és gazdálkodásokban is használhatják, laikus személyek viszont kizárólag kereskedelmi célra használhatják.

Ha a tápkábel megsérül, a fennálló balesetveszély miatt a cseréjét kizárólag a gyártó, a márkaszerviz munkatársa vagy hasonlóan szakképzett személy végezheti.

A vezérlő elemei

Vezérlőfelület – állapotkijelző/fő kijelző

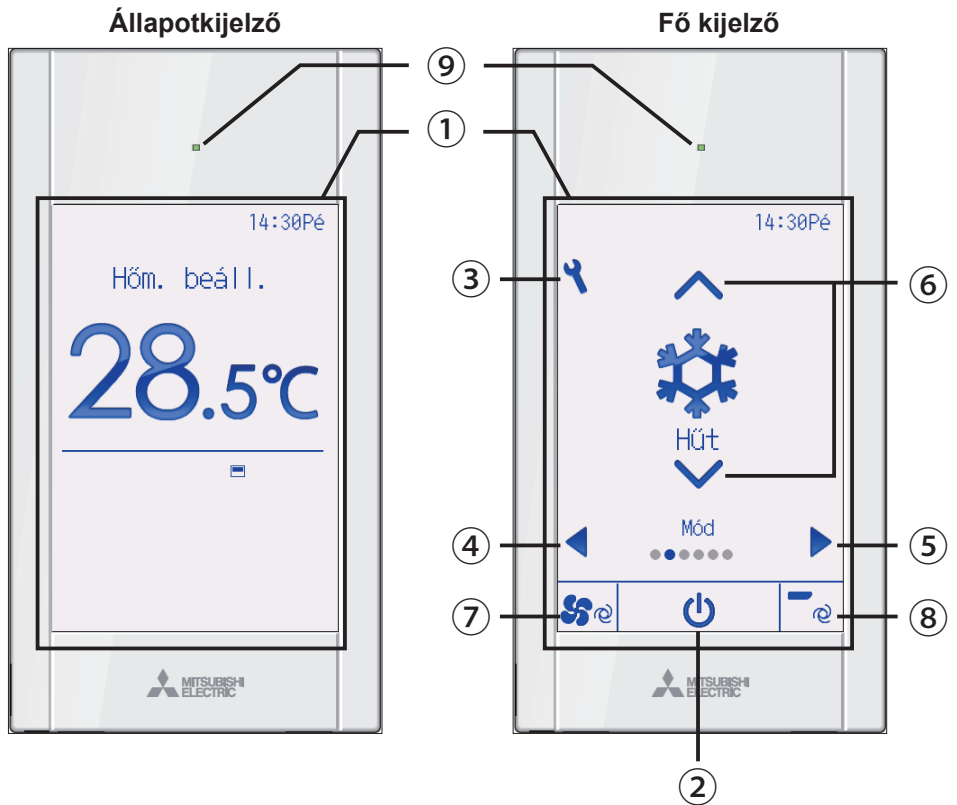

① Érintőpanel és háttér-világítású színes LCD

Megjelennek az üzemi beállítások. Ha a háttérfény ki van kapcsolva, a képernyő bármely terület megnyomásakor az állapotkijelzőre vált. Ha képernyőn az állapotkijelző látható, a képernyő bármely terület megnyomásakor a fő kijelzőre vált.

② **BE/KI** gomb

Nyomja meg a beltéri egység BE/KI kapcsolásához.

③ **Beállítás** gomb

Nyomja meg a fő menü előhívásához. Ha a menüműveletek le vannak zárva, adminisztrátori jelszóra van szükség.

④ **◀** gomb

Megnyomásával a beállítási pontok az alábbi sorrendben változnak: zsalu, ventiláció, terelő, ventilátorsebesség, üzemmód és előre beállított hőmérséklet.

⑤ **▶** gomb

Megnyomásával a beállítási pontok az alábbi sorrendben változnak: előre beállított hőmérséklet, üzemmód, ventilátorsebesség, terelő, ventiláció és zsalu.

⑥ **▲ ▼** gomb

Megnyomásával a ④ és ⑤ gombokkal kiválasztott beállítások értékének változtathatók.

⑦ Ventilátorsebesség gyorsgombja

Megnyomásával a ventilátorsebesség beállítási képernyője közvetlen elérhető.

⑧ Terelő gyorsgombja

Megnyomásával a terelő beállítási képernyője közvetlen elérhető.

⑨ **BE/KI** lámpa

A lámpa zölden világít, amikor az egység üzemel, kivéve ha a „LED világítás” beállítása „Nem”. Villog, amíg a távvezérlő elindítási folyamata tart vagy hiba esetén.

Ha a be/ki művelet le van zárva, a ② nem jelenik meg.

A beállítási pontok közötti, ④ vagy ⑤ gombokkal történő váltáskor, ha a kiválasztott beállítás művelete le van zárva, a beállítási pont nem jelenik meg.

Ha a ventilátorsebesség vagy a terelő művelete le van zárva, a ⑦ vagy ⑧ elemek nem jelennek meg.

A beállítási tartalom ⑥ gombbal nem változtatható, ha a rendszervezérlő a beállítási pontokat központilag vezérli.

A vezérlő elemei

Vezérlőfelület – menü képernyő



① **BE/KI** gomb

Nyomja meg a beltéri egység BE/KI kapcsolásához.

② **VÁLASZT** gomb

Nyomja meg a beállítás mentéséhez.

③ **VISSZA** gomb

Nyomja meg az előző képernyőre való visszatéréshez.

Ha a képernyőn a fő menü látható, a gomb megnyomásával az állapotkijelző jelenik meg.

④ **MENÜ** gomb 24. oldal

Nyomja meg a fő menü előhívásához.

⑤ **Funkciógomb** **F1**

Menü képernyő: a gomb funkciója képernyőnként változik.

⑥ **Funkciógomb** **F2**

Fő menü: nyomja meg a kurzor balra mozgatásához.

Menü képernyő: a gomb funkciója képernyőnként változik.

⑦ **Funkciógomb** **F3**

Fő menü: nyomja meg a kurzor jobbra mozgatásához.

Menü képernyő: a gomb funkciója képernyőnként változik.

⑧ **Funkciógomb** **F4**

Menü képernyő: a gomb funkciója képernyőnként változik.

A funkció gombok funkciói a képernyő függvényében változnak. Mindig az LCD alján megjelenő gomb funkció útmutatót kövesse, mivel az épp aktuális funkció az adott képernyőn jelenik meg.

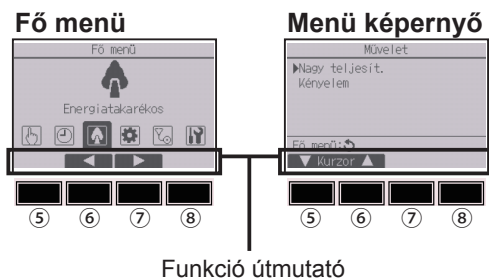

A vezérlő elemei

Kijelző – állapotkijelző/fő kijelző

Az állapotkijelző és a fő kijelző két különböző módon jeleníthető meg: „Teljes” és „Alap”.

A gyári beállítás a „Teljes”. A mód váltását lásd az 58. oldalon.

Teljes mód

* Minden ikon megjelenik magyarázat végett.

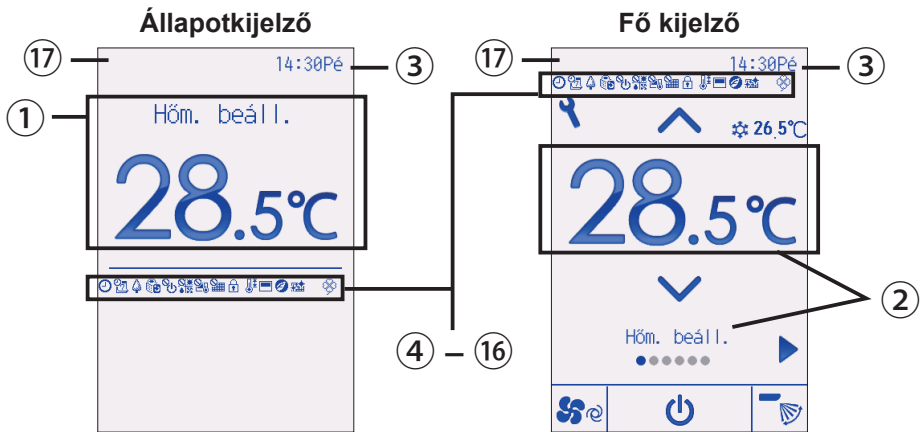

Alap mód

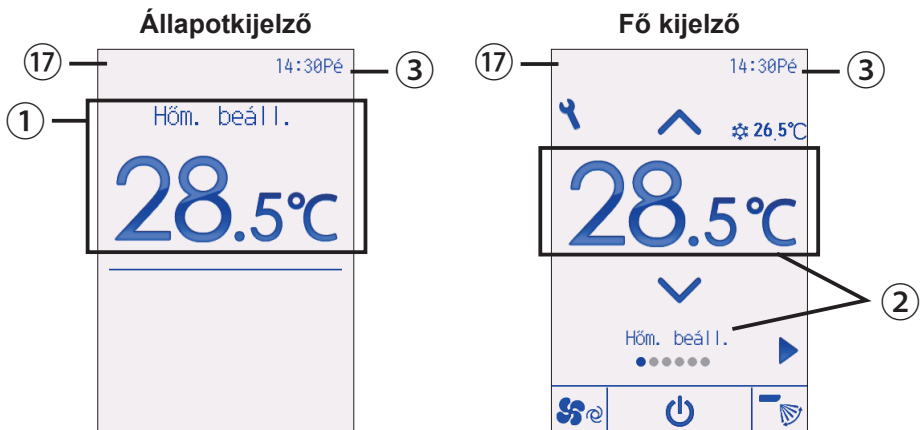

① Előre beállított hőmérséklet vagy a szoba hőmérséklete

Az előre beállított hőmérséklet vagy a szoba hőmérséklete itt jelenik meg. (Lásd a telepítési kézikönyvet.)

② Beállítási pont és beállítási tartalom 17. oldal

Itt jelennek meg az „Előre beállított hőmérséklet” ↔ „Üzem mód” ↔ „Ventilátor sebesség” ↔ „Terelő” ↔ „Ventiláció” ↔ „Zsalu” beállítási pontok és beállítás tartalmaik.

A „Központi vezérlés” megjelenik egy bizonyos ideig, amikor egy központi vezérlésű elem kezelése történik.

③ Óra

Az aktuális idő jelenik meg itt. (Lásd a telepítési kézikönyvet.)

④ 29., 32., 40. oldal

Akkor jelenik meg, amikor az „Időzítő be/ki” (29. oldal), az „Éjszakai csökkentett” (40. oldal) vagy az „Auto kikapcsolás időzítő” (32. oldal) funkció engedélyezve van.

 jelenik meg, ha a központi vezérlő rendszerben az időzítő nincs engedélyezve.

⑤ 34. oldal

Akkor jelenik meg, amikor a Heti időzítő engedélyezve van.

⑥ 51. oldal

Megjelenik, miközben az egységek energiatakarékos üzemmódban üzemelnek. (Némelyik típusú beltéri egységeken nem jelenik meg)

⑦ 37. oldal

Megjelenik, miközben a kültéri egységek csendes üzemmódban üzemelnek.

⑧

Megjelenik, amikor a BE/KI üzem központilag vezérelt.

⑨

Akkor jelenik meg, amikor az üzemmód központilag vezérelt.

⑩

Akkor jelenik meg, amikor az előre beállított hőmérséklet központilag vezérelt.

⑪

Akkor jelenik meg, amikor a szűrő visszaállítás funkció központilag vezérelt.

⑫ 46. oldal

Megjelenik, amikor a gombok zárolva vannak.

⑬ 43. oldal

Akkor jelenik meg, amikor az előre beállított hőmérséklet tartomány korlátozott.

⑭

Akkor jelenik meg, amikor a beépített termosztor a távvezérlőn aktiválva van a helyiség hőmérsékletének nyomon követésére.

 megjelenik, ha a termosztor a beltéri egységen aktiválva van a helyiség hőmérsékletének nyomon követésére.

⑮

Akkor jelenik meg, ha egy energiatakarékosági művelet kerül végrehajtásra egy „3D i-See sensor” funkció használatával.

⑯ 78. oldal

Jelzi, mikor van szükség a szűrő karbantartására.

⑰ Előzetes hibakijelzés

Az előzetes hiba során egy hibakód jelenik meg.

A menü szerkezete és ikonja

Menüszerkezet

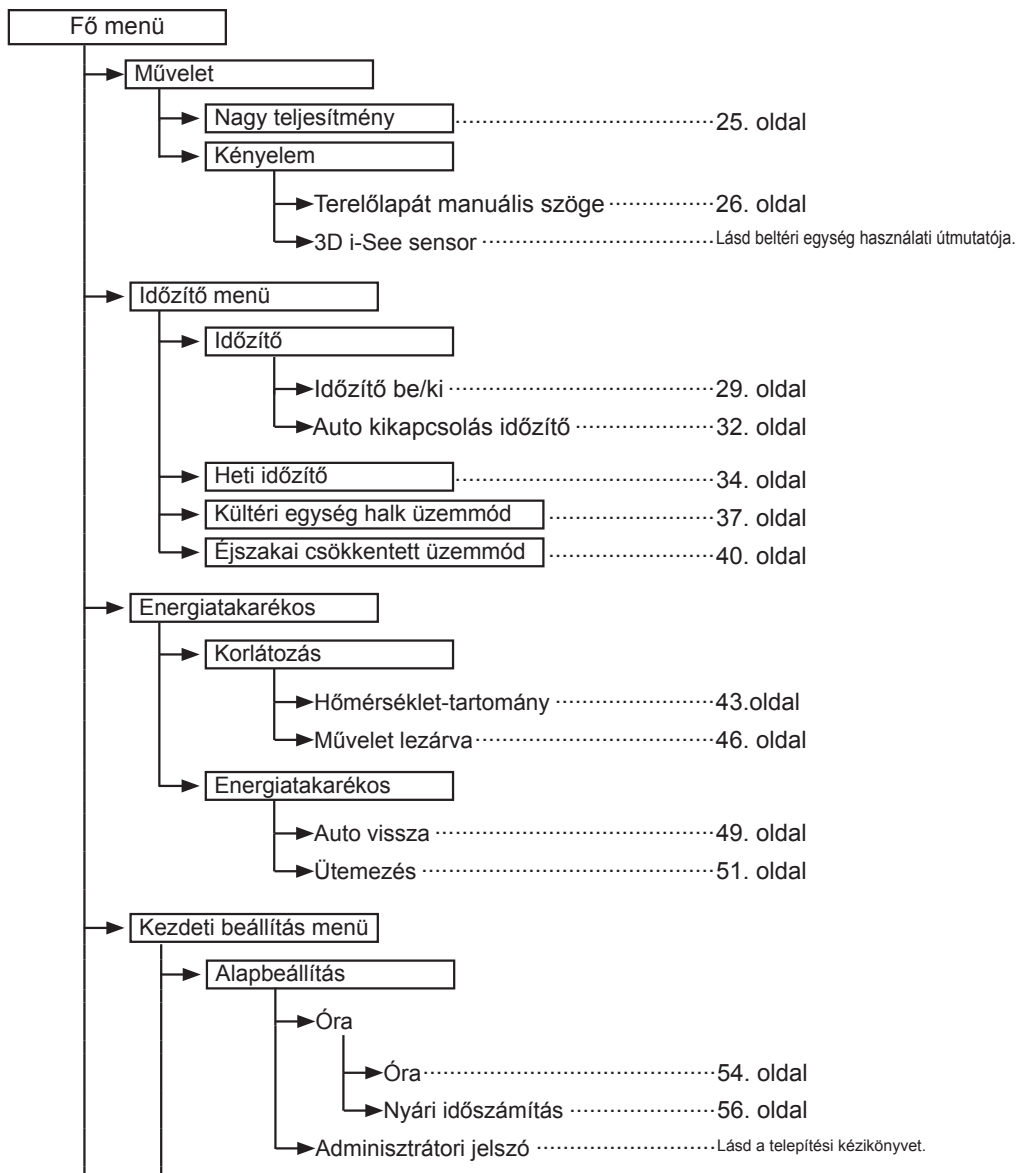

→	Kijelzési beállítás	
	→ Fő kijelző	58. oldal
	→ Kijelző részletei (ikonok magyarázata stb.) ...	Lásd a telepítési kézikönyvet.
	→ Fényerő	61. oldal
	→ Nyelvválasztás	62. oldal
	→ Megjelenés	64. oldal
	Műveleti beállítás	
	→ Auto üzemmód	Lásd a telepítési kézikönyvet.
	Érintőpanel	66. oldal
→	Karbantartás menü	
	→ Hibainformációk	74. oldal
	→ Szűrőinformációk	78. oldal
	→ Tisztítás	
	→ Auto terelőlemez	Lásd az automatikus emelőlemezhez mellékelt használati útmutatót.
	→ Terelőművelet	Lásd az automatikus emelőlemezhez mellékelt használati útmutatót.
	→ Terelőbeállítás	Lásd az automatikus emelőlemezhez mellékelt használati útmutatót.
→	Szerviz menü	
	→ Próbaüzem menü	
	→ Próbaüzem	Lásd a beltéri egység telepítési kézikönyvét.
	→ Üritőszivattyú próbaüzeme	Lásd a beltéri egység telepítési kézikönyvét.
	→ Karbantartási adatok	Lásd a beltéri egység telepítési kézikönyvét.
	→ Modellnév bevitele	Lásd a beltéri egység telepítési kézikönyvét.
	→ Sorozatszám bevitele	Lásd a beltéri egység telepítési kézikönyvét.
	→ Kereskedői adatok bevitele	Lásd a beltéri egység telepítési kézikönyvét.
	→ Karbantartási adatok inicializálása	Lásd a beltéri egység telepítési kézikönyvét.

A menü szerkezete és ikonja

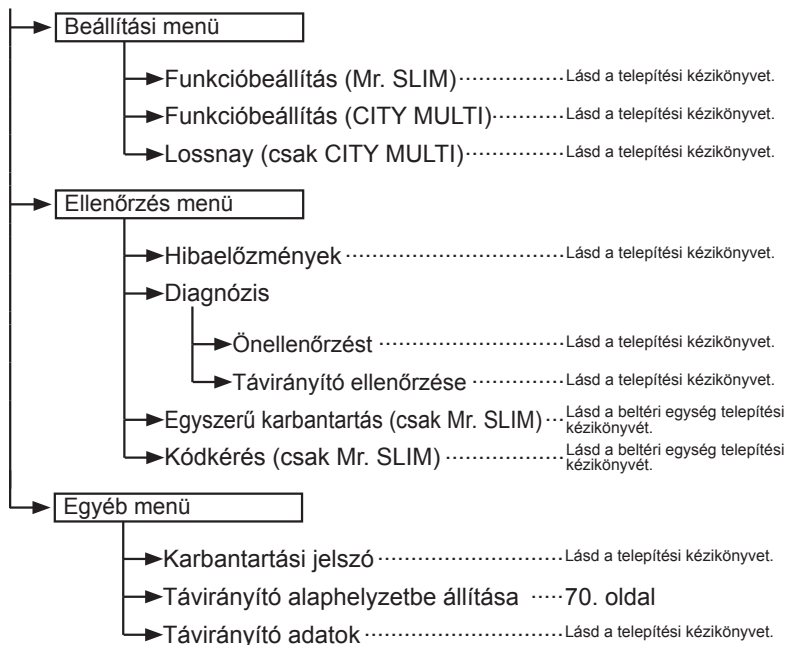

Nem érhető el minden funkció a beltéri egységek minden modelljén.

Vezérlő üzemeltetése

Időzítő



Az alábbi tábla összefoglalja az útmutatóban használt négyzetes ikonokat.



Az adminisztrátori vagy karbantartás felhasználói jelszót a jelszó beviteli képernyőn kell megadni a beállítások módosításához. Nincs olyan beállítás, melynek beállításához ez a folyamat átugorható.

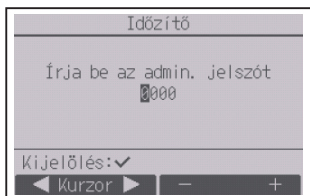

F1 F2 F3 F4

- F1** : nyomja meg a kurzor balra mozgatásához.
- F2** : nyomja meg a kurzor jobbra mozgatásához.
- F3** : nyomja meg az érték 1-el történő csökkentéséhez.
- F4** : nyomja meg az érték 1-el történő növeléséhez.

* Nem lehet módosításokat végrehajtani, amíg a helyes jelszót meg nem adja.



Olyan beállításokat jelöl, melyeket csak aközben lehet elvégezni, hogy az egységek üzemelnek.



Olyan beállításokat jelöl, melyeket csak aközben lehet elvégezni, hogy az egységek nem üzemelnek.



Azokat a beállításokat jelöli, melyeket csak akkor lehet módosítani, amikor az egységek a Hűt, Fűt vagy Auto üzemmódban vannak.



Olyan funkciókat jelöl, melyek nem elérhetőek, ha a gombok le vannak zárva, vagy ha a rendszer központilag vezérelt.

Alapvető műveletek

Teljesítmény BE/KI



Gomb műveletek

BE



BE/KI gomb

Nyomja meg a **BE/KI** gombot.

A BE/KI lámpa zölden világít és megkezdődik az üzem.

Ha a „LED világítás” beállítása „Nem”, a BE/KI lámpa nem kapcsol be.

KI

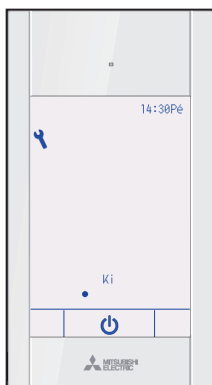

Nyomja meg újra a **BE/KI** gombot.

A BE/KI lámpa kialszik, az üzemelés pedig leáll.

Üzem mód, hőmérséklet, ventilátorsebesség, terelő, zsalu és ventiláció (Lossnay) beállításai



Gomb műveletek

Üzem mód

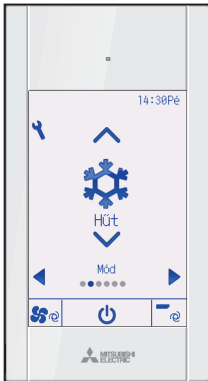

A ▼ vagy ▲ gombok megnyomásával az alábbi üzemmódok között válthat ciklikusan.

Válassza ki a kívánt üzemmódot.



Hűt



Szárít



Ventilátor



Auto



Fűt

- Az adott modellű csatlakoztatott beltéri egységek esetében nem elérhető üzemmódok nem jelennek meg a kijelzőn.

A villogó mód ikon jelentése

A mód ikon akkor villog, amikor a másik beltéri egység ugyanabban a hűtőközeges rendszerben (Ugyanahhoz a kültéri egységhez csatlakoztatva) már egy másik üzemmódban üzemel. Ebben az esetben, az egység maradék része ugyanabban a csoportban csak ugyanabban az üzemmódban üzemeltethető.

<Auto (duális beállítási pont) mód>

Amikor az üzemmód Auto módra van állítva (duális beállítási pont), két hőmérsékletet lehet előre beállítani (egyét hűtéshez és egyet fűtéshez). A helyiség hőmérsékletétől függően, a beltéri egység Hűt vagy Fűt módban üzemel, és a hőmérsékletet az előre beállított tartományban tartja.

Az alábbi ábrán látható az Auto (duális beállítási pont) módban üzemelő beltéri egység működési sémája.

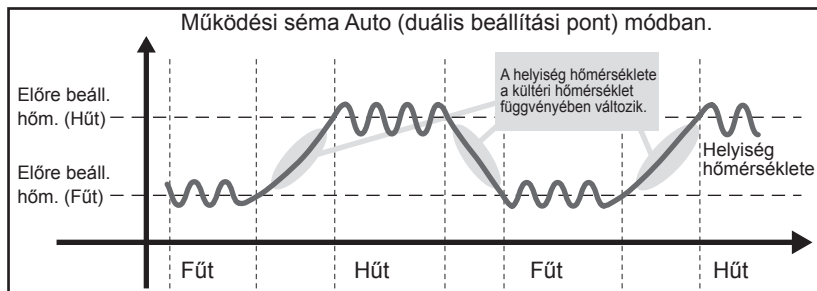



Alapvető műveletek

Előre beállított hőmérséklet

<Hűt, Szárit, Fűt és Auto (szimpla beállítási pont)>





A  gomb megnyomásával csökkentheti, a  megnyomásával pedig növelheti az előre beállított hőmérsékletet.

- Lásd a táblázatot a 19. oldalon a különböző üzemmódokhoz beállítható hőmérséklet-tartományokhoz.
- Előre beállított hőmérséklet-tartomány nem adható meg a ventilátor/ventiláció módhoz.
- Az előre beállított hőmérséklet jelenik meg 0,5 vagy 1 Celsius-, illetve Fahrenheit-fokos lépésközökben a beltéri egység típusától vagy a távvezérlő kijelzési mód beállításától függően.

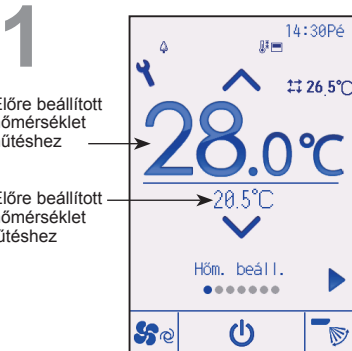
<Auto (duális beállítási pont) mód>



Megjelennek az aktuális előre beállított hőmérsékletek.

A  vagy  gombok megnyomásával az előre beállított hőmérsékletek változtathatók hűtéshez vagy fűtéshez.

2

Előre beállított hőmérséklet hűtéshez

Előre beállított hőmérséklet fűtéshez

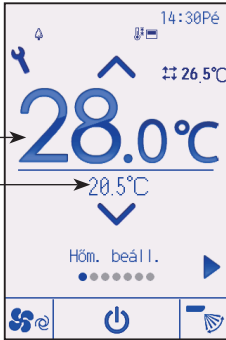

A ▼ gomb megnyomásával csökkentheti, a ▲ megnyomásával pedig növelheti az előre kiválasztott hőmérsékletet.

- Lásd a lenti táblázatot a különböző üzemmódokhoz beállítható hőmérséklet-tartományokhoz.
- Az Auto (duális beállítási pont) üzemmódban hűtéshez és fűtéshez előre beállított hőmérsékleti érték beállításokat alkalmaznak a hűt/szárít és fűt módok is.
- Az Auto (duális beállítási pont) módban, a hűtéshez és fűtéshez előre beállított hőmérsékleti értékeknek meg kell felelni az alábbi követelményeknek:
 - Az előre beállított hűtési hőmérséklet magasabb, mint az előre beállított fűtési hőmérséklet.
 - Az előre beállított hűtési és fűtési hőmérséklet közötti minimális különbség feltétele teljesül (a csatlakoztatott beltéri egység típusától függően változó).
 - Ha az előre beállított hőmérsékleteket úgy állították be, hogy nem teljesül a minimális hőmérsékleti különbség feltétele, mindkét előre beállított hőmérséklet automatikusan a megengedhető beállítási tartományon belüli értékre változik.

Előre beállítható hőmérséklet-tartomány

Üzemmód	Előre beállított hőmérséklet-tartomány
Hűt/Szárít	19 ~ 30°C (67 ~ 87°F)
Fűt	17 ~ 28°C (63 ~ 83°F)
Auto (Szimpla beállítási pont)	19 ~ 28°C (67 ~ 83°F)
Auto (Duális beállítási pont)	[Hűt] Előre beállított hőmérséklet-tartomány „Hűt” módhoz [Fűt] Előre beállított hőmérséklet-tartomány „Fűt” módhoz
Vent./Ventiláció	Nem megadható

Az előre beállítható hőmérsékleti tartomány a beltéri egységek modelljei szerint változnak.

Alapvető műveletek

Ventilátorsebesség



A ▼ vagy ▲ gombok megnyomásával az alábbi ventilátorsebességek között válthat ciklikusan.



- Az elérhető ventilátorsebességek a csatlakoztatott beltéri egység modelljétől függenek.

Terelő beállítása



(Minta képernyő a CITY MULTIn)

A ▼ vagy ▲ gombok megnyomásával az alábbi terelő beállítások között válthat ciklikusan.
Válassza ki a kívánt beállítást.

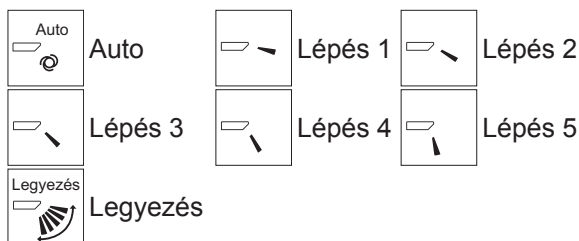

Válassza a „Legyezés” opciót a terelők automatikus fel-le mozgásához.

Amikor a „Lépés 1” és „Lépés 5” közötti módokat választja, a terelő a kiválasztott szögben kerül rögzítésre.

- **1h** a terelő beállítása ikon bal oldalán
Ez az ikon jelenik meg, amikor a terelő a Lépés 2, 3, 4 vagy 5 állásban van, és a ventilátor alacsony sebességgel üzemel hűtési vagy szárítási üzem (modelljétől függően) során.
Az ikon egy órán belül kialszik, és a lapát beállítások automatikusan változnak.

Zsalu beállítása

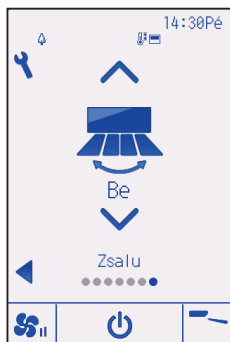

Nyomja meg a ▼ vagy ▲ gombot a zsalu legyezésének be- vagy kikapcsolásához.

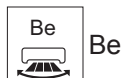

(Minta képernyő a CITY MULTIn)

Ventiláció beállítása

A ventiláció beállítása akkor is elvégezhető, ha az egység éppen műveletet végez.

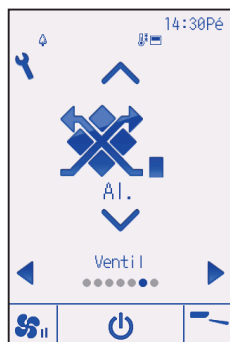

A ▼ vagy ▲ gombok megnyomásával az alábbi ventilációs beállítások között válthat ciklikusan.

* Csak akkor állítható, ha van csatlakoztatott Lossnay egység.



• A beltéri egységek egyes modelljeinek ventilátora reteszelve lehet bizonyos modellek ventilációs egységeivel.

(Minta képernyő a Mr. SLIM-en)

Navigálás a menüben

Fő menü listája

Fő menü	Beállítási pontok		Beállítási részletek	Oldal
Művelet	Nagy teljesítmény		Használja a kívánt szobahőmérséklet gyors eléréséhez. • Az egységek nagy teljesítményű üzemmódban akár 30 percig is üzemeltethetők.	25
	Kényelem	Terelőlap manuális szöge	Az egyes terelők szögének rögzítésére szolgál.	26
Időzítő	Időzítő	Időzítő be/ki	Használja a be/ki kapcsolási időzítéshez. • Az idő 5-perces időközökkel állítható be. * Az órát be kell állítani.	29
		Auto kikapcsolás időzítő	Használja az automatikus kikapcsolási idő megadásához. • Az időt 30 és 240 közötti értékre lehet beállítani 10 perces időközökkel.	32
	Heti időzítő		Használja a heti üzemidő be/ki kapcsolási időzítéshez. • Akár nyolc üzemi mintát állíthat be minden napra. • Kétféle heti ütemezés állítható be. * Az órát be kell állítani. * Nem érvényes, amikor az időzítő be/ki engedélyezve van. * 1°C-os lépésközök	34
	Kültéri egység halk üzemmód		Használja az időperiódus beállításához, hogy mikor szeretné a kültéri egység csendes üzemeltetését előtérbe helyezni a hőmérsékletszabályozással szemben. Állítsa be az Indítás/Leállítás időt a hét minden napja esetében. • Válassza ki a kívánt csendességi fokot a „Norm”, „Közepes”, és „Halk”. * Az órát be kell állítani.	37
	Éjszakai csökkentett üzemmód		Használja az Éjszakai csökkentett üzemmód beállításokat. • Válassza az „Igen” opciót a beállítás engedélyezéséhez, illetve a „Nem” opciót a beállítás letiltásához. A hőmérsékleti tartomány és a kezdési/leállítási idő is beállítható. * Az órát be kell állítani. * 1°C-os lépésközök	40
Energiatakarékos	Korlátozás	Hőmérséklet-tartomány	Használja ezt az előre beállított hőmérsékleti tartomány korlátozásához. • A különböző üzemmódokhoz eltérő hőmérsékleti tartományok állíthatók be. * 1°C-os lépésközök	43
		Művelet lezárva	Használja ezt a választott funkciók lezárásához. • A lezárt funkciók nem használhatók.	46
	Energiatakarékos	Auto vissza	Használja ezt, ha szeretné, hogy az egységek visszatérjenek az előre beállított hőmérsékletre miután bizonyos ideig energiatakarékos üzemmódban üzemelt. • Az időt 30 és 120 közötti értékre lehet beállítani 10 perces időközökkel. * Ez a funkció nem lesz érvényben, ha az előre beállított hőmérséklet tartományok korlátozva vannak. * 1°C-os lépésközök	49

Fő menü	Beállítási pontok	Beállítási részletek	Oldal	
Energiatakarékos	Energiatakarékos	<p>Ütemezés</p> <p>Állítsa be azokat az indítás/leállítás időpontokat, amikor az egységet energiatakarékos üzemmódban szeretné üzemeltetni a hét minden napján, és állítsa be az energiatakarékossági szintet.</p> <ul style="list-style-type: none"> • Akár négy energiatakarékos működési mintát is be lehet állítani minden naphoz. • Az idő 5-perces időközökkel állítható be. • Az energiatakarékos szinteket 0%-tól kezdve és 50-től 90%-ig állíthatja 10%-os lépésközökben. * Az órát be kell állítani. 	51	
Kezdeti beállítás	Alapbeállítás	Óra	Használja az aktuális idő megadásához.	54
		Nyári időszámítás	Beállítja a nyári időszámítást.	56
	Kijelzési beállítás	Fő kijelző	Használja ezt a „Teljes” és „Alap” módok közötti váltáshoz az állapotkijelzőn és a fő kijelzőn. • Az alapértelmezett beállítás „Teljes”.	58
		Fényerő	Használja ezt a képernyő fényerejének beállításához.	61
		Nyelvválasztás	Használja ezt a kívánt nyelv kiválasztásához.	62
		Megjelenés	Az állapotkijelző és a fő kijelző színének változtatására szolgál.	64
	Érintőpanel	Érintőpanel kalibrálása	Az érintőpanel kalibrációs beállítására szolgál.	66
Érintőpanel tisztítása		A tisztításhoz ideiglenesen érintésre érzéketlenné teszi az érintőpanelt.	68	
Szerviz	Távírányító alaphelyzetbe állítása	A távvezérlő gyári kiszállítási helyzetbe való visszaállítására szolgál.	70	
	Távírányító adatok	A távvezérlő modellnevének, szoftververziójának és sorozatszámának kijelzésére szolgál.	72	
Karbantartás	Hibainformációk	<p>Használja ezt a hiba információ ellenőrzéséhez, amikor hiba történik.</p> <ul style="list-style-type: none"> • Hibakód, hibaforrás, hűtőközeg címe, egység modell, gyári szám, kapcsolattartási adatok (kereskedő telefonszáma) jeleníthető meg. * Az egység modelljét, gyártási számát és kapcsolattartási adatait mielőtt megjeleníthető lenne, regisztrálni kell. 	74	
	Szűrőinformációk	<p>Használja ezt a szűrő állapotának ellenőrzéséhez.</p> <ul style="list-style-type: none"> • A szűrőjel visszaállítható. 	78	

Navigálás a menüben

Navigálás a fő menüben

Gomb műveletek

A fő menü elérése



Nyomja meg a **Beállítás** gombot a fő kijelzőn.

Megjelenik a fő menü.

Elem kiválasztása

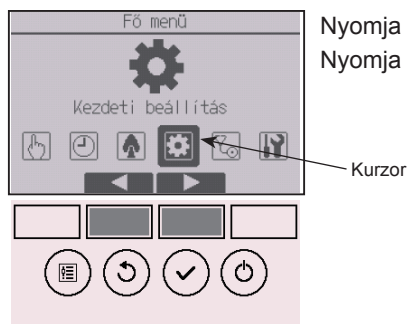

Nyomja meg **F2** gombot a kurzor balra mozgatásához.

Nyomja meg **F3** gombot a kurzor jobbra mozgatásához.

Funkcióbeállítások

Nagy teljesítmény



Funkció leírása

A nagy teljesítményű üzemeltetési funkció lehetővé teszi az egységek számára, hogy a normálnál nagyobb teljesítménnyel üzemeljenek, hogy a szoba optimális hőmérséklete minél gyorsabban elérhető legyen. Ez az üzem legalább 30 percig eltart, és az egység visszatér normál üzemi módba a 30 perc végén, vagy amennyiben a szoba hőmérséklete eléri az előre beállított hőmérsékletet. Amelyik előőbb következik be. Az egységek visszatérnek normál üzemi állapotba, amikor módosítja az üzemmódot vagy a ventilátor sebességét.

Gomb műveletek

1



Válassza a „Nagy teljesít.” opciót a „Művelet menüből” hűtés, fűtés vagy Auto üzem során, majd nyomja meg a **VÁLASZT** gombot.

A „Nagy teljesít.” funkció csak olyan modellek esetében érhető el, amelyek támogatják ezt a funkciót.

2



Vigye a kurzort az „Igen” gomb fölé az **F3** vagy **F4** gombbal, majd nyomja meg a **VÁLASZT** gombot.



Megjelenik egy jóváhagyó képernyő.

Navigálás a képernyők között

- Visszatérés a fő menübe **MENÜ** gomb
- Visszatérés az előző képernyőre **VISSZA** gomb

Funkcióbeállítások

Terelőlap manuális szöge

OFF

Gomb műveletek

1



Válassza ki a „Kényelem” opciót a művelet menüben, majd nyomja meg a **VÁLASZT** gombot.

2



Válassza a „Terelől. man. szöge” opciót az **F1** vagy **F2** gombbal, majd nyomja meg a **VÁLASZT** gombot.

3



Vigye a kurzort a „Ref.cím” vagy „Egység” opcióra az **F1** gombbal a kiválasztáshoz.

Válassza ki a hűtőközeg címét és az egység számát az egységekhez, melyek lapátjai rögzítve vannak, az **F2** vagy **F3** gombbal, majd nyomja meg a **VÁLASZT** gombot.

- Referencia címe: Hűtőközeg cím

- Egység szám: 1, 2, 3, 4

Nyomja meg az **F4** gombot az egység jóváhagyásához.

A bal oldali képernyőn a Mr. SLIM egy példa kijelzése látható. A CITY MULTI egységeken az „M-NET cím” jelenik meg a „Ref.cím” helyett, és az „Egység” nem jelenik meg.

4



Válassza ki az „Terelő” opciót az **F1** gombbal.

Válassza a „4-irá.” vagy „2-irá.” opciót az **F2** vagy **F3** gombbal, majd nyomja meg a **F4** gombot.

Funkcióbeállítások

5

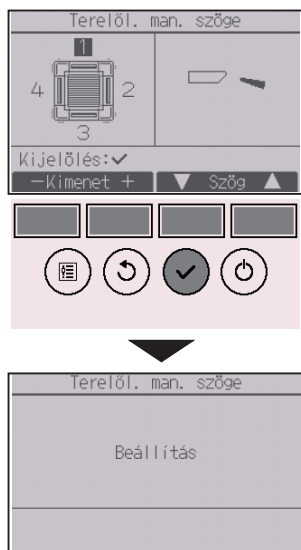

Megjelennek az aktuális lapát beállítások.

Válassza ki a kívánt kimenetet – „1”, „2”, „3”, „4” vagy „1, 2, 3, 4 (összes kimenet)” – az [F1] vagy [F2] gombbal.

Nyomja meg az [F3] vagy [F4] gombot, hogy végigmenjen az alábbi opciókon, majd válassza ki a kívánt beállítást.

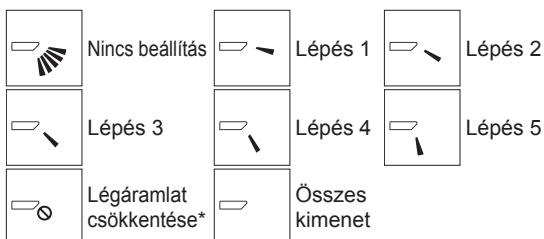

Nyomja meg a [VÁLASZT] gombot a beállítások mentéséhez.

Egy képernyő jelenik meg, mely a beállítási információ átvitelét jelöli.

A beállítás módosítások végrehajtásra kerülnek a választott kimenet esetében.

A képernyő automatikusan visszatér az előző képernyőhöz, miután az adatátvitel befejeződik. Végezze el a többi kimenet beállításait is, ugyanazokat a műveleteket követve.

Ha az összes kimenet ki van választva, jelenik meg a következő alkalommal, amikor a gép újból bekapcsol.

Navigálás a képernyők között

• Visszatérés az előző képernyőre [VISSZA] gomb

*Légáramlat csökkentése

A [Légáramlat csökkentése] üzemmód a lapátok szögét közelebb tartja a vízszinteshez, mint az 1. lépés szöge, így a légáramlat nem irányul az emberekre. Ez a funkció csak egy kivezetésre állítható be.

Ez a funkció nem állítható be olyan típus esetén, amely kettő vagy több kivezetéssel rendelkezik.

A Légáramlat csökkentése üzemmód használata a mennyezet elszíneződését okozhatja.

Időzítő (Időzítő be/ki)



Gomb műveletek

1



Válassza az „Időzítő” opciót a fő menüből (lásd 24. oldal), és nyomja meg a **VÁLASZT** gombot.

Az időzítő be/ki nem fog működni az alábbi esetekben:

amikor az időzítő be/ki le van tiltva, hiba során, ellenőrzés során (szerviz menüben), próbaüzem során, távvezérlő diagnózis során, amikor az óra nincs beállítva, funkcióbeállítások alatt, amikor a rendszer központilag vezérelt (amikor „Be/Ki” művelet vagy „Időzítő” művelet a helyi távvezérlőről nem megengedett).

2



Vigye a kurzort az „Időzítő” opcióra, majd nyomja meg a **VÁLASZT** gombot.

3

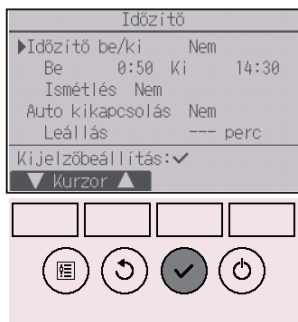

Megjelennek az aktuális beállítások.

Vigye a kurzort az „Időzítő be/ki” opcióra, majd nyomja meg a **VÁLASZT** gombot.

Funkcióbeállítások

4



Az időzítő beállításához megjelenik egy képernyő.

Válassza ki a kívánt elemet az **[F1]** vagy **[F2]** gombokkal az „Időzítő be/ki”, „Be”, „Ki” vagy „Ismétlés” opciók közül.

5



Módosítsa a beállítást az **[F3]** vagy **[F4]** gombbal.

- Időzítő be/ki: Nem (letiltás)/Igen (engedélyezés)
- Be: művelet kezdési ideje
(beállítható 5-perces időközökkel)
 - * Nyomja le és tartsa lenyomva a gombot a számok végigpörgetéséhez.
- Ki: művelet leállítási ideje
(beállítható 5-perces időközökkel)
 - * Nyomja le és tartsa lenyomva a gombot a számok végigpörgetéséhez.
- Ismétlés: Nem (egyszer)/Igen (ismétlés)

6

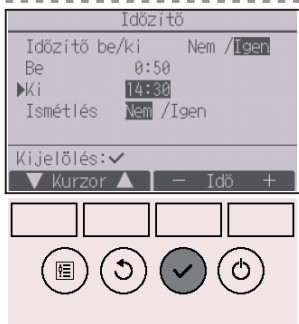

Nyomja meg a **VÁLASZT** gombot a beállítások mentéséhez.

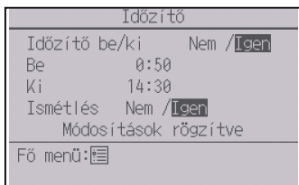



Megjelenik egy jóváhagyó képernyő.

Navigálás a képernyők között

- Visszatérés a fő menübe **MENÜ** gomb
- Visszatérés az előző képernyőre **VISSZA** gomb



 jelenik meg teljes módban az állapotkijelzőn és a fő kijelzőn, amikor az időzítő be/ki engedélyezve van.

 jelenik meg, ha a központi vezérlő rendszerben az időzítő nincs engedélyezve.

Funkcióbeállítások

Időzítő (Auto kikapcsolás időzítő)



Gomb műveletek

1



Előhívja az időzítő beállítás képernyőt.
(Lásd 29. oldal)

Válassza ki az „Auto kikapcsolás” elemet, majd nyomja meg a **VÁLASZT** gombot.

Az Auto kikapcsolás időzítő nem fog működni az alábbi esetekben:
amikor az auto kikapcsolás időzítő le van tiltva, hiba során, ellenőrzés során (szerviz menüben), próbaüzem során, távvezérlő diagnózis során, funkcióbeállítások alatt, amikor a rendszer központilag vezérelt (amikor „Be/Ki” művelet vagy „Időzítő” művelet a helyi vezérlőről nem megengedett).

2



Megjelennek az aktuális beállítások.

Vigye a kurzort az „Auto kikapcsolás” vagy „Leállítás --- perc után” opcióra az **F1** vagy **F2** gombbal.

3



Módosítsa a beállítást az **F3** vagy **F4** gombbal.

- Auto kikapcsolás: Nem (letiltás)/Igen (engedélyezés)
- Leállítás --- perc után: időzítő beállítása (a beállítható tartomány 30–240 perc 10 perces időközökkel.)

4



Nyomja meg a **VÁLASZT** gombot a beállítások mentéséhez.

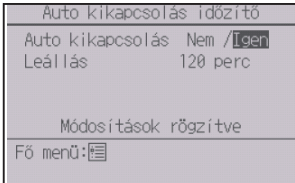



Megjelenik egy jóváhagyó képernyő.

Navigálás a képernyők között

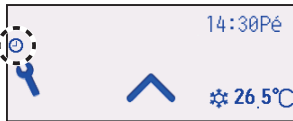
- Visszatérés a fő menübe **MENU** gomb
- Visszatérés az előző képernyőre **VISSZA** gomb



 jelenik meg teljes módban az állapotkijelzőn és a fő kijelzőn, amikor az Auto kikapcsolás időzítő engedélyezve van.

 jelenik meg, ha a központi vezérlő rendszerben az időzítő nincs engedélyezve.

Funkcióbeállítások

Heti időzítő



Gomb műveletek

1

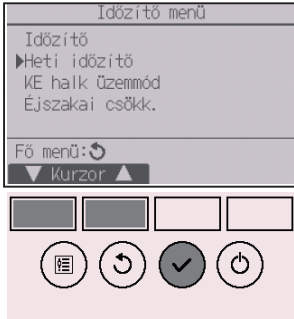

Válassza ki a „Heti időzítő” opciót az időzítő menüben, majd nyomja meg a **VÁLASZT** gombot.

A Heti időzítő nem fog működni az alábbi esetekben:

amikor az időzítő be/ki engedélyezve van, amikor a heti időzítő le van tiltva, hiba során, ellenőrzés során (szerviz menüben), próbaüzem során, távvezérlő diagnózis során, amikor az óra nincs beállítva, funkcióbeállítás alatt, amikor a rendszer központilag vezérelt (amikor Be/Ki művelet, hőmérséklet beállítás vagy időzítés művelet a helyi vezérlőről nem megengedett).

2



Megjelennek az aktuális beállítások.

Nyomja meg az **F1** vagy **F2** gombokat minden nap beállításainak megtekintéséhez.

Nyomja meg az **F3** gombot az 5.–8. minták megtekintéséhez.

Nyomja meg az **F4** gombot a 2. beállítás állapotának megjelenítéséhez.

Nyomja meg a **VÁLASZT** gombot a beállítások képernyőre ugráshoz.

3



Megjelenik a heti időzítő beállítási képernyő.

A „Művelet” beállításnál az **[F3]** vagy **[F4]** gombokkal válassza ki az „1” opciót az 1. időzítőbeállítás, vagy a „2” opciót a 2. időzítőbeállítás engedélyezéséhez. Ezután nyomja meg a **[VÁLASZT]** gombot.

Az 1. vagy 2. időzítőbeállítás tartalmának Ellenőrzéséhez az **[F1]** vagy **[F2]** gombokkal vigye a kurzort a „Beál.” opcióra, majd a **[F3]** vagy **[F4]** gombokkal válassza ki az „1” vagy „2” opciót.

4



A Heti időzítő beállítás képernyő megjelenik és az aktuális beállítások is megjelennek.

Akár nyolc üzemi mintát állíthat be minden napra. Vigye a kurzort a hét kívánt napjára az **[F1]** vagy **[F2]** gombbal, és nyomja meg az **[F3]** gombot a kiválasztásához. (Több nap is kiválasztható.)

Nyomja meg a **[VÁLASZT]** gombot.

Funkcióbeállítások

5

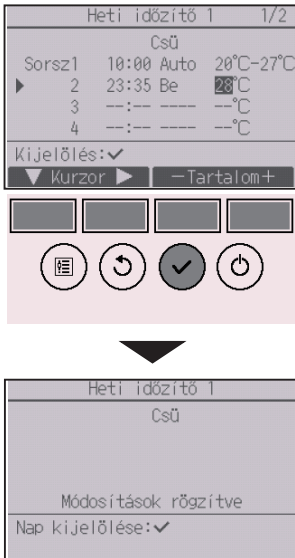

Az üzemi minta beállítás képernyő jelenik meg.

Nyomja meg az **[F1]** gombot a kurzor kívánt mintaszámára mozgatásához.

Vigye a kurzort az idő, Be/Ki vagy hőmérséklet opcióra az **[F2]** gombbal.

Módosítsa a beállításokat az **[F3]** vagy **[F4]** gombbal.

• Idő: beállítható 5 perces időközökkel

* Nyomja le és tartsa lenyomva a gombot a számok végigpörgetéséhez.

• Be/Ki/Auto: A választható beállítások a csatlakoztatott beltéri egység típusától függnnek. (Amikor egy „Auto” séma végrehajtódik, a rendszer „Auto” (duális beállítási pont) módban üzemel.)

• Hőmérséklet: az előre beállítható hőmérséklet-tartomány a csatlakoztatott beltéri egységtől függően változik. (1°C lépésköz)

Amikor az Auto (duális beállítási pont) módot

kiválasztották, két hőmérsékleti értéket lehet előre

beállítani. Ha az Auto (duális beállítási pont) mód közben

egy szimpla előre beáll. hőmérsékleti beállítású műveleti

séma végrehajtása zajlik, annak beállítása a Hűt üzemmód

hűtési hőmérséklet beállítása lesz.

Nyomja meg a **[VÁLASZT]** gombot a beállítások mentéséhez.

Megjelenik egy jóváhagyó képernyő.

Navigálás a képernyők között

- Visszatérés a beállítások módosítása/hét napjai képernyőre **[VÁLASZT]** gomb
- Visszatérés a fő menübe **[MENÜ]** gomb
- Visszatérés az előző képernyőre **[VISSZA]** gomb



[7] jelenik meg az állapotkijelzőn és a fő kijelzőn teljes módban, amikor a heti időzítő be van állítva egy adott napra.

Az ikon nem fog megjelenni, amikor az „Időzítő be/ki” megengedett vagy a rendszer központosított irányítás alatt üzemel (az „Időzítő” művelet a helyi távvezérlőről nem megengedett).

Funkció leírása

Ez a funkció lehetővé teszi, hogy beállítson egy időperiódust, hogy mikor szeretné a kültéri egység csendes üzemeltetését előtérbe helyezni a hőmérsékletszabályozással szemben. Állítsa be a kezdési és befejezési időt a hét minden napjára, a csendes üzemre vonatkozóan. Válassza ki a kívánt csendességi fokot a „Közepes” és „Halk” közül.

Gomb műveletek

1



Válassza ki a „KE halk üzemmód” opciót az időzítő menüben, majd nyomja meg a **VÁLASZT** gombot.

A „KE halk üzemmód” funkció csak olyan modellek esetében érhető el, melyek támogatják ezt a funkciót.

2



Megjelennek az aktuális beállítások.

Nyomja meg az **[F1]** vagy **[F2]** gombokat minden nap beállításainak megtekintéséhez.

Nyomja meg a **VÁLASZT** gombot a beállítások képernyőre ugráshoz.

Funkcióbeállítások

3



Megjelenik a csendes üzemmód engedélyezése (Igen) és letiltása (Nem).

A beállítás engedélyezéséhez vigye a kurzort az „Igen” gomb fölé az **F3** vagy **F4** gombbal, majd válassza a **VÁLASZT** gombot.

4



Az kültéri egység halk üzemmód beállítás képernyő jelenik meg.

A beállításhoz, vagy módosításhoz, vigye a kurzort a hét kívánt napjára az **F1** vagy **F2** gombbal, majd nyomja meg az **F3** gombot a kiválasztásához. (Több nap is kiválasztható.)

Nyomja meg a **VÁLASZT** gombot.

5

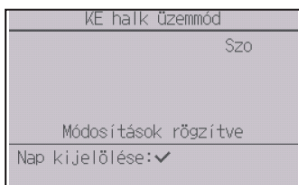

Megjelenik a beállítás képernyő.

Vigye a kurzort a kívánt elemre az **[F1]** vagy **[F2]** gombokkal az indítási idő, leállítási idő és halk szint kiválasztásához.

Módosítsa a beállításokat az **[F3]** vagy **[F4]** gombbal.

- Indítási/leállítási idő: beállítható 5 perces időközökkel
- * Nyomja le és tartsa lenyomva a gombot a számok végigpörgetéséhez.
- Halk szint: Normál, Közepes, Halk



Normál



Közepes



Halk

Nyomja meg a **[VÁLASZT]** gombot a beállítások mentéséhez. Megjelenik egy jóváhagyó képernyő.

Navigálás a képernyők között

- Visszatérés a beállítások módosítása/hét napjai képernyő **[VÁLASZT]** gomb
- Visszatérés a fő menübe **[MENU]** gomb
- Visszatérés az előző képernyőre **[VISSZA]** gomb



jelenik meg teljes módban az állapotkijelzőn és a fő kijelzőn kültéri egység halk üzemmód közben.

Funkcióbeállítások

Éjszakai csökkentett üzemmód



Funkció leírása

Ez a vezérlő akkor indítja el a fűtési műveletet, amikor a vezérlő tárgycsoport megállításra kerül és a szobahőmérséklet az előre beállított hőmérsékleti küszöb alá süllyed. Ez a vezérlő is akkor indítja el a hűtési műveletet, amikor a vezérlő tárgycsoport megállításra kerül és a szobahőmérséklet az előre beállított hőmérsékleti küszöb fölé emelkedik.

Az Éjszakai csökkentett üzemmód funkció nem elérhető, ha a művelet és a hőmérséklet beállítás a távvezérlőről kerül elvégzésre.

Ha a szobahőmérsékletet a légkondicionáló hőmérséklet érzékelője méri, a pontos hőmérséklet megállapítása hibás lehet, ha a légkondicionáló inaktív, vagy ha a levegő nem tiszta. Ebben az esetben kapcsolja az érzékelőt távoli érzékelőre (PAC-SE40TSA/PAC-SE41TS-E) vagy távvezérlő érzékelőre.

Gomb műveletek

1



Válassza ki az „Éjszakai csökk.” opciót az időzítő menüben, majd nyomja meg a **VÁLASZT** gombot.

2



Megjelennek az aktuális beállítások.

Nyomja meg a **VÁLASZT** gombot a beállítások képernyőre ugráshoz.

3



Az **[F1]** vagy **[F2]** gombokkal vigye a kurzort a kívánt elemre: éjszakai csökkentett Nem (letiltás)/Igen (aktiválás), hőmérséklet-tartomány, kezdési idő vagy leállítási idő.

Módosítsa a beállításokat az **[F3]** vagy **[F4]** gombbal.

- Hőm.-tartomány: az alsó hőmérsékleti küszöbérték (fűtési üzemhez) és a felső hőmérsékleti küszöbérték (hűtési üzemhez) beállítására szolgál. Az alsó és felső hőmérsékleti küszöbérték közötti különbségnek legalább 4°C (8°F) értéknek kell lennie. Az előre beállítható hőmérsékleti tartomány a csatlakoztatott beltéri egységektől függően változik.
 - * 1°C-os lépésközök
- Indítási/leállítási idő: beállítható 5 perces időközökkel
- * Nyomja le és tartsa lenyomva a gombot a számok végigpörgetéséhez.

Nyomja meg a **[VÁLASZT]** gombot a beállítások mentéséhez.

Megjelenik egy jóváhagyó képernyő.

Navigálás a képernyők között

- Visszatérés a fő menübe **[MENU]** gomb
- Visszatérés az előző képernyőre **[VISSZA]** gomb

Funkcióbeállítások



 jelenik meg teljes módban az állapotkijelzőn és a fő kijelzőn, amikor az éjszakai csökkentett funkció engedélyezve van.

 jelenik meg, ha a központi vezérlő rendszerben az időzítő nincs engedélyezve.

Az éjszakai csökkentett üzemmód nem működik az alábbi esetekben:

amikor az egység műveletet végez, amikor az éjszakai csökkentett funkció le van tiltva, hiba során, ellenőrzés során (szerviz menüben), próbaüzem során, távvezérlő diagnózis során, amikor az óra nincs beállítva, funkcióbeállítás alatt, amikor a rendszer központilag vezérelt (amikor Be/Ki művelet, hőmérséklet beállítás vagy időzítés művelet a helyi vezérlőről nem megengedett).

A hőmérséklet-tartomány korlátozás beállítása

Gomb műveletek

1



Válassza ki az „Energia takarékos” opciót a fő menüből (lásd 24. oldal), majd nyomja meg a **VÁLASZT** gombot.

2

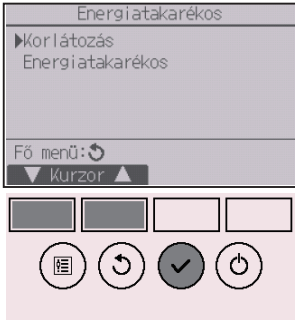

Vigye a kurzort az **[F1]** vagy **[F2]** gombokkal a „Korlátozás” opcióra, majd nyomja meg a **VÁLASZT** gombot.

Funkcióbeállítások

3



Megjelennek az aktuális beállítások.

Vigye a kurzort az **[F1]** vagy **[F2]** gombokkal a „Hőm.-tartomány” opcióra, majd nyomja meg a **[VÁLASZT]** gombot.

4



A hőmérséklet-tartomány beállításához megjelenik egy képernyő.

Vigye a kurzort a kívánt elem fölé az **[F1]** gombbal, válasszon a „Hőm.-tartomány”, „Hűt-Szárít” „Fűt” vagy „Auto” opciók közül.

5



Módosítsa a beállításokat az **F3** vagy **F4** gombbal.

- Hőm.-tartomány: Nem (nem korlátozott) vagy Igen (korlátozott)
- Hűt•Szárít: felső és alsó korlátozó hőmérséklet (1°C-os lépésközök)
- Fűt: felső és alsó korlátozó hőmérséklet (1°C-os lépésközök)
- Auto: felső és alsó korlátozó hőmérséklet (1°C-os lépésközök)

Hőmérsékletállítás tartománya

Mód	Alsó határ	Felső határ
Hűt•Szárít *1 *3	19 ~ 30°C (67 ~ 87°F)	30 ~ 19°C (87 ~ 67°F)
Fűt *2 *3	17 ~ 28°C (63 ~ 83°F)	28 ~ 17°C (83 ~ 63°F)
Auto *4	19 ~ 28°C (67 ~ 83°F)	28 ~ 19°C (83 ~ 67°F)

* Az előre beállítható tartomány a csatlakoztatott beltéri egységektől függően változik.

*1 A hűt, szárít és Auto (duális beállítási pont) módok hőmérséklet-tartományait lehet beállítani.

*2 A fűt és Auto (duális beállítási pont) üzemmódok hőmérséklet-tartományait lehet beállítani.

*3 A fűt, hűt és szárít üzemmódok hőmérséklet-tartományainak meg kell felelnie az alábbi követelményeknek:

- A hűtés felső határa - fűtés felső határa \geq minimális hőmérsékleti különbség (beltéri egység típusától függően változik)
- Hűtés alsó határa - fűtés alsó határa \geq minimális hőmérsékleti különbség (beltéri egység típusától függően változik)

*4 Az Auto (szimpla beállítási pont) üzemmód hőmérséklet-tartományát lehet beállítani.

Nyomja meg a **VÁLASZT** gombot a beállítások mentéséhez.

Megjelenik egy jóváhagyó képernyő.

Navigálás a képernyők között

- Visszatérés a fő menübe **MENÜ** gomb
- Visszatérés az előző képernyőre **VISSZA** gomb



 jelenik meg teljes módban az állapotkijelzőn és a fő kijelzőn, amikor a hőmérséklettartomány korlátozva van.

Funkcióbeállítások

Korlátozás

P

Művelet lezárása funkció

Gomb műveletek

A műveleti zár funkció aktiválásához állítsa a „Művelet lezárva” elemet „Igen” helyzetbe.

1



Előhívja a korlátozás beállítása képernyőt. (Lásd 43. oldal)

Vigye a kurzort a „Művelet lezárva” elemre, majd nyomja meg a **VÁLASZT** gombot.

2

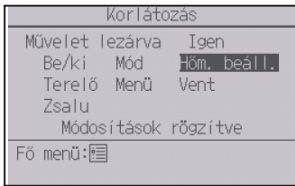

Megjelenik a művelet lezárása funkció beállítások elvégzéséhez szükséges képernyő.

Vigye a kurzort a kívánt elemre az [F1] vagy [F2] gombokkal: „Művelet lezárva”, „Helyszín”, „Be/Ki”, „Mód”, „Hőm. beáll.”, „Menü”, „Vent”, „Zsalu” vagy „Terelő”.

Módosítsa a beállításokat az [F3] vagy [F4] gombbal.

- Művelet lezárva: Nem (letiltás)/Igen (engedélyezés)
- Helyszín: „Egyéni” vagy „Hotel”
- Be/Ki: Be/Ki művelet
- Mód: üzemmód beállítása
- Hőm. beáll.: hőmérséklet előbeállítása
- Terelő: terelő beállítása
- Menü: menü beállítása
- Vent: ventilátorsebesség beállítása
- Zsalu: zsalu beállítása

„-” / „Zárolva”

Ha a „Helyszín” beállításhoz a „Hotel” lett kiválasztva, az alábbi műveletek automatikusan zárolásra kerülnek: mód, terelő, menü és zsalu.

Nyomja meg a [VÁLASZT] gombot a beállítások mentéséhez.

Megjelenik egy jóváhagyó képernyő.

Navigálás a képernyők között

- Visszatérés a fő menübe [MENÜ] gomb
- Visszatérés az előző képernyőre [VISSZA] gomb

Funkcióbeállítások



 jelenik meg teljes módban az állapotkijelzőn és a fő kijelzőn, amikor a műveletlezárási funkcióbeállítás engedélyezve van.

Az műveleti útmutató, mely a lezárt funkcióhoz tartozik felülvezérlésre kerül.

A fő menü megjelenéséhez, amíg a menü beállítás le van zárva, nyomja meg és legalább tíz másodpercig tartsa lenyomva a **Beállítás** gombot. Adja meg az Adminisztrátori jelszót a jelszó beviteli képernyőn.

Automatikus visszalépés az előre beállított hőmérsékletre

Miután az Auto vissza funkció engedélyezésre került, ha az üzemmód megváltozik, vagy Be/Ki művelet kerül végrehajtásra erről a távvezérlőről, a beállított hőmérséklet automatikusan visszatér a szükséges hőmérsékletre, függetlenül a beállított időtől.

Gomb műveletek

- 1**
- Válassza ki az „Energiatakarékos” opciót az energiatakarékos menüben, majd nyomja meg a **VÁLASZT** gombot.



Válassza ki az „Energiatakarékos” opciót az energiatakarékos menüben, majd nyomja meg a **VÁLASZT** gombot.

- 2**
- Megjelennek az aktuális beállítások.
- Vigye a kurzort az **F1** vagy **F2** gombokkal a „Auto vissza” opcióra, majd nyomja meg a **VÁLASZT** gombot.



Funkcióbeállítások

3



Megjelenik az előre beállított hőmérsékletre való automatikus visszatérés beállítási ablaka.

Vigye a kurzort a kívánt elemre az **F1** vagy **F2** gombokkal: „Auto vissza”, „Hűtés”, vagy „Fűtés”.

4



Módosítsa a beállításokat az **F3** vagy **F4** gombbal.

- Auto vissza: Nem (letiltás)/Igen (engedélyezés)
- Hűtés: az időzítő beállítási tartománya 30 -120 perc, 10 perces időközökkel.
A hőmérséklet beállítási tartománya 19 – 30°C (67 – 87°F) (1°C-os lépésközökkel).
- Fűtés: az időzítő beállítási tartománya 30 –120 perc, 10 perces időközökkel.
A hőmérséklet beállítási tartománya 17 – 28°C (63 – 83°F) (1°C-os lépésközökkel).

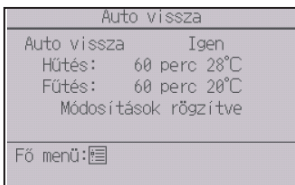

Nyomja meg a **VÁLASZT** gombot a beállítások mentéséhez. A „Hűtés” „Szárít” és „Auto Hűt” funkciókkal, a „Fűtés” pedig „Auto Fűt” móddal. A kiválasztott elem beállításához megjelenik egy képernyő.

Navigálás a képernyők között

- Visszatérés a fő menübe **MENÜ** gomb
- Visszatérés az előző képernyőre **VISSZA** gomb

Időzítő vagy előre beállított hőmérsékleti beállítások nem lépnek életbe, ha a hőmérséklet-tartomány korlátozott, és ha a rendszer központi vezérlésű (amikor hőmérséklet-tartomány beállítás egy helyi vezérlőről nem megengedett). Amikor a rendszer központi vezérlésű (amikor az „Időzítő” művelet egy helyi távvezérlőről le van tiltva), csak az „Időzítő” beállítás fog működni.

Az energiatakarékos üzemi ütemezés beállítása

Gomb műveletek

1



Lépjen az „Energiatakarékos” képernyőre. (Lásd 49. oldal)

Vigye a kurzort az „Ütemezés” opcióra, majd nyomja meg a **VÁLASZT** gombot.

2



Az ütemterv beállításához megjelenik egy képernyő.

Nyomja meg az **F1** vagy **F2** gombokat minden nap beállításainak megtekintéséhez.

Nyomja meg a **VÁLASZT** gombot a beállítások képernyőre ugráshoz.

3



Megjelenik az energiatakarékos üzem ütemezésének engedélyezései (Igen)/(Nem) letiltási képernyő.

Az **F3** vagy **F4** gombokkal válasszon a „Nem”, vagy „Igen” lehetőségek közül.

A beállítások módosítása/hét napjai képernyőre lépéshez nyomja meg a **VÁLASZT** gombot.

Funkcióbeállítások

4



Megjelenik a beállítások módosítása/hét napjai kiválasztási képernyő.

Akár négy üzemelési mintát is be lehet állítani minden naphoz.

Vigye a kurzort a hét kívánt napjára az **[F1]** vagy **[F2]** gombbal, és nyomja meg az **[F3]** gombot a kiválasztásához. (Több nap is kiválasztható.)

Nyomja meg a **VÁLASZT** gombot a minta beállítási képernyőre ugráshoz.

5



Megjelenik a minta beállítási képernyő.

Nyomja meg az **[F1]** gombot a kurzor kívánt mintaszámára mozgatásához.

Vigye a kurzort a kívánt elemre az **[F2]** gombbal: indítási idő, leállítási idő, és energiatekarékosági szint (ebben a sorrendben balról jobbra).

Módosítsa a beállításokat az **[F3]** vagy **[F4]** gombbal.

- Indítási /leállítási idő: beállítható 5 perces időközökkel
- * Nyomja le és tartsa lenyomva a gombot a számok végigpörgetéséhez.
- Energiatekarékosági szint: beállítható 0% és 50–90% tartományban 10%-os lépésközzel.

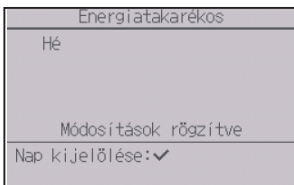

Nyomja meg a **VÁLASZT** gombot a beállítások mentéséhez.

Megjelenik egy jóváhagyó képernyő.

Minél alacsonyabb az érték, annál erősebb az energiatekarékosági hatás.



 megjelenik az állapotkijelzők és a fő kijelzőn teljes módban, amikor az egység energiatakarékos módban üzemel.

Navigálás a képernyők között

- Visszatérés a beállítások módosítása/hét napjai képernyőre **VÁLASZT** gomb
- Visszatérés a fő menübe **MENU** gomb
- Visszatérés az előző képernyőre **VISSZA** gomb

Funkcióbeállítások

Óra

P

Gomb műveletek

1

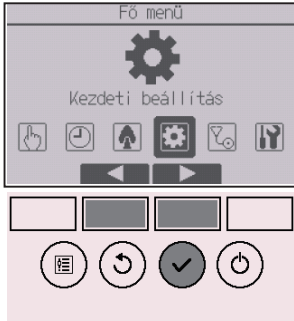

Válassza a „Kezdeti beállítás” opciót a fő menüből (lásd 24. oldal), és nyomja meg a **VÁLASZT** gombot.

Az óra beállítások elvégzése szükséges a következő beállítások elvégzése előtt.

- Időzítő be/ki
- Heti időzítő
- Kültéri egység halk üzemmód
- Energiatakarékos
- Éjszakai csökkentett üzemmód

Ha az adott rendszer nem rendelkezik rendszervezérlővel, az óra ideje nem módosul automatikusan. Ebben az esetben, rendszeres időközönként állítsa be az óra idejét.

2



Vigye a kurzort az **[F1]** vagy **[F2]** gombokkal az „Alapbeáll.” opcióra, majd nyomja meg a **VÁLASZT** gombot.

3



Válassza az „Óra” opciót az **[F1]** vagy **[F2]** gombbal, majd nyomja meg a **VÁLASZT** gombot.

4



Vigye a kurzort az **[F1]** vagy **[F2]** gombokkal az „Óra” opcióra, majd nyomja meg a **[VÁLASZT]** gombot.

5



Vigye a kurzort a kívánt elem fölé az **[F1]** vagy **[F2]** gombokkal az év, hónap, nap, óra vagy perc fölé. Növelje vagy csökkentse a kiválasztott elem értékét az **[F3]** vagy **[F4]** gombokkal, majd nyomja meg a **[VÁLASZT]** gombot.

Megjelenik egy jóváhagyó képernyő.

Navigálás a képernyők között

- Visszatérés a fő menübe **[MENÜ]** gomb
- Visszatérés az előző képernyőre **[VISSZA]** gomb

Funkcióbeállítások

Nyári időszámítás



Funkció leírása

Beállítható a nyári időszámítás kezdési és befejezési ideje. A nyári időszámítás funkció a beállítások tartalmának függvényében aktiválódik.

- Ha egy adott rendszer rendelkezik rendszervezérrel, a helyes idő megőrzése érdekében kapcsolja ki ezt a beállítást.
- A nyári időszámítás kezdetén és végén az időzítő kétszer aktiválódik vagy egyszer sem.
- Ez a funkció csak akkor működik, ha az óra be volt állítva.

Gomb műveletek

1



Válassza ki az „Óra” opciót az alapbeállítás menüben, majd nyomja meg a **VÁLASZT** gombot.

2



Vigye a kurzort az **F1** vagy **F2** gombokkal a „Nyári időszámítás” opcióra, majd nyomja meg a **VÁLASZT** gombot.

3

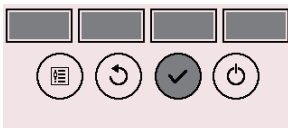
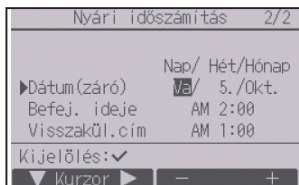
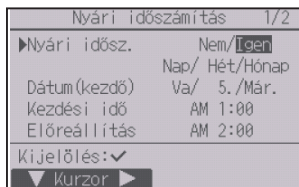

Az **[F1]** gombbal vigye a kurzort a következő elemekre, hogy elvégezze a beállítást.

- **Nyári időszak.**
Válassza ki a „Nem” (letiltás) vagy „Igen” (engedélyezés) lehetőséget az **[F2]** gombbal. Az alapértelmezett beállítás „Nem”.
- **Dátum(kezdő)*1**
Állítsa be a hét napját, a hét számát, a hónapot az **[F3]** vagy az **[F4]** gombokkal. Az alapértelmezett beállítás „Va/5./Már.”
- **Kezdési idő**
Adja meg a nyári időszámítás kezdési idejét az **[F3]** vagy az **[F4]** gombokkal.
- **Előreállítás**
Az **[F3]** vagy **[F4]** gombokkal adja meg az időpontot, amikor az órát előre kell állítani a fent megadott kezdési időre.
- **Dátum(záró)*1 (2. oldal)**
Állítsa be a hét napját, a hét számát, a hónapot az **[F3]** vagy az **[F4]** gombokkal. Az alapértelmezett beállítás „Va/5./Okt.”
- **Befej. ideje (2. oldal)**
Adja meg a nyári időszámítás befejezési idejét az **[F3]** vagy az **[F4]** gombokkal.

- **Visszakül.cím (2. oldal)**
Az **[F3]** vagy **[F4]** gombokkal adja meg az időpontot, amikor az órát vissza kell állítani a fent megadott záró időpontra.

*1 Ha a hét száma esetén „5.” van kiválasztva és az 5. hét nem létezik a kiválasztott hónapban, a beállítást a rendszer „4.” hétnek minősíti.

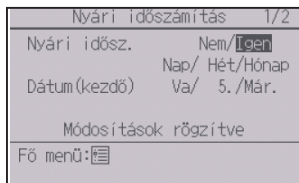

Nyomja meg a **[VÁLASZT]** gombot a beállítások mentéséhez.

Megjelenik egy jóváhagyó képernyő.

Navigálás a képernyők között

- Visszatérés a fő menübe **[MENU]** gomb
- Visszatérés az előző képernyőre **[VISSZA]** gomb

Funkcióbeállítások

Fő kijelző



Gomb műveletek

1



Válassza ki a „Kijel. beáll.” opciót a kezdeti beállítás menü menüben, majd nyomja meg a **VÁLASZT** gombot.

2



Vigye a kurzort az **F1** vagy **F2** gombokkal a „Fő kijelző” opcióra, majd nyomja meg a **VÁLASZT** gombot.

3



Válassza a „Teljes” vagy „Alap” opciót (lásd 10. oldal) az **F3** vagy **F4** gombbal, és nyomja meg a **VÁLASZT** gombot.

Megjelenik egy jóváhagyó képernyő.

Navigálás a képernyők között

- Visszatérés a fő menübe **MENÜ** gomb
- Visszatérés az előző képernyőre **VISSZA** gomb

Gomb műveletek

1



Válassza ki a „Kijel. beáll.” opciót a kezdeti beállítás menü menüben, majd nyomja meg a **VÁLASZT** gombot.

2



Vigye a kurzort az **F1** vagy **F2** gombokkal a „Fő kijelző” opcióra, majd nyomja meg a **VÁLASZT** gombot.

3



Válassza ki az **F1** vagy **F2** gombokkal az „Ikon magyaráz.”, illetve az **F3** vagy **F4** gombokkal a kívánt „Igen” vagy „Nem” opciót, majd nyomja meg a **VÁLASZT** gombot.

Az alapértelmezett beállítás „Igen”.

Navigálás a képernyők között

- Visszatérés a fő menübe **MENÜ** gomb
- Visszatérés az előző képernyőre **VISSZA** gomb

Funkcióbeállítások

4

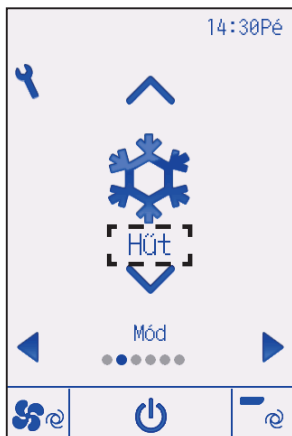

Ha az „Igen” opció van kiválasztva, a beállítási pont ikonjának magyarázata megjelenik a bal oldalt látható módon.

Gomb műveletek

1



Válassza ki a „Kijel. beáll.” opciót a kezdeti beállítás menü menüben, majd nyomja meg a **VÁLASZT** gombot.

2



Vigye a kurzort az **F1** vagy **F2** gombokkal a „Fényerő” opcióra, majd nyomja meg a **VÁLASZT** gombot.

3



Állítsa be a fényerőt az **F1** vagy **F2** gombbal. Az **F4** gombbal a „Világít” beállításához „BE” vagy „K1” választható.

Az „BE” kiválasztásával a háttérfény halványan égve marad, még ha a megadott idő le is telik.

Navigálás a képernyők között

- Visszatérés a fő menübe **MENÜ** gomb
- Visszatérés az előző képernyőre **VISSZA** gomb

Funkcióbeállítások

Nyelvválasztás



Funkció leírása

A kívánt nyelv beállítható. A nyelvek közül az angol, francia, német, spanyol, olasz, portugál, svéd, orosz, görög, török, holland, cseh, magyar és lengyel érhető el.

Gomb műveletek

1



Válassza ki a „Kijel. beáll.” opciót a kezdeti beállítás menü menüben, majd nyomja meg a **VÁLASZT** gombot.

2



Vigye a kurzort az **F1** vagy **F2** gombokkal a „Nyelvválasztás” opcióra, majd nyomja meg a **VÁLASZT** gombot.

3



Vigye a kurzort a kívánt nyelvre az **F1** – **F4** gombokkal, majd nyomja meg a **VÁLASZT** gombot a beállítás mentéséhez.

Az első alkalommal történő bekapcsolást követően a nyelvválasztás képernyő jelenik meg. Válassza ki a kívánt nyelvet. A rendszer nem indul be a nyelv kiválasztása nélkül.

Egy képernyő jelenik meg, mely a beállítás mentését jelöli.

Navigálás a képernyők között

- Visszatérés a fő menübe **MENÜ** gomb
- Visszatérés az előző képernyőre **VISSZA** gomb

Funkcióbeállítások

Megjelenés



Gomb műveletek

1



Válassza ki a „Kijel. beáll.” opciót a kezdeti beállítás menü menüben, majd nyomja meg a **VÁLASZT** gombot.

2



Vigye a kurzort az **F1** vagy **F2** gombokkal a „Megjelenés” opcióra, majd nyomja meg a **VÁLASZT** gombot.

3



Válassza ki a „Szín” opciót az **F4** gombbal.

- Szín: a kijelzés színe választható ki. (Lásd következő oldal.)
- Fehér: monokróm kijelzés (fehér alap)
- Fekete: monokróm kijelzés (fekete alap)

Ha a „Fehér” vagy a „Fekete” lett kiválasztva, nyomja meg a **VÁLASZT** gombot. Ha a „Szín” lett kiválasztva, a következő oldalon leírtak alapján válassza ki a kívánt színt.

4

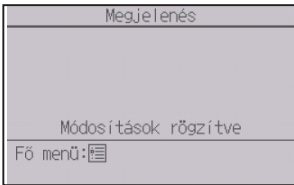

Válassza ki az **[F1]** vagy **[F2]** gombokkal az alábbi pontot, majd állítsa be a kívánt kijelzési színt az egyes pontokhoz.

- Színárnyalat: állítsa be a színárnyalatot az **[F3]** vagy **[F4]** gombbal. (A beállítható tartomány -90 – 89.)
- Minta: állítsa be a színt a **[F4]** gombbal.
- Szín. beáll.: válassza a „Karakter” vagy „Háttér” opciót, hogy amelyre vonatkozóan a **[F4]** gombokkal szeretné a színt megváltoztatni.

A funkciógomb alatti mintaszín a beállításnak megfelelően változik.

Állítsa be a kívánt színt, majd nyomja meg a **[VÁLASZT]** gombot.

Navigálás a képernyők között

- Visszatérés a fő menübe **[MENÜ]** gomb
- Visszatérés az előző képernyőre **[VISSZA]** gomb

Funkcióbeállítások

Érintőpanel kalibrálása



Gomb műveletek

1



Válassza ki az „Érintőpanel” opciót a kezdeti beállítás menü menüben, majd nyomja meg a **VÁLASZT** gombot.

2

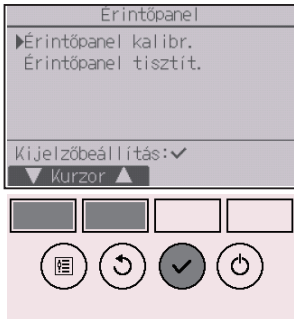

Vigye a kurzort az **F1** vagy **F2** gombokkal az „Érintőpanel kalibr.” opcióra, majd nyomja meg a **VÁLASZT** gombot.

3



Megjelenik egy jóváhagyó képernyő. Válassza a „Mégse” vagy az „OK” opciót az **F3** vagy **F4** gombbal, majd nyomja meg a **VÁLASZT** gombot.

4

Érintse meg a fekete pontokat a megjelenésük sorrendjében. Összesen kilenc van.

Érintse meg a fekete pontokat a egy érintőtollal, a felső bal sarokból kezdve.

Érintse meg a kilenc fekete pontot megjelenésük sorrendjében.

A kilenc fekete pont megérintése után a kalibrálás lezárult, és a kijelző visszatér az érintőpanel menüre.

- Ha az érintőpanelt egy percig nem érinti meg, a rendszer leállítja a kalibrálást, és a képernyő automatikusan visszaáll az előző képernyőre.
- Az érintőpanel megfelelő kalibrálásához a pontok érintésére egy hegyes, de nem éles tárgyat használjon.
 - * Az éles tárgyak kárt okozhatnak az érintőpanelben, vagy megkarcolhatják azt.

Funkcióbeállítások

Érintőpanel tisztítása



Gomb műveletek

1



Válassza ki az „Érintőpanel” opciót a kezdeti beállítás menü menüben, majd nyomja meg a **VÁLASZT** gombot.

2

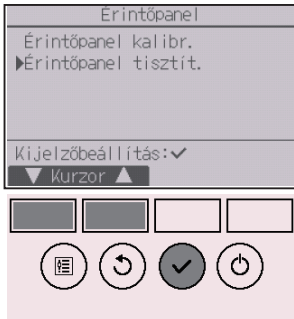

Vigye a kurzort az **F1** vagy **F2** gombokkal az „Érintőpanel tisztít.” opcióra, majd nyomja meg a **VÁLASZT** gombot.

3



Megjelenik egy jóváhagyó képernyő. Válassza a „Mégse” vagy az „OK” opciót az **F3** vagy **F4** gombbal, majd nyomja meg a **VÁLASZT** gombot.

4



A képernyő 30 másodpercig lehetővé teszi a felhasználó számára, hogy megtörölje az érintőpanelt anélkül, hogy véletlen elállítana valamit. A képernyő 30 másodperc múlva visszatér az érintőpanel menühöz.

- A törlést puha, száraz ronggyal, enyhe tisztítószeres vízzel áztatott ronggyal vagy etanollal nedvesített ronggyal végezze. Ne használjon savas, lúgos vagy szerves oldószereket.

Funkcióbeállítások

Távírányító alaphelyzetbe állítása



Funkció leírása

A távvezérlő gyári kiszállítási alaphelyzetbe állítható. A visszaállítás az alább felsorolt adatok érinti. A távvezérlő alaphelyzetbe állítás után automatikusan elindul.

Időzítő beállítása, heti időzítő beállítása, kültéri egység halk üzemmód beállítása, energiatakarékos beállítás, energiatakarékosság opció beállítása, óra beállítása, nyári időszámítás beállítása, fő kijelző beállítása, fényerő beállítása, kijelző részleteinek beállítása, megjelenés beállítása, Auto mód beállítása, modellnév beállítása, sorozatszám beállítása, kereskedői adatok beállítása, hibainformációk, adminisztrátori jelszó, karbantartási jelszó.

Gomb műveletek

1



Válassza ki az „Egyéb” opciót a szerviz menüben, majd nyomja meg a **VÁLASZT** gombot.

2



Vigye a kurzort az **F1** vagy **F2** gombokkal a „Távírányító alaphelyz. áll.” opcióra, majd nyomja meg a **VÁLASZT** gombot.

3

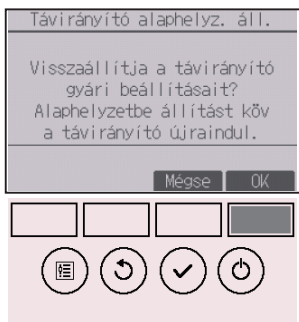

Válassza ki az „OK” opciót az **[F4]** gombbal.

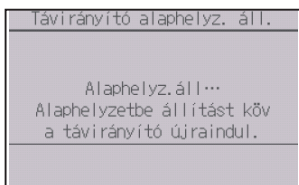

A távvezérlő alaphelyzetbe állítás után automatikusan elindul.

Funkcióbeállítások

Távirányító adatok



Funkció leírása

A használt távvezérlő információi itt ellenőrizhetők.

Gomb műveletek

1

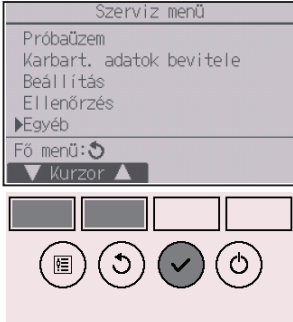

Válassza ki az „Egyéb” opciót a szerviz menüben, majd nyomja meg a **VÁLASZT** gombot.

2

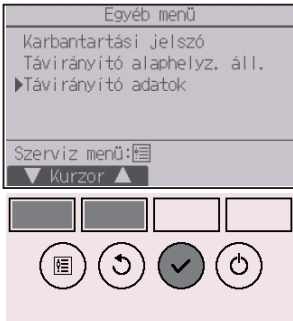

Vigye a kurzort az **F1** vagy **F2** gombokkal a „Távirányító adatok” opcióra, majd nyomja meg a **VÁLASZT** gombot.

3

Távirányító adatok	
Modellnév	
S/W Ver	00.10
Sorozatszám	

Vissza: ↶

☰

↶

✓

⏻

A használt távvezérlő modellneve, szoftververziója és sorozatszáma itt ellenőrizhető.

Hibaelhárítás

Hibainformációk

Ha hiba lép fel, az alábbi képernyő jelenik meg, és a művelet LED villogni kezd. Ellenőrizze a hiba státuszát, állítsa le az üzemeltetést és konzultáljon kereskedőjével.

Gomb műveletek

1



Megjelenik a hibakód, a hibaegység, a hűtőközeg címe, a modellnév, a hiba bekövetkeztének dátuma és ideje, valamint a sorozatszám.

A Modellnév és Sorozatszám csak akkor jelenik meg, ha ez az információ regisztrálva lett.

Nyomja meg az **[F1]** vagy **[F2]** gombot a következő oldalra ugráshoz.

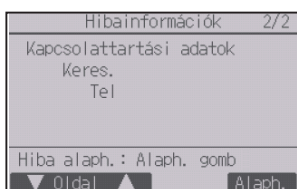

Megjelennek a kapcsolattartási adatok (kereskedő telefonszáma), ha az információ regisztrálva lett.

2



Nyomja meg az **[F4]** gombot vagy a **[BE/KI]** gombot a fellépő hiba visszaállításához.

Hibák nem állíthatók vissza, miközben a BE/KI művelet le van tiltva.



Válassza ki az „OK” opciót az **[F4]** gombbal.

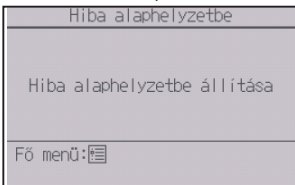

Megjelenik egy jóváhagyó képernyő.

Navigálás a képernyők között

- Visszatérés a fő menübe **[MENÜ]** gomb

Hibaelhárítás

Hiba információ ellenőrzése



Amikor nem áll fenn hiba, a hibainformációk 2/2 oldala (lásd az 74. oldalt) megtekinthető a művelet menüben.

Válassza ki a „Karbantartás menü” opciót a fő menüben, majd nyomja meg a **VÁLASZT** gombot.

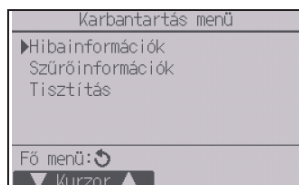

A hibainformációk képernyő megjelenítéséhez válassza a karbantartás menüben a „Hibainformációk” opciót.

A hibák nem állíthatók alaphelyzetbe.

Nem használt szoba Auto Ki

A következő képernyő jelenik meg a 3D i-See sensor panellal rendelkező típusok esetén, ha az egység leáll az Energiatakarékosság opció Nem használt szoba Auto Ki funkciója miatt.

Tekintse át a Használati Útmutatót a 3D i-See sensor beállításához.

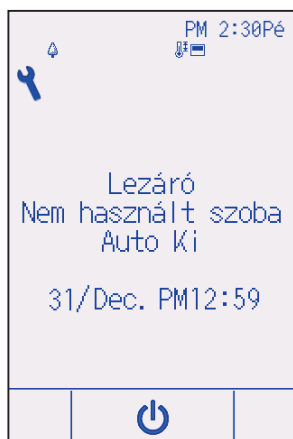

Karbantartás

Szűrőinformációk



 jelenik meg az állapotkijelzőn és a fő kijelzőn teljes módban, amikor ideje kitisztítani a szűrőket.

Mossa meg, tisztítsa ki, vagy cserélje ki a szűrőket, amikor ez a jel jelenik meg.

Lásd a beltéri egység használati útmutatóját.

Gomb műveletek

1



Válassza ki a „Szűrőinformációk” opciót a karbantartási menüben, majd nyomja meg a **VÁLASZT** gombot.

2

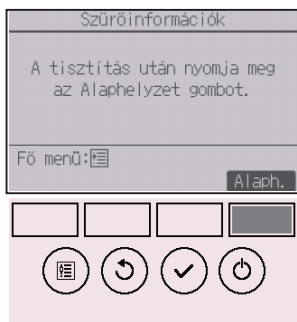

Nyomja meg az **F4** gombot a szűrő jel visszaállításához.

Lásd a beltéri egység használati útmutatóját a szűrő tisztítását illetően.

3



Válassza ki az „OK” opciót az [F4] gombbal.

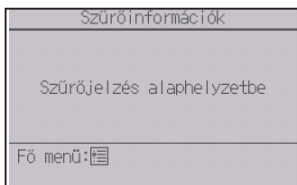

Megjelenik egy jóváhagyó képernyő.

Navigálás a képernyők között

- Visszatérés a fő menübe [MENU] gomb
- Visszatérés az előző képernyőre [VISSZA] gomb



Amikor  jelenik meg az állapotkijelzőn és a fő kijelzőn teljes módban, a rendszer központilag vezérelt, és a szűrő jelet nem lehet visszaállítani.

Ha két vagy több beltéri egység van csatlakoztatva, a szűrőtisztítás időzítése egységenként, a szűrő típusától függően eltérő lehet.

A  ikon jelenik meg, amikor a fő egység szűrőjét tisztítani kell.

Amikor a szűrő jel vissza van állítva, az összüzemi idő is visszaállításra kerül minden egység esetében.

A  ikon úgy van ütemezve, hogy egy bizonyos üzemidő elteltével a beltéri egységek telepítési helyének levegőminőségétől függően jelenjen meg. A levegő minőségétől függően, a szűrő elképzelhető, hogy gyakoribb tisztítást igényel.

Az összüzemi idő, ami után a szűrő tisztítást igényel, a modelltől függ.

Műszaki adatok

Vezérlő műszaki adatai

	Műszaki adatok
Termék mérete	Standard (PAR-CT01MAA(R)-SB/PAR-CT01MAA-S): 65(Sz) × 120(Ma) × 14,1(Mé) mm (2 9/16 × 4 23/32 × 9/16 [in]) (a kiugró részt nem számolva)
	Premium (PAR-CT01MAA(R)-PB): 68(Sz) × 120(Ma) × 14,1(Mé) mm (2 11/16 × 4 23/32 × 9/16 [in]) (a kiugró részt nem számolva)
Nettó súly	Standard (PAR-CT01MAA(R)-SB/PAR-CT01MAA-S): 0,09 kg (13/64 lbs)
	Premium (PAR-CT01MAA(R)-PB): 0,10 kg (7/32 lbs)
Névleges tápfeszültség	12 VDC (a beltéri egységekről)
Áramfogyasztás	0,6 W
Használati környezet	Hőmérséklet 0 ~ 40°C (32 ~ 104°F) Páratartalom 25 ~ 90% RH (harmat lecsapódás nélkül)
Anyag	Standard (PAR-CT01MAA(R)-SB/PAR-CT01MAA-S) Fő test: ABS
	Premium (PAR-CT01MAA(R)-PB) Fő test: ABS Oldallemez: alumínium

Funkciólista (2017. október 1-től érvényes)

○ : Támogatott × : Nem támogatott

	Funkció	CITY MULTI	Mr. SLIM	Szükséges jelszó
Teljesítmény	Teljesítmény BE/KI	○	○	-
Beállítások	Üzem mód	○	○	-
	Auto (duális beállítási pont) mód	○	○	-
	Előre beállított hőmérséklet	○	○	-
	Ventilátorsebesség	○	○	-
	Terelő	○	○	-
	Zsalu	○	○	-
	Ventiláció	○	○	-
Művelet menü	Nagy teljesítmény	×	○	-
	Terelőlap manuális szöge	○	○	-
	3D i-See sensor	○	○	-
Időzítő menü	Időzítő (Időzítő be/ki)	○	○	adminisztrátor
	Időzítő (Auto kikapcsolás időzítő)	○	○	adminisztrátor
	Heti időzítő	○	○	adminisztrátor
	Kültéri egység halk üzem mód	○	○	adminisztrátor
	Éjszakai csökkentett üzem mód	○	○	adminisztrátor
Energiatakarékos menü	Hőmérséklet-tartomány korlátozás	○	○	adminisztrátor
	Művelet lezárása funkció	○	○	adminisztrátor
	Auto vissza	○	○	adminisztrátor
	Ütemezés	×	○	adminisztrátor
Kezdeti beállítás menü	Óra	○	○	adminisztrátor
	Órakijelző formátum beállítás	○	○	adminisztrátor
	Nyári időszámítás	○	○	adminisztrátor
	Fő kijelző	○	○	adminisztrátor
	Ikonok magyarázata	○	○	adminisztrátor
	Fényerő	○	○	adminisztrátor
	Nyelvválasztás	○	○	adminisztrátor
	Megjelenés	○	○	adminisztrátor
	Érintőpanel kalibrálása	○	○	adminisztrátor
	Érintőpanel tisztítása	○	○	adminisztrátor
Jelszó (adminisztrátori)	○	○	adminisztrátor	
Szerviz menü	Távírányító alaphelyzetbe állítása	○	○	karbantartás
	Távírányító adatok	○	○	karbantartás
	Próbaüzem	○	○	karbantartás
	Modelladatok bevétele	○	○	karbantartás
	Kereskedői adatok bevétele	○	○	karbantartás
	Funkcióbeállítás	○	○	karbantartás
	Egyszerű karbantartás	×	○	karbantartás
	Jelszó (karbantartási)	○	○	karbantartás
Karbantartás menü	Auto terelőlemez	○	○	-
	Hibainformációk	○	○	-
	Szűrőinformációk	○	○	-

* A támogatott funkciók az egység modellől függenek.

Műszaki adatok

Az összes kombinálható/nem lehet kombinálható funkció listája

	Nagy teljesítmény	Időzítő be/ki	Auto kikapcsolás időzítő	Heti időzítő	Kültéri egység halk üzemmód	Hőmérséklet-tartomány	Művelet lezárása	Auto vissza	Energiatakarékos ütemezés	Éjszakai csökkentett üzemmód
Nagy teljesítmény		○	○	○	△ 1	○	△ 2	○	△ 1	○
Időzítő be/ki	○		○	× 1	○	○	○	○	○	△ 3
Auto kikapcsolás időzítő	○	○		○	○	○	○	○	○	△ 4
Heti időzítő	○	× 1	○		○	○	○	○	○	△ 5
Kültéri egység halk üzemmód	△ 1	○	○	○		○	○	○	○	○
Hőmérséklet-tartomány	○	○	○	○	○		○	× 2	○	△ 6
Művelet lezárása	△ 2	○	○	○	○	○		○	○	○
Auto vissza	○	○	○	○	○	× 2	○		○	△ 7
Energiatakarékos ütemezés	△ 1	○	○	○	○	○	○	○		○
Éjszakai csökkentett üzemmód	○	△ 3	△ 4	△ 5	○	△ 6	○	△ 7	○	

○ : Kombinálható × : Nem kombinálható △ : Letiltott

△ 1: a funkció a nagy teljesítményű üzemmód befejezése után kerül engedélyezésre, mivel a nagy teljesítményű üzemmód prioritást élvez.

△ 2: a funkció nem érhető el, amennyiben valamelyik üzemi zár aktiválva van.

△ 3: az éjszakai csökkentett funkció nem használható, amikor az egység az időzítő be/ki beállítás alatt működik.

△ 4: az Auto kikapcsolási funkció nem használható éjszakai csökkentett üzemhez.

△ 5: az éjszakai csökkentett funkció nem használható, amikor az egység a heti időkapcsoló beállítás alatt működik.

△ 6: a hőmérséklet-tartomány beállítása nem használható éjszakai csökkentett üzemhez.

△ 7: az Auto visszaállítási funkció nem használható éjszakai csökkentett üzemhez.

× 1: a heti időkapcsoló beállítás nem lép életbe, mert a be/ki időzítőnek magasabb a prioritása.

× 2: az Auto visszaállítási funkció nem használható, mivel a hőmérséklet-tartomány beállításnak magasabb a prioritása.

System sterowania CITY MULTI
i klimatyzatory Mr. SLIM firmy Mitsubishi

Dotykowy sterownik zdalny MA

PAR-CT01MAA-PB

PAR-CT01MAA-SB

PAR-CT01MAA-S

PAR-CT01MAR-PB

PAR-CT01MAR-SB

Instrukcja obsługi

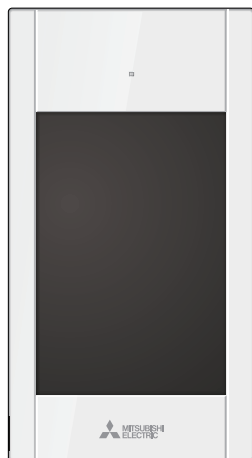

Polski

Przed rozpoczęciem pracy z urządzeniem należy dokładnie zapoznać się z instrukcją obsługi. Instrukcję należy zachować.

Płyta CD-ROM oraz instrukcja instalacji powinny zostać przekazane przyszłym użytkownikom urządzenia.



Zdalny sterownik powinien zostać zainstalowany przez wykwalifikowany personel, zapewni to jego prawidłową i bezpieczną pracę.

Spis treści

Środki bezpieczeństwa	4
Elementy sterownika	6
Interfejs sterownika – ekran statusu/ekran główny	6
Interfejs sterownika – ekran menu	8
Ekran – ekran statusu/ekran główny	10
Struktura menu i ikony	12
Struktura menu	12
Objaśnienia dotyczące ikon	15
Główne funkcje	16
WŁĄCZENIE/WYŁĄCZENIE zasilania	16
Ustawienia trybu działania, temperatury, prędkości wentylatora, kąta, żaluzji i wentylacji (Lossnay)	17
Poruszanie się po menu	22
Lista menu głównego	22
Poruszanie się po menu głównym	24
Ustawienia funkcji	25
Duża moc	25
Ręczny kąt żaluzji	26
Timer (Programator Włączania/Wyłączania)	29
Timer (Programator automatycznego wyłączenia)	32
Programator tygodniowy	34
Tryb cichy jednostki zewnętrznej	37
Nastawa nocna	40
Restrykcja	43
Oszczędzanie energii	49
Zegar	54
Czas letni	56
Ekran główny	58
Objaśnienia dotyczące ikon	59
Jasność	61
Wybór języka	62
Wzór	64
Kalibracja panelu dotykowego	66
Czyszczenie panelu dotykowego	68
Uruchamianie pilota	70
Informacje o zdalnym pilocie	72
Rozwiązywanie problemów	74
Informacje o błędzie	74
Nieobecność, automatyczne wyłączenie	77
Konserwacja	78
Informacje o filtrze	78
Dane techniczne	80
Dane techniczne sterownika	80
Lista funkcji (wg stanu na 1 października 2017)	81
Lista funkcji, które mogą/nie mogą być używane jednocześnie	82

Środki bezpieczeństwa

- Przed rozpoczęciem korzystania z urządzenia należy dokładnie zapoznać się z poniższymi środkami bezpieczeństwa.
- W celu zapewnienia bezpieczeństwa należy przestrzegać tych środków.

 OSTRZEŻENIE	Wskazuje ryzyko poważnych obrażeń ciała lub śmierci.
 PRZESTROGA	Wskazuje ryzyko poważnych obrażeń ciała lub uszkodzenia konstrukcji.

- Po przeczytaniu tej instrukcji należy ją przekazać użytkownikowi końcowemu w celu wykorzystania jej w przyszłości.
- Należy zachować tę instrukcję w celu wykorzystania jej w przyszłości i korzystać z niej w razie potrzeby. Instrukcja powinna być udostępniana osobom, które zajmują się naprawą lub zmianą miejsca instalacji sterownika. Instrukcję należy także przekazać przyszłym użytkownikom urządzenia.

Ogólne środki ostrożności

OSTRZEŻENIE

Nie wolno instalować urządzenia w miejscu, w którym występuje duża ilość oleju, pary, rozpuszczalników organicznych lub żrących gazów, jak np. opar siarkowy, lub tam, gdzie są często używane lub rozpylane roztwory kwasów/zasad. Substancje te mogą obniżyć wydajność urządzenia lub spowodować korozję jego elementów, co z kolei może być przyczyną porażenia elektrycznego, usterki, dymienia lub pożaru.

Aby zredukować ryzyko zwarcia, upływu prądu, porażenia elektrycznego, wystąpienia usterek, dymienia lub pożaru, nie wolno myć sterownika wodą ani roztworem cieczy.

Aby zredukować ryzyko porażenia elektrycznego, wystąpienia usterek, dymienia lub pożaru, nie wolno dotykać przycisków/przełączników sterownika lub dotykać jego części elektrycznych mokrymi rękami.

Podczas dezynfekcji urządzenia alkoholem należy zapewnić odpowiednią wentylację pomieszczenia. Opary alkoholu w pobliżu urządzenia mogą spowodować wybuch lub pożar w momencie włączenia urządzenia.

Aby zredukować ryzyko odniesienia obrażeń ciała lub porażenia elektrycznego, przed rozpoczęciem rozpylania substancji chemicznej w pobliżu sterownika należy wyłączyć go i przykryć osłoną.

Aby zredukować ryzyko odniesienia obrażeń ciała lub porażenia elektrycznego, przed rozpoczęciem czyszczenia, konserwowania lub kontrolowania sterownika należy wyłączyć go i odłączyć jego zasilanie.

W przypadku zauważenia jakichkolwiek nieprawidłowości (np. zapach spalenizny) należy wstrzymać pracę urządzenia, wyłączyć zasilanie i skontaktować się dystrybutorem. Dalsze korzystanie z urządzenia może być przyczyną porażenia elektrycznego, nieprawidłowego działania lub pożaru.

Należy poprawnie zainstalować wszystkie wymagane osłony, aby chronić sterownik przed wilgocią i pyłem. Nagromadzony pył i woda mogą być przyczyną porażenia elektrycznego, dymu lub pożaru.

PRZESTROGA

Aby zredukować ryzyko wystąpienia pożaru lub wybuchu, nie wolno umieszczać materiałów łatwopalnych lub używać aerozoli łatwopalnych w pobliżu sterownika.

Aby zredukować ryzyko uszkodzenia sterownika, nie wolno rozpylać bezpośrednio na niego środków do zwalczania owadów lub innych aerozoli łatwopalnych.

Aby zminimalizować ryzyko zanieczyszczenia środowiska, w celu utylizacji sterownika zdalnego należy skontaktować się z upoważnioną instytucją.

Aby zredukować ryzyko porażenia elektrycznego lub wystąpienia usterek, nie wolno dotykać panelu, przycisków lub przełączników ostrymi lub cienko zakończonymi przedmiotami.

Aby zredukować ryzyko odniesienia obrażeń ciała lub porażenia elektrycznego, nie należy dotykać ostrych krawędzi pewnych części.

Aby zredukować ryzyko odniesienia obrażeń ciała, należy zakładać środki ochrony osobistej podczas pracy ze sterownikiem.

Aby uniknąć skałeczenia rozbitym szkłem, nie wolno zbyt mocno naciskać szklanych części.

Środki ostrożności dotyczące przenoszenia lub naprawiania sterownika

OSTRZEŻENIE

Sterownik powinien być naprawiany lub przenoszony wyłącznie przez wykwalifikowany personel. Nie wolno demontować części lub modyfikować konstrukcji sterownika.

Nieprawidłowa instalacja lub naprawa mogą być przyczyną odniesienia obrażeń ciała, porażenia elektrycznego lub pożaru.

PRZESTROGA

Aby zredukować ryzyko zwarcia, porażenia elektrycznego, wystąpienia usterek lub pożaru, nie wolno dotykać obwodów drukowanych narzędziami lub rękami. Nie wolno także dopuścić do gromadzenia się pyłu na obwodach drukowanych.

Dodatkowe środki ostrożności

Aby uniknąć uszkodzenia sterownika, należy używać odpowiednich narzędzi do instalowania, sprawdzania lub naprawiania sterownika.

Ten sterownik może być używany wyłącznie z systemem zarządzania budynkiem (BMS) firmy Mitsubishi Electric. Zastosowanie tego sterownika w innym systemie lub do innego celu może być przyczyną usterek.

Urządzenie nie jest przeznaczone do obsługi przez osoby (także dzieci) o ograniczonej sprawności fizycznej, sensorycznej lub umysłowej, czy też osoby nie posiadające odpowiedniego doświadczenia lub wiedzy, chyba że obsługa taka odbywa się pod nadzorem lub według wskazówek opiekuna takiej osoby.

Należy dopilnować, aby dzieci nie bawiły się urządzeniem.

Aby uniknąć odbarwienia, do czyszczenia sterownika nie wolno używać benzenu, rozpuszczalnika ani chusteczek nasączonych substancjami chemicznymi. Aby wyczyścić sterownik, należy przetrzeć go miękką ściereczką zwilżoną łagodnym detergentem, wytrzeć detergent wilgotną ściereczką i zetrzeć do sucha suchą ściereczką.

Aby uniknąć uszkodzenia sterownika, należy go zabezpieczyć przed elektrycznością statyczną.

Urządzenie przeznaczone jest do użytku przez doświadczonych lub przeszkolonych użytkowników w sklepach, w przemyśle lekkim oraz na farmach, albo do komercyjnego wykorzystania przez osoby bez doświadczenia.

Aby uniknąć zagrożenia, uszkodzony przewód zasilania powinien zostać wymieniony przez jego producenta, technika serwisowego lub podobne, odpowiednio przeszkolone w tym celu osoby.

Elementy sterownika

Interfejs sterownika – ekran statusu/ekran główny

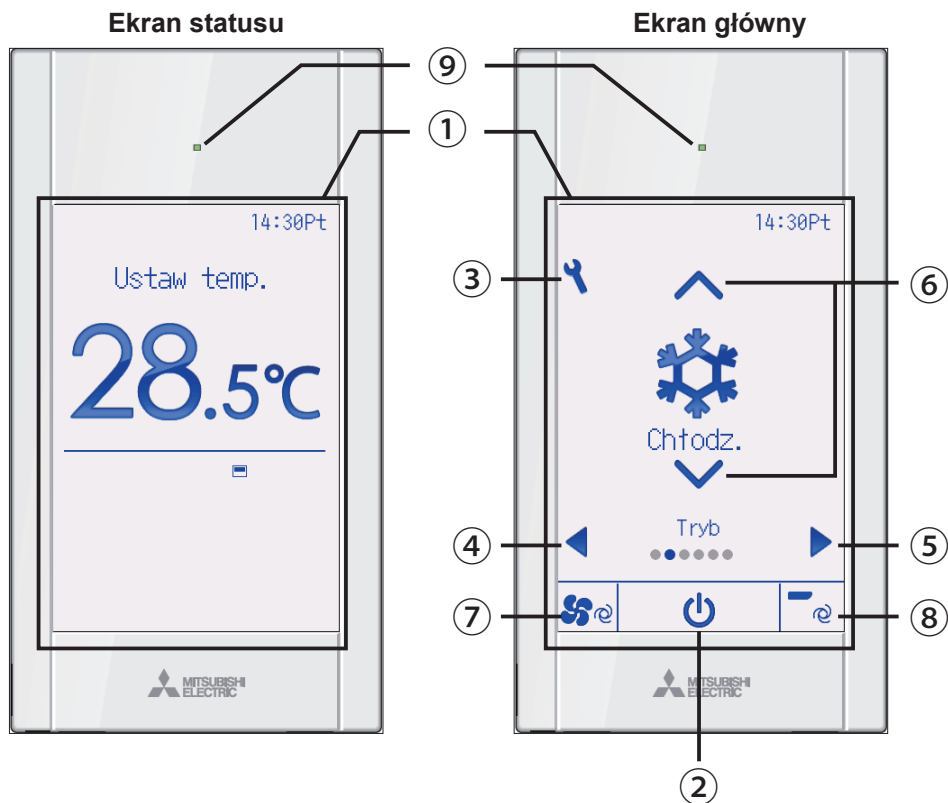

① Panel dotykowy i podświetlany kolorowy wyświetlacz LCD

Zostaną wyświetlone ustawienia operacji. Naciśnięcie dowolnego obszaru, gdy podświetlenie jest wyłączone, spowoduje powrót do ekranu statusu. Naciśnięcie dowolnego obszaru przy wyświetlonym ekranie statusu spowoduje powrót do ekranu głównego.

② Przycisk **WŁ/WYŁ**

Naciśnij, aby włączyć/wyłączyć urządzenie.

③ Przycisk **Ustawień**

Naciśnij, aby wyświetlić menu główne. Jeśli działanie menu jest zablokowane, wymagane jest wprowadzenie hasła administratora.

④ Przycisk

Każde naciśnięcie tego przycisku powoduje wyświetlenie kolejno następujących ustawień: żaluzje, wentylacja, kąt, prędkość wentylatora, tryb działania i zadana temperatura.

⑤ Przycisk

Każde naciśnięcie tego przycisku powoduje wyświetlenie kolejno następujących ustawień: zadana temperatura, tryb działania, prędkość wentylatora, kąt, wentylacja i żaluzje.

⑥ Przyciski

Naciśnij, aby zmienić wartości ustawień wymienionych w punktach ④ i ⑤.

⑦ Skrót do ekranu regulacji prędkości wentylatora

Naciśnij, aby przejść do ekranu ustawień prędkości wentylatora.

⑧ Skrót do ekranu regulacji kąta łopatek

Naciśnij, aby przejść do ekranu ustawień kąta łopatek.

⑨ Lampka włączenia/wyłączenia

Podczas pracy urządzenia lampka świeci na zielono, o ile opcja „Światło LED” nie jest ustawiona na „Nie”. Podczas uruchamiania lub gdy wystąpi błąd, lampka miga.

Jeżeli operacja Wł/Wył jest niedostępna, przycisk ② nie będzie wyświetlany.

Jeżeli dane ustawienie zostało wywołane przyciskami ④ lub ⑤, a opcja Wł/Wył jest niedostępna dla wybranego ustawienia, przycisk nie będzie wyświetlany.

Jeżeli opcja regulacji prędkości wentylatora lub ustawienia kąta łopatek jest zablokowana, przyciski ⑦ lub ⑧ nie będą wyświetlane.

Zawartość ustawień nie może być zmieniona za pomocą przycisku ⑥, jeżeli dane ustawienie jest sterowane centralnie przez sterownik systemowy.

Elementy sterownika

Interfejs sterownika – ekran menu



1 Przycisk **WŁ/WYŁ**

Naciśnij, aby włączyć/wyłączyć urządzenie.

2 Przycisk **WYBIERZ**

Naciśnij, aby zachować ustawienie.

3 Przycisk **POWRÓT**

Naciśnij, aby przejść do poprzedniego ekranu.

Kiedy wyświetlone jest menu główne, naciśnięcie tego przycisku spowoduje przejście do ekranu statusu.

4 Przycisk **MENU** Strona 24

Naciśnij, aby wyświetlić menu główne.

5 Przycisk funkcji **F1**

Ekran menu: Funkcje przycisków różnią się w zależności od wyświetlanego ekranu.

6 Przycisk funkcji **F2**

Menu główne: Naciśnij, aby przesunąć kursor w lewo.

Ekran menu: Funkcje przycisków różnią się w zależności od wyświetlanego ekranu.

7 Przycisk funkcji **F3**

Menu główne: Naciśnij, aby przesunąć kursor w prawo.

Ekran menu: Funkcje przycisków różnią się w zależności od wyświetlanego ekranu.

8 Przycisk funkcji **F4**

Ekran menu: Funkcje przycisków różnią się w zależności od wyświetlanego ekranu.

Działania przycisków funkcyjnych jest różne w zależności od ekranu.

Objaśnienie działania przycisków na danym ekranie pojawia się na dole wyświetlacza.

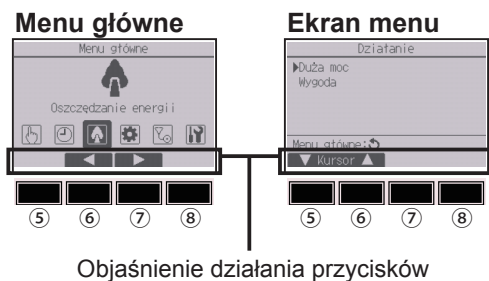

Elementy sterownika

Ekran – ekran statusu/ekran główny

Ekran statusu i ekran główny mogą być wyświetlane w dwóch różnych trybach: „Pełne” i „Podst.”.
Fabryczne ustawienie domyślne to „Pełne”. Przełączanie trybu zostało opisane na stronie 58.

Tryb pełny

* Ikony pokazane są w celach demonstracyjnych.

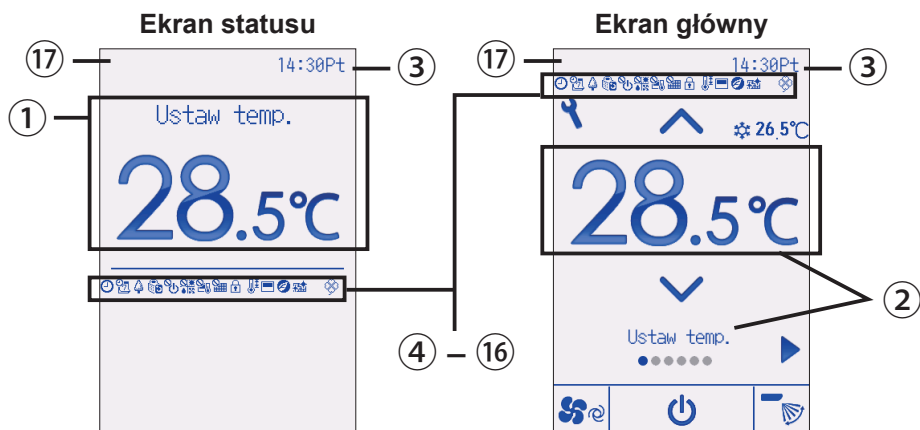

Tryb podstawowy

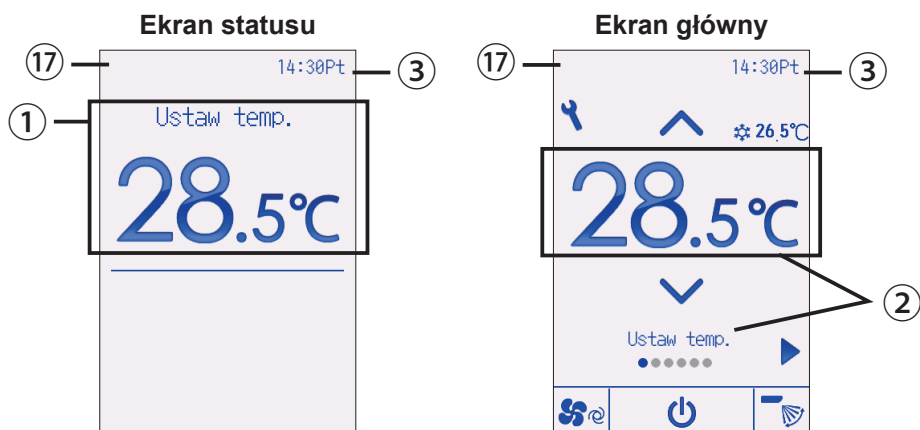

① Zadana temperatura lub temperatura pomieszczenia

Informacje o zadanej temperaturze lub temperaturze pomieszczenia wyświetlane są tutaj.
(Patrz Instrukcja instalacji).

② Elementy i zawartość ustawień Strona 17

Elementy „Zadana temperatura” ↔ „Tryb działania” ↔ „Prędkość wentylatora” ↔ „Kąt” ↔ „Wentylacja” ↔ „Żaluzje” i zawartość ich ustawień wyświetlane są tutaj. Informacja „Sterowanie centralne” pojawia się przez określony czas podczas obsługi elementu sterowanego centralnie.

③ Zegar

Wyświetlany jest tu aktualny czas.
(Patrz Instrukcja instalacji).

④ Strona 29, 32, 40

Pojawia się, gdy włączona jest funkcja programatora „Programator Włączania/ Wyłączania” (strona 29), „Nastawa nocna” (strona 40) lub „Programator automatycznego wyłączenia” (strona 32).

Jeśli programator zostanie wyłączony przez centralny system sterowania, pojawi się .

⑤ Strona 34

Pojawia się, gdy włączony jest Programator tygodniowy.

⑥ Strona 51

Pojawia się podczas pracy w trybie energooszczędnym. (Nie wyświetli się w przypadku niektórych modeli jednostek wewnętrznych)

⑦ Strona 37

Pojawia się podczas pracy jednostki zewnętrznej w trybie cichym.

⑧

Pojawia się, gdy operacja Wł/Wył jest sterowana centralnie.

⑨

Pojawia się, gdy tryb działania jest sterowany centralnie.

⑩

Pojawia się, gdy zadana temperatura są sterowane centralnie.

⑪

Pojawia się, gdy funkcja zerowania filtru jest sterowana centralnie.

⑫ Strona 46

Pojawia się, gdy przyciski są zablokowane.

⑬ Strona 43

Pojawia się, gdy zadany zakres temperatury jest ograniczony.

⑭

Pojawia się, gdy włączona jest funkcja monitorowania temperatury pomieszczenia przez termistor wbudowany w sterowniku zdalnym.

 pojawia się, gdy włączona jest funkcja monitorowania temperatury pomieszczenia przez termistor wbudowany w jednostce wewnętrznej.

⑮

Pojawia się, gdy włączona jest opcja oszczędzania energii przy wykorzystaniu funkcji „3D i-See sensor”.

⑯ Strona 78

Pojawia się, gdy wymagana jest konserwacja filtru.

⑰ Ekran błędów przed uruchomieniem

Po wykryciu błędu, który wystąpił przed uruchomieniem urządzenia, wyświetla się kod błędu.

Struktura menu i ikony

Struktura menu

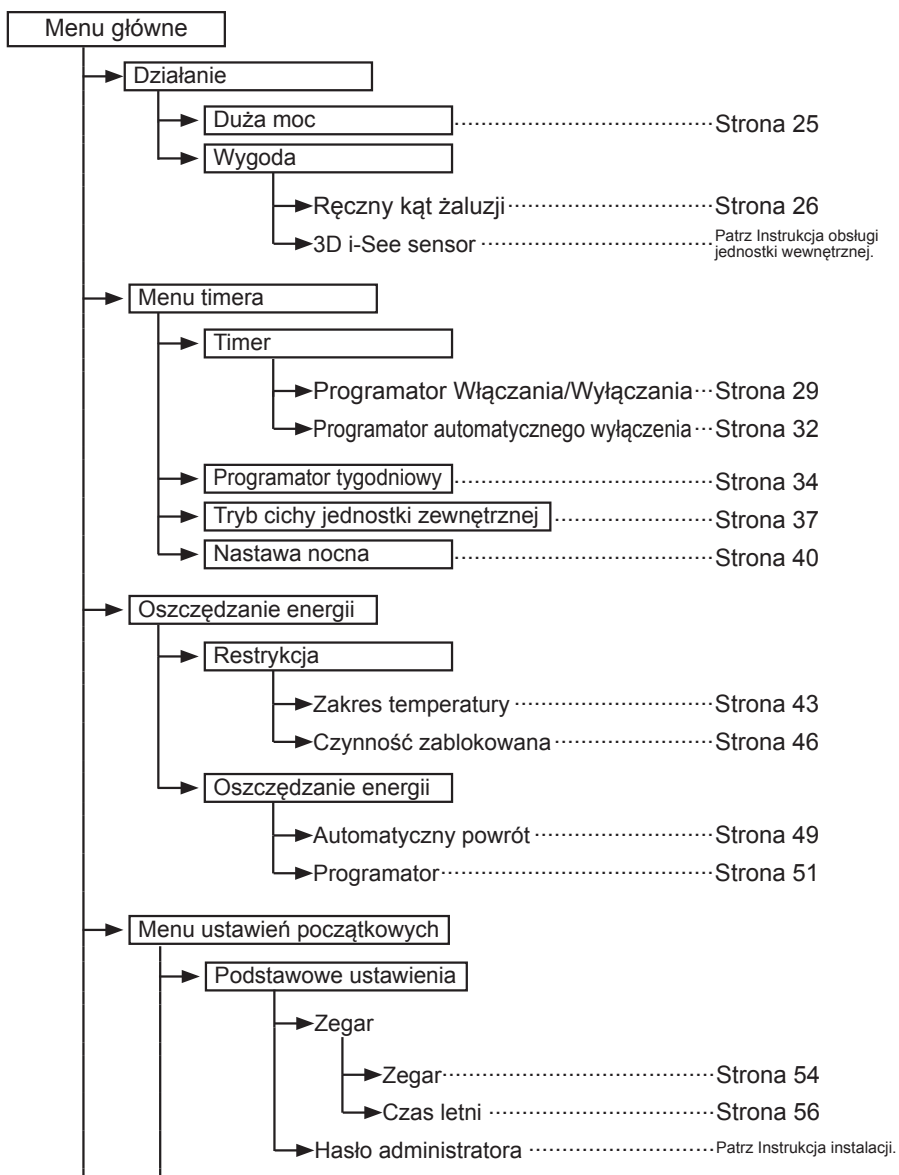

→	Ustawienia wyświetlacza	
	→ Ekran główny	Strona 58
	→ Szczegóły wyświetlacza (objaśnienia dotyczące ikon itp.)	Patrz Instrukcja instalacji.
	→ Jasność	Strona 61
	→ Wybór języka	Strona 62
	→ Wzór	Strona 64
→	Menu ustawień działania	
	→ Tryb Auto	Patrz Instrukcja instalacji.
→	Panel dotykowy	Strona 66
→	Menu konserwacji	
	→ Informacje o błędzie	Strona 74
	→ Informacje o filtrze	Strona 78
	→ Czyszczenie	
	→ Automatycznie opuszczany panel	Patrz Instrukcja obsługi dołączona do automatycznego panelu podnoszącego.
	→ Operacja opuszczania	Patrz Instrukcja obsługi dołączona do automatycznego panelu podnoszącego.
	→ Regulacja opuszczania	Patrz Instrukcja obsługi dołączona do automatycznego panelu podnoszącego.
→	Menu serwisowe	
	→ Menu uruchomienia testowego	
	→ Uruchomienie testowe	Patrz Instrukcja instalacji jednostki wewnętrznej.
	→ Uruchomienie testowe pompy	Patrz Instrukcja instalacji jednostki wewnętrznej.
	→ Informacje serwisowe	Patrz Instrukcja instalacji jednostki wewnętrznej.
	→ Wprowadzanie nazwy modelu	Patrz Instrukcja instalacji jednostki wewnętrznej.
	→ Wprowadzanie numeru seryjnego	Patrz Instrukcja instalacji jednostki wewnętrznej.
	→ Wprowadzanie informacji o Dostawcy	Patrz Instrukcja instalacji jednostki wewnętrznej.
	→ Inicjuj informacje serwisowe	Patrz Instrukcja instalacji jednostki wewnętrznej.

Struktura menu i ikony

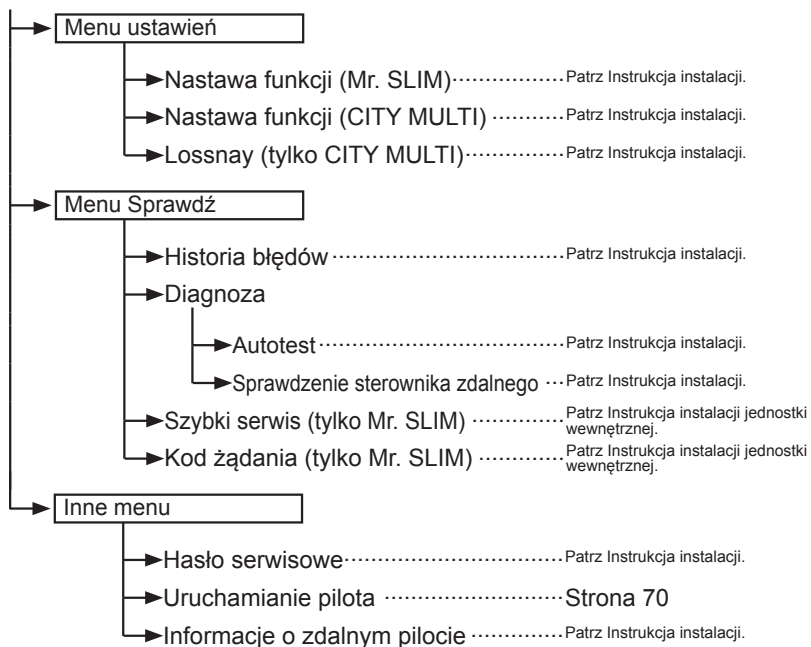

Nie wszystkie funkcje są dostępne w każdym modelu jednostki wewnętrznej.

Objaśnienia dotyczące ikon

Działanie sterownika

Timer



W poniższej tabeli znajdują się kwadratowe ikony użyte w tej instrukcji.



Aby zmieniać ustawienia, należy wprowadzić hasło administratora lub konserwatora na ekranie wprowadzania hasła. Nie można wprowadzić żadnych ustawień z pominięciem tego kroku.



F1 F2 F3 F4

- F1** : Naciśnij, aby przesunąć kursor w lewo.
- F2** : Naciśnij, aby przesunąć kursor w prawo.
- F3** : Naciśnij, aby zmniejszyć wartość o 1.
- F4** : Naciśnij, aby zwiększyć wartość o 1.

* Nie można dokonać zmian, dopóki nie zostanie wprowadzone prawidłowe hasło.



Wskazuje ustawienia, które mogą zostać zmienione tylko podczas pracy urządzeń.



Wskazuje ustawienia, które mogą zostać zmienione tylko, gdy urządzenia nie pracują.



Wskazuje ustawienia, które mogą zostać zmienione tylko, gdy urządzenia pracują w trybie Chłodzenie, Grzanie lub Auto.



Wskazuje funkcje, które nie są dostępne, gdy przyciski są zablokowane lub system jest centralnie sterowany.

Główne funkcje

WŁĄCZENIE/WYŁĄCZENIE zasilania



Obsługa za pomocą przycisków

Włącz



przycisk **WŁ/WYŁ**

Naciśnij przycisk **WŁ/WYŁ**.

Lampka włączenia/wyłączenia zaświeci się na zielono, urządzenie zacznie pracę.

Jeżeli dla ustawienia „Światło LED” została wybrana opcja „Nie”, lampka włączenia/wyłączenia nie zaświeci się.

Wyłącz



Naciśnij ponownie przycisk **WŁ/WYŁ**.

Lampka włączenia/wyłączenia zgaśnie, urządzenie zakończy pracę.

Ustawienia trybu działania, temperatury, prędkości wentylatora, kąta, żaluzji i wentylacji (Lossnay)



Obsługa za pomocą przycisków

Tryb działania



Każde naciśnięcie przycisków ▼ lub ▲ wyświetla kolejno następujące tryby działania.

Wybierz odpowiedni tryb działania.



Chłodzenie



Suszenie



Wentylator



Auto



Grzanie

- Tryby działania, które nie są dostępne dla podłączonej jednostki wewnętrznej, nie zostaną wyświetlone.

Co oznacza migająca ikona trybu

Ikona trybu miga, gdy inna jednostka wewnętrzna w tym samym układzie chłodzenia (przyłączona do tej samej jednostki zewnętrznej) działa w innym trybie. W takim wypadku pozostałe jednostki w grupie mogą być używane jedynie w tym samym trybie.

<Tryb Auto (podwójna wartość zadana)>

Jeśli tryb działania ustawiony jest na Auto (podwójna wartość zadana), można ustawić dwie temperatury (po jednej dla chłodzenia i grzania). W zależności od temperatury w pomieszczeniu jednostka wewnętrzna będzie automatycznie pracować w trybie Chłodzenie lub Grzanie i utrzymywać temperaturę w pomieszczeniu wewnątrz ustawionego zakresu temperatury.

Poniższy wykres pokazuje sposób działania jednostki wewnętrznej pracującej w trybie Auto (podwójna wartość zadana).

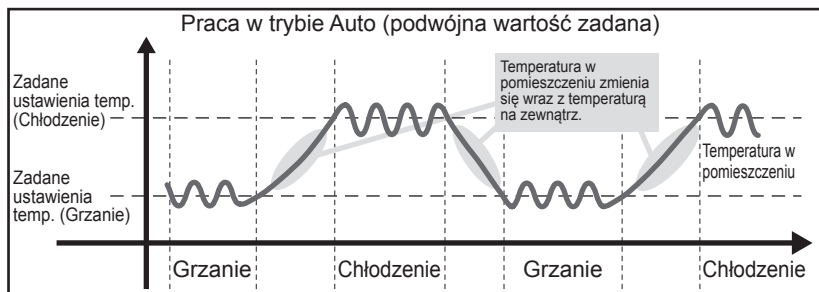



Główne funkcje

Zadana temperatura

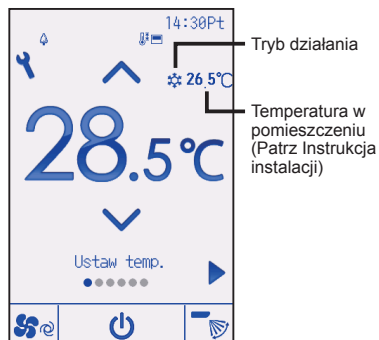
<Chłodzenie, Suszenie, Grzanie i Auto (pojedyncza wartość zadana)>





Naciśnij przycisk , aby zmniejszyć zadaną temperaturę, lub naciśnij przycisk , aby ją zwiększyć.

- Dostępne zakresy temperatury w różnych trybach działania są przedstawione w tabeli na stronie 19.
- Nie można ustawiać zadanego zakresu temperatury dla działania Wentylatora/Wentylacji.
- Zadana temperatura będzie wyświetlana w stopniach Celsjusza w odstępach co 0,5 stopnia lub co 1 stopień bądź w stopniach Fahrenheita, w zależności od modelu jednostki wewnętrznej oraz ustawionego na sterowniku trybu wyświetlacza.

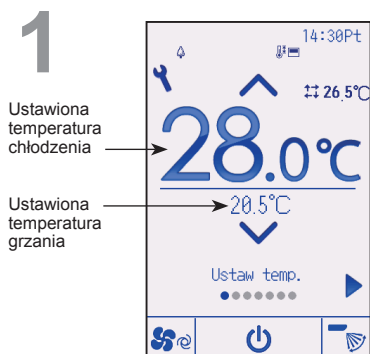
<Tryb Auto (podwójna wartość zadana)>





Zostaną wyświetlone bieżące zadane temperatury. Każde naciśnięcie przycisków  lub  zmienia zadane wartości temperatury dla chłodzenia i grzania.

2

Ustawiona temperatura chłodzenia

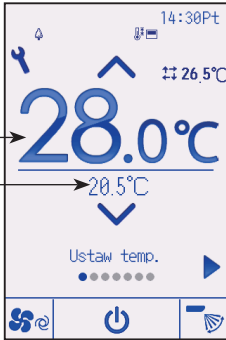
Ustawiona temperatura grzania



Naciśnij przycisk , aby zmniejszyć zadaną temperaturę, i naciśnij przycisk , aby ją zwiększyć.

- Poniższa tabela zawiera dostępne zakresy temperatury w różnych trybach działania.
- Ustawienia temperatury chłodzenia i grzania w trybie Auto (podwójna wartość zadana) są używane również w trybach Chłodzenie/Suszenie oraz Grzanie.
- Ustawione temperatury chłodzenia i grzania w trybie Auto (podwójna wartość zadana) należy ustawić tak, aby spełniały poniższe warunki:
 - Ustawiona temperatura chłodzenia jest wyższa niż ustawiona temperatura grzania.
 - Wymóg minimalnej różnicy temperatur pomiędzy ustawionymi temperaturami chłodzenia i grzania (różny w zależności od modelu podłączonej jednostki wewnętrznej) został spełniony.
 - Jeśli ustawione temperatury nie spełniają wymogu minimalnej różnicy temperatur, wtedy obydwie ustawione temperatury zostaną automatycznie zmienione na temperatury mieszczące się w dozwolonym zakresie.

Dostępny zadany zakres temperatury

Tryb działania	Zakres zadanych ustawień temperatury
Chłodzenie/Suszenie	19 ~ 30°C (67 ~ 87°F)
Grzanie	17 ~ 28°C (63 ~ 83°F)
Auto (Pojedyncza wartość zadana)	19 ~ 28°C (67 ~ 83°F)
Auto (Podwójna wartość zadana)	[Chłodzenie] Ustawiony zakres temperatury dla trybu Chłodzenia [Grzanie] Ustawiony zakres temperatury dla trybu Grzania
Wentylator/Wentylacja	Nieustawiane

Dostępny zadany zakres temperatury różni się w zależności od modelu jednostki wewnętrznej.

Główne funkcje

Prędkość wentylatora

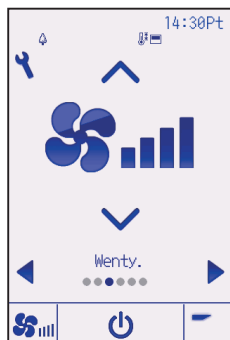

Każde naciśnięcie przycisków ▼ lub ▲ wyświetla kolejno następujące prędkości wentylatora.

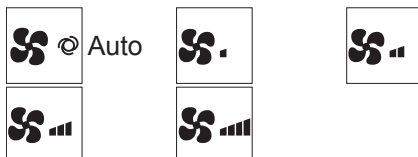

- Dostępne prędkości wentylatora zależą od modelu podłączonej jednostki wewnętrznej.

Ustawienia kątów łopatek



(Przykładowy ekran w CITY MULTI)

Każde naciśnięcie przycisków ▼ lub ▲ wyświetla kolejno następujące ustawienia łopatki.
Wybierz odpowiednie ustawienie.

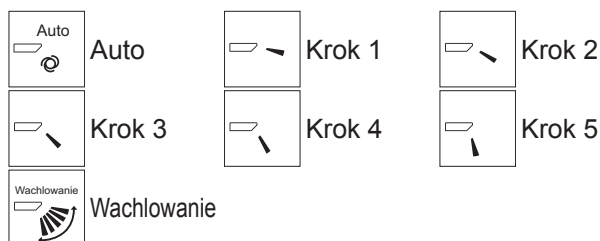

Wybranie opcji „Wachlowanie” spowoduje automatyczne podnoszenie się i opadanie łopatek.

Wybranie opcji „Krok 1” do „Krok 5” spowoduje ustawienie łopatki pod określonym kątem.

- **1h** po lewej stronie ikony ustawienia kąta łopatek
Ikona pojawi się, gdy łopatka ustawiona jest na krok 2, 3, 4 lub 5, natomiast prędkość wentylatora jest niska, podczas pracy w trybie chłodzenia lub suszenia (zależnie od modelu).
Ikona zniknie po godzinie, a ustawienia łopatki automatycznie zmienią się.

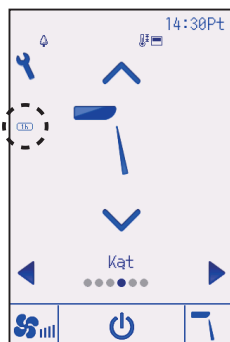

Ustawienia żaluzji

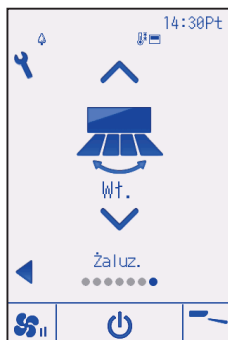

(Przykładowy ekran w CITY MULTI)

Aby włączyć lub wyłączyć wachlowanie żaluzji, należy nacisnąć przycisk ▼ lub ▲.



Wył.



Wł.

Ustawienia wentylacji

Ustawienia wentylacji mogą być zmieniane nawet podczas pracy urządzenia.



(Przykładowy ekran w Mr. SLIM)

Każde naciśnięcie przycisków ▼ lub ▲ wyświetla kolejno następujące ustawienia wentylacji.

* Ustawienie jest możliwe, gdy przyłączona jest jednostka Lossnay.



Wył.



Niska



Wysoka

• Wentylator w niektórych modelach jednostek wewnętrznych może być sprzężony z niektórymi modelami jednostek wentylacyjnych.

Poruszanie się po menu

Lista menu głównego

Menu główne	Elementy ustawień		Szczegóły ustawienia	Strona
Działanie	Duża moc		Użyj, aby szybko uzyskać komfortową temperaturę w pomieszczeniu. • Jednostki mogą pracować w trybie dużej mocy nie dłużej niż 30 minut.	25
	Wygoda	Ręczny kąt żaluzji	Pozwala na ustawienie kąta każdej żaluzji.	26
Timer	Timer	Programator Włączania/Wyłączania	Programowanie godziny włączania/wyłączania. • Wartość godziny można ustawić w odstępach co 5 minut. * Wymagane jest ustawienie zegara.	29
		Programator automatycznego wyłączenia	Ustawienie czasu automatycznego wyłączenia. • Czas można ustawić w zakresie od 30 do 240 minut w krokach co 10 minut.	32
	Programator tygodniowy		Programowanie godzin włączania/wyłączania w tygodniu. • Do każdego dnia można przypisać maksymalnie 8 schematów działania. • Możliwe jest zaprogramowanie dwóch tygodniowych nastaw: * Wymagane jest ustawienie zegara. * Nie dotyczy, gdy włączony jest Programator Włączania/Wyłączania. * Odstępy co 1°C	34
	Tryb cichy jednostki zewnętrznej		Ustawienie godzin, podczas których cicha praca jednostek zewnętrznych ma wyższy priorytet niż sterowanie temperaturą. Ustaw godzinę Start/Stop dla każdego dnia tygodnia. • Wybierz odpowiednie ustawienie poziomu głośności spośród „Norm.”, „Średni” lub „Cichy”. * Wymagane jest ustawienie zegara.	37
	Nastawa nocna		Wprowadzenie ustawień nocnych. • Wybierz „Tak”, aby włączyć ustawienie, lub „Nie”, aby je wyłączyć. Ustawienie zakresu temperatury oraz godziny początkowej/końcowej. * Wymagane jest ustawienie zegara. * Odstępy co 1°C	40
Oszczędzanie energii	Restrykcja	Zakres temperatury	Ograniczenie zadanego zakresu temperatury. • Dla różnych trybów działania można ustawić różne zakresy temperatury. * Odstępy co 1°C	43
		Czynność zablokowana	Zablokowanie wybranych funkcji. • Zablokowanych funkcji nie można używać.	46
	Oszczędzanie energii	Automatyczny powrót	Po upływie określonego czasu pracy w trybie energooszczędnym urządzenia powrócą do pracy w zadanym zakresie temperatury. • Czas można ustawić w zakresie od 30 do 120 minut w krokach co 10 minut. * Funkcja może nie być dostępna, gdy istnieją ograniczenia zadanego zakresu temperatury. * Odstępy co 1°C	49

Menu główne	Elementy ustawień		Szczegóły ustawienia	Strona
Oszczędzanie energii	Oszczędzanie energii	Programator	Ustawienie Start/Stop godziny pracy jednostek w trybie energooszczędnym w każdym dniu tygodnia oraz ustawienie poziomu oszczędności energii. <ul style="list-style-type: none"> • Do każdego dnia można przypisać maksymalnie 4 schematy pracy energooszczędnej. • Wartość godziny można ustawić w odstępach co 5 minut. • Poziom oszczędności energii można ustawić w zakresie: 0% i od 50 do 90% w krokach co 10%. * Wymagane jest ustawienie zegara.	51
Ustawienie początkowe	Podstawowe ustawienia	Zegar	Ustawienie bieżącego czasu.	54
		Czas letni	Służy do ustawiania czasu letniego.	56
	Ustawienia wyświetlacza	Ekran główny	Przełączanie pomiędzy trybami „Pełne” i „Podst.” na ekranie statusu i ekranie głównym. <ul style="list-style-type: none"> • Ustawieniem domyślnym jest „Pełne”. 	58
		Jasność	Pozwala na dopasowanie jasności ekranu.	61
		Wybór języka	Wybór odpowiedniego języka.	62
		Wzór	Pozwala na zmianę koloru ekranu statusu i ekranu głównego.	64
	Panel dotykowy	Kalibracja panelu dotykowego	Pozwala na zmianę ustawień kalibracji panelu dotykowego.	66
Czyszczenie panelu dotykowego		Tymczasowo wyłącza panel dotykowy, aby umożliwić jego czyszczenie.	68	
Serwis	Uruchamianie pilota	Pozwala na włączenie sterownika w stanie fabrycznym.	70	
	Informacje o zdalnym pilocie	Wyświetla nazwę modelu zdalnego sterownika, wersję jego oprogramowania i numer seryjny.	72	
Konserwacja	Informacje o błędzie	Sprawdzenie informacji o błędzie podczas wystąpienia błędu. <ul style="list-style-type: none"> • Wyświetlone mogą zostać: kod błędu, źródło błędu, lokalizacja układu chłodzącego, model jednostki, numer seryjny oraz informacje kontaktowe (numer telefonu dystrybutora). * Model jednostki, numer seryjny oraz informacje kontaktowe muszą najpierw zostać wprowadzone, aby można je było wyświetlić.	74	
	Informacje o filtrze	Kontrola stanu filtra. <ul style="list-style-type: none"> • Znak filtra można wyzerować. 	78	

Poruszanie się po menu

Poruszanie się po menu głównym

Obsługa za pomocą przycisków

Dostęp do menu głównego



Naciśnij przycisk **[Ustawień]** na ekranie głównym.

Pojawi się menu główne.

Wybór pozycji



Naciśnij **[F2]**, aby przesunąć kursor w lewo.

Naciśnij **[F3]**, aby przesunąć kursor w prawo.

Kursor

Ustawienia funkcji

Duża moc



Opis funkcji

Funkcja pracy w trybie zwiększonej wydajności umożliwia pracę urządzenia z wydajnością wyższą niż nominalna, tak aby umożliwić szybkie uzyskanie optymalnej temperatury w pomieszczeniu. Czas pracy w tym trybie wynosi maksymalnie 30 minut. Urządzenie powróci do normalnego trybu działania po upływie tego czasu lub w momencie osiągnięcia zadanej temperatury, w zależności od tego, co nastąpi wcześniej. Jednostki powrócą do normalnego trybu działania, gdy zmienione zostaną tryb działania lub prędkość wentylatora.

Obsługa za pomocą przycisków

1



Wybierz „Duża moc” z menu Działanie podczas pracy w trybie Chłodzenie, Grzanie lub Auto i naciśnij przycisk **WYBIERZ**.

Funkcja „Duża moc” jest dostępna tylko w modelach, które ją obsługują.

2



Przesuń kursor na pozycję „Tak” za pomocą przycisków **F3** lub **F4** i naciśnij przycisk **WYBIERZ**.

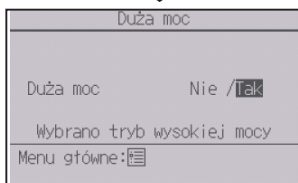

Pojawi się ekran z potwierdzeniem.

Poruszanie się po ekranach

- Powrót do menu głównego przycisk **MENU**
- Powrót do poprzedniego ekranu przycisk **POWRÓT**

Ustawienia funkcji

Ręczny kąt żaluzji

OFF

Obsługa za pomocą przycisków

1



Z menu Działanie wybierz „Wygoda” i naciśnij przycisk **WYBIERZ**.

2



Wybierz pozycję „Ręczny kąt żaluzji” za pomocą przycisków **F1** i **F2** i naciśnij przycisk **WYBIERZ**.

3

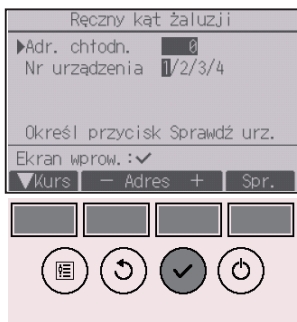

Przesuń kursor za pomocą przycisku [F1], aby wybrać spośród opcji: „Adr. chłodn.” oraz „Nr urządzenia”.

Za pomocą przycisków [F2] i [F3] wybierz adres układu chłodzącego oraz numery urządzeń, których żaluzje mają zostać ustawione, i naciśnij przycisk [WYBIERZ].

- Adr. chłodn.: Lokalizacja układu chłodzącego
- Nr urządzenia: 1, 2, 3, 4

Naciśnij przycisk [F4], aby zatwierdzić wybór urządzenia.

Po lewej pokazany jest przykładowy ekran dla urządzenia Mr. SLIM. W modelach CITY MULTI wyświetlany jest „Adres M-NET” zamiast „Adr. chłodn.”, a „Nr urządzenia” nie jest wyświetlany.

4

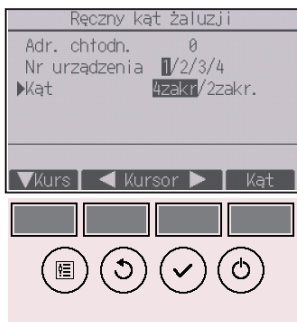

Wybierz „Kąt” za pomocą przycisku [F1].

Wybierz pozycję „4zakr.” lub „2zakr.” za pomocą przycisków [F2] i [F3] i naciśnij przycisk [F4].

Ustawienia funkcji

5

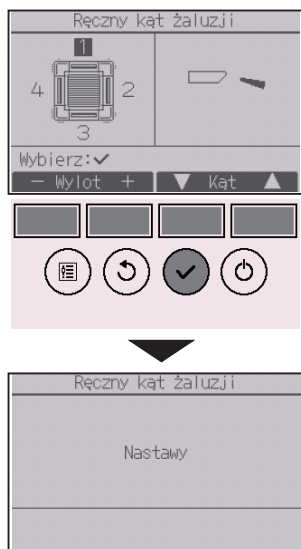

Zostaną wyświetlone bieżące ustawienia kąta łopatek.

Wybierz odpowiednie wyloty z dostępnych: „1”, „2”, „3”, „4” lub „1, 2, 3, 4 (wszystkie wyloty)” za pomocą przycisków [F1] i [F2].

Za pomocą przycisków [F3] lub [F4] przejdź do następujących opcji i wybierz pożądane ustawienie.

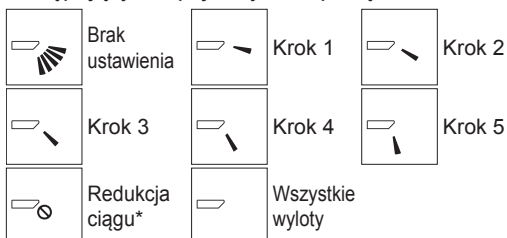

Naciśnij przycisk [WYBIERZ], aby zachować ustawienia. Pojawi się ekran informujący o przesyłaniu informacji dotyczących ustawień.

Zmiany zostaną dokonane na wybranym wylocie.

Ekran automatycznie powróci do poprzedniego ustawienia, gdy transmisja zostanie zakończona.

W ten sam sposób dokonuje się wyboru ustawień dla pozostałych wylotów.

Jeżeli wybrane są wszystkie wyloty, ikona  wyświetli się przy następnym rozpoczęciu pracy urządzenia.

Poruszanie się po ekranach

• Powrót do poprzedniego ekranu przycisk [POWRÓT]

*Redukcja ciągu

Tryb [Redukcja ciągu] utrzymuje kąt żaluzji bardziej poziomy niż kąt kroku 1, zatem strumień powietrza nie będzie nakierowany na osobę.

Ta funkcja może być ustawiona tylko dla jednego wylotu.

Ta funkcja nie może być ustawiona dla modeli z dwoma lub trzema wylotami.

W trybie Redukcja ciągu strumień powietrza może spowodować przebarwienie sufitu.

Timer (Programator Włączania/Wyłączania)



Obsługa za pomocą przycisków

1



Z menu głównego wybierz „Timer” (patrz strona 24) i naciśnij przycisk **WYBIERZ**.

Programator Włączania/Wyłączania nie działa w następujących przypadkach:

kiedy Programator Włączania/Wyłączania jest włączony, podczas wystąpienia błędu, podczas kontroli (w menu czynności obsługowych), podczas uruchomienia testowego, podczas zdalnej diagnostyki sterownika, jeżeli zegar nie jest ustawiony, podczas ustawiania funkcji, jeżeli system jest centralnie sterowany (kiedy obsługa funkcji Wł/Wył lub programator przy użyciu lokalnego sterownika są zabronione).

2



Przesuń kursor na pozycję „Timer” i naciśnij przycisk **WYBIERZ**.

3



Zostaną wyświetlone bieżące ustawienia.

Przesuń kursor na pozycję „Progr. Wł./Wył.” i naciśnij przycisk **WYBIERZ**.

Ustawienia funkcji

4



Pojawi się ekran, na którym można zmienić ustawienia programatora.

Za pomocą przycisków **[F1]** i **[F2]** wybierz odpowiednią pozycję spośród „Progr. Wł./Wyt.”, „Wł.”, „Wyt.” lub „Powtóż”.

5



Zmień ustawienie za pomocą przycisków **[F3]** i **[F4]**.

- Progr. Wł./Wyt.: Nie (wyłączony) / Tak (włączony)
- Wł.: Czas rozpoczęcia działania (ustawiany w krokach co 5 minut)
 - * Naciśnij i przytrzymaj, aby przyspieszyć wyświetlanie liczb.
- Wyt.: Czas zakończenia działania (ustawiany w krokach co 5 minut)
 - * Naciśnij i przytrzymaj, aby przyspieszyć wyświetlanie liczb.
- Powtóż: Nie (jednorazowo) / Tak (powtarzaj)

6



Naciśnij przycisk **WYBIERZ**, aby zachować ustawienia.





Pojawi się ekran z potwierdzeniem.

Poruszanie się po ekranach

- Powrót do menu głównego przycisk **MENU**
- Powrót do poprzedniego ekranu przycisk **POWRÓT**



Jeżeli programator Włączania/Wyłączania jest włączony, na ekranie statusu i ekranie głównym w trybie pełnym pojawi się  .

Jeśli programator zostanie wyłączony przez centralny system sterowania, pojawi się  .

Ustawienia funkcji

Timer (Programator automatycznego wyłączenia)



Obsługa za pomocą przycisków

1



Przejdź do ekranu ustawień timera.
(Patrz strona 29).

Wybierz pozycję „Auto. wyłączenie” i naciśnij przycisk **WYBIERZ**.

Programator automatycznego wyłączenia nie działa w następujących przypadkach:

kiedy Programator automatycznego wyłączenia jest wyłączony, podczas wystąpienia błędu, podczas kontroli (w menu czynności obsługowych), podczas uruchomienia testowego, podczas zdalnej diagnostyki sterownika, podczas ustawiania funkcji, jeżeli system jest centralnie sterowany (kiedy obsługa funkcji Wł/Wył lub programator przy użyciu lokalnego sterownika są zabronione).

2



Zostaną wyświetlone bieżące ustawienia.

Przesuń kursor na pozycję „Auto. wyłączenie” lub „Zatrzymaj za --- min” za pomocą przycisków **F1** i **F2**.

3



Zmień ustawienie za pomocą przycisków **F3** i **F4**.

- Auto. wyłączenie: Nie (wyłączony) / Tak (włączony)
- Zatrzymaj za --- min: Ustawienie timera (programowalny zakres wynosi od 30 do 240 minut, w odstępach co 10 minut).

4



Naciśnij przycisk **WYBIERZ**, aby zachować ustawienia.

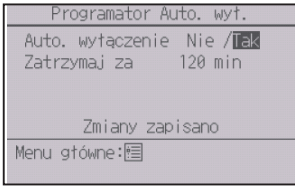



Pojawi się ekran z potwierdzeniem.

Poruszanie się po ekranach

- Powrót do menu głównego przycisk **MENU**
- Powrót do poprzedniego ekranu przycisk **POWROT**



Jeżeli programator automatycznego wyłączenia jest włączony, na ekranie statusu i ekranie głównym w trybie pełnym pojawi się .

Jeśli programator zostanie wyłączony przez centralny system sterowania, pojawi się .

Ustawienia funkcji

Programator tygodniowy



Obsługa za pomocą przycisków

1

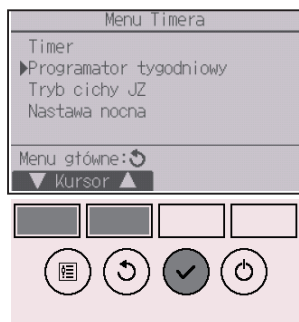

Z menu timera wybierz „Programator tygodniowy” i naciśnij przycisk **WYBIERZ**.

Programator tygodniowy nie działa w następujących przypadkach:

kiedy Programator Włączania/Wyłączania jest włączony, kiedy programator tygodniowy jest wyłączony, podczas wystąpienia błędu, podczas kontroli (w menu czynności obsługowych), podczas uruchomienia testowego, podczas zdalnej diagnostyki sterownika, jeżeli zegar nie jest ustawiony, podczas ustawiania funkcji, jeżeli system jest centralnie sterowany (kiedy ustawianie temperatury i obsługa funkcji Wł/Wył lub programator przy użyciu lokalnego sterownika są zabronione).

2



Zostaną wyświetlone bieżące ustawienia.

Użyj przycisków **F1** i **F2**, aby wyświetlić ustawienia dla każdego dnia tygodnia.

Za pomocą przycisku **F3** wyświetl schematy od 5 do 8.

Naciśnij przycisk **F4**, aby wyświetlić status ustawienia 2.

Naciśnij przycisk **WYBIERZ**, aby przejść do ekranu z ustawieniami.

3

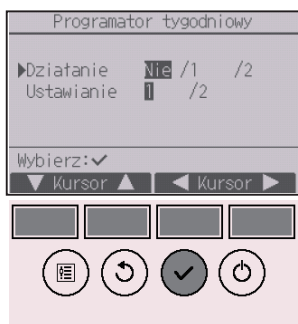

Pojawi się ekran z ustawieniami programatora tygodniowego.

W elemencie „Działanie” za pomocą przycisków **[F3]** lub **[F4]** wybierz „1”, aby włączyć ustawienie programatora 1, lub „2”, aby włączyć ustawienie programatora 2. Następnie naciśnij przycisk **[WYBIERZ]**.

Aby wyświetlić zawartość ustawień programatora 1 lub 2, przesunij kursor do opcji „Ustawienie” za pomocą przycisków **[F1]** lub **[F2]** i wybierz „1” lub „2” za pomocą przycisków **[F3]** lub **[F4]**.

4



Pojawi się ekran z ustawieniami programatora tygodniowego, wyświetlone zostaną aktualne ustawienia.

Do każdego dnia można przypisać maksymalnie 8 schematów działania.

Przesunij kursor na odpowiedni dzień tygodnia za pomocą przycisków **[F1]** i **[F2]** i naciśnij przycisk **[F3]**, aby dokonać wyboru. (Można zaznaczyć kilka dni).

Naciśnij przycisk **[WYBIERZ]**.

Ustawienia funkcji

5

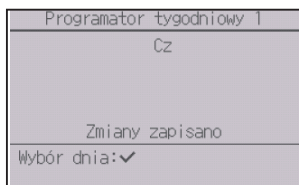

Zostaną wyświetlone ustawienia schematów działania.

Przesuń kursor za pomocą przycisku [F1] na odpowiedni numer schematu działania.

Przesuń kursor na pozycję Czas, Wł./Wył. lub Temperatura za pomocą przycisku [F2].

Zmień ustawienie za pomocą przycisków [F3] i [F4].

- Czas: ustawiany w krokach co 5 minut
 - * Naciśnij i przytrzymaj, aby przyspieszyć wyświetlanie liczb.
- Wł./Wył./Auto: Możliwe do wyboru ustawienia zależą od podłączonego modelu jednostki wewnętrznej. (Kiedy wybrane jest ustawienie Auto, system będzie pracował w trybie Auto (podwójna wartość zadana)).
- Temperatura: Dostępny zakres temperatury zależy od przyłączonej jednostki wewnętrznej. (odstępny co 1°C) Można ustawić dwie temperatury, gdy wybrany jest tryb Auto (podwójna wartość zadana). Jeśli urządzenie pracuje z jedną ustawioną temperaturą w trybie Auto (podwójna wartość zadana), temperatura ta będzie używana jako ustawiona temperatura chłodzenia w trybie Chłodzenie.

Naciśnij przycisk [WYBIERZ], aby zachować ustawienia.

Pojawi się ekran z potwierdzeniem.

Poruszanie się po ekranach

- Powrót do zmiany ustawień/ekranu wyboru dni tygodnia przycisk [WYBIERZ]
- Powrót do menu głównego przycisk [MENU]
- Powrót do poprzedniego ekranu przycisk [POWRÓT]



 pojawi się na ekranie statusu i ekranie głównym w trybie pełnym, jeżeli istnieją ustawienia programatora tygodniowego na bieżący dzień. Ikona nie zostanie wyświetlona, gdy Programator Włączania/Wyłączania jest włączony lub gdy system sterowany jest centralnie (obsługa funkcji „Timer” z lokalnego sterownika jest niedozwolona).

Opis funkcji

Funkcja pozwala na ustawienie godzin, podczas których cicha praca jednostek zewnętrznych ma wyższy priorytet niż sterowanie temperaturą. Ustaw godzinę początkową/kończącą trybu cichej pracy dla każdego dnia tygodnia. Wybierz odpowiednie ustawienie poziomu głośności spośród: „Średni” lub „Cichy”.

Obsługa za pomocą przycisków

1



Z menu timera wybierz „Tryb cichy JZ” i naciśnij przycisk **WYBIERZ**.

Funkcja „Tryb cichy JZ” jest dostępna tylko w modelach, które ją obsługują.

2



Zostaną wyświetlone bieżące ustawienia.

Użyj przycisków **F1** i **F2**, aby wyświetlić ustawienia dla każdego dnia tygodnia.

Naciśnij przycisk **WYBIERZ**, aby przejść do ekranu z ustawieniami.

Ustawienia funkcji

3



Pojawi się ekran, na którym można włączyć (Tak) lub wyłączyć (Nie) tryb cichej pracy.

Aby włączyć tę funkcję, przesunij kursor na pozycję „Tak” za pomocą przycisków **[F3]** i **[F4]** i naciśnij przycisk **[WYBIERZ]**.

4



Zostaną wyświetlone ustawienia Tryb cichy jednostki zewnętrznej.

Aby zmienić ustawienia, przesunij kursor na odpowiedni dzień tygodnia za pomocą przycisków **[F1]** i **[F2]** i naciśnij przycisk **[F3]**, aby dokonać wyboru. (Można zaznaczyć kilka dni).

Naciśnij przycisk **[WYBIERZ]**.

5

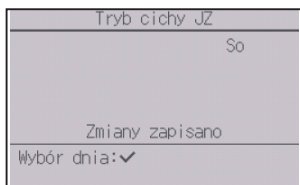

Zostanie wyświetlony ekran z ustawieniami.

Przesuń kursor na odpowiednią pozycję za pomocą przycisków **[F1]** lub **[F2]**, aby ustawić Start, Stop i Poziom głośności.

Zmień ustawienie za pomocą przycisków **[F3]** i **[F4]**.

- Start/Stop: ustawiany w krokach co 5 minut
 - * Naciśnij i przytrzymaj, aby przyspieszyć wyświetlanie liczb.
- Poziom głośności: Normalny, Średni, Cichy



Normalny



Średni



Cichy

Naciśnij przycisk **[WYBIERZ]**, aby zachować ustawienia. Pojawi się ekran z potwierdzeniem.

Poruszanie się po ekranach

- Powrót do zmiany ustawień/ekranu wyboru dni tygodnia przycisk **[WYBIERZ]**
- Powrót do menu głównego przycisk **[MENU]**
- Powrót do poprzedniego ekranu przycisk **[POWRÓT]**



W trybie Cichy jednostki zewnętrznej na ekranie statusu i ekranie głównym w trybie pełnym pojawi się .

Ustawienia funkcji

Nastawa nocna



Opis funkcji

To ustawienie powoduje uruchomienie funkcji grzania, gdy sterowanie grupowe jest wyłączone, a temperatura pomieszczenia spada poniżej zadanej dolnej temperatury granicznej. Ponadto to ustawienie powoduje uruchomienie funkcji chłodzenia, gdy sterowanie grupowe jest wyłączone, a temperatura pomieszczenia wzrasta powyżej zadanej górnej temperatury granicznej. Funkcja Nastawa nocna nie jest dostępna, jeżeli ustawienia temperatury dokonywane są za pomocą sterownika zdalnego.

Jeżeli temperatura pomieszczenia jest mierzona za pomocą czujnika temperatury w układzie zasysania, otrzymany rezultat może nie być dokładny, gdy urządzenie nie pracuje lub powietrze jest zanieczyszczone. W takim wypadku należy przełączyć odczyt na czujnik zdalny (PAC-SE40TSA/ PAC-SE41TS-E) lub czujnik sterownika zdalnego.

Obsługa za pomocą przycisków

1



Z menu timera wybierz „Nastawa nocna” i naciśnij przycisk **WYBIERZ**.

2



Zostaną wyświetlone bieżące ustawienia.

Naciśnij przycisk **WYBIERZ**, aby przejść do ekranu z ustawieniami.

3

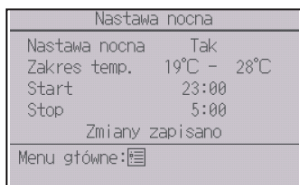

Przesuń kursor na odpowiednią pozycję za pomocą przycisków **[F1]** i **[F2]**, aby wybrać spośród opcji: Nastawa nocna Nie (wyłączona)/Tak (włączona), Zakres temp., Start oraz Stop.

Zmień ustawienie za pomocą przycisków **[F3]** i **[F4]**.

- Zakres temp.: Możliwe jest ustawienie dolnej temperatury granicznej (dla grzania) oraz górnej temperatury granicznej (dla chłodzenia). Różnica między dolną i górną temperaturą graniczną powinna wynosić 4°C (8°F) lub więcej. Dostępny zakres temperatury zależy od przyłączonej jednostki wewnętrznej.
* Odstępy co 1°C
- Start/Stop: ustawiany w krokach co 5 minut
- * Naciśnij i przytrzymaj, aby przyspieszyć wyświetlanie liczb.

Naciśnij przycisk **[WYBIERZ]**, aby zachować ustawienia.

Pojawi się ekran z potwierdzeniem.

Poruszanie się po ekranach

- Powrót do menu głównego przycisk **[MENU]**
- Powrót do poprzedniego ekranu przycisk **[POWRÓT]**

Ustawienia funkcji



Jeżeli funkcja nastawy nocnej jest włączona, na ekranie statusu i ekranie głównym w trybie pełnym pojawi się .

Jeśli programator zostanie wyłączony przez centralny system sterowania, pojawi się .

Nastawa nocna nie działa w następujących przypadkach:

gdy urządzenie jest włączone, gdy nastawa nocna jest wyłączona, podczas wystąpienia błędu, podczas kontroli (w menu czynności obsługowych), podczas uruchomienia testowego, podczas zdalnej diagnostyki sterownika, jeżeli zegar nie jest ustawiony, podczas ustawiania funkcji, jeżeli system jest centralnie sterowany (kiedy ustawianie temperatury i obsługa funkcji Wł/Wył lub programator przy użyciu lokalnego sterownika są zabronione).

Ustawienie ograniczenia zakresu temperatury

Obsługa za pomocą przycisków

1



Wybierz „Oszczędzanie energii” z menu głównego (patrz strona 24) i naciśnij przycisk **WYBIERZ**.

2

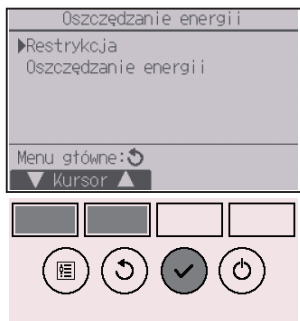

Przesuń kursor na pozycję „Restrykcja” za pomocą przycisków **F1** lub **F2** i naciśnij przycisk **WYBIERZ**.

Ustawienia funkcji

3



Zostaną wyświetlone bieżące ustawienia.

Przesuń kursor na pozycję „Zakres temp.” za pomocą przycisków **[F1]** i **[F2]** i naciśnij przycisk **[WYBIERZ]**.

4



Pojawi się ekran, na którym można zmienić zakres temperatury.

Przesuń kursor na odpowiednią pozycję za pomocą przycisku **[F1]**, aby wybrać spośród „Zakres temp.”, „Chł•Susz”, „Grzanie” lub „Auto”.

5

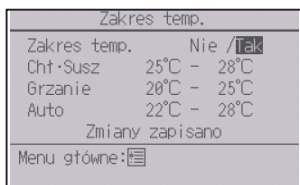
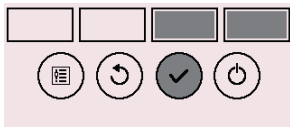
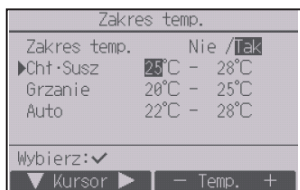

Zmień ustawienie za pomocą przycisków [F3] i [F4].

- Zakres temp.: Nie (bez ograniczeń) lub Tak (ograniczony)
- Chł+Susz: Górna i dolna temperatura graniczna (odstęp co 1°C)
- Grzanie: Górna i dolna temperatura graniczna (odstęp co 1°C)
- Auto: Górna i dolna temperatura graniczna (odstęp co 1°C)

Zakresy ustawień temperatury

Tryb		Dolny limit	Górny limit
Chł+Susz	*1	19 ~ 30°C	30 ~ 19°C
	*3	(67 ~ 87°F)	(87 ~ 67°F)
Grzanie	*2	17 ~ 28°C	28 ~ 17°C
	*3	(63 ~ 83°F)	(83 ~ 63°F)
Auto	*4	19 ~ 28°C	28 ~ 19°C
		(67 ~ 83°F)	(83 ~ 67°F)

* Dostępny zakres zależy od przyłączonej jednostki.

*1 Można ustawić zakresy temperatury dla trybów Chłodzenie, Suszenie i Auto (podwójna wartość zadana).

*2 Można ustawić zakresy temperatur dla trybów Grzanie i Auto (podwójna wartość zadana).

*3 Zakresy temperatur dla trybów Grzanie, Chłodzenie oraz Suszenie muszą spełniać poniższe warunki:

- Górna granica temperatury chłodzenia - górna granica temperatury grzania \geq minimalna różnica temperatur (różni się w zależności od modelu jednostki wewnętrznej)
- Dolna granica temperatury chłodzenia - dolna granica temperatury grzania \geq minimalna różnica temperatur (różni się w zależności od modelu jednostki wewnętrznej)

*4 Można ustawić zakres temperatur dla trybu Auto (pojedyncza wartość zadana).

Naciśnij przycisk [WYBIERZ], aby zachować ustawienia.

Pojawi się ekran z potwierdzeniem.

Poruszanie się po ekranach

- Powrót do menu głównego przycisk [MENU]
- Powrót do poprzedniego ekranu przycisk [POWRÓT]



Jeżeli zakres temperatury jest ograniczony, na ekranie statusu i ekranie głównym w trybie pełnym pojawi się  .

Ustawienia funkcji

Restrykcja



Funkcja blokady działania

Obsługa za pomocą przycisków

Aby włączyć funkcję blokady działania, należy ustawić opcję „Czynność zabł.” w pozycji „Tak”.

1



Przejdź do ekranu z ustawieniami Restrykcja. (Patrz strona 43).

Przesuń kursor na pozycję „Czynność zabł.” i naciśnij przycisk **WYBIERZ**.

2

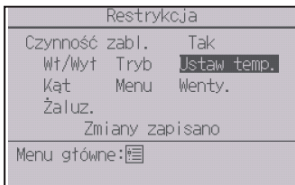

Pojawi się ekran, na którym można dokonać zmian funkcji blokady działania.

Przesuń kursor na odpowiednią pozycję za pomocą przycisków [F1] i [F2], aby wybrać spośród: „Czynność zabł.”, „Lokalizacja”, „Wł/Wył”, „Tryb”, „Ustaw temp.”, „Menu”, „Wenty.”, „Żaluz.” lub „Kąt”.

Zmień ustawienie za pomocą przycisków [F3] i [F4].

- Czynność zabł.: Nie (wyłączona) / Tak (włączona)
- Lokalizacja: „Indyw.” lub „Hotel”
- Wł/Wył: Funkcja Włącz/Wyłącz
- Tryb: Ustawienie trybu działania
- Ustaw temp.: Zadana temperatura
- Kąt: Ustawienia kątów łopatek
- Menu: Ustawienia menu
- Wenty.: Prędkość wentylatora
- Żaluz.: Ustawienia żaluzji

„-” / „Zablok”

Jeżeli w ustawieniach „Lokalizacja” wybrano opcję „Hotel”, następujące czynności zostaną automatycznie zablokowane: Tryb, Kąt, Menu i Żaluzje.

Naciśnij przycisk [WYBIERZ], aby zachować ustawienia.

Pojawi się ekran z potwierdzeniem.

Poruszanie się po ekranach

- Powrót do menu głównego przycisk [MENU]
- Powrót do poprzedniego ekranu przycisk [POWRÓT]

Ustawienia funkcji



Jeżeli funkcja blokowania czynności jest włączona, na ekranie statusu i ekranie głównym w trybie pełnym pojawi się  .

Objaśnienia związane z zablokowanymi funkcjami zostaną ukryte.

Aby wyświetlić menu główne podczas blokady ustawień menu, naciśnij i przytrzymaj przycisk **Ustawień** przez co najmniej 10 sekund. Wpisz hasło administratora na ekranie wprowadzania.

Automatyczny powrót do zadanej temperatury

Po włączeniu funkcji Automatyczny powrót, gdy wykonana została zmiana trybu działania lub włączenia/wyłączenia przy użyciu tego zdalnego urządzenia sterującego, ustawiona temperatura automatycznie powraca do temperatury żądanej bez względu na ustawiony czas.

Obsługa za pomocą przycisków

1

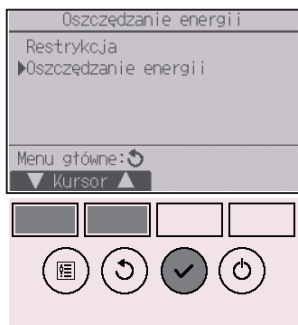

Z menu oszczędzanie energii wybierz „Oszczędzanie energii” i naciśnij przycisk **WYBIERZ**.

2



Zostaną wyświetlone bieżące ustawienia.

Przesuń kursor na pozycję „Auto. powrót” za pomocą przycisków **F1** i **F2** i naciśnij przycisk **WYBIERZ**.

Ustawienia funkcji

3



Pojawi się ekran, na którym można dokonać zmian ustawień funkcji automatycznego powrotu do zadanej temperatury.

Przesuń kursor na odpowiednią pozycję za pomocą przycisków [F1] i [F2], aby wybrać spośród: „Auto. powrót”, „Chłodzenie” lub „Grzanie”.

4



Zmień ustawienie za pomocą przycisków [F3] i [F4].

- Auto. powrót: Nie (wyłączona) / Tak (włączona)
- Chłodzenie: Zakres programatora wynosi od 30 do 120 minut w odstępach co 10 minut. Zakres temperatury wynosi od 19 do 30°C (67 do 87°F) (odstęp co 1°C).
- Grzanie: Zakres programatora wynosi od 30 do 120 minut w odstępach co 10 minut. Zakres temperatury wynosi od 17 do 28°C (63 do 83°F) (odstęp co 1°C).

Naciśnij przycisk [WYBIERZ], aby zachować ustawienia. „Chłódz.” obejmuje tryby: „Susz.” i „Auto Chłódz.”, „Grzanie” obejmuje tryb „Auto Grzanie”. Pojawi się ekran, na którym można zmienić wybraną pozycję.



Poruszanie się po ekranach

- Powrót do menu głównego przycisk [MENU]
- Powrót do poprzedniego ekranu przycisk [POWRÓT]

Ustawienia temperatur lub funkcji programatora są nieaktywne, jeżeli występuje ograniczenie zakresu temperatury lub gdy system jest centralnie sterowany (gdy ustawianie zakresu temperatury z lokalnego sterownika jest niedozwolone). Gdy system jest sterowany centralnie (gdy niedozwolone jest ustawianie funkcji programatora z lokalnego sterownika), tylko ustawienia funkcji programatora będą nieaktywne.

Ustawienie harmonogramu dla opcji oszczędzania energii

Obsługa za pomocą przycisków

1



Przejdźcie do ekranu „Oszczędzanie energii”. (Patrz strona 49).

Przesuń kursor na pozycję „Programator” i naciśnij przycisk **WYBIERZ**.

2



Pojawi się ekran, na którym będzie wyświetlony harmonogram.

Użyj przycisków **F1** i **F2**, aby wyświetlić ustawienia dla każdego dnia tygodnia.

Naciśnij przycisk **WYBIERZ**, aby przejść do ekranu z ustawieniami.

3

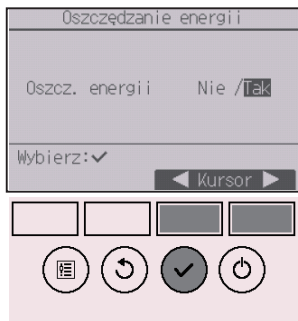

Pojawi się ekran, na którym można włączyć (Tak) lub wyłączyć (Nie) harmonogram opcji oszczędzania energii.

Wybierz „Nie” lub „Tak” za pomocą przycisków **F3** i **F4**.

Naciśnij przycisk **WYBIERZ**, aby przejść do zmiany ustawień/ekranu wyboru dni tygodnia.

Ustawienia funkcji

4



Pojawi się ekran z ustawieniami dla dni tygodnia.

Do każdego dnia można przypisać maksymalnie 4 schematy działania.

Przesuń kursor na odpowiedni dzień tygodnia za pomocą przycisków [F1] i [F2] i naciśnij przycisk [F3], aby dokonać wyboru. (Można zaznaczyć kilka dni). Naciśnij przycisk [WYBIERZ], aby przejść do ekranu z ustawieniami schematu.

5



Zostanie wyświetlony ekran z ustawieniami schematu.

Przesuń kursor za pomocą przycisku [F1] na odpowiedni numer schematu działania.

Przesuń kursor za pomocą przycisku [F2], aby wybrać spośród opcji: czas start, czas stop, poziom oszczędności energii (w kolejności od lewej).

Zmień ustawienie za pomocą przycisków [F3] i [F4].

- Start/Stop: ustawiany w krokach co 5 minut
- * Naciśnij i przytrzymaj, aby przyspieszyć wyświetlanie liczb.
- Poziom oszczędzania energii: Zakres ustawień to 0% i 50-90% w odstępach co 10%.

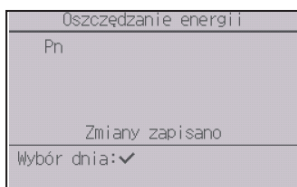

Naciśnij przycisk [WYBIERZ], aby zachować ustawienia.

Pojawi się ekran z potwierdzeniem.

Im niższa wartość, tym większy efekt oszczędności energii.



Kiedy jednostka pracuje w trybie oszczędzania energii, na ekranie statusu i ekranie głównym w trybie pełnym pojawi się  .

Poruszanie się po ekranach

- Powrót do zmiany ustawień/ekranu wyboru dni tygodnia przycisk **[WYBIERZ]**
- Powrót do menu głównego przycisk **[MENU]**
- Powrót do poprzedniego ekranu przycisk **[POWRÓT]**

Ustawienia funkcji

Zegar



Obsługa za pomocą przycisków

1



Wybierz „Ustawienie początkowe” z menu głównego (patrz strona 24) i naciśnij przycisk **WYBIERZ**.

Ustawienie zegara jest wymagane przed dokonaniem zmian poniższych ustawień.

- Programator Włączania/Wyłączania
- Programator tygodniowy
- Tryb cichy jednostki zewnętrznej
- Oszczędzanie energii
- Nastawa nocna

Jeśli dany system nie ma sterowników, godzina na zegarze nie zostanie zaktualizowana automatycznie. W takim przypadku należy okresowo ponownie ustawiać czas na zegarze.

2



Przesuń kursor na pozycję „Podstawowe ustawienia” za pomocą przycisków **F1** i **F2** i naciśnij przycisk **WYBIERZ**.

3



Wybierz opcję „Zegar” za pomocą przycisków **F1** i **F2** i naciśnij przycisk **WYBIERZ**.

4



Przesuń kursor na pozycję „Zegar” za pomocą przycisków [F1] lub [F2] i naciśnij przycisk [WYBIERZ].

5



Przesuń kursor na odpowiednią pozycję za pomocą przycisków [F1] i [F2], aby ustawić rok, miesiąc, datę, godzinę i minuty.

Zwiększ lub zmniejsz wybraną wartość za pomocą przycisków [F3] i [F4] i naciśnij przycisk [WYBIERZ]. Pojawi się ekran z potwierdzeniem.

Poruszanie się po ekranach

- Powrót do menu głównego przycisk [MENU]
- Powrót do poprzedniego ekranu przycisk [POWRÓT]

Ustawienia funkcji

Czas letni



Opis funkcji

Można ustawić godzinę oznaczającą początek/koniec czasu letniego. Funkcja czasu letniego zostanie aktywowana na podstawie zawartości ustawień.

- Jeśli w danym systemie znajduje się sterownik systemowy, to ustawienie należy wyłączyć, aby godzina była zawsze prawidłowa.
- Na początku i na końcu czasu letniego regulator czasowy może zadziałać dwukrotnie lub wcale.
- Ta funkcja nie zadziała, jeśli nie ustawiono zegara.

Obsługa za pomocą przycisków

1



Wybierz „Zegar” z menu ustawień podstawowych i naciśnij przycisk **WYBIERZ**.

2



Przesuń kursor na pozycję „Czas letni” za pomocą przycisków **F1** i **F2** i naciśnij przycisk **WYBIERZ**.

3

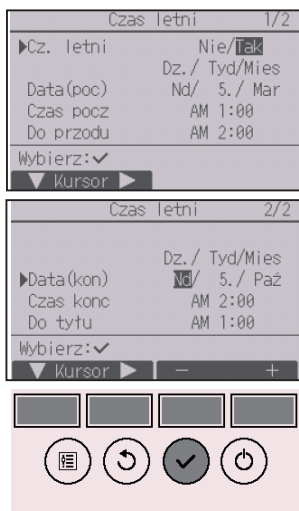

Aby wprowadzić ustawienia, przesunąć kursor na następujące pozycje, używając przycisku [F1].

- Cz. letni
Przyciskiem [F2] „Nie” (wył.) lub „Tak” (wł.). Ustawienie domyślne to „Nie”.

- Data(poc)*1
Służy do ustawiania dnia tygodnia, numeru tygodnia i miesiąca przyciskami [F3] i [F4]. Ustawienie domyślne to „Nd/5./Mar”.

- Czas pocz
Służy do ustawiania czasu pocz. dla czasu letniego przyciskami [F3] i [F4].

- Do przodu
Służy do ustawiania czasu w przypadku potrzeby przesunięcia godziny do przodu w czasie pocz. przyciskami [F3] i [F4].

- Data(kon)*1 (strona 2)
Służy do ustawiania dnia tygodnia, numeru tygodnia i miesiąca przyciskami [F3] i [F4]. Ustawienie domyślne to „Nd/5./Paź”.

- Czas konc (strona 2)
Służy do ustawiania czasu konc. dla czasu letniego przyciskami [F3] i [F4].

- Do tyłu (strona 2)
Służy do ustawiania czasu w przypadku potrzeby przesunięcia godziny do tyłu w czasie konc. przyciskami [F3] i [F4].

*1 Jeśli jako numer tygodnia wybrano opcję „5.”, a 5. tygodnia nie ma w wybranym miesiącu roku, zostanie przyjęty tydzień „4.”.

Naciśnij przycisk [WYBIERZ], aby zachować ustawienia. Pojawi się ekran z potwierdzeniem.

Poruszanie się po ekranach

- Powrót do menu głównego przycisk [MENU]
- Powrót do poprzedniego ekranu przycisk [POWRÓT]

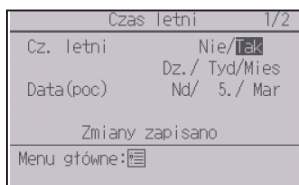

Ustawienia funkcji

Ekran główny



Obsługa za pomocą przycisków

1



Wybierz „Ustawienia wyświetlacza” z menu ustawień początkowych i naciśnij przycisk **WYBIERZ**.

2



Przesuń kursor na pozycję „Ekran główny” za pomocą przycisków **F1** i **F2** i naciśnij przycisk **WYBIERZ**.

3



Za pomocą przycisków **F3** i **F4** wybierz „Pełne” lub „Podst.” (patrz strona 10) i naciśnij przycisk **WYBIERZ**.

Pojawi się ekran z potwierdzeniem.

Poruszanie się po ekranach

- Powrót do menu głównego przycisk **MENU**
- Powrót do poprzedniego ekranu przycisk **POWRÓT**

Obsługa za pomocą przycisków

1



Wybierz „Ustawienia wyświetlacza” z menu ustawień początkowych i naciśnij przycisk **WYBIERZ**.

2

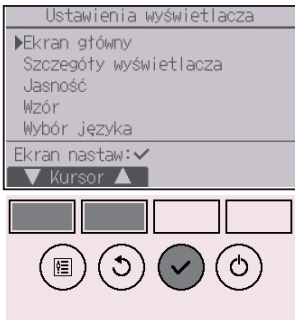

Przesuń kursor na pozycję „Ekran główny” za pomocą przycisków **F1** i **F2** i naciśnij przycisk **WYBIERZ**.

3



Za pomocą przycisków **F1** i **F2** wybierz „Objaśn. ikon”. Za pomocą przycisków **F3** i **F4** wybierz „Tak” lub „Nie” i naciśnij przycisk **WYBIERZ**, aby zatwierdzić.

Ustawienie domyślne to „Tak”.

Poruszanie się po ekranach

- Powrót do menu głównego przycisk **MENU**
- Powrót do poprzedniego ekranu przycisk **POWRÓT**

Ustawienia funkcji

4

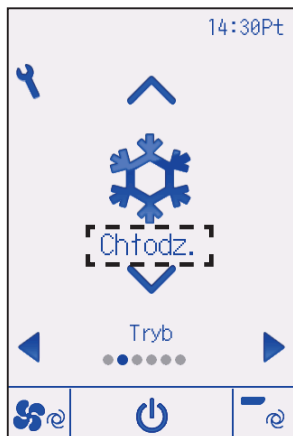

Jeżeli wybrana opcja to „Tak”, wyjaśnienie ikony elementów ustawień będzie widoczne, tak jak pokazano po lewej stronie.

Obsługa za pomocą przycisków

1



Wybierz „Ustawienia wyświetlacza” z menu ustawień początkowych i naciśnij przycisk **[WYBIERZ]**.

2



Przesuń kursor na pozycję „Jasność” za pomocą przycisków **[F1]** lub **[F2]** i naciśnij przycisk **[WYBIERZ]**.

3



Dopasuj jasność za pomocą przycisków **[F1]** i **[F2]**. Za pomocą przycisku **[F4]** można wybrać „Wł.” lub „Wył.” dla ustawienia „Oświetlony”.

Jeśli wybrane zostanie ustawienie „Wł.”, podświetlenie pozostanie włączone nawet po upływie czasu podświetlenia, niemniej będzie przyciemnione.

Poruszanie się po ekranach

- Powrót do menu głównego przycisk **[MENU]**
- Powrót do poprzedniego ekranu przycisk **[POWRÓT]**

Ustawienia funkcji

Wybór języka



Opis funkcji

Opcja wyboru języka. Dostępne języki to: angielski, francuski, niemiecki, hiszpański, włoski, portugalski, szwedzki, rosyjski, grecki, turecki, holenderski, czeski, węgierski i polski.

Obsługa za pomocą przycisków

1



Wybierz „Ustawienia wyświetlacza” z menu ustawień początkowych i naciśnij przycisk **WYBIERZ**.

2



Przesuń kursor na pozycję „Wybór języka” za pomocą przycisków **F1** i **F2** i naciśnij przycisk **WYBIERZ**.

3



Przesuń kursor na żądany język za pomocą przycisków od [F1] do [F4] i naciśnij przycisk **[WYBIERZ]**, aby zapisać ustawienie.

Po pierwszym włączeniu zasilania zostanie wyświetlony ekran Wybór języka. Wybierz odpowiedni język. System nie uruchomi się bez wybrania języka.



Pojawi się ekran informujący o zapisaniu ustawień.

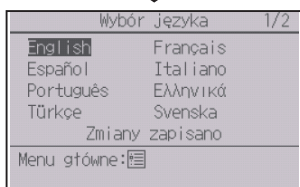

Poruszanie się po ekranach

- Powrót do menu głównego przycisk **[MENU]**
- Powrót do poprzedniego ekranu przycisk **[POWRÓT]**

Ustawienia funkcji

Wzór



Obsługa za pomocą przycisków

1



Wybierz „Ustawienia wyświetlacza” z menu ustawień początkowych i naciśnij przycisk **[WYBIERZ]**.

2



Przesuń kursor na pozycję „Wzór” za pomocą przycisków **[F1]** lub **[F2]** i naciśnij przycisk **[WYBIERZ]**.

3



Wybierz „Kolor” za pomocą przycisku **[F4]**.

- Kolor: Kolor wyświetlacza można zmienić. (Patrz następna strona)
- Biały: Wyświetlacz monochromatyczny (białe tło)
- Czarny: Wyświetlacz monochromatyczny (czarne tło)

Po wybraniu opcji „Biały” lub „Czarny” naciśnij przycisk **[WYBIERZ]**. Po wybraniu opcji „Kolor” wybierz odpowiedni kolor zgodnie z informacjami zawartymi na następnej stronie.

4



Za pomocą przycisku **F1** lub **F2** ustaw żądane kolory, w jakich wyświetlane będą poszczególne elementy.

- Odcień koloru: Za pomocą przycisku **F3** lub **F4** ustaw odcień koloru. (Dopuszczalny zakres ustawień wynosi od -90 do 89).
- Wzorzysty: Ustaw kolor za pomocą przycisku **F4**.
- Kolor ust. na: Za pomocą przycisku **F4** wybierz opcję „Znak” lub „Tło”, do której zastosowany zostanie kolor.

Kolor próbny pod przyciskami funkcyjnymi będzie zmieniał się zgodnie z wybranym ustawieniem.

Wybierz żądany kolor i naciśnij przycisk **WYBIERZ**.

Poruszanie się po ekranach

- Powrót do menu głównego przycisk **MENU**
- Powrót do poprzedniego ekranu przycisk **POWRÓT**

Ustawienia funkcji

Kalibracja panelu dotykowego



Obsługa za pomocą przycisków

1

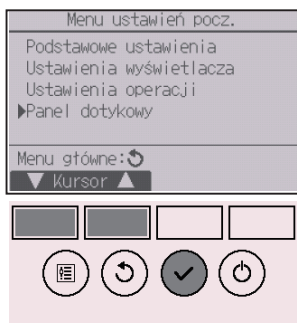

Wybierz „Panel dotykowy” z menu ustawień początkowych i naciśnij przycisk **WYBIERZ**.

2

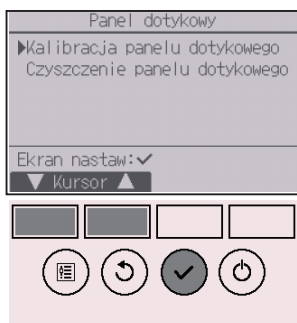

Przesuń kursor na pozycję „Kalibracja panelu dotykowego” za pomocą przycisków **F1** i **F2** i naciśnij przycisk **WYBIERZ**.

3

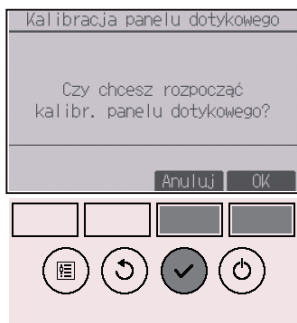

Pojawi się ekran z potwierdzeniem. Wybierz opcję „Anuluj” lub „OK” za pomocą przycisków **F3** i **F4** i naciśnij przycisk **WYBIERZ**.

4

Dotknij czarne kropki w kolejności ich pojawiania się na ekranie. Będzie ich w sumie dziewięć.

Dotknij czarne kropki długopisem dotykowym w ciągu minuty, rozpoczynając od górnego lewego rogu.

Dotknij dziewięciu czarnych kropek w kolejności pojawiania się na ekranie.

Po dotknięciu wszystkich kropek kalibracja zostanie ukończona, a na wyświetlaczu pokaże się menu panelu dotykowego.

- Jeżeli panel nie zostanie dotknięty przez minutę, kalibracja zostanie przerwana i wyświetli się poprzedni ekran.
- Aby prawidłowo skalibrować panel dotykowy, do dotykania kropek użyj cienko zakończzonego, ale nie ostrego przedmiotu.
 - * Ostro przedmiot może uszkodzić lub porysować panel dotykowy.

Ustawienia funkcji

Czyszczenie panelu dotykowego



Obsługa za pomocą przycisków

1

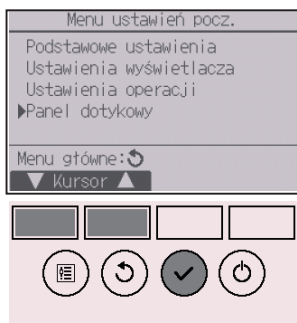

Wybierz „Panel dotykowy” z menu ustawień początkowych i naciśnij przycisk **WYBIERZ**.

2

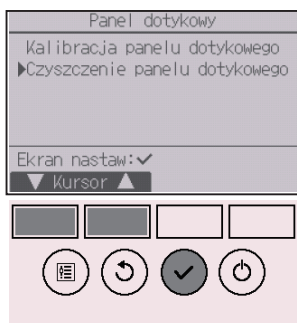

Przesuń kursor na pozycję „Czyszczenie panelu dotykowego” za pomocą przycisków **F1** i **F2** i naciśnij przycisk **WYBIERZ**.

3

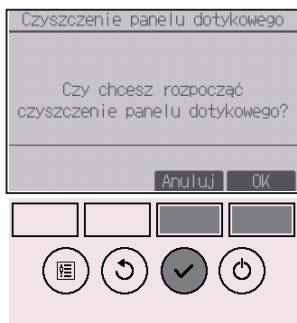

Pojawi się ekran z potwierdzeniem. Wybierz opcję „Anuluj” lub „OK” za pomocą przycisków **F3** i **F4** i naciśnij przycisk **WYBIERZ**.

4

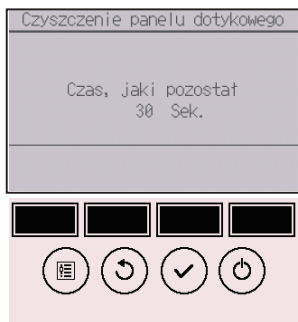

Ekran pozwala użytkownikowi na przecieranie panelu dotykowego przez 30 sekund bez przypadkowej zmiany ustawień.

Po upływie 30 sekund wyświetli się menu panelu dotykowego.

- Ekran należy przetrzeć miękką ściereczką zwilżoną łagodnym detergentem lub etanolem. Do czyszczenia nie należy używać roztworów kwasów/zasad.

Ustawienia funkcji

Uruchamianie pilota



Opis funkcji

Sterownik może zostać uruchomiony w stanie fabrycznym. Następujące dane zostaną uruchomione. Sterownik zostanie automatycznie włączony po zakończeniu uruchamiania.

Ustawienia timera, ustawienia programatora tygodniowego, ustawienia trybu cichego jednostki zewnętrznej, ustawienia oszczędzania energii, ustawienia opcji oszczędzania energii, ustawienia zegara, ustawienia czasu letniego, ustawienia ekranu głównego, ustawienia jasności, ustawienia szczegółów wyświetlacza, ustawienia wzoru, ustawienia trybu Auto, ustawienia nazwy modelu, ustawienia numeru seryjnego, ustawienia informacji o dostawcy, informacje o błędzie, hasło administratora, hasło serwisowe.

Obsługa za pomocą przycisków

1

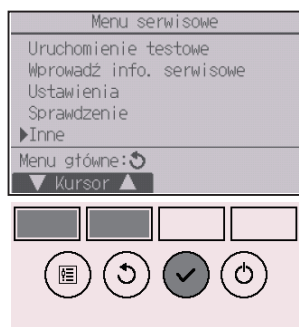

Z menu serwisowego wybierz „Inne” i naciśnij przycisk **WYBIERZ**.

2

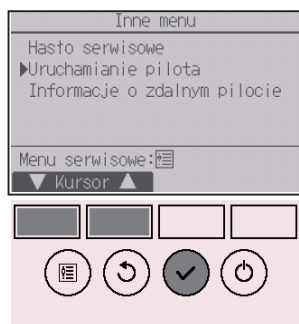

Przesuń kursor na pozycję „Uruchamianie pilota” za pomocą przycisków **F1** i **F2** i naciśnij przycisk **WYBIERZ**.

3

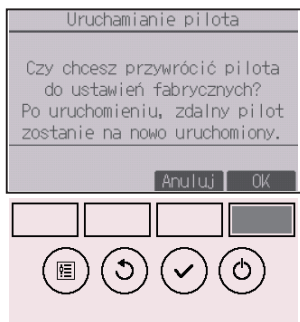

Wybierz „OK” za pomocą przycisku [F4].

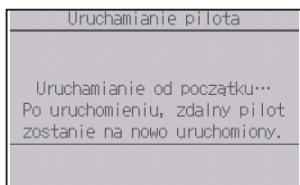

Sterownik zostanie automatycznie włączony po zakończeniu uruchamiania.

Ustawienia funkcji

Informacje o zdalnym pilocie



Opis funkcji

Ekran ten umożliwia sprawdzenie poniższych ustawień sterownika.

Obsługa za pomocą przycisków

1

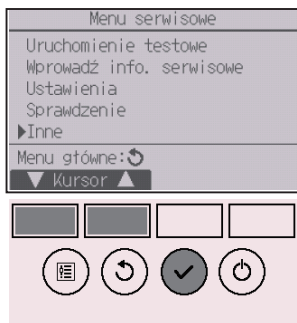

Z menu serwisowego wybierz „Inne” i naciśnij przycisk **WYBIERZ**.

2

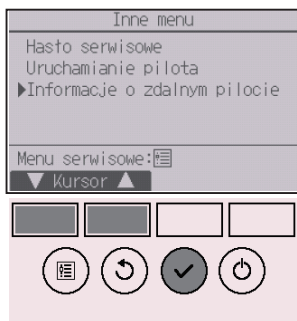

Przesuń kursor na pozycję „Informacje o zdalnym pilocie” za pomocą przycisków **F1** i **F2** i naciśnij przycisk **WYBIERZ**.

3

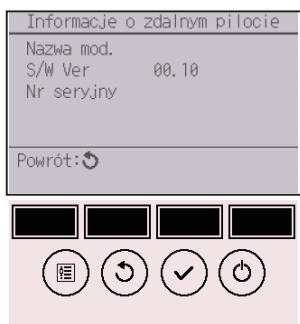

Ekran pozwala na sprawdzenie nazwy modelu, wersji oprogramowania i numeru seryjnego sterownika.

Rozwiązywanie problemów

Informacje o błędzie

Gdy wystąpi błąd, zostanie wyświetlony poniższy ekran, a dioda LED zamiga. Sprawdź stan błędu, zatrzymaj działanie i skonsultuj się z dystrybutorem.

Obsługa za pomocą przycisków

1



Wyświetlone zostaną: kod błędu, błąd urządzenia, adres układu chłodzącego, nazwa modelu, data i czas wystąpienia błędu oraz numer seryjny. Nazwa modelu oraz numer seryjny zostaną wyświetlone, jeżeli wcześniej zostały zapisane.

Naciśnij przycisk **[F1]** lub **[F2]**, aby przejść do następnej strony.

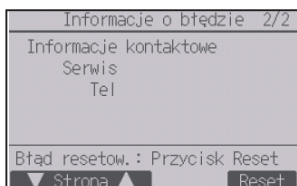

Informacje kontaktowe (numer telefonu dystrybutora) zostaną wyświetlone, jeżeli wcześniej je zapisano.

2



Naciśnij przycisk **[F4]** lub **[WŁ/WYŁ]**, aby wyzerować błąd, który wystąpił.

Błędy nie mogą zostać wyzerowane, jeżeli zabroniona jest operacja Włącz/Wyłącz.



Wybierz „OK” za pomocą przycisku **[F4]**.

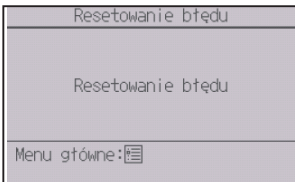

Pojawi się ekran z potwierdzeniem.

Poruszanie się po ekranach

- Powrót do menu głównego przycisk **[MENU]**

Rozwiązywanie problemów

Sprawdzanie informacji o błędach

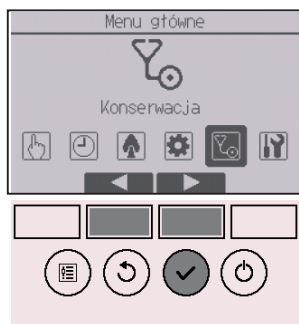

Gdy nie występuje żaden błąd, strona 2/2 informacji o błędzie (patrz strona 74) może zostać wyświetlona z poziomu menu działania.

Z menu głównego wybierz menu „Konservacji” i naciśnij przycisk **WYBIERZ**.

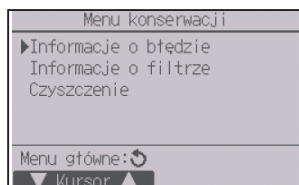

Aby wyświetlić ekran z informacją o błędzie, z menu konserwacji wybierz opcję „Informacje o błędzie”.

Błędy nie mogą zostać wyzerowane.

Nieobecność, automatyczne wyłączenie

Poniższy ekran pojawi się w przypadku modeli panelowych 3D i-See sensor, gdy urządzenie zatrzyma się w wyniku działania funkcji Nieobecność, automatyczne wyłączenie opcji oszczędzania energii.

Ustawienia 3D i-See sensor, patrz instrukcja obsługi jednostki wewnętrznej.

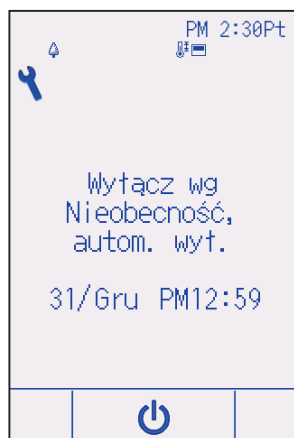

Konserwacja

Informacje o filtrze



Gdy należy wyczyścić filtry, na ekranie statusu i ekranie głównym w trybie pełnym pojawi się .

Gdy pojawi się ten znak, należy umyć, wyczyścić lub wymienić filtry.

Szczegóły znajdują się w instrukcji instalacji jednostki wewnętrznej.

Obsługa za pomocą przycisków

1



Z menu konserwacji wybierz „Informacje o filtrze” i naciśnij przycisk **[WYBIERZ]**.

2



Naciśnij przycisk **[F4]**, aby skasować znak filtra. Informacje dotyczące czyszczenia filtra znajdują się w instrukcji instalacji jednostki wewnętrznej.

3

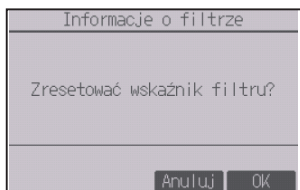

Wybierz „OK” za pomocą przycisku [F4].

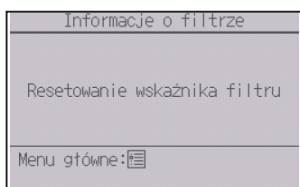
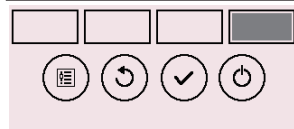

Pojawi się ekran z potwierdzeniem.

Poruszanie się po ekranach

- Powrót do menu głównego przycisk [MENU]
- Powrót do poprzedniego ekranu przycisk [POWRÓT]



Jeżeli na ekranie statusu i ekranie głównym w trybie pełnym wyświetlony jest , oznacza to, że system jest centralnie sterowany i znak filtra nie może być wyzerowany.

Jeżeli przyłączone są co najmniej dwie jednostki wewnętrzne, terminy czyszczenia filtrów mogą się różnić, w zależności od rodzaju filtrów.

Ikona  pojawi się, gdy filtr jednostki głównej wymaga czyszczenia.

Po wyzerowaniu znaku filtra łączny czas pracy wszystkich jednostek zostanie wyzerowany.

Ikona  pojawi się po upływie określonego czasu działania, obliczonego w oparciu o wielkość pomieszczenia, w których jednostki są zainstalowane, oraz standardową czystość powietrza. Jakość powietrza może wpływać na konieczność częstszego czyszczenia filtrów.

Łączny czas pracy, po którym filtr wymaga czyszczenia, zależy od modelu.

Dane techniczne

Dane techniczne sterownika

	Dane techniczne
Wymiary urządzenia	Standard (PAR-CT01MAA(R)-SB/PAR-CT01MAA-S): 65(D) × 120(W) × 14,1(G) mm (2 9/16 × 4 23/32 × 9/16 [in]) (bez części wystających)
	Premium (PAR-CT01MAA(R)-PB): 68(D) × 120(W) × 14,1(G) mm (2 11/16 × 4 23/32 × 9/16 [in]) (bez części wystających)
Ciężar netto	Standard (PAR-CT01MAA(R)-SB/PAR-CT01MAA-S): 0,09 kg (13/64 lbs)
	Premium (PAR-CT01MAA(R)-PB): 0,10 kg (7/32 lbs)
Nominalne napięcie zasilania	12 VDC (dostarczane z jednostek wewnętrznych)
Zużycie energii	0,6 W
Środowisko pracy	Temperatura 0 ~ 40°C (32 ~ 104°F) Wilgotność względna 25 ~ 90% (bez kondensacji)
Materiał	Standard (PAR-CT01MAA(R)-SB/PAR-CT01MAA-S) Korpus: ABS
	Premium (PAR-CT01MAA(R)-PB) Korpus: ABS Płytko boczna: Aluminium

Lista funkcji (wg stanu na 1 października 2017)

○ : Obsługiwane × : Nieobsługiwane

	Funkcja	CITY MULTI	Mr. SLIM	Wymagane hasło
Zasilanie	Włączenie/Wyłączenie zasilania	○	○	-
Ustawienia	Tryb działania	○	○	-
	Tryb Auto (podwójna wartość zadana)	○	○	-
	Zadana temperatura	○	○	-
	Prędkość wentylatora	○	○	-
	Kąt	○	○	-
	Żaluzje	○	○	-
	Wentylacja	○	○	-
Menu Działanie	Duża moc	×	○	-
	Ręczny kąt żaluzji	○	○	-
	3D i-See sensor	○	○	-
Menu timera	Timer (Programator Włączania/Wyłączania)	○	○	administrator
	Timer (Programator automatycznego wyłączenia)	○	○	administrator
	Programator tygodniowy	○	○	administrator
	Tryb cichy jednostki zewnętrznej	○	○	administrator
	Nastawa nocna	○	○	administrator
Menu oszczędzania energii	Ograniczenia zakresu temperatury	○	○	administrator
	Funkcja blokady działania	○	○	administrator
	Automatyczny powrót	○	○	administrator
	Programator	×	○	administrator
Menu ustawień początkowych	Zegar	○	○	administrator
	Format wyświetlania zegara	○	○	administrator
	Czas letni	○	○	administrator
	Ekran główny	○	○	administrator
	Objaśnienia dotyczące ikon	○	○	administrator
	Jasność	○	○	administrator
	Wybór języka	○	○	administrator
	Wzór	○	○	administrator
	Kalibracja panelu dotykowego	○	○	administrator
	Czyszczenie panelu dotykowego	○	○	administrator
Hasło (Administrator)	○	○	administrator	
Menu serwisowe	Uruchamianie pilota	○	○	konserwacja
	Informacje o zdalnym pilocie	○	○	konserwacja
	Uruchomienie testowe	○	○	konserwacja
	Wprowadzanie informacji o modelu	○	○	konserwacja
	Wprowadzanie informacji o Dostawcy	○	○	konserwacja
	Nastawa funkcji	○	○	konserwacja
	Szybki serwis	×	○	konserwacja
	Hasło (Konserwacja)	○	○	konserwacja
Menu konserwacji	Automatycznie opuszczany panel	○	○	-
	Informacje o błędzie	○	○	-
	Informacje o filtrze	○	○	-

* Dostępne funkcje zależą od modelu urządzenia.

Dane techniczne

Lista funkcji, które mogą/nie mogą być używane jednocześnie

	Duża moc	Programator Włączania/Wyłączania	Programator automatycznego wyłączenia	Programator tygodniowy	Tryb cichy jednostki zewnętrznej	Zakres temperatury	Czynność zablokowana	Automatyczny powrót	Harmonogram oszczędzania energii	Nastawa nocna
Duża moc		○	○	○	△ 1	○	△ 2	○	△ 1	○
Programator Włączania/Wyłączania	○		○	× 1	○	○	○	○	○	△ 3
Programator automatycznego wyłączenia	○	○		○	○	○	○	○	○	△ 4
Programator tygodniowy	○	× 1	○		○	○	○	○	○	△ 5
Tryb cichy jednostki zewnętrznej	△ 1	○	○	○		○	○	○	○	○
Zakres temperatury	○	○	○	○	○		○	× 2	○	△ 6
Czynność zablokowana	△ 2	○	○	○	○	○		○	○	○
Automatyczny powrót	○	○	○	○	○	× 2	○		○	△ 7
Harmonogram oszczędzania energii	△ 1	○	○	○	○	○	○	○		○
Nastawa nocna	○	△ 3	△ 4	△ 5	○	△ 6	○	△ 7	○	

○ : Mogą być używane jednocześnie × : Nie mogą być używane jednocześnie △ : Ograniczenie

△ 1: Funkcja jest uruchamiana po zakończeniu pracy w trybie wysokiej wydajności, ponieważ tryb wysokiej wydajności ma wyższy priorytet.

△ 2: Funkcja nie może być uruchomiona, jeżeli istnieje blokada działania.

△ 3: Funkcja Nastawa nocna nie może być uruchomiona, jeżeli urządzenie pracuje według ustawień Programatora Włączania/Wyłączania.

△ 4: Funkcja Automatyczne wyłączenie nie może być użyta w Nastawie nocnej.

△ 5: Funkcja Nastawa nocna nie może być uruchomiona, jeżeli urządzenie pracuje według ustawień Programatora tygodniowego.

△ 6: Ustawienia zakresu temperatury nie mogą być użyte w Nastawie nocnej.

△ 7: Funkcja Automatyczny powrót nie może być użyta w Nastawie nocnej.

× 1: Programator tygodniowy nie jest używany, ponieważ Programator Włączania/Wyłączania ma wyższy priorytet.

× 2: Funkcja Automatyczny powrót nie może być użyta, ponieważ ustawienie zakresu temperatury ma wyższy priorytet.

CITY MULTI-kontrolsystem
og Mitsubishi Mr. SLIM-aircondition anlæg

MA touch-fjernkontrol

PAR-CT01MAA-PB

PAR-CT01MAA-SB

PAR-CT01MAA-S

PAR-CT01MAR-PB

PAR-CT01MAR-SB

Instruktionsbog



Dansk

Inden brug bedes du gennemlæse instruktionerne i denne vejledning for korrekt brug af produktet.

Opbevares til fremtidig brug.



Sørg for, at denne cd-rom og installationsvejledningen videregives til evt. fremtidige brugere. For at sikre en sikker og korrekt brug af fjernkontrollen skal den installeres af uddannet personale.

Indhold

Sikkerhedsanvisninger	4
Kontrolenhedens komponenter	6
Kontrolenhedens grænseflade - Statusdisplay/hoveddisplay	6
Kontrolenhedens grænseflade - Menuskærm	8
Display - Statusdisplay/hoveddisplay	10
Menustruktur og ikoner.....	12
Menustruktur.....	12
Ikonforklaringer	15
Grundfunktioner.....	16
Effekt TÆND/SLUK	16
Indstillinger for funktionstilstand, temperatur, ventilatorhastighed, lamel, spjæld og ventilation (Lossnay).....	17
Sådan navigerer du i menuen	22
Hovedmenuliste	22
Sådan navigerer du i menuen.....	24
Indstilling af funktioner.....	25
High power (Høj effekt).....	25
Manual vane angle (Manuel lamelvinkel)	26
Timer (On/Off timer (Tænd-/sluk-timer))	29
Timer (Auto-Off timer (Autosluk-timer)).....	32
Weekly timer (Ugetimer)	34
OU silent mode (Driftsenhed lydløs funktion)	37
Night setback (Natsænkning)	40
Restriction (Begrænsning)	43
Energy saving (Energibesparende)	49
Clock (Ur).....	54
Daylight saving time (Sommertid).....	56
Main display (Hoveddisplay).....	58
Icon explanation (Ikonforklaring).....	59
Brightness (Lysstyrke)	61
Language selection (Valg af sprog)	62
Design.....	64
Touch panel calibration (Kalibrering af touch-panel).....	66
Touch panel cleaning (Rengøring af touch-panel)	68
Initialize remote controller (Initialisering af fjernkontrol).....	70
Remote controller information (Oplysninger om fjernkontrolenheden)	72
Fejlfinding	74
Error information (Fejlinformation)	74
No occupancy Auto-OFF (Automatisk slukning ved mangel på aktivitet)	77
Vedligeholdelse	78
Filter information (Filterinformation).....	78
Specifikationer	80
Specifikationer for kontrolenhed	80
Funktionsliste (fra 1. oktober 2017)	81
Liste over funktioner, der kan/ikke kan benyttes sammen ...	82

Sikkerhedsanvisninger

- Læs følgende sikkerhedsanvisninger grundigt, før enheden tages i brug.
- Overhold anvisningerne nøje for at garantere sikkerheden.

 ADVARSEL	Angiver livsfare eller fare for alvorlige kvæstelser.
 FORSIGTIG	Angiver fare for alvorlige kvæstelser eller strukturelle skader.

- Når du har læst denne vejledning, skal den videregives til slutbrugeren for opbevaring til fremtidig brug.
- Opbevar denne vejledning til fremtidig brug, og brug den som opslagsværk efter behov. Denne vejledning skal stilles til rådighed for personer, der reparerer eller flytter kontrolenheden. Sørg for, at vejledningen videregives til evt. fremtidige brugere.

Generelle anvisninger

ADVARSEL

Enheden må ikke installeres på et sted, hvor store mængder olie, damp, organiske opløsningsmidler eller korrosive gasser, f.eks. svovlgas, er til stede, eller hvor sure/basiske opløsninger eller spray anvendes regelmæssigt. Disse stoffer kan kompromittere enheden ydeevne eller medføre, at visse af enhedens komponenter korroderer, hvilket kan resultere i elektrisk stød, funktionsfejl, røg eller brand.

For at mindske risikoen for kortslutning, strømlækage, elektrisk stød, funktionsfejl, røg eller brand må kontrolenheden ikke vaskes med vand eller anden væske.

For at mindske risikoen for elektrisk stød, funktionsfejl, røg eller brand må kontakter/knapper ikke betjenes eller andre elektriske dele berøres med våde hænder.

Hvis enheden desinficeres med alkohol, skal der foretages grundig udluftning i rummet. Alkoholampe omkring enheden kan forårsage brand eller eksplosion, når enheden er tændt.

For at mindske risikoen for kvæstelser eller elektrisk stød skal driften stoppes, og kontrolenheden tildækkes, før der sprayes med et kemikalie i nærheden af kontrolenheden.

For at mindske risikoen for kvæstelser eller elektrisk stød skal driften stoppes, og strømforsyningen slukkes, før rengøring, vedligeholdelse eller eftersyn af kontrolenheden.

Hvis du bemærker uregelmæssigheder (f.eks. at der lugter brændt), skal du stoppe anlægget, slukke på afbryderen og henvende dig til din forhandler. Fortsat brug af produktet kan resultere i elektrisk stød, funktionsfejl eller brand.

Montér alle nødvendige paneler korrekt for at holde fugt og støv ude af kontrolenheden. Ophobning af støv og vand kan medføre elektrisk stød, røg eller brand.

FORSIGTIG

For at mindske risikoen for brand eller eksplosion må brændbare materialer ikke placeres, og brændbar spray ikke anvendes, i nærheden af kontrolenheden.

For at mindske risikoen for beskadigelse af kontrolenheden må insektmiddel eller andre brændbare sprays ikke sprøjtes direkte på kontrolenheden.

For at mindske risikoen for miljøforurening skal du rådføre dig med autoriseret instans for korrekt bortskaffelse af fjernkontrollen.

For at mindske risikoen for elektrisk stød eller funktionsfejl må berøringspanel, kontakter eller knapper ikke berøres med en spids eller skarp genstand.

For at mindske risikoen for kvæstelser og elektrisk stød skal kontakt med skarpe kanter på visse dele undgås.

For at undgå risikoen for kvæstelser skal man bære beskyttende udstyr, når man arbejder på kontrolenheden.

For at undgå kvæstelser fra ødelagt glas må glasdelenes ikke udsættes for overdreven kraft.

Anvisninger for flytning eller reparation af kontrolenheden

ADVARSEL

Kontrolenheden må kun repareres eller flyttes af uddannet personale. Kontrolenheden må ikke adskilles eller modificeres. Forkert installation eller reparation kan medføre kvæstelser, elektrisk stød eller brand.

FORSIGTIG

For at mindske risikoen for kortslutning, elektrisk stød, brand eller funktionsfejl må printpladen ikke berøres med værktøj eller med hænderne, og der må ikke ophobes støv på printpladen.

Yderligere anvisninger

For at undgå skader på kontrolenheden skal der bruges korrekt værktøj til installation, eftersyn og reparation af den.

For at undgå misfarvning må kontrolenheden ikke rengøres med benzen, fortynder eller kemiske klude. Kontrolenheden rengøres ved at tørre med en blød klud gennemblødt med vand med et mildt rengøringsmiddel, rengøringsmidlet tørres af med en våd klud, og vandet tørres af med en tør klud.

Denne kontrolenhed er udelukkende designet til brug med bygningsadministrationssystemet fra Mitsubishi Electric. Brug af denne kontrolenhed sammen med andre systemer eller til andre formål kan medføre funktionsfejl.

For at undgå skader på kontrolenheden skal den beskyttes mod statisk elektricitet.

Denne anordning er ikke beregnet til brug af personer (herunder børn) med fysiske, sansemæssige eller mentale handicaps eller manglende erfaring eller viden, medmindre de er under opsyn eller instrueres i brugen af anordningen af en person, som er ansvarlig for deres sikkerhed. Børn skal være under opsyn for at sikre, at de ikke leger med anordningen.

Dette apparat er beregnet til brug af uddannede brugere i butikker, let industri, i landbruget eller anden professionel brug af ikke-uddannede brugere.

Hvis ledningen er beskadiget, skal den udskiftes af producenten, serviceagenten eller lignende kvalificerede personer for at undgå farer.

Kontrolenhedens komponenter

Kontrolenhedens grænseflade - Statusdisplay/hoveddisplay

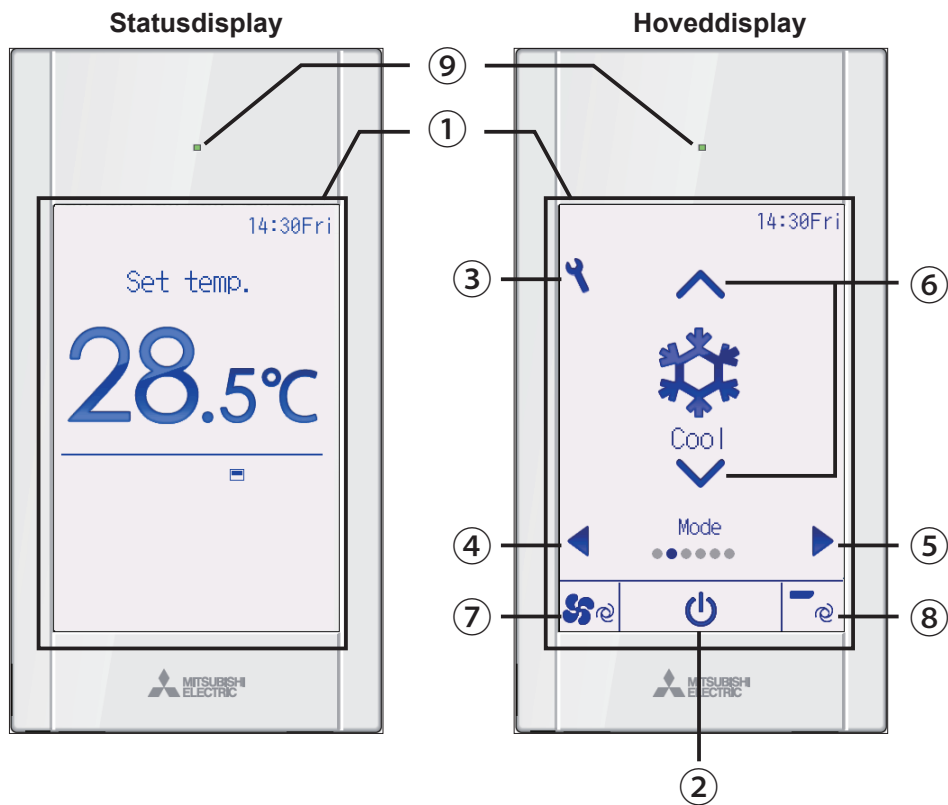

① Touchpanel og bagbelyst farve-LCD

Funktionsindstillingerne vises. Når bagbelysningen er slukket, kan man skifte til statusdisplayet ved at trykke på ethvert område. Når statusdisplayet vises, kan man skifte til hoveddisplayet ved at trykke på ethvert område.

② TÆND/SLUK knap

Tryk for at TÆNDE/SLUKKE for indendørsenheden.

③ Indstilling knap

Tryk for at få vist hovedmenuen. Når menubetjening er låst, er et administratoradgangskode påkrævet.

④ ◀ knap

Bruges til at skifte indstillingselementer i følgende rækkefølge: spjæld, ventilation, lamel, ventilatorhastighed, funktionstilstand og forudindstillet temperatur.

⑤ ▶ knap

Bruges til at skifte indstillingselementer i følgende rækkefølge: forudindstillet temperatur, funktionstilstand, ventilatorhastighed, lamel, ventilation og spjæld.

⑥ ▲ ▼ knap

Bruges til at ændre indholdet i den valgte indstilling i ④ og ⑤ ovenfor.

⑦ Genvejstast til ventilatorhastighed

Bruges til direkte adgang til skærmen til indstilling af ventilatorhastighed.

⑧ Genvejstast til lamel

Bruges til direkte adgang til skærmen til indstilling af lamel.

⑨ TÆND-/SLUK-lampe

Denne lampe lyser grønt, når enheden er i brug, medmindre "LED lighting" (LED-belysning) er sat til "No" (Nej). Den blinker, når fjernkontrollen starter, eller hvis der opstår en fejl.

Når afbryderknappen er låst, vises ② ikke.

Når indstillingselementet ændres med knappen ④ eller ⑤, hvis betjening af det valgte indstillingselement, vises elementet ikke.

Hvis betjening af ventilatorhastigheden eller lamel er låst, vises elementet ⑦ eller ⑧ ikke.

Indstillingsindholdet kan ikke ændres med knappen ⑥, når indstillingselementet styres centralt med systemkontrolenheden.

Kontrolenhedens komponenter

Kontrolenhedens grænseflade - Menuskærm

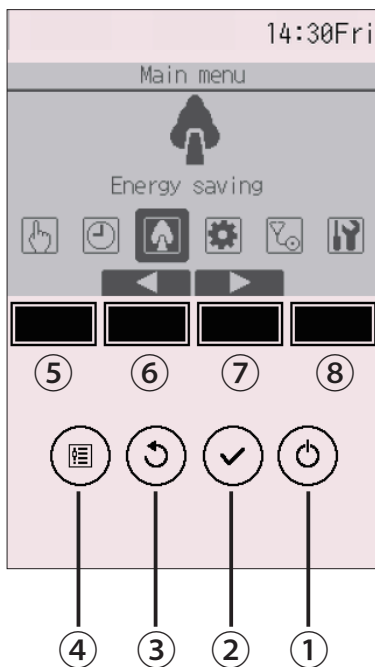

① TÆND/SLUK knap

Tryk for at TÆNDE/SLUKKE for indendørsenheden.

② VÆLG knap

Tryk for at gemme indstillingen.

③ TILBAGE knap

Tryk for at gå tilbage til den foregående skærm.

Når hovedmenuen vises, vises statusdisplayet ved tryk på denne knap.

④ MENU knap

Side 24

Tryk for at få vist hovedmenuen.

⑤ Funktionsknap F1

Menuskærm: Knapfunktionen varierer med skærmen.

⑥ Funktionsknap F2

Hovedmenu: Tryk for at flytte markøren til venstre.

Menuskærm: Knapfunktionen varierer med skærmen.

⑦ Funktionsknap F3

Hovedmenu: Tryk for at flytte markøren til højre.

Menuskærm: Knapfunktionen varierer med skærmen.

⑧ Funktionsknap F4

Menuskærm: Knapfunktionen varierer med skærmen.

Funktionsknappernes funktioner skifter afhængig af skærmen. I vejledning til knapfunktioner, der vises i bunden af LCD'et, kan du se de funktioner, de har på en given skærm.

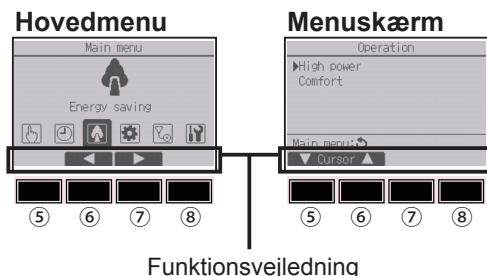

Kontrolenhedens komponenter

Display - Statusdisplay/hoveddisplay

Statusdisplayet og hoveddisplayet kan vises i to forskellige tilstande: "Full" (Komplet) og "Basic" (Enkelt).
Fabriksindstillingen er "Full" (Komplet). Der henvises til side 58 for at se, hvordan tilstanden skiftes.

Komplet funktion

* Alle ikoner vises med forklaring.

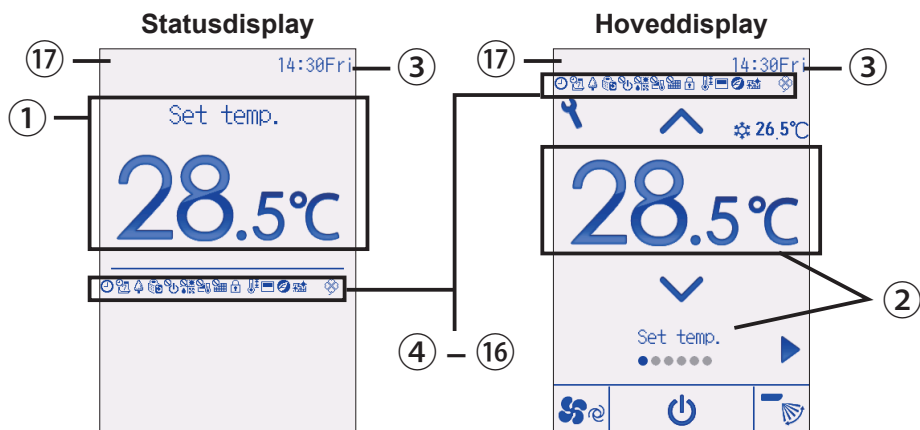

Enkel funktion

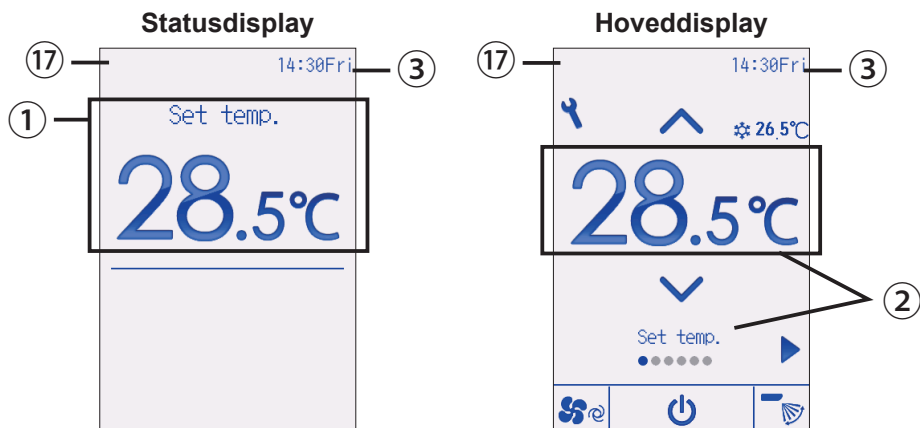

① Forudindstillet temperatur eller rumtemperatur

Forudindstillet temperatur eller rumtemperatur vises her. (Se installationsvejledningen).

② Indstillingselement og indstillingsindhold Side 17

Indstillingselementerne "Forudindstillet temperatur" ↔ "Funktionstilstand" ↔ "Ventilatorhastighed" ↔ "Lamel" ↔ "Ventilation" ↔ "Spjæld" og deres indstillingsindhold vises her. "Centrally controlled" vises i en bestemt tidsperiode, når et centralt styret element bliver betjent.

③ Ur

Her vises den aktuelle tid. (Se installationsvejledningen).

④ Side 29, 32, 40

Vises, når tænd-/sluk-timer (Side 29), natsænkning (Side 40) eller auto-off-timer (Side 32) er aktiveret.

 vises, når timeren deaktiveres af det centraliserede kontrolsystem.

⑤ Side 34

Vises, når ugetimer er aktiveret.

⑥ Side 51

Vises, når enhederne kører i energibesparende funktion. (Vises ikke på visse modeller af indendørsenheder)

⑦ Side 37

Vises, når udendørsenhederne kører i lydløs funktion.

⑧

Vises, når TÆND-/SLUK-funktionen er centralt styret.

⑨

Vises, når funktionstilstanden er centralt styret.

⑩

Vises, når den forudindstillede temperatur er centralt styret.

⑪

Vises, når funktion til nulstilling af filter er centralt styret.

⑫ Side 46

Vises, når knapperne er låst.

⑬ Side 43

Vises, når det forudindstillede temperaturområde er begrænset.

⑭

Vises, når den integrerede termistor på fjernkontrollen er aktiveret til at overvåge rumtemperaturen.

 vises, når termistoren på indendørsenheden er sat til at overvåge rumtemperaturen.

⑮

Vises, når en energibesparende handling udføres ved hjælp af funktionen "3D i-See sensor".

⑯ Side 78

Viser, når filteret skal vedligeholdes.

⑰ Foreløbig fejlvisning

En fejlkode vises under den foreløbige fejl.

Menustruktur og ikoner

Menustruktur

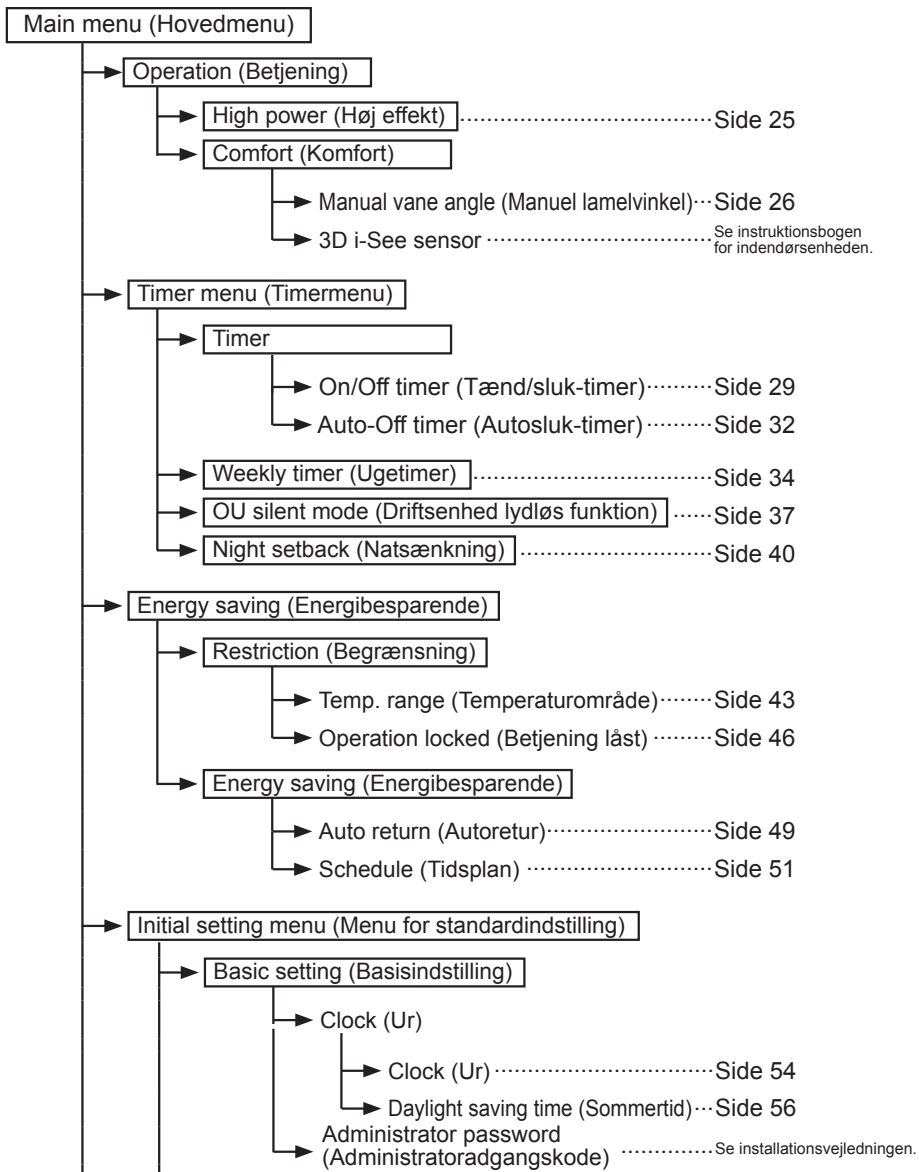

→	Display setting (Displayindstilling)	
	→ Main display (Hoveddisplay)	Side 58
	→ Display details (Displaydetaljer) (Ikonforklaring osv.)	Se installationsvejledningen.
	→ Brightness (Lysstyrke)	Side 61
	→ Language selection (Valg af sprog)	Side 62
	→ Design	Side 64
→	Operation setting (Funktionsindstilling)	
	→ Auto mode (Autofunktion)	Se installationsvejledningen.
→	Touch panel (Touch-panel)	Side 66
→	Maintenance menu (Vedligeholdelsesmenu)	
	→ Error information (Fejlinformation)	Side 74
	→ Filter information (Filterinformation)	Side 78
	→ Cleaning (Rengøring)	
	→ Auto descending panel (Automatisk faldende panel)	Se den instruktionsvejledning, der fulgte med det automatiske løftepanel.
	→ Descending operation (Faldende betjening)	Se den instruktionsvejledning, der fulgte med det automatiske løftepanel.
	→ Descending adjustment (Faldende justering)	Se den instruktionsvejledning, der fulgte med det automatiske løftepanel.
→	Service menu (Servicemenu)	
	→ Test run menu (Testkørselsmenu)	
	→ Test run (Testkørsel)	Se installationsvejledningen for indendørsenheden.
	→ Drain pump test run (Testkørsel af drænpumpe)	Se installationsvejledningen for indendørsenheden.
	→ Maintenance information (Vedligeholdelsesinformation)	Se installationsvejledningen for indendørsenheden.
	→ Model name input (Indtast modelnavn)	Se installationsvejledningen for indendørsenheden.
	→ Serial No. input (Indtast serienummer)	Se installationsvejledningen for indendørsenheden.
	→ Dealer information input (Indtast forhandlerinformation)	Se installationsvejledningen for indendørsenheden.
	→ Initialize maintenance info. (Information om initialisering af vedligeholdelse)	Se installationsvejledningen for indendørsenheden.

Menustruktur og ikoner

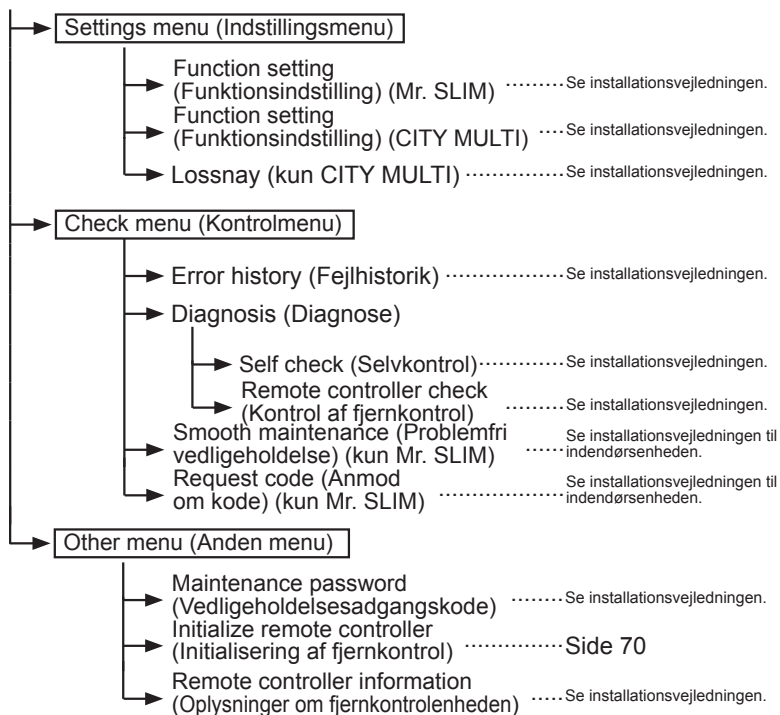

Ikke alle funktioner findes på alle indendørsenhedsmodeller.

Betjening af kontrolenhed

Timer



Tabellen herunder viser de firkantede ikoner, der benyttes i denne vejledning.



Administratoradgangskode eller adgangskode for vedligeholdelsesbrugeren skal indtastes på skærmen til indtastning af adgangskode for at ændre indstillingerne. Ingen af indstillingerne kan springes over i denne procedure.

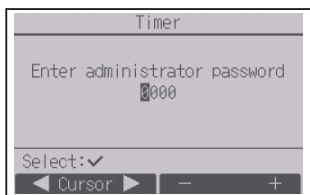

F1 F2 F3 F4

- F1** : Tryk for at flytte markøren til venstre.
- F2** : Tryk for at flytte markøren til højre.
- F3** : Tryk for at reducere værdien med 1.
- F4** : Tryk for at øge værdien med 1.

* Der kan ikke foretages ændringer, med mindre der indtastes korrekt adgangskode.



Viser indstillinger, der kun kan ændres, når enhederne er i brug.



Viser indstillinger, der kun kan ændres, når enhederne ikke er i brug.



Viser indstillinger, der kun kan ændres, når enhederne kører i funktionstilstanden kulde, varme eller auto.



Viser funktioner, der ikke er tilgængelige, når knapperne er låst, eller systemet er centralt styret.

Grundfunktioner

Effekt TÆND/SLUK



Knappbetjening

TÆND

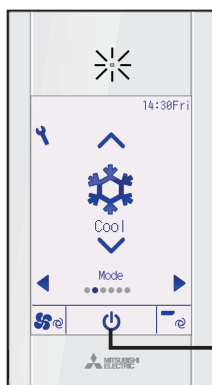

Tryk på **TÆND/SLUK**-knappen.
TÆND-/SLUK-lampen lyser grønt, og anlægget starter.
Når "LED lighting" (LED-belysning) er indstillet til "No" (Nej), lyser TÆND/SLUK-lampen ikke.

SLUK



Tryk på **TÆND/SLUK**-knappen igen.
TÆND-/SLUK-lampen slukkes, og anlægget stopper.



Knapbetjening

Funktionstilstand

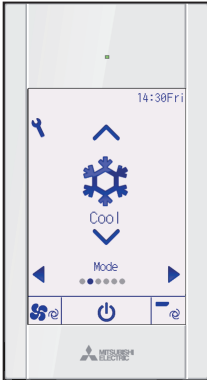

Hvert tryk med ▼- eller ▲-knappen bladrer gennem følgende funktionstilstand.

Vælg den ønskede funktionstilstand.



Kulde



Tør



Ventilator



Auto



Varme

- De funktionstilstande, der ikke er tilgængelige for de tilsluttede indendørsenhedsmodeller, vises ikke på displayet.

Hvad det blinkende funktionsikon betyder

Funktionsikonet blinker, når andre indendørsenheder i samme køleanlæg (tilsluttet til samme udendørsenhed) allerede er brugt i en anden funktionstilstand. I det tilfælde kan resten af enheden i den samme gruppe kun køre i samme funktionstilstand.

<Indstillingen "Auto" (to indstillingspunkter)>

Når funktionstilstanden indstilles til indstillingen "Auto" (to indstillingspunkter), kan der indstilles to forudindstillede temperaturer (én for kulde og én for varme). Alt efter stuetemperaturen kører indendørsenheden automatisk enten indstillingen "Kulde" eller "Varme" og holder stuetemperaturen inden for det forudindstillede område.

Nedenstående graf viser driftsmønstret for en indendørsenhed i indstillingen Auto (to indstillingspunkter).

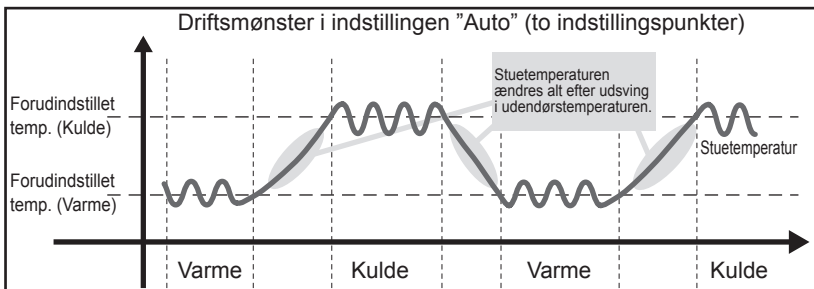

Grundfunktioner

Forudindstillet temperatur

<"Kulde", "Tør", "Varme" og "Auto" (enkelt indstillingspunkt)>

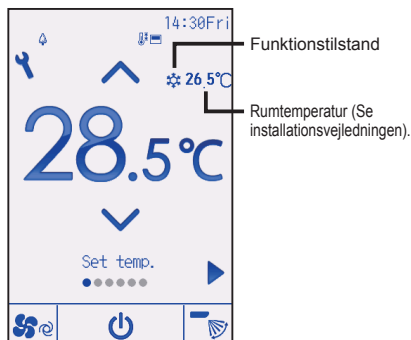

Tryk på -knappen for at reducere den forudindstillede temperatur, og tryk på -knappen for at øge den.

- I tabellen på side 19 kan du se det temperaturområde, der kan indstilles, for de forskellige funktionstilstande.
- Der kan ikke indstilles forudindstillet temperaturområde for ventilator/ventilation.
- Den forudindstillede temperatur vises enten i celsius i trin på 0,5 eller 1 grader eller i fahrenheit, alt efter modellen af indendørsenheden og indstillingen af visningstilstand på fjernbetjeningen.

<Indstillingen "Auto" (to indstillingspunkter)>

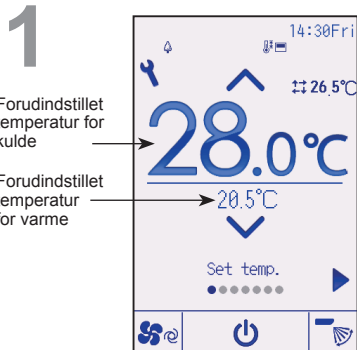



De aktuelle forudindstillede temperaturer vises. Den forudindstillede temperatur for kulde og varme skifter for hvert tryk på - eller -knappen.

2

Forudindstillet temperatur for kulde

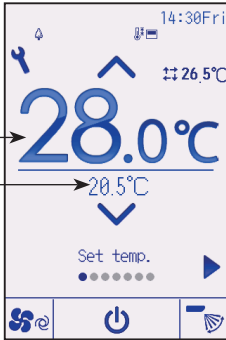
Forudindstillet temperatur for varme



Tryk på -knappen for at reducere den forudindstillede temperatur, og tryk på -knappen for at øge den.

- I tabellen nedenfor kan du se det temperaturområde, der kan indstilles, for de forskellige funktionstilstande.
- De forudindstillede temperaturindstillinger for kulde og varme i indstillingen "Auto" (to indstillingspunkter) anvendes også af indstillingerne "Kulde"/"Tør" og "Varme".
- De forudindstillede temperaturer for kulde og varme i indstillingen "Auto" (to indstillingspunkter) skal opfylde nedenstående betingelser:

- Den forudindstillede temperatur for kulde er højere end den forudindstillede temperatur for varme.
- Kravet for mindste temperaturforskel mellem kulde og varme for forudindstillede temperaturer (varierer med modellerne af de indendørsenheder, der er tilsluttet) er opfyldt.
- Hvis de forudindstillede temperaturer indstilles på en måde, der ikke opfylder kravet for mindste temperaturforskel, ændres begge forudindstillede temperaturer automatisk inden for de tilladte indstillingsområder.

Forudindstillet temperaturområde, der kan indstilles

Funktionstilstand	Forudindstillet temperaturområde
Cool/Dry (Kulde/tør)	19 ~ 30°C (67 ~ 87°F)
Heat (Varme)	17 ~ 28°C (63 ~ 83°F)
Auto (enkelt indstillingspunkt)	19 ~ 28°C (67 ~ 83°F)
Auto (to indstillingspunkter)	[Kulde] Forudindstillet temperaturområde for indstillingen "Kulde". [Varme] Forudindstillet temperaturområde for indstillingen "Varme".
Fan/Ventilation (Ventilator/ventilation)	Kan ikke indstilles

Det temperaturområde, der kan indstilles, varierer efter indendørsenhedsmodel.

Grundfunktioner

Ventilatorhastighed



Hvert tryk med ▼- eller ▲-knappen bladrer gennem følgende ventilatorhastigheder.

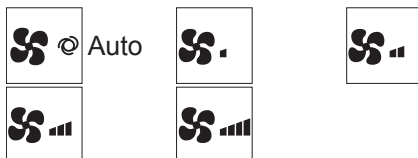

- De tilgængelige ventilatorhastigheder afhænger af, hvilke indendørsenhedsmodeller der er tilsluttet.

Lamelindstilling

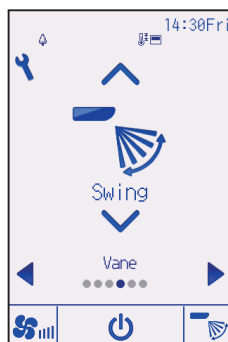

(Prøveskærm på CITY MULTI)

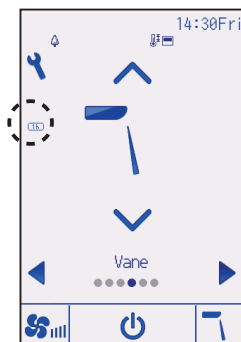

Hvert tryk med ▼- eller ▲-knappen bladrer gennem følgende lamelindstillinger.

Vælg den ønskede indstilling.

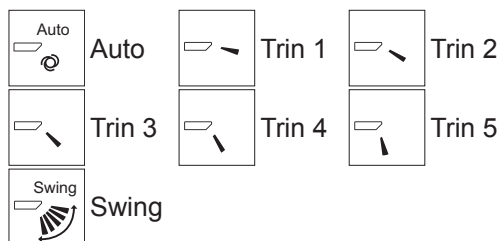

Vælg "Swing" (vippe) for at bevæge lamellerne op og ned automatisk.

Ved indstillingerne "trin 1" til "trin 5" sættes lamellet i den valgte vinkel.

- **1h** til venstre for lamelindstillingsikonet
Dette ikon vises, når lamellet sættes på trin 2, 3, 4 eller 5, og ventilatoren kører ved lav hastighed ved kulde og tør (afhængig af modellen).
Ikonet slukkes efter en time, og lamelindstilling ændres automatisk.

Indstilling af spjæld

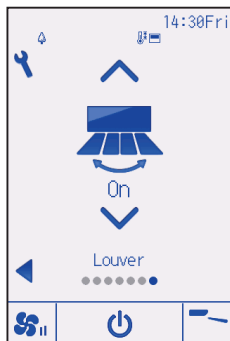

(Prøveskærm på CITY MULTI)

Tryk på knappen ▼ eller ▲ for at tænde eller slukke for spjældvipning.



Indstilling af ventilation

Ventilationsindstilling kan foretages, selvom enhederne er i drift.

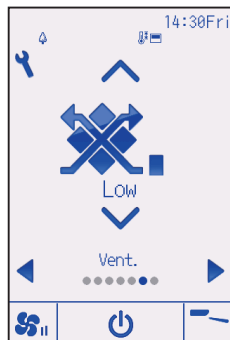

(Prøveskærm på Mr. SLIM)

Hvert tryk med ▼- eller ▲-knappen bladrer gennem følgende ventilationsindstillinger.

* Kan kun indstilles, når Lossnay-enheden er tilsluttet.

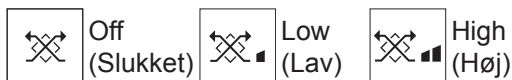

• Ventilatoren på nogle af indendørsenhederne kan være knyttet til nogle af ventilationsenhedsmodellerne.

Sådan navigerer du i menuen

Hovedmenuliste

Hovedmenu	Indstillingselementer		Indstillingsinformation	Side
Operation (Betjening)	High power (Høj effekt)		Bruges til hurtigt at opnå en behagelig rumtemperatur. • Enhederne kan køre i tilstanden høj effekt i op til 30 minutter.	25
	Comfort (Komfort)	Manual vane angle (Manuel lamelvinkel)	Bruges til at fiksere hver lamelvinkel.	26
Timer	Timer	On/Off timer (Tænd-/sluk-timer)	Bruges til at indstille funktionen tænd-/sluk-timer. • Tiden kan indstilles til intervaller på 5 minutter. * Uret skal indstilles.	29
		Auto-Off timer (Autosluk-timer)	Bruges til at indstille auto-/sluk-tiden. • Tiden kan indstilles til en værdi fra 30 til 240 med intervaller på 10 minutter.	32
	Weekly timer (Ugetimer)		Bruges til at indstille ugefunktionen tænd-/sluk-tider. • Der kan indstilles op til otte funktionsmønstre for hver dag. • Der kan indstilles to typer ugentlige skemaer. * Uret skal indstilles. * Ikke gyldig, når tænd-/sluk-timer er aktiveret. * Trin på 1°C	34
	OU silent mode (Driftsenhed lydløs funktion)		Bruges til at indstille de tidsrum, hvor lydløs betjening af udendørsenheder skal prioriteres i forhold til temperaturkontrol. Indstil start-/stoptider for alle ugens dage. • Vælg det ønskede lydløse niveau mellem "normal," "mellem," og "lydløs." * Uret skal indstilles.	37
	Night setback (Natsænkning)		Bruges til at foretage indstilling af natsænkning. • Vælg "Yes" (Ja) for at aktivere indstillingen og "No" (Nej) for at deaktivere indstillingen. Temperaturområdet og start-/stoptider kan indstilles. * Uret skal indstilles. * Trin på 1°C	40
Energy saving (Energi-besparende)	Restriction (Begrænsning)	Temp. range (Temperatur-område)	Bruges til at begrænse det forudindstillede temperaturområde. • Der kan indstilles forskellige temperaturområder for forskellige funktionstilstande. * Trin på 1°C	43
		Operation locked (Betjening låst)	Bruges til at låse de valgte funktioner. • De låste funktioner kan ikke aktiveres.	46
	Energy saving (Energi-besparende)	Auto return (Autoretur)	Bruges til at få enhederne til at køre ved den forudindstillede temperatur efter aktivering af energibesparende funktion i et bestemt tidsrum. • Tiden kan indstilles til en værdi fra 30 og 120 med intervaller på 10 minutter. * Denne funktion er ikke gyldig, når de forudindstillede temperaturområder er begrænsede. * Trin på 1°C	49

Hovedmenu	Indstillingselementer		Indstillingsinformation	Side
Energy saving (Energibesparende)	Energy saving (Energibesparende)	Schedule (Tidsplan)	<p>Indstil start-/stop-tider til at køre enhederne i energibesparende funktionstilstand alle ugens dage og indstille den energibesparende hastighed.</p> <ul style="list-style-type: none"> • Der kan indstilles op til fire energibesparende funktionsmønstre for hver dag. • Tiden kan indstilles til intervaller på 5 minutter. • Den energibesparende hastighed kan indstilles til en værdi fra 0% og 50 til 90% i intervaller på 10%. <p>* Uret skal indstilles.</p>	51
Initial setting (Standardindstilling)	Basic setting (Basisindstilling)	Clock (Ur)	Bruges til at indstille den aktuelle tid.	54
		Daylight saving time (Sommertid)	Indstiller sommertiden.	56
	Display setting (Displayindstilling)	Main display (Hoveddisplay)	Bruges til at skifte mellem "Full" (komplet) og "Basic" (enkelt) funktion for statusdisplay og hoveddisplay. • Standardindstillingen er "Full" (komplet).	58
		Brightness (Lysstyrke)	Bruges til at justere skærmens lysstyrke.	61
		Language selection (Valg af sprog)	Bruges til at vælge det ønskede sprog.	62
		Design	Bruges til at ændre farven på statusdisplay og hoveddisplay.	64
	Touch panel (Touch-panel)	Touch panel calibration (Kalibrering af touch-panel)	Indstiller kalibreringsindstillinger til touch-panelet.	66
		Touch panel cleaning (Rengøring af touch-panel)	Touch-panelet reagerer midlertidigt ikke ved berøring, så det kan rengøres.	68
Service	Initialize remote controller (Initialisering af fjernkontrol)		Bruges til at initialisere fjernkontrollen til fabriksindstilling.	70
	Remote controller information (Oplysninger om fjernkontrolenheden)		Bruges til at vise fjernkontrolenhedens modelnavn, softwareversion og serienummer.	72
Maintenance (Vedligeholdelse)	Error information (Fejlinformation)		<p>Bruges til at kontrollere fejlinformation, når der opstår en fejl.</p> <ul style="list-style-type: none"> • Fejlkode, fejlkilde, kølemiddeladresse, enhedsmodel, fabrikationsnummer, kontaktinformation (forhandlerens telefonnummer) kan vises. * Enhedsmodellen, fabrikationsnummeret og kontaktinformation skal været registreret i forvejen for at kunne vises. 	74
	Filter information (Filterinformation)		<p>Bruges til at kontrollere filterstatus.</p> <ul style="list-style-type: none"> • Filtersymbolet kan nulstilles. 	78

Sådan navigerer du i menuen

Sådan navigerer du i menuen

Knapbetjening

Få adgang til hovedmenuen



Tryk på **[Indstilling]**-knappen på hoveddisplayet.

Hovedmenuen vises.

Valg af element

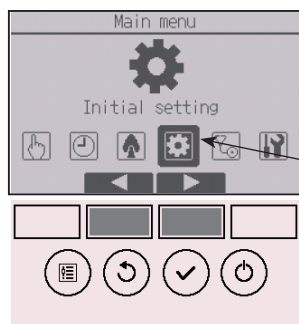

Tryk på **[F2]** for at flytte markøren til venstre.

Tryk på **[F3]** for at flytte markøren til højre.

Markør

Indstilling af funktioner

High power (Høj effekt)



Beskrivelse af funktioner

Med betjeningsfunktionen høj effekt kan enhederne køre med en højere ydeevne end normalt, så indeluften hurtigt kan reguleres til optimal temperatur. Denne procedure varer i op til 30 minutter, hvorefter enheden går tilbage til normal funktionstilstand efter de 30 minutter, eller når rumtemperaturen når den forudindstillede temperatur – alt efter hvad der kommer først. Enhederne går tilbage til normal funktion, når funktionstilstanden eller ventilatorhastigheden ændres.

Knapbetjening

1



Vælg "High power" fra menuen Operation ved kulde, varme eller Auto, og tryk på knappen **VÆLG**.

Funktionen "High power" (høj effekt) er kun mulig på de modeller, der understøtter funktionen.

2

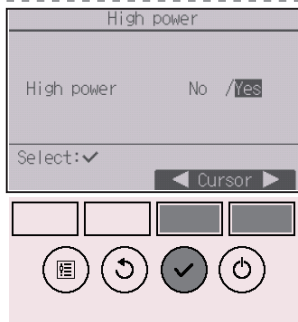

Flyt markøren til "Yes" (Ja) med **F3**- eller **F4**-knappen og tryk på knappen **VÆLG**.

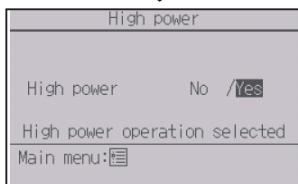

Der vises en bekræftelsesskærm.

Sådan navigerer du i skærmene

- Gå tilbage til hovedmenuen **MENU** knap
- Gå tilbage til den foregående skærm ... **TILBAGE** knap

Indstilling af funktioner

Manual vane angle (Manuel lamelvinkel)

OFF

Knapbetjening

1



Vælg "Comfort" fra menuen Operation, og tryk på knappen **VÆLG**.

2

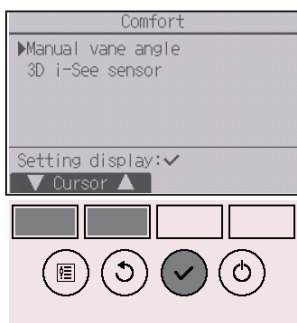

Vælg "Manual vane angle" med **F1**- eller **F2**-knappen og tryk på knappen **VÆLG**.

3



Flyt markøren til "Ref. address" (kølemiddeladresse) eller "Unit No." (enhedsnr.) med **[F1]**-knappen for at vælge.

Vælg kølemiddeladresse og enhedsnummer for de enheder, hvor lamellerne skal fastsættes, med **[F2]**- eller **[F3]**-knappen og tryk på knappen **[VÆLG]**.

- Ref. address: Kølemiddeladresse

- Unit No.: 1, 2, 3, 4

Tryk på **[F4]**-knappen for at bekræfte enheden.

Skærmen til venstre viser et prøvedisplay på Mr. SLIM. På CITY MULTI-enhederne vises "M-NET address" (M-NETadresse) i stedet for "Ref. address" (kølemiddeladresse), og "Unit No." (enhedsnr.) vises ikke.

4

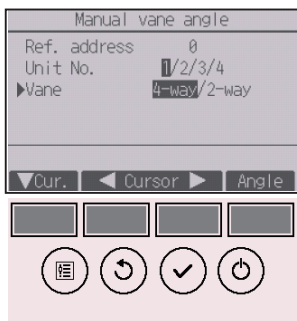

Vælg "Vane" (lamel) med **[F1]**-knappen.

Vælg "4-way" (4-vejs) eller "2-way" (2-vejs) med **[F2]**- eller **[F3]**-knappen og tryk på knappen **[F4]**.

Indstilling af funktioner

5

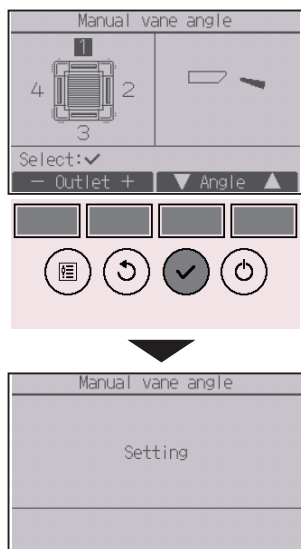

Den aktuelle lamelindstilling vises.

Vælg de ønskede udgange fra "1," "2," "3," "4," eller "1, 2, 3, 4 (alle udgange)" med [F1]- eller [F2]-knappen.

Tryk på [F3]- eller [F4]-knappen for at bladre gennem følgende muligheder, og vælg den ønskede indstilling.

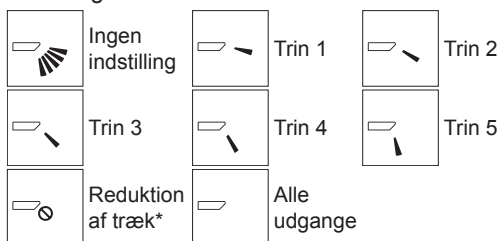

Tryk på knappen [VÆLG] for at gemme indstillingerne.

Der vises en skærm, der viser, at indstillingsinformationen er sendt.

Der foretages indstillingsændringer af de valgte udgange.

Skærmen går automatisk tilbage til det forrige skærmbillede, når overførslen afsluttes.

Foretag indstillinger af de andre udgange efter samme fremgangsmåde.

Hvis alle udgange er valgt, vises  næste gang, enheden tændes.

Sådan navigerer du i skærmene

• Gå tilbage til den foregående skærm [TILBAGE] knap

*Reduktion af træk

Funktionen [Reduktion af træk] holder lamelvinklen mere vandret end viklen i Trin 1, så at luftstrømmen ikke føres direkte mod personerne i lokalet.

Denne funktion kan kun indstilles for én udgang.

Denne funktion kan ikke indstilles på modeller med to eller tre udgange.

I funktionen Reduktion af træk kan luftstrømmen medføre misfarvning af loftet.

Timer (On/Off timer (Tænd-/sluk-timer))



Knapbetjening

1



Vælg "Timer" i hovedmenuen (se side 24), og tryk på knappen **VÆLG**.

On/Off timer (Tænd-/sluk-timeren) virker ikke i følgende tilfælde:

Når On/Off timer (tænd-/sluk-timeren) er slået fra, ved en fejl, ved kontrol (i servicemenuen), ved testkørsel, ved fjernkontroldiagnose, når uret ikke er indstillet, ved indstilling af funktion, når systemet er centralt styret (når anvendelse af "Tænd/sluk" eller "Timer" fra en lokal fjernbetjening ikke er tilladt).

2



Flyt markøren til "Timer", og tryk på knappen **VÆLG**.

3

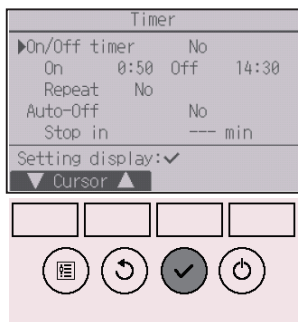

De aktuelle indstillinger vises.

Flyt markøren til "On/Off timer" (tænd-/sluk-timer) og tryk på knappen **VÆLG**.

Indstilling af funktioner

4

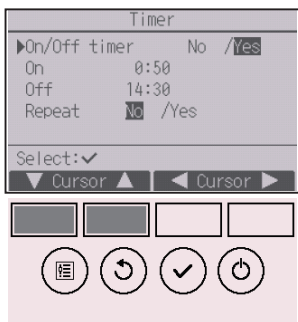

Skærmen til indstilling af timer vises.

Vælg den ønskede enhed med **F1**- eller **F2**-knappen mellem "On/Off timer (tænd-/sluk-timer)," "On (Tænd)," "Off (Slukket)," eller "Repeat (Gentag)."

5

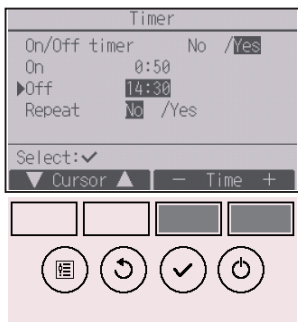

Skift indstilling med **F3**- eller **F4**-knappen.

- On/Off timer (Tænd-/sluk-timer) No (slå fra)/Yes (slå til)
- On (Tændt): Starttid for betjening
(kan indstilles i intervaller på 5 minutter)
 - * Tryk på knappen og hold den nede for hurtigt at gå fremad i tallene.
- Off (Slukket): Stoptid for betjening
(kan indstilles i intervaller på 5 minutter)
 - * Tryk på knappen og hold den nede for hurtigt at gå fremad i tallene.
- Repeat (Gentag): No (én gang)/Yes (gentag)

6

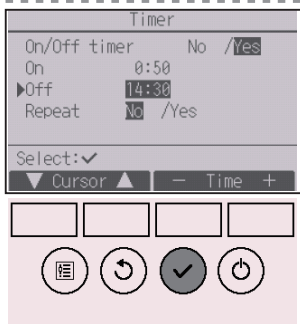

Tryk på knappen **VÆLG** for at gemme indstillingerne.

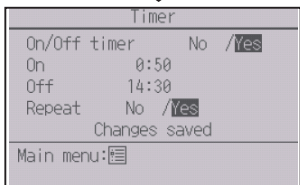



Der vises en bekræftelsesskærm.

Sådan navigerer du i skærmene

- Gå tilbage til hovedmenuen **MENU** knap
- Gå tilbage til den foregående skærm ... **TILBAGE** knap



 vises på hoveddisplay i funktionen komplet, når tænd-/sluk-timeren er slået til.

 vises, når timeren deaktiveres af det centraliserede kontrolsystem.

Indstilling af funktioner

Timer (Auto-Off timer (Autosluk-timer))



Knapbetjening

1

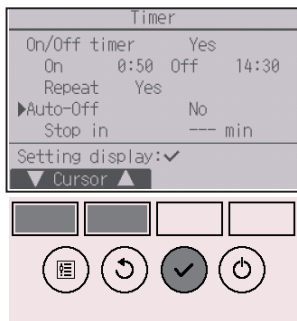

Vis skærmen til indstilling af timer.
(Se side 29.)

Vælg "Auto-Off" (auto-sluk) og tryk på knappen **VÆLG**.

Autosluk-timeren virker ikke i følgende tilfælde:
når Autosluk-timeren deaktiveres, ved fejl, ved kontrol (i servicemenuen), ved prøvekørsel, ved jernkontroldiagnose, ved funktionsindstilling, når systemet styres centralt (når anvendelse af Tænd/sluk eller Timer fra en lokal fjernbetjening ikke er tilladt).

2



De aktuelle indstillinger vises.

Flyt markøren til "Auto-Off" (auto-sluk) eller "Stop in --- min" (stop om --- min) med **F1**- eller **F2**-knappen.

3



Skift indstilling med **F3**- eller **F4**-knappen.

- Auto-Off (Auto-sluk): No (slå fra)/Yes (slå til)
- Stop in --- min (stop om --- min): Timerindstilling (det område, der kan indstilles, er 30 til 240 minutter med intervaller på 10 minutter.)

4



Tryk på knappen **VÆLG** for at gemme indstillingerne.

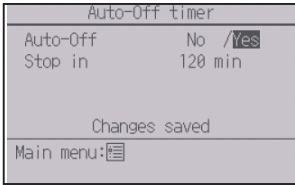



Der vises en bekræftelsesskærm.

Sådan navigerer du i skærmene

- Gå tilbage til hovedmenuen **MENU** knap
- Gå tilbage til den foregående skærm ... **TILBAGE** knap



 vises på statusdisplayet og hoveddisplayet i funktionen komplet, når autosluk-timer er aktiveret.

 vises, når timeren deaktiveres af det centraliserede controlsystem.

Indstilling af funktioner

Weekly timer (Ugetimer)



Knapbetjening

1



Vælg "Weekly timer" fra menuen Timer, og tryk på knappen **VÆLG**.

Weekly timer (Ugetimeren) virker ikke i følgende tilfælde:

Når On/Off timer (tænd-/sluk-timeren) er slået til, når Weekly timer (ugetimeren) er slået fra, ved en fejl, ved kontrol (i servicemenuen), ved testkørsel, ved fjernkontrol diagnose, når uret ikke er indstillet, ved indstilling af funktion, når systemet er centralt styret (anvendelse af Tænd/sluk, temperaturindstilling eller Timer fra en lokal fjernbetjening ikke er tilladt).

2

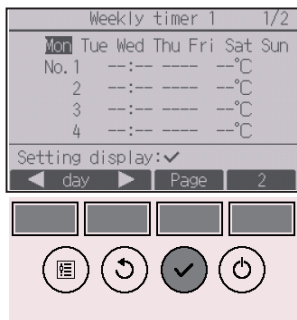

De aktuelle indstillinger vises.

Tryk på **F1**- eller **F2**-knappen for at se indstillinger for hver dag i ugen.

Tryk på **F3**-knappen for at se mønstrene 5 til 8.

Tryk på **F4** for at vise status for Indstilling 2.

Tryk på knappen **VÆLG** for at gå til indstillingsskærmen.

3



Indstillingskærmen for ugetimer vises.

I indstillingen "Action" (Handling) vælges "1" for at aktivere timerindstilling 1, eller vælg "2" for at aktivere timerindstilling 2 med **[F3]**- eller **[F4]**-knappen. Tryk herefter på knappen **[VÆLG]**.

Flyt markøren til "Setting" (Indstilling) med **[F1]**- eller **[F2]**-knappen for at kontrollere indstillingsniveauet for timerindstilling 1 eller 2, og vælg "1" eller "2" med **[F3]**- eller **[F4]**-knappen.

4

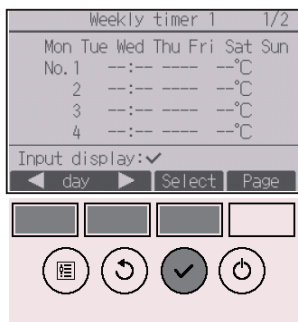

Skærmen til indstilling af weekly timer (ugetimeren) vises, og de aktuelle indstillinger vises.

Der kan indstilles op til otte funktionsmønstre for hver dag.

Flyt markøren til den ønskede dag i ugen med **[F1]**- eller **[F2]**-knappen og tryk på **[F3]**-knappen for at vælge den. (Der kan vælges flere dage.)

Tryk på **[VÆLG]**-knappen.

Indstilling af funktioner

5

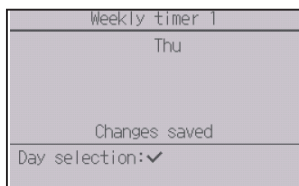
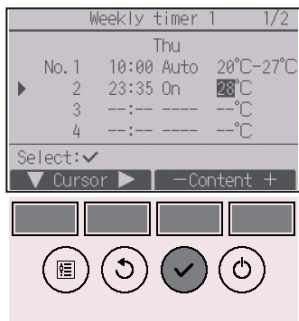

Skærmen til indstilling af funktionsmønstre vises. Tryk på **[F1]**-knappen for at flytte markøren til det ønskede mønsternummer.

Flyt markøren til tid, On/Off (tænd/sluk) eller temperatur med **[F2]**-knappen.

Skift indstillinger med **[F3]**- eller **[F4]**-knappen.

- Tid: kan indstilles i intervaller på 5 minutter
 - * Tryk på knappen og hold den nede for hurtigt at gå fremad i tallene.
- On/Off/Auto (Tænd/Sluk/Auto): Indstillinger, der kan vælges, afhænger af modellen af den tilsluttede indendørsenheder. (Når der udføres et "Auto"-mønster, kører systemet i indstillingen "Auto" (to indstillingspunkter)).
- Temperatur: Det temperaturområde, der kan indstilles, afhænger af de tilsluttede indendørsenheder. (Trin på 1°C) Når indstillingen "Auto" (to indstillingspunkter) er valgt, kan der indstilles to forudindstillede temperaturer. Hvis der udføres et driftsmønster med en enkelt forudindstillet temperatur i indstillingen "Auto" (to indstillingspunkter), anvendes denne indstilling som temperaturindstilling for kulde i indstillingen "Kulde".

Tryk på knappen **[VÆLG]** for at gemme indstillingerne. Der vises en bekræftelsesskærm.

Sådan navigerer du i skærmene

- Gå tilbage til indstillingen skift/ugedag **[VÆLG]** knap
- Gå tilbage til hovedmenuen **[MENU]** knap
- Gå tilbage til den foregående skærm **[TILBAGE]** knap



[7] vises på statusdisplayet og hoveddisplayet i funktionen komplet, når der findes en indstilling af ugetimer for den aktuelle dag.

Ikonet vises ikke, når "Tænd/sluk"-timeren aktiveres, eller systemet styres centralt (anvendelse af "Timer" fra en lokal fjernbetjening er forbudt).

OU silent mode (Driftsenhed lydløs funktion)



Beskrivelse af funktioner

Med denne funktion kan brugeren indstille de tidsrum, hvor lydløs betjening af udendørsenheder skal prioriteres i forhold til temperaturkontrol. Indstil start- og stop tid for hver ugedag til lydløs funktion. Vælg det ønskede lydløse niveau mellem "mellem" og "lydløs".

Knapbetjening

1



Vælg "OU silent mode" fra menuen Timer, og tryk på knappen **VÆLG**.

Funktionen "driftsenhed lydløs funktion" er kun mulig på de modeller, der understøtter funktionen.

2

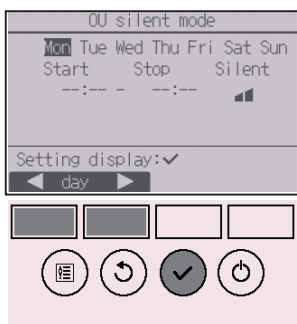

De aktuelle indstillinger vises.

Tryk på **F1**- eller **F2**-knappen for at se indstillinger for hver dag i ugen.

Tryk på knappen **VÆLG** for at gå til indstillingskærmen.

Indstilling af funktioner

3

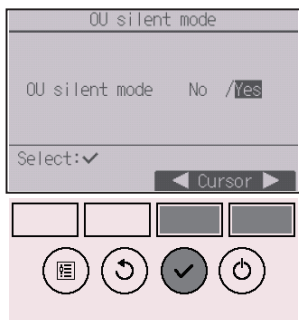

På skærmen til aktivering (Yes) og deaktivering (No) vises lydløs funktion.

For at aktivere denne indstilling flyttes markøren til "Yes" med **F3**- eller **F4**-knappen, og der trykkes på knappen **VÆLG**.

4



Skærmen til indstilling af OU silent mode (driftsenhed lydløs funktion) vises.

For at foretage eller ændre indstilling flyttes markøren til den ønskede dag i ugen med **F1**- eller **F2**-knappen, og der trykkes på **F3**-knappen for at vælge den. (Der kan vælges flere dage.)

Tryk på **VÆLG**-knappen.

5

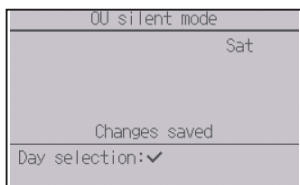
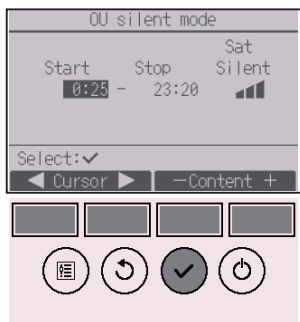

Indstillingskærmen vises.

Flyt markøren til den ønskede enhed med [F1]- eller [F2]-knappen mellem starttid, stoptid eller lydløst niveau.

Skift indstillinger med [F3]- eller [F4]-knappen.

- Start-/stoptid: kan indstilles i intervaller på 5 minutter
 - * Tryk på knappen og hold den nede for hurtigt at gå fremad i tallene.
- Lydløst niveau: Normalt, mellem, lydløst



Tryk på knappen [VÆLG] for at gemme indstillingerne. Der vises en bekræftelsesskærm.

Sådan navigerer du i skærmene

- Gå tilbage til indstillingen skift/ugedag [VÆLG] knap
- Gå tilbage til hovedmenuen [MENU] knap
- Gå tilbage til den foregående skærm [TILBAGE] knap

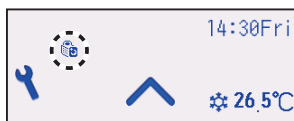

 vises på statusdisplayet og hoveddisplayet i funktionen komplet ved driftsenhed lydløs funktion.

Indstilling af funktioner

Night setback (Natsænkning)



Beskrivelse af funktioner

Denne kontrol starter varmfunktionen, når kontrolgenstandsgruppen stoppes, og rumtemperaturen falder til under den forudindstillede nedre temperaturgrænse. Desuden starter denne kontrol kuldefunktionen, når kontrolgenstandsgruppen stoppes, og rumtemperaturen stiger til over den forudindstillede øvre temperaturgrænse.

Night setback (Natsænkningsfunktionen) er ikke mulig, hvis betjening og indstilling af temperatur foretages fra fjernkontrol.

Hvis rumtemperaturen måles af airconditionlæggets ind sugningstemperaturføler, er det eventuelt ikke muligt at opnå den nøjagtige temperatur, når airconditionlægget er slået fra, eller når luften ikke er ren. I så fald sættes føleren til fjernføler (PAC-SE40TSA/PAC-SE41TS-E) eller en fjernkontrolløler.

Knabetjening

1



Vælg "Night setback" fra menuen Timer, og tryk på knappen **VÆLG**.

2



De aktuelle indstillinger vises.

Tryk på knappen **VÆLG** for at gå til indstillingskærmen.

3

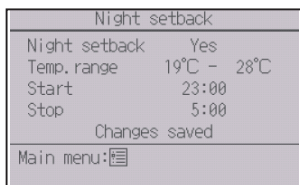

Flyt markøren til den ønskede enhed med [F1]- eller [F2]-knappen mellem Night setback (natsænkning) No (slået fra)/Yes (slået til), Temp. range (temperaturområde), Start time (starttid) eller Stop time (stoptid).

Skift indstillinger med [F3]- eller [F4]-knappen.

- Temp. range (temperaturområde): Den nedre temperaturgrænse (for opvarmning) og den øvre temperaturgrænse (for afkøling) kan indstilles. Temperaturforskellen mellem den nedre og øvre grænse skal være 4°C (8°F) eller derover. Det temperaturområde, der kan indstilles, afhænger af de tilsluttede indendørsenheder.
* Trin på 1°C

- Start/Stop time (Start-/stoptid): kan indstilles i intervaller på 5 minutter
* Tryk på knappen og hold den nede for hurtigt at gå fremad i tallene.

Tryk på knappen [VÆLG] for at gemme indstillingerne. Der vises en bekræftelsesskærm.

Sådan navigerer du i skærmene

- Gå tilbage til hovedmenuen [MENU] knap
- Gå tilbage til den foregående skærm [TILBAGE] knap

Indstilling af funktioner



 vises på statusdisplayet og hoveddisplayet i funktionen komplet, når natsænkingsfunktionen er slået til.

 vises, når timeren deaktiveres af det centraliserede kontrolsystem.

Natsækning fungerer ikke i følgende tilfælde:

Når enheden er i brug, når natsænkingsfunktionen er slået fra, ved en fejl, ved kontrol (i servicemenuen), ved testkørsel, ved fjernkontrol diagnose, når uret ikke er indstillet, ved indstilling af funktion, når systemet er centralt styret (anvendelse af Tænd/sluk, temperaturindstilling eller Timer fra en lokal fjernbetjening ikke er tilladt).

Indstilling af begrænsning af temperaturområde

Knapbetjening

1



Vælg "Energy saving" i hovedmenuen (se side 24) og tryk på knappen **VÆLG**.

2

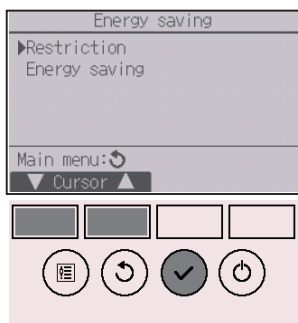

Flyt markøren til "Restriction" med **F1**- eller **F2**-knappen og tryk på knappen **VÆLG**.

Indstilling af funktioner

3

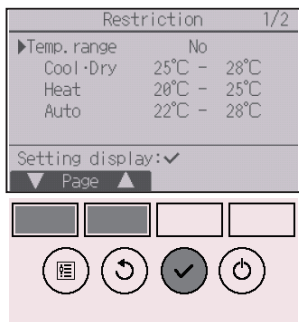

De aktuelle indstillinger vises.

Flyt markøren til "Temp. range" (temperaturområde) med **F1**- eller **F2**-knappen og tryk på knappen **VÆLG**.

4

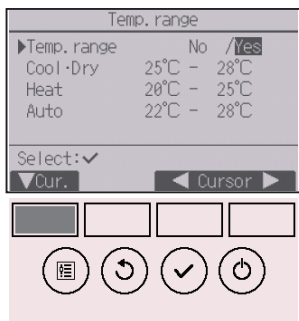

Skærmen til indstilling af temperaturområdet vises.

Flyt markøren til den ønskede enhed med **F1**-knappen mellem "Temp. range" (temperaturområde), "Cool-Dry" (kulde•tør), "Heat" (varme) eller "Auto".

5

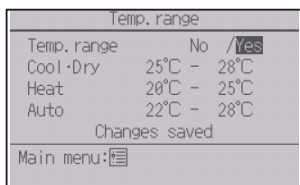
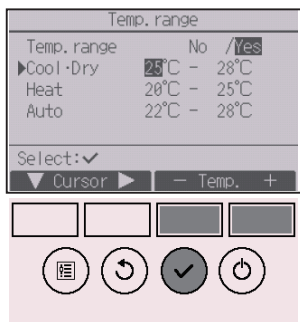

Skift indstillinger med **[F3]**- eller **[F4]**-knappen.

- Temp. range (temperaturområde): Nej (ubegrænset) eller Ja (begrænset)
- Cool-Dry (Kulde•Tør): Øvre og nedre temperaturgrænse (Trin på 1°C)
- Heat (Varme): Øvre og nedre temperaturgrænse (Trin på 1°C)
- Auto: Øvre og nedre temperaturgrænse (Trin på 1°C)

Temperaturindstillinger

Funktionstilstand	Nedre grænse	Øvre grænse
Cool•Dry (Kulde•Tør) *1 *3	19 ~ 30°C (67 ~ 87°F)	30 ~ 19°C (87 ~ 67°F)
Heat (Varme) *2 *3	17 ~ 28°C (63 ~ 83°F)	28 ~ 17°C (83 ~ 63°F)
Auto *4	19 ~ 28°C (67 ~ 83°F)	28 ~ 19°C (83 ~ 67°F)

* Det område, der kan indstilles, afhænger af den tilsluttede enhed.

*1 Der kan indstilles temperaturområder for indstillingerne "Kulde", "Tør" og "Auto" (to indstillingspunkter).

*2 Temperaturområderne for indstillingerne "Varme" og "Auto" (to indstillingspunkter) kan indstilles.

*3 Temperaturområderne for indstillingerne "Varme", "Kulde" og "Tør" skal opfylde nedenstående betingelser:

- Øvre grænse for kulde - øvre grænse for varme \geq Mindste temperaturforskel (varierer med model af indendørsenhed)
- Nedre grænse for kulde - nedre grænse for varme \geq Mindste temperaturforskel (varierer med model af indendørsenhed)

*4 Temperaturområdet for indstillingen "Auto" (enkelt indstillingspunkt) kan indstilles.

Tryk på knappen **[VÆLG]** for at gemme indstillingerne. Der vises en bekræftelsesskærm.

Sådan navigerer du i skærmene

- Gå tilbage til hovedmenuen **[MENU]** knap
- Gå tilbage til den foregående skærm **[TILBAGE]** knap



 vises på statusdisplayet og hoveddisplayet i funktionen komplet, når temperaturområdet er begrænset.

Indstilling af funktioner

Restriction (Begrænsning)



Betjeningslåsfunktion

Knapbetjening

For at aktivere funktionen betjeningslås indstilles "Operation locked" (betjening låst) til "Yes" (Ja).

1

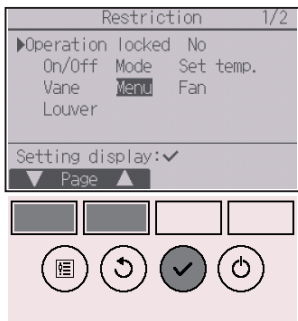

Vis skærmen til indstilling af Restriction. (Se side 43.)

Flyt markøren til "Operation locked" (betjening låst) og tryk på knappen **VÆLG**.

2

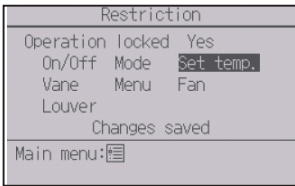

Skærmen til indstilling af betjeningslåsfunktion vises.

Flyt markøren til den ønskede enhed med [F1]- eller [F2]-knappen mellem "Operation locked" (betjening låst), "Location" (placering), "On/Off" (tænd/sluk), "Mode" (funktionstilstand), "Set temp." (indstil temperatur), "Menu", "Fan" (ventilator), "Louver" (spjæld) eller "Vane" (lamel).

Skift indstillinger med [F3]- eller [F4]-knappen.

- Operation locked: No (slå fra)/Yes (slå til)
- Location: "Individual" (individuel) eller "Hotel"
- On/Off: Tænd/sluk
- Mode: Indstilling af funktionstilstand "–" / "Locked" (låst)
- Set temp.: Indstilling af forudindstillet temperatur
- Vane: Lamelindstilling
- Menu: Menuindstilling
- Fan: Indstilling af ventilatorhastighed
- Louver: Indstilling af spjæld

Når "Hotel" vælges til indstillingen "Location", er følgende funktioner automatisk låst: Mode, Vane, Menu og Louver.

Tryk på knappen [VÆLG] for at gemme indstillingerne. Der vises en bekræftelsesskærm.

Sådan navigerer du i skærmene

- Gå tilbage til hovedmenuen [MENU] knap
- Gå tilbage til den foregående skærm [TILBAGE] knap

Indstilling af funktioner



 vises på statusdisplayet og hoveddisplayet i funktionen komplet, når indstilling af betjeningslås er slået til.

Betjeningsvejledning, der svarer til den låste funktion, stoppes.

Tryk på og hold **Indstilling**-knappen nede i ti eller flere sekunder for at vise hovedmenuen, mens menuindstilling er låst. Indtast administratoradgangskoden på skærmen.

Energy saving (Energibesparende)



Går automatisk tilbage til den forudindstillede temperatur

Efter funktionen Autoretur er aktiveret, når funktionstilstanden ændres eller TÆND/SLUK-funktionen udføres fra denne fjernkontrol, vender den indstillede temperatur automatisk tilbage til den ønskede temperatur, uanset det indstillede tidspunkt.

Knapbetjening

1

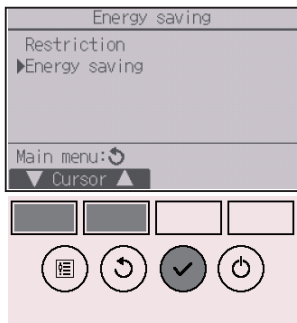

Vælg "Energy saving" fra menuen Energy saving, og tryk på knappen **VÆLG**.

2

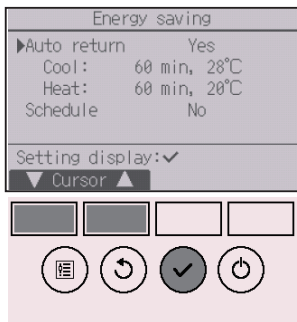

De aktuelle indstillinger vises.

Flyt markøren til "Auto return" (autoretur) med **F1**- eller **F2**-knappen og tryk på knappen **VÆLG**.

Indstilling af funktioner

3

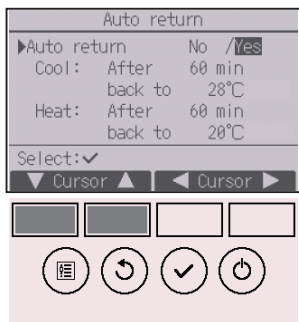

Skærmen til indstilling af automatisk retur til forudindstillet temperatur vises.

Flyt markøren til den ønskede enhed med **[F1]**- eller **[F2]**-knappen mellem "Auto return" (autoretur), "Cool" (kulde) eller "Heat" (varme).

4

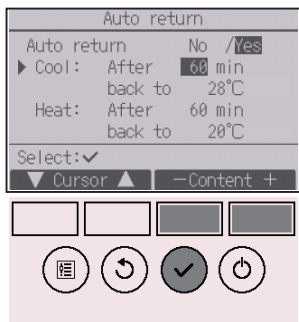

Skift indstillinger med **[F3]**- eller **[F4]**-knappen.

- Auto return (Autoretur): No (slå fra)/Yes (slå til)
- Cool (Kulde): Timerindstillingsområdet er 30 til 120 minutter med intervaller på 10 minutter. Temperaturindstillingsområdet er 19 til 30°C (67 til 87°F). (Trin på 1°C)
- Heat (Varme): Timerindstillingsområdet er 30 til 120 minutter med intervaller på 10 minutter. Temperaturindstillingsområdet er 17 til 28°C (63 til 83°F). (Trin på 1°C)

Tryk på knappen **[VÆLG]** for at gemme indstillingerne. "Cool" (Kulde) omfatter "Dry" (Tør) og "Auto Cool" (Auto kulde), og "Heat" (Varme) omfatter "Auto Heat" (Auto varme).

Skærmen til indstilling af den valgte enhed vises.

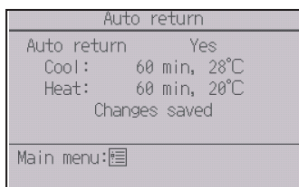

Sådan navigerer du i skærmene

- Gå tilbage til hovedmenuen **[MENU]** knap
- Gå tilbage til den foregående skærm **[TILBAGE]** knap

Indstillinger for Timer eller Forudindstillet temperatur virker ikke, når temperaturområdet er begrænset, og når systemet styres centralt (når indstilling af temperaturområde fra en lokal fjernbetjening er forbudt). Når systemet styres centralt (når anvendelse af "Timer" fra en lokal fjernbetjening er forbudt), er det kun indstillingen "Timer", der ikke virker.

Indstilling af energibesparende tidsplan

Knapbetjening

1

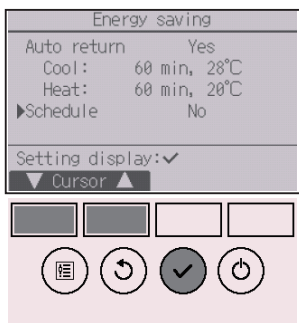

Vis skærmen til "Energy saving". (Se side 49.)

Flyt markøren til "Schedule" (tidsplan), og tryk på knappen **VÆLG**.

2

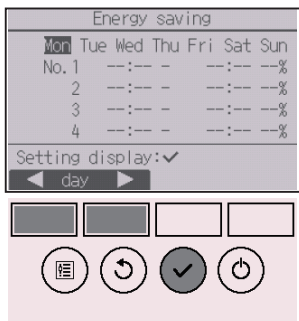

Skærmen til visning af tidsplan vises.

Tryk på **F1**- eller **F2**-knappen for at se indstillinger for hver dag i ugen.

Tryk på knappen **VÆLG** for at gå til indstillingsskærmen.

3

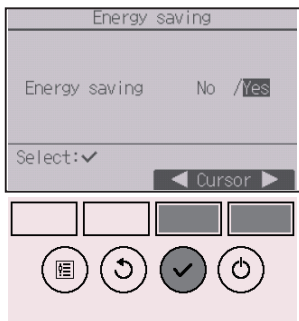

På skærmen til aktivering (Yes) og deaktivering (No) vises tidsplan for energibesparende drift.

Vælg "No" eller "Yes" med **F3**- eller **F4**-knappen.

Tryk på knappen **VÆLG** for at gå til skærmen for valg af indstillingen skift/ugedag.

Indstilling af funktioner

4



Skærmen til valg af indstillingen skift/ugedag vises. Der kan indstilles op til fire funktionsmønstre for hver dag.

Flyt markøren til den ønskede dag i ugen med [F1]- eller [F2]-knappen og tryk på [F3]-knappen for at vælge den. (Der kan vælges flere dage.)

Tryk på knappen [VÆLG] for at gå til skærmen for indstilling af mønster.

5

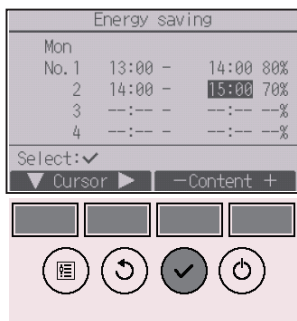

Skærmen til indstilling af mønster vises.

Tryk på [F1]-knappen for at flytte markøren til det ønskede mønsternummer.

Flyt markøren til den ønskede enhed med [F2]-knappen mellem starttid, stoptid og energibesparende hastighed (vist i denne rækkefølge fra venstre).

Skift indstillinger med [F3]- eller [F4]-knappen.

- Start-/stoptid: kan indstilles i intervaller på 5 minutter
- * Tryk på knappen og hold den nede for hurtigt at gå fremad i tallene.
- Energibesparende: Indstillingsområdet er 0% og 50 til 90% med intervaller på 10%.

Tryk på knappen [VÆLG] for at gemme indstillingerne. Der vises en bekræftelsesskærm.

Jo lavere værdien er, jo større er den energibesparende effekt.



 vises på statusdisplayet og hoveddisplayet i funktionen komplet, når enheden kører i energibesparende tilstand.

Sådan navigerer du i skærmene

- Gå tilbage til indstillingen skift/ugedag **VÆLG** knap
- Gå tilbage til hovedmenuen **MENU** knap
- Gå tilbage til den foregående skærm **TILBAGE** knap

Indstilling af funktioner

Clock (Ur)



Knapbetjening

1

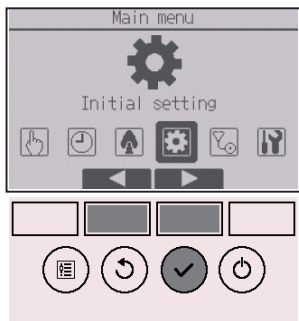

Vælg "Initial setting" i hovedmenuen (se side 24) og tryk på knappen **VÆLG**.

Uret skal indstilles, inden følgende indstillinger kan foretages.

- On/Off timer (Tænd-/sluk-timer)
- OU silent mode (Driftsenhed lydløs funktion)
- Night setback (Natsænkning)
- Weekly timer (Ugetimer)
- Energy saving (Energibesparende)

Hvis et bestemt system ikke har systemkontrolenheder, bliver urtiden ikke automatisk korrigeret. Korriger i så fald urtiden regelmæssigt.

2

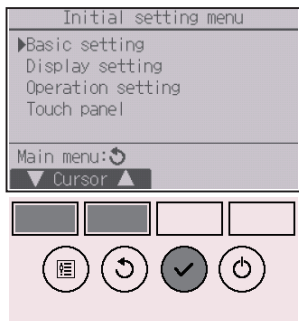

Flyt markøren til "Basic setting" med **F1**- eller **F2**-knappen og tryk på knappen **VÆLG**.

3



Vælg "Clock" med **F1**- eller **F2**-knappen og tryk på knappen **VÆLG**.

4



Flyt markøren til "Clock" med **[F1]**- eller **[F2]**-knappen og tryk på knappen **[VÆLG]**.

5



Flyt markøren til den ønskede enhed med **[F1]**- eller **[F2]**-knappen mellem år, måned, dato, time eller minut.

Forøg eller reducer værdien for den valgte enhed med **[F3]**- eller **[F4]**-knappen og tryk på knappen **[VÆLG]**.

Der vises en bekræftelsesskærm.

Sådan navigerer du i skærmene

- Gå tilbage til hovedmenuen **[MENU]** knap
- Gå tilbage til den foregående skærm **[TILBAGE]** knap

Indstilling af funktioner

Daylight saving time (Sommertid)



Beskrivelse af funktioner

Sommertidens start-/sluttid kan indstilles. Funktionen for sommertid bliver aktiveret ud fra indstillingsindholdet.

- Hvis et bestemt system har en systemkontrolenhed, bør du deaktivere denne indstilling for at bevare den korrekte tid.
- I starten og slutningen af sommertid kan timeren gå i gang to gange eller slet ikke.
- Denne funktion virker ikke, med mindre uret er blevet indstillet.

Knapbetjening

1

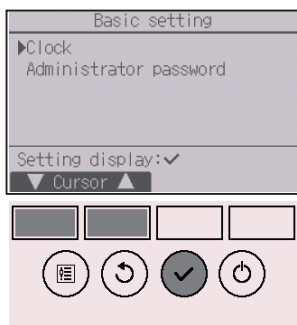

Vælg "Clock" fra menuen Basic setting, og tryk på knappen **VÆLG**.

2



Flyt markøren til "Daylight saving time" med **F1**- eller **F2**-knappen og tryk på knappen **VÆLG**.

3

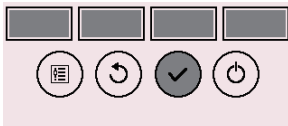
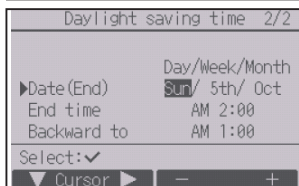
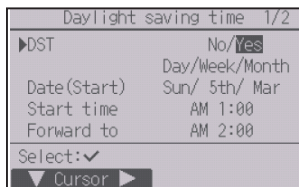

Flyt cursoren til følgende elementer med **[F1]**-knappen for at foretage indstillingerne.

- **DST (Sommertid)**
Vælg "No" (deaktiver) eller "Yes" (aktiver) med **[F2]**-knappen. Standardindstillingen er "No".
- **Date(Start) (Startdag)*1**
Indstil ugedagen, ugenummeret og måneden med **[F3]**- eller **[F4]**-knappen. Standardindstillingen er "Sun/5th/Mar" (Søn/5./mar).
- **Start time (Starttid)**
Indstil starttiden for sommertid med **[F3]**- eller **[F4]**-knappen.
- **Forward to (Stil frem til)**
Indstil tiden, hvor uret skal stilles frem til, ved starttiden ovenover med **[F3]**- eller **[F4]**-knappen.
- **Date(End) (Slutdato)*1 (2.-side)**
Indstil ugedagen, ugenummeret og måneden med **[F3]**- eller **[F4]**-knappen. Standardindstillingen er "Sun/5th/Oct" (Søn/5./okt).
- **End time (Sluttid) (2.-side)**
Indstil sluttiden for sommertid med **[F3]**- eller **[F4]**-knappen.
- **Backward to (Stil tilbage til) (2.-side)**
Indstil tiden, hvor uret skal stilles tilbage til, ved sluttiden ovenover med **[F3]**- eller **[F4]**-knappen.

*1 Hvis der vælges "5th (5.)" for ugenummeret, og den 5. uge ikke findes i den valgte måned af året, anses indstillingen til at være "4th (4.)"

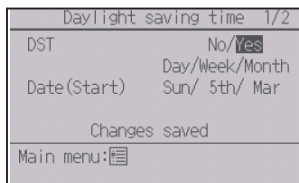

Tryk på knappen **[VÆLG]** for at gemme indstillingerne. Der vises en bekræftelsesskærm.

Sådan navigerer du i skærmene

- Gå tilbage til hovedmenuen **[MENU]** knap
- Gå tilbage til den foregående skærm **[TILBAGE]** knap

Indstilling af funktioner

Main display (Hoveddisplay)



Knapbetjening

1



Vælg "Display setting" fra menuen Initial setting, og tryk på knappen **VÆLG**.

2

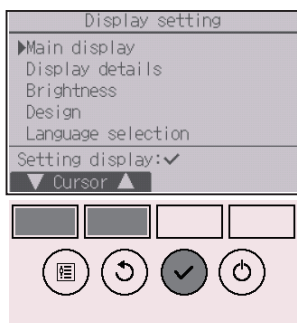

Flyt markøren til "Main display" med **F1**- eller **F2**-knappen og tryk på knappen **VÆLG**.

3

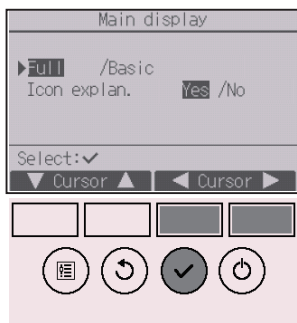

Vælg "Full" (komplet) eller "Basic" (enkel) (se side 10) med **F3**- eller **F4**-knappen og tryk på knappen **VÆLG**.

Der vises en bekræftelsesskærm.

Sådan navigerer du i skærmene

- Gå tilbage til hovedmenuen **MENU** knap
- Gå tilbage til den foregående skærm **TILBAGE** knap

Knapbetjening

1



Vælg "Display setting" fra menuen Initial setting, og tryk på knappen **VÆLG**.

2

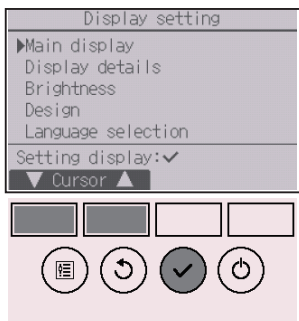

Flyt markøren til "Main display" med **F1**- eller **F2**-knappen og tryk på knappen **VÆLG**.

3

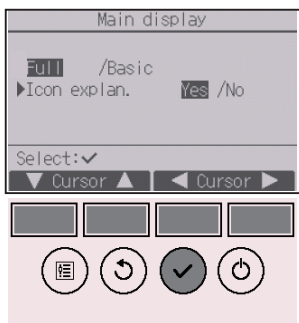

Vælg "Icon explan." med **F1**- eller **F2**-knappen, vælg den ønskede indstilling "Yes" (Ja) eller "No" (Nej) med **F3**- eller **F4**-knappen, og tryk på **VÆLG**-knappen.
Standardindstillingen er "Yes" (Ja).

Sådan navigerer du i skærmene

- Gå tilbage til hovedmenuen **MENU** knap
- Gå tilbage til den foregående skærm **TILBAGE** knap

Indstilling af funktioner

4

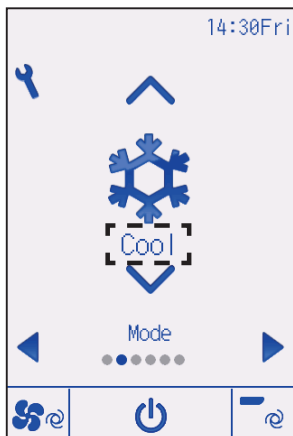

Når "Yes" (Ja) er valgt, vises ikonforklaringen for indstillingselementer som vist til venstre.

Brightness (Lysstyrke)



Knapbetjening

1



Vælg "Display setting" fra menuen Initial setting, og tryk på knappen **VÆLG**.

2

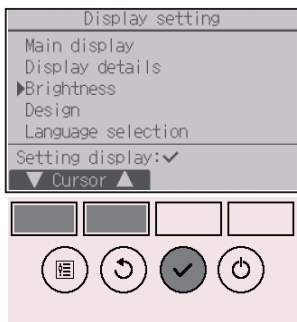

Flyt markøren til "Brightness" med **F1**- eller **F2**-knappen og tryk på knappen **VÆLG**.

3



Skift lysstyrken med **F1**- eller **F2**-knappen. "ON" (Tændt) eller "OFF" (Slukket) kan vælges til indstillingen "Stay lit" (Forbliv tændt) med **F4**-knappen.

Når "ON" (Tændt) er valgt, lyser bagbelysningen svagt, selv når det angivne tidsrum er gået.

Sådan navigerer du i skærmene

- Gå tilbage til hovedmenuen **MENU** knap
- Gå tilbage til den foregående skærm **TILBAGE** knap

Indstilling af funktioner

Language selection (Valg af sprog)



Beskrivelse af funktioner

Det ønskede sprog kan indstilles. Der kan vælges mellem engelsk, fransk, tysk, spansk, italiensk, portugisisk, svensk, russisk, græsk, tyrkisk, hollandsk, tjekkisk, ungarsk og polsk.

Knapbetjening

1



Vælg "Display setting" fra menuen Initial setting, og tryk på knappen **VÆLG**.

2

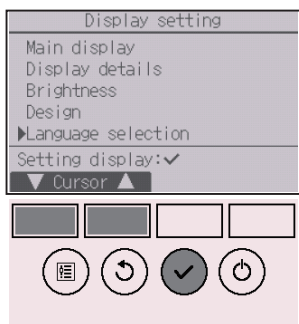

Flyt markøren til "Language selection" med **F1**- eller **F2**-knappen og tryk på knappen **VÆLG**.

3

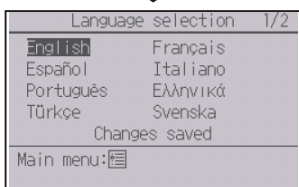
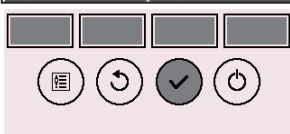
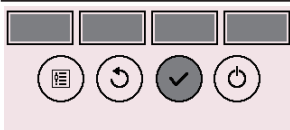

Flyt markøren til det sprog, du ønsker, med knapperne [F1] til [F4], og tryk på knappen [VÆLG] for at gemme indstillingen.

Når der er tændt for strømmen for første gang, vises skærmen til Language selection (valg af sprog). Vælg det ønskede sprog. Systemet starter ikke, medmindre der vælges et sprog.

Der vises en skærm, der fortæller, at indstillingsinformationen er sendt.

Sådan navigerer du i skærmene

- Gå tilbage til hovedmenuen [MENU] knap
- Gå tilbage til den foregående skærm [TILBAGE] knap

Indstilling af funktioner

Design



Knapbetjening

1



Vælg "Display setting" fra menuen Initial setting, og tryk på knappen **VÆLG**.

2

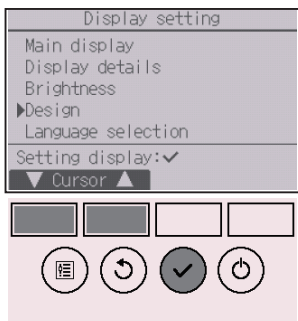

Flyt markøren til "Design" med **F1**- eller **F2**-knappen og tryk på knappen **VÆLG**.

3



Vælg "Farve" med **F4**-knappen.

- Color (Farve): Displayfarven kan vælges. (Der henvises til næste side).
- White (Hvid): Monokromt display (hvid basis)
- Black (Sort): Monokromt display (sort basis)

Tryk på knappen **VÆLG**, når "White" eller "Black" er valgt. Når "Color" er valgt, vælges den ønskede farve vha. næste side.

4



Vælg følgende element med **F1**- eller **F2**-knappen, og indstil den ønskede displayfarve for hvert element.

- Color (Farveskygge): Indstil farveskyggen med **F3**- eller **F4**-knappen. (Der kan indstilles et område mellem -90 og 89).
- Pattern (Mønster): Indstil en farve med **F4**-knappen.
- Color set to (Farve indstillet til): Vælg "Character" (tegn) eller "BG" (baggrund) som et mål, som farven anvendes til med **F4**-knappen.

Farveprøven under funktionsknapperne ændres i henhold til indstillingen.

Indstil den ønskede farve, og tryk på knappen **VÆLG**.

Sådan navigerer du i skærmene

- Gå tilbage til hovedmenuen **MENU** knap
- Gå tilbage til den foregående skærm **TILBAGE** knap

Indstilling af funktioner

Touch panel calibration (Kalibrering af touch-panel)



Knapbetjening

1



Vælg "Touch panel" fra menuen Initial setting, og tryk på knappen **VÆLG**.

2



Flyt markøren til "Touch panel calibration" med **F1**- eller **F2**-knappen og tryk på knappen **VÆLG**.

3



Der vises en bekræftelsesskærm. Vælg "Cancel" (Annuller) eller "OK" med **F3**- eller **F4**-knappen og tryk på knappen **VÆLG**.

4

Touch the black dots in the order they appear on the screen. There will be nine of them all together.

Touch the black dots with a touch pen in a minute, starting from the topleft corner.

Tryk på de ni sorte prikker i den rækkefølge, som de fremkommer på skærmen.

Når der er trykket på alle ni prikker, er kalibreringen færdig, og displayet vender tilbage til touch-panelmenuen.

- Hvis ikke der trykkes på touch-panelet i et minut, bliver kalibreringen annulleret, og displayet vender automatisk tilbage til den forrige skærm.
- Brug en spids men ikke skarp genstand til at trykke på prikkerne for at kalibrere touch-panelet korrekt.
 - * En skarp genstand kan beskadige eller ridse touch-panelet.

Indstilling af funktioner

Touch panel cleaning (Rengøring af touch-panel)



Knapbetjening

1

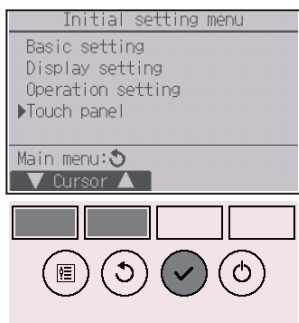

Vælg "Touch panel" fra menuen Initial setting, og tryk på knappen **VÆLG**.

2



Flyt markøren til "Touch panel cleaning" med **F1**- eller **F2**-knappen og tryk på knappen **VÆLG**.

3



Der vises en bekræftelsesskærm. Vælg "Cancel" (Annuller) eller "OK" med **F3**- eller **F4**-knappen og tryk på knappen **VÆLG**.

4



Denne skærm lader brugeren tørre touch-panelet af i 30 sekunder uden utilsigtet at komme til at ændre indstillingerne.

Displayet vender tilbage til touch-panelmenuen efter 30 sekunder.

- Aftør med en blød tør klud, en klud vædet med vand og mildt rengøringsmiddel eller en klud fugtet med ethanol. Der må ikke bruges syreholdige, alkaliske eller organiske opløsningsmidler.

Indstilling af funktioner

Initialize remote controller (Initialisering af fjernkontrol)



Beskrivelse af funktioner

Fjernkontrollenheden kan initialiseres til fabriksindstillingen. Bemærk at følgende data initialiseres. Fjernkontrollenheden starter automatisk op efter initialisering.

Timerindstilling, indstilling af ugetimer, indstilling af driftsenhed lydløs funktion, energibesparende indstilling, indstilling af energibesparende mulighed, urindstilling, indstilling af sommertid, indstilling af hoveddisplay, indstilling af lysstyrke, indstilling af displaydetaljer, designindstilling, indstilling af automatisk tilstand, indstilling af modelnavn, indstilling af serienummer, indstilling af forhandlerinformation, fejlinformation, administratoradgangskode, vedligeholdelsesadgangskode

Knapbetjening

1



Vælg "Others" fra menuen Service, og tryk på knappen **VÆLG**.

2



Flyt markøren til "Initialize remote controller" med **F1**- eller **F2**-knappen og tryk på knappen **VÆLG**.

3

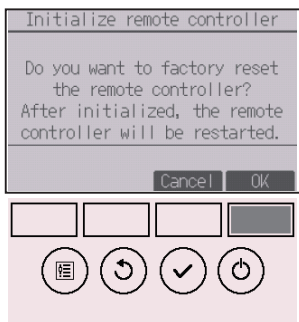

Vælg "OK" med **[F4]**-knappen.

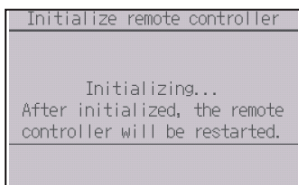

Fjernkontrolenheden starter automatisk op efter initialisering.

Indstilling af funktioner

Remote controller information (Oplysninger om fjernkontrollenheden)



Beskrivelse af funktioner

Oplysningerne om den anvendte fjernkontrollenhed kan kontrolleres.

Knapbetjening

1



Vælg "Others" fra menuen Service, og tryk på knappen **VÆLG**.

2

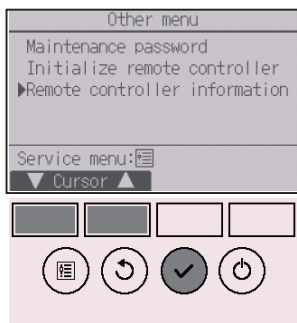

Flyt markøren til "Remote controller information" med **F1**- eller **F2**-knappen og tryk på knappen **VÆLG**.

3

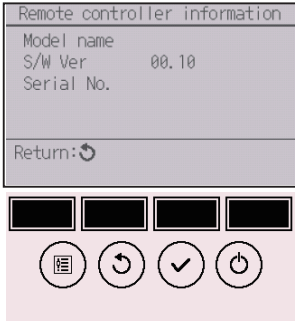

Fjernkontrollenhedens modelnavn, softwareversion og serienummer kan kontrolleres.

Fejlfinding

Error information (Fejlinformation)

Når der opstår en fejl, vises følgende skærm, og drifts-LED blinker. Kontrollér fejlstatus, stop enheden og henvend dig til din forhandler.

Knapbetjening

1

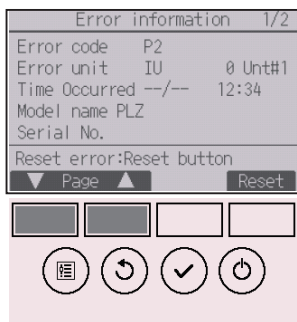

Fejlkode, fejlenhed, kølemiddeladresse, enhedens modelnavn, dato og tidspunkt for den opståede fejl og serienummer vises.

Modelnavnet og serienummeret vises kun, hvis disse oplysninger er blevet registreret.

Tryk på **[F1]**- eller **[F2]**-knappen for at gå til næste side.

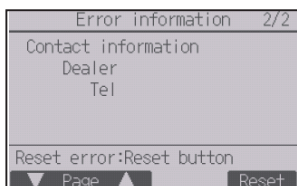

Kontaktinformation (forhandlerens telefonnummer) vises, hvis oplysningerne er blevet registreret.

2

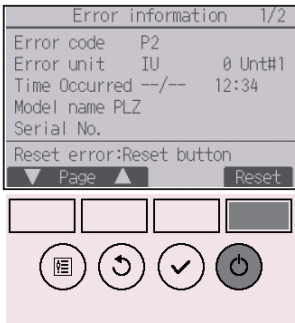

Tryk på **[F4]**-knappen eller **[TÆND/SLUK]**-knappen for at nulstille den opståede fejl.

Fejl kan ikke nulstilles, når funktionen TÆND-/SLUK ikke er mulig.

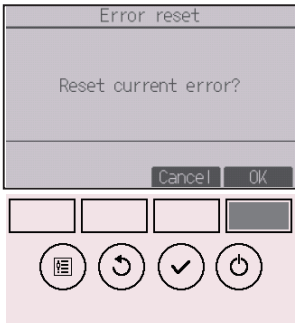

Vælg "OK" med **[F4]**-knappen.

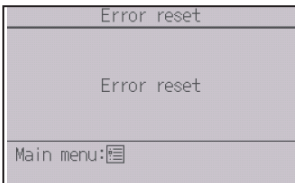

Der vises en bekræftelsesskærm.

Sådan navigerer du i skærmene

- Gå tilbage til hovedmenuen **[MENU]** knap

Fejlfinding

Kontrollér fejlinformation

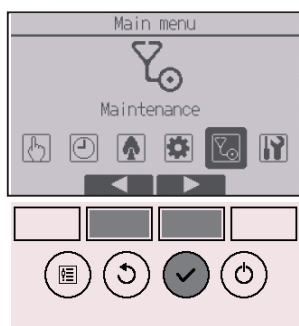

Når der ikke er nogen fejl, kan man se side 2/2 af fejlinformationen (se side 74) fra menufunktionen. Vælg menuen "Maintenance" fra hovedmenuen, og tryk på knappen **VÆLG**.

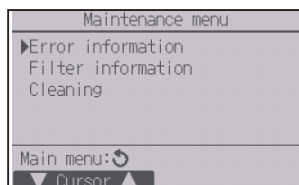

Vælg "Error information" fra menuen Maintenance for at vise skærmen med fejlinformation. Fejl kan ikke nulstilles.

No occupancy Auto-OFF (Automatisk slukning ved mangel på aktivitet)

Følgende skærbillede vises for 3D i-See sensor panelmodel, når enheden stopper på grund af Automatisk slukning ved mangel på aktivitet-funktionen under den energibesparende mulighed.

Se instruktionsbogen for indendørsenheden angående indstilling af 3D i-See sensor.

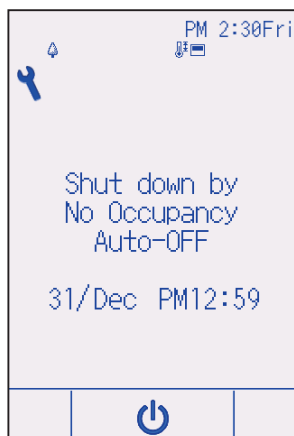

Vedligeholdelse

Filter information (Filterinformation)



 vises på statusdisplayet og hoveddisplayet i funktionen komplet, når filtrene skal rengøres.

Vask, rengør eller udskift filtrene, når dette symbol vises.

Se yderligere information i instruktionsvejledningen for indendørsenheden.

Knapbetjening

1

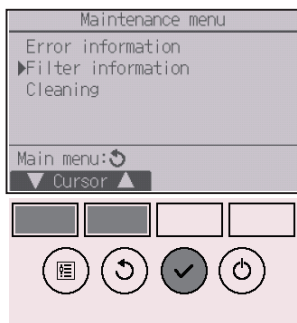

Vælg "Filter information" fra menuen Maintenance, og tryk på knappen **VÆLG**.

2



Tryk på **F4**-knappen for at nulstille filtersymbolet. I instruktionsvejledningen til indendørsenheden kan du se, hvordan du skal rengøre filteret.

3

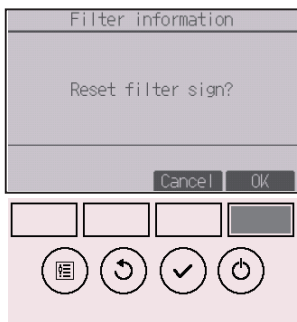

Vælg "OK" med [F4]-knappen.



Der vises en bekræftelseskærm.

Sådan navigerer du i skærmene

- Gå tilbage til hovedmenuen [MENU] knap
- Gå tilbage til den foregående skærm [TILBAGE] knap



Når  vises på statusdisplayet og hoveddisplayet i funktionen komplet, er systemet centralt styret, og filtersymbolet kan ikke nulstilles.

Hvis der er tilsluttet to eller flere indendørsenheder, kan tidspunktet for rengøring af filter for de enkelte enheder være forskelligt afhængig af filtertype.

Ikonet  vises, når filteret i hovedenheden skal rengøres.

Når filtersymbolet er nulstillet, nulstilles den samlede driftstid for alle enhederne.

Ikonet  vises efter en bestemt driftsperiode på baggrund af den antagelse, at indendørsenhederne er monteret i et lokale med normal luftkvalitet. Afhængig af luftkvalitet kan det være nødvendigt at rengøre filteret oftere.

Den samlede tid, hvor efter filteret skal rengøres, afhænger af den pågældende model.

Specifikationer

Specifikationer for kontrolenhed

	Specifikation
Produktstørrelse	Standard (PAR-CT01MAA(R)-SB/PAR-CT01MAA-S): 65 (B) × 120 (H) × 14,1 (D) mm (2 9/16 × 4 23/32 × 9/16 [tommer]) (ikke medregnet den del, der stikker ud)
	Premium (PAR-CT01MAA(R)-PB): 68 (B) × 120 (H) × 14,1 (D) mm (2 11/16 × 4 23/32 × 9/16 [tommer]) (ikke medregnet den del, der stikker ud)
Nettovægt	Standard (PAR-CT01MAA(R)-SB/PAR-CT01MAA-S): 0,09 kg (13/64 lb)
	Premium (PAR-CT01MAA(R)-PB): 0,10 kg (7/32 lb)
Nominel strømforsyningsspænding	12 VDC (fra indendørsenheder)
Strømforbrug	0,6 W
Brugermiljø	Temperatur 0 ~ 40°C (32 ~ 104°F) Fugtighed 25 ~ 90% relativ fugtighed (uden dugkondensation)
Materiale	Standard (PAR-CT01MAA(R)-SB/PAR-CT01MAA-S) Stativ: ABS
	Premium (PAR-CT01MAA(R)-PB) Stativ: ABS Sideplade: aluminium

Funktionsliste (fra 1. oktober 2017)

○ : Understøttet × : Ikke understøttet

	Funktion	CITY MULTI	Mr. SLIM	Krævet adgangskode
Effekt	Effekt TÆND/SLUK	○	○	-
Indstillinger	Funktionstilstand	○	○	-
	Indstillingen "Auto" (to indstillingspunkter)	○	○	-
	Forudindstillet temperatur	○	○	-
	Ventilatorhastighed	○	○	-
	Lamel	○	○	-
	Spjæld	○	○	-
	Ventilation	○	○	-
Betjeningsmenu	Høj effekt	×	○	-
	Manuel lamelvinkel	○	○	-
	3D i-See sensor	○	○	-
Timermenu	Timer (Tænd-/sluk-timer)	○	○	administrator
	Timer (Autosluk-timer)	○	○	administrator
	Ugetimer	○	○	administrator
	Driftsenhed lydløs funktion	○	○	administrator
	Natsænkning	○	○	administrator
Energibesparende menu	Begrænsning af temperaturområde	○	○	administrator
	Betjeningslåsfunktion	○	○	administrator
	Autoretur	○	○	administrator
	Tidsplan	×	○	administrator
Menu for standardindstilling	Ur	○	○	administrator
	Indstilling af format for urvisning	○	○	administrator
	Sommertid	○	○	administrator
	Hoveddisplay	○	○	administrator
	Ikonforklaring	○	○	administrator
	Lysstyrke	○	○	administrator
	Valg af sprog	○	○	administrator
	Design	○	○	administrator
	Kalibrering af touch-panel	○	○	administrator
	Rengøring af touch-panel	○	○	administrator
Adgangskode (administrator)	○	○	administrator	
Servicemenu	Initialisering af fjernkontrol	○	○	vedligeholdelse
	Oplysninger om fjernkontrolenheden	○	○	vedligeholdelse
	Testkørsel	○	○	vedligeholdelse
	Indlæsning af information om model	○	○	vedligeholdelse
	Indtast forhandlerinformation	○	○	vedligeholdelse
	Funktionsindstilling	○	○	vedligeholdelse
	Problemfri vedligeholdelse	×	○	vedligeholdelse
	Adgangskode (vedligeholdelse)	○	○	vedligeholdelse
Vedligeholdelsesmenu	Automatisk faldende panel	○	○	-
	Fejlinformation	○	○	-
	Filterinformation	○	○	-

* De understøttede funktioner varierer afhængig af enhedens model.

Specifikationer

Liste over funktioner, der kan/ikke kan benyttes sammen

	Høj effekt	Tænd-/sluk-timer	Autosluk-timer	Ugetimer	Driftsenhed lydløs funktion	Temperaturområde	Betjeningslås	Autoretur	Energi-besparende tidsplan	Natsænkning
Høj effekt		○	○	○	△ 1	○	△ 2	○	△ 1	○
Tænd-/sluk-timer	○		○	× 1	○	○	○	○	○	△ 3
Autosluk-timer	○	○		○	○	○	○	○	○	△ 4
Ugetimer	○	× 1	○		○	○	○	○	○	△ 5
Driftsenhed lydløs funktion	△ 1	○	○	○		○	○	○	○	○
Temperaturområde	○	○	○	○	○		○	× 2	○	△ 6
Betjeningslås	△ 2	○	○	○	○	○		○	○	○
Autoretur	○	○	○	○	○	× 2	○		○	△ 7
Energi-besparende tidsplan	△ 1	○	○	○	○	○	○	○		○
Natsænkning	○	△ 3	△ 4	△ 5	○	△ 6	○	△ 7	○	

○ : Kan benyttes sammen × : Kan ikke benyttes sammen △ : Begrænset

△ 1: Denne funktion aktiveres, når drift med høj effekt er afsluttet, da drift med høj effekt har højere prioritet.

△ 2: Denne funktion kan ikke vælges, hvis nogen af betjeningsfunktionerne er låst.

△ 3: Natsænkningfunktionen kan ikke benyttes, når enheden er i brug med indstilling af tænd-/sluk-timer.

△ 4: Autosluk-funktionen kan ikke benyttes til natsænkning.

△ 5: Natsænkningfunktionen kan ikke benyttes, når enheden er i brug med indstilling af ugetimer.

△ 6: Indstilling af temperaturområde kan ikke benyttes til natsænkning.

△ 7: Autoretur-funktionen kan ikke benyttes til natsænkning.

× 1: Indstilling af ugetimer fungerer ikke, fordi tænd-/sluk-timeren har højere prioritet.

× 2: Autoretur-funktionen kan ikke benyttes, fordi indstilling af temperaturområde har højere prioritet.

PAR-CT01MAA-PB(SB)

PAR-CT01MAR-PB(SB)

This product is designed and intended for use in the residential, commercial, and light-industrial environment.

The product at hand is based on the following EU regulations:

- RE Directive 2014/53/EU

PAR-CT01MAA-S

This product is designed and intended for use in the residential, commercial, and light-industrial environment.

The product at hand is based on the following EU regulations:

- Electromagnetic Compatibility Directive 2014/30/EU

MITSUBISHI ELECTRIC CORPORATION

HEAD OFFICE: TOKYO BLDG., 2-7-3, MARUNOUCHI, CHIYODA-KU, TOKYO 100-8310, JAPAN
MANUFACTURER: MITSUBISHI ELECTRIC CORPORATION Air-conditioning & Refrigeration Systems Works
5-66, Tebira 6 Chome, Wakayama-city, 640-8686, Japan

WT08560X01