

heatro

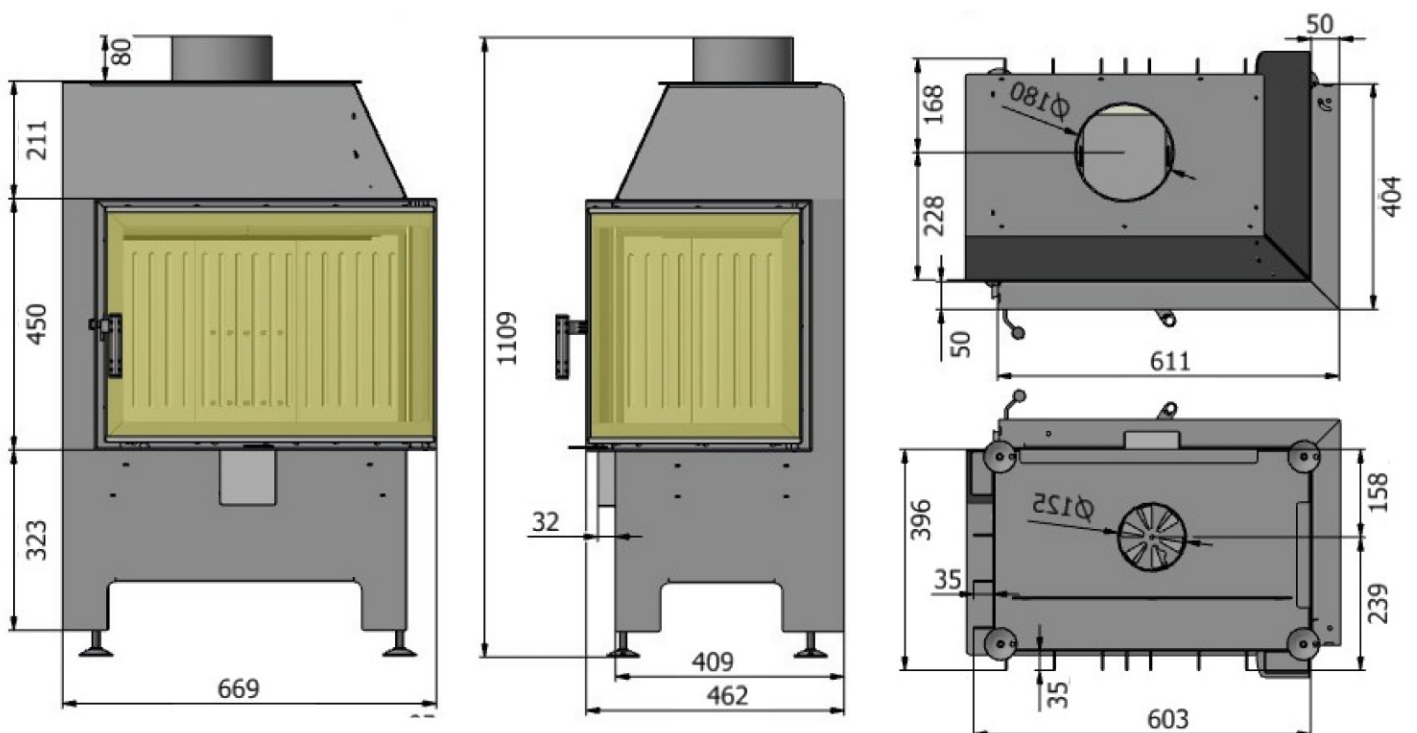

HEATRO 55P	
DANE TECHNICZNE	TECHNICAL DATA
Moc nominalna Nominal power	9 kW
Zakres mocy Power range	4-12 kW
Średnica dolotu powietrza Air intake diameter	125 mm
Średnica króćca wylotu spalin Flue exit pipe	180 mm
Sprawność Efficiency	80 %
Emisja CO (przy 13% O ₂) CO emission	0,1 %
Pył Dust	25 mg/m ³
Temperatura spalin Flue gas temperature	260 st.C
Wymagany ciąg kominowy Needed feed pressure	12 Pa
Maksymalna długość polan Max.length of logs	45 cm
Masa Weigth	118 kg
Gwarancja Guarantee	5 lat



podane wymiary są orientacyjne / all dimensions are approximate