

User manual

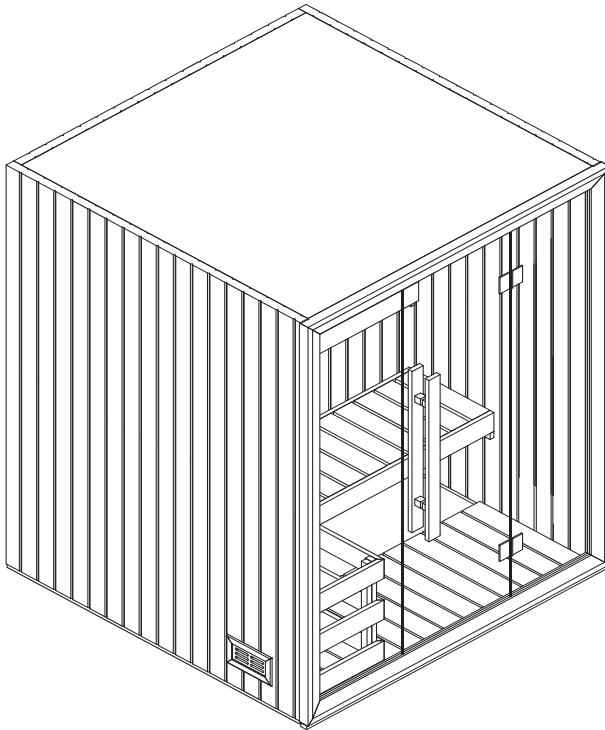

EN

DE

FR

IT

NL

CS

Element sauna

Onni sauna (1-053-080)

Table of Contents

1. About this instruction manual	3
2. Product description	4
2.1. Technical data	4
2.2. Floor plan	4
2.3. Scope of delivery	5
2.4. Parts list	6
3. Preparation for assembly	7
3.1. Tools required	7
3.2. Maintenance and cleaning	8
3.3. Disposal	8
4. Illustrations for assembling the cabin	9

1. About this instruction manual

Read these installation and operating instructions carefully and keep them within reach of the infrared cabin. This ensures that you can refer to information on safety and operation at any time.



These installation and operating instructions can also be found in the downloads section of our website: www.sentiotec.com/downloads.

Important note:

- Before you begin work, check the parts list to ensure that all the individual parts have been delivered. If you discover any missing parts, notify your dealer within 14 days of receiving the sauna cabin.
- The room that the sauna is installed in must be dry and ensure an appropriate amount of air circulation.
- The floor must be level and even, preferably a stone or tiled floor.
- A minimum room height of 230 cm is required for the cabin installation work.
- A distance of at least 5 cm from the wall must be maintained.
- The inside of the wooden parts used must not be handled with any impregnating material.
- You need an assistant for the installation.
- Wood is a natural product that can swell, shrink or warp, despite good storage. For this reason, some force may be necessary during the installation.

All screw fittings must be pre-drilled.

Attention!

The electrical connection may only be performed by a qualified electrician or similarly qualified person.

2. Product description

2.1. Technical data

Cabin material	Abachi
Cabin dimensions (L x W (depth) x H)	1600 x 1600 x 2000 mm
Recommended heating output	7,5 – 9 kW

2.2. Floor plan

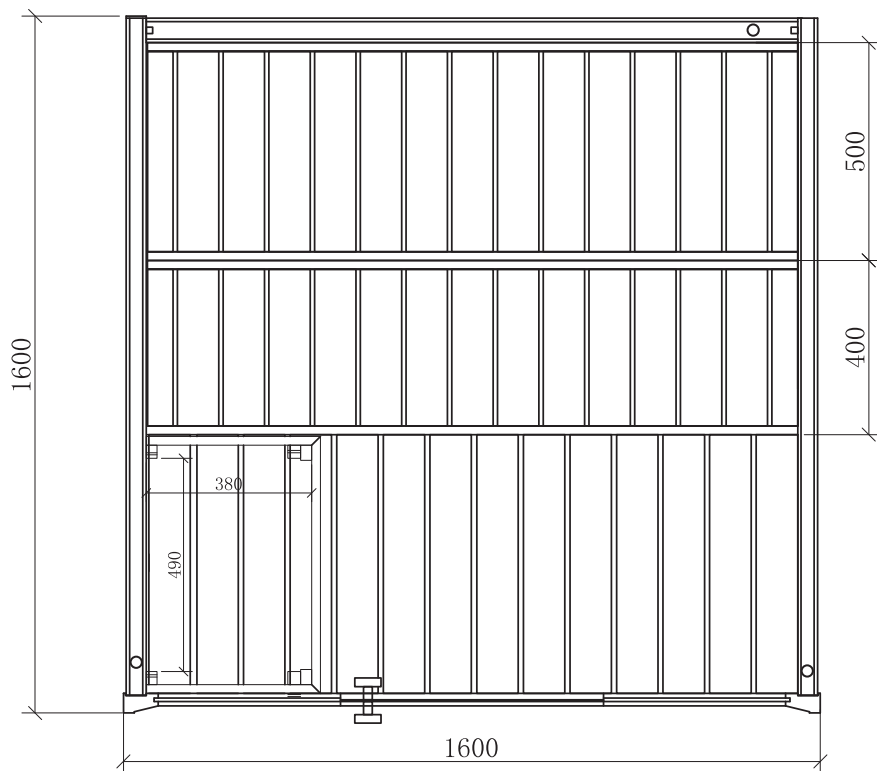

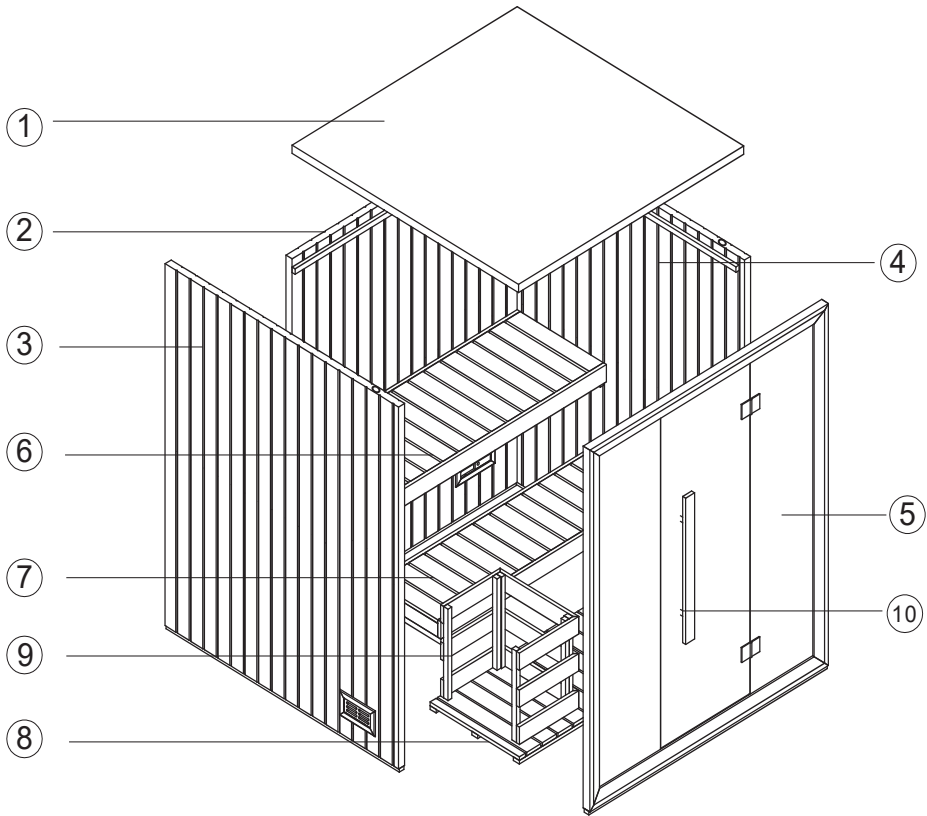

2.3. Scope of delivery



2.4. Parts list

No.	NAME	DIMENSIONS	PIECES
1	Roof element	1500 x 1492 x 46 mm	1
2	Rear wall	1507 x 2000 x 56 mm	1
3	Right side wall	1564 x 2000 x 46 mm	1
4	Left side wall	1564 x 2000 x 46 mm	1
5	Glass front	1600 x 2000 x 67 mm	1
6	Upper bench	1493 x 500 x 95 mm	1
7	Lower bench	1493 x 400 x 95 mm	1
8	Floor grid	1505 x 650 x 40 mm	1
9	Heater protection grille	590 x 400 x 500 mm	1
10	Door handle	800 x 60 x 50 mm	1
	Sauna lamp		1
	Lamp protection grill		1

Installation material

		
Φ 5 x 60	Φ 4 x 45	Φ 4 x 35
9 pcs.	26 pcs.	9 pcs.

3. Preparation for assembly

Before you begin work, check the parts list to ensure that all the individual parts have been delivered. If you discover any missing parts, notify your dealer within 14 days of receiving the sauna cabin. Button



You need an assistant for assembly.
We also advise you to pre-drill the holes for the screws.



Check the right angle:

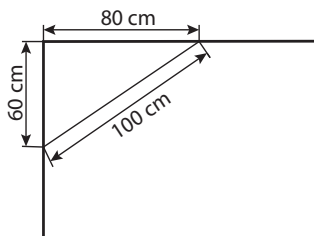

Handle glass with care: Special care must be taken with the edges of the glass – hardened glass can shatter into small pieces in the event of impact. Insert protective cushioning (e.g. cardboard box) under the edge of the glass.

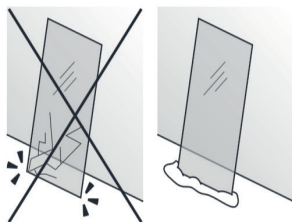

3.1. Tools required



Screwdriver



Tape measure



Drill



Twist drill



Utility knife



Spirit level



Pencil



Step ladder

3.2. Maintenance and cleaning

- The sauna should be cleaned with a damp cloth. Only use warm water – no cleaning products.
- We recommend heating the cabin once a month if the sauna is not used for a long time.

3.3. Disposal



Dispose of packaging materials in accordance with the applicable waste disposal regulations.



4. Illustrations for assembling the cabin

You will find the illustrations after the last language

Benutzerhandbuch

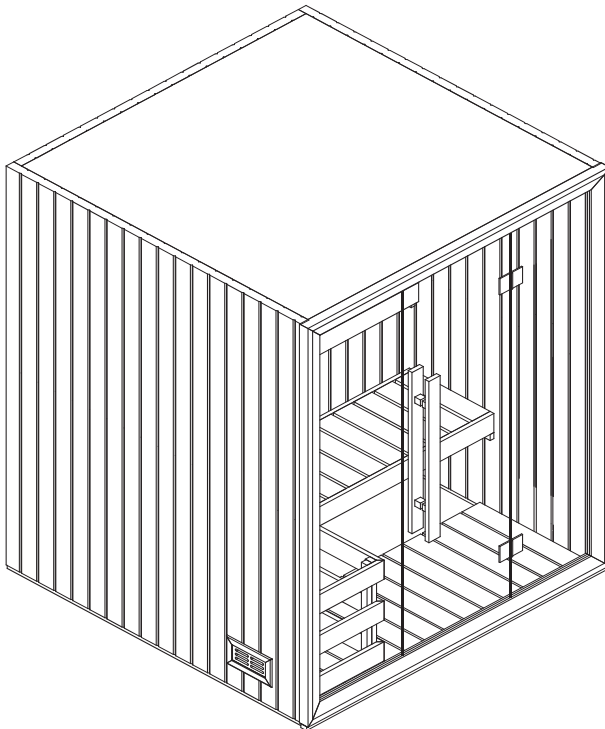

DE

Elementsauna

Onni Sauna (1-053-080)

Inhaltsverzeichnis

1. Zu dieser Anleitung	3
2. Produktbeschreibung	4
2.1. Technische Daten	4
2.2. Grundriss	4
2.3. Lieferumfang	5
2.4. Stückliste	6
3. Montagevorbereitung	7
3.1. Benötigtes Werkzeug	7
3.2. Wartung und Reinigung	8
3.3. Entsorgung	8
4. Montage Kabine Abbildungen	9

1. Zu dieser Anleitung

Lesen Sie diese Montage- und Gebrauchsanweisung gut durch und bewahren Sie sie in der Nähe der Infrarotkabine auf. So können Sie jederzeit Informationen zu Ihrer Sicherheit und zur Bedienung nachlesen.



Sie finden diese Montage- und Gebrauchsanweisung auch im Downloadbereich unserer Webseite auf www.sentiotec.com/downloads.

Wichtige Hinweise:

- Kontrollieren Sie, bevor Sie mit der Arbeit beginnen, anhand der Stückliste, ob alle Einzelteile auch tatsächlich mitgeliefert wurden. Sollten Einzelteile ausnahmsweise fehlen, benachrichtigen Sie spätestens 14 Tage nach Erhalt der Kabine Ihren Händler.
- Der Raum, in dem die Saunakabine montiert wird, muss trocken sein und eine entsprechende Luftzirkulation gewährleisten.
- Der Fußboden muss waagrecht und eben sein, bevorzugt Stein- oder Fliesenboden.
- Für die Montagearbeiten der Kabine wird eine Mindestraumhöhe von 230 cm benötigt.
- Es muss ein Wandabstand von mindestens 5 cm eingehalten werden.
- Die Innen zu verwendenden Holzteile dürfen nicht mit Imprägniermittel behandelt werden.
- Für die Montage benötigen Sie einen Helfer.
- Holz ist ein Naturprodukt, das trotz guter Lagerung aufquellen, schwinden oder sich verziehen kann. Aus diesem Grund kann es vorkommen, dass bei der Montage etwas Kraft aufgebracht werden muss.

Alle Verschraubungen müssen vorgebohrt werden.

Achtung!

Der Elektroanschluss darf nur durch eine Elektrofachkraft oder eine vergleichsweise qualifizierte Person ausgeführt werden.

2. Produktbeschreibung

2.1. Technische Daten

Kabinenmaterial	Abachi
Kabinenmaße (L x B (Tiefe) x H)	1600 x 1600 x 2000 mm
Empfohlene Ofenheizleistung	7,5 - 9 kW

2.2. Grundriss

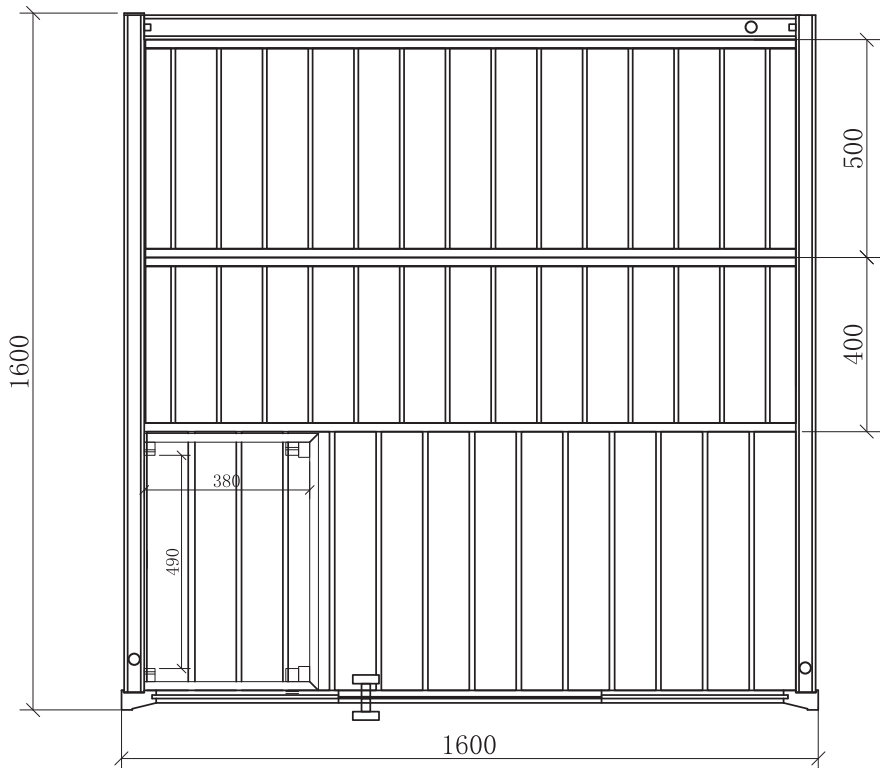

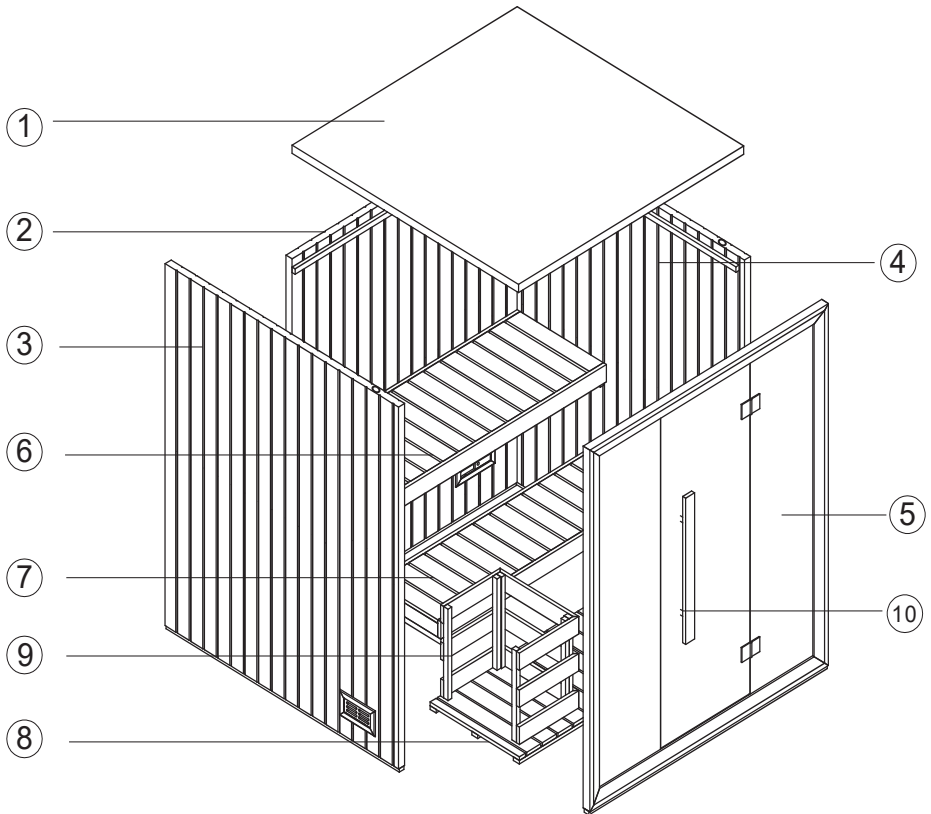

2.3. Lieferumfang



2.4. Stückliste

Nr.	NAME	ABMESSUNGEN	STÜCK
1	Dachelement	1500 x 1492 x 46 mm	1
2	Rückwand	1507 x 2000 x 56 mm	1
3	Rechte Seitenwand	1564 x 2000 x 46 mm	1
4	Linke Seitenwand	1564 x 2000 x 46 mm	1
5	Glas Front	1600 x 2000 x 67 mm	1
6	Obere Bank	1493 x 500 x 95 mm	2
7	Untere Bank	1493 x 400 x 95 mm	1
8	Bodenrost	1505 x 650 x 40 mm	1
9	Ofenschutzgitter	590 x 400 x 500 mm	1
10	Türgriff	800 x 60 x 50 mm	1
	Saunaleuchte		1
	Lampenschutzgitter		1

Montagematerial

		
Φ 5 x 60	Φ 4 x 45	Φ 4 x 35
9 Stk.	26 Stk.	9 Stk.

3. Montagevorbereitung

Kontrollieren Sie, bevor Sie mit der Arbeit beginnen, anhand der Stückliste, ob alle Einzelteile auch tatsächlich mitgeliefert wurden. Sollten Einzelteile ausnahmsweise fehlen, benachrichtigen Sie spätestens 14 Tage nach Erhalt der Kabine Ihren Händler. Taste



Für die Montage benötigen Sie einen Helfer!

Weiters empfehlen wir die Löcher für die Schrauben vorzubohren.



Überprüfung des rechten Winkel:

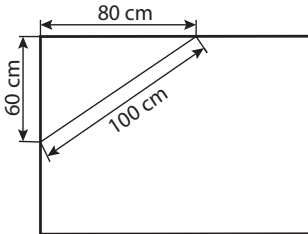

Vorsichtiger Umgang mit Glas: Besondere Vorsicht gilt den Glaskanten - Gehärtetes Glas kann bei Stößen in kleine Scherben zerspringen. Legen Sie ein Schutzpolster (z.Bsp.: Verpackungs-Karton) unter die Glaskante.

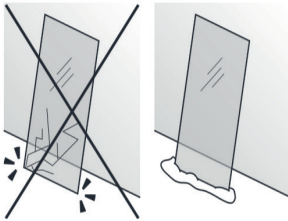

3.1. Benötigtes Werkzeug



Schraubendreher (Kit)



Bandmaß



Bohrmaschine



Spiralbohrer (Kit)



Cutter



Wasserwaage



Bleistift



Stehleiter

3.2. Wartung und Reinigung

- Die Sauna sollte mit einem feuchten Tuch gereinigt werden. Verwenden Sie nur warmes Wasser - keine Reinigungsmittel.
- Wird die Sauna längere Zeit nicht benutzt, empfehlen wir, die Kabine einmal im Monat aufzuheizen.

3.3. Entsorgung



Entsorgen Sie die Verpackungsmaterialien nach den gültigen Entsorgungsrichtlinien.



4. Montage Kabine Abbildungen

Die Abbildungen finden Sie nach der letzten Sprache.

Manuel d'utilisateur

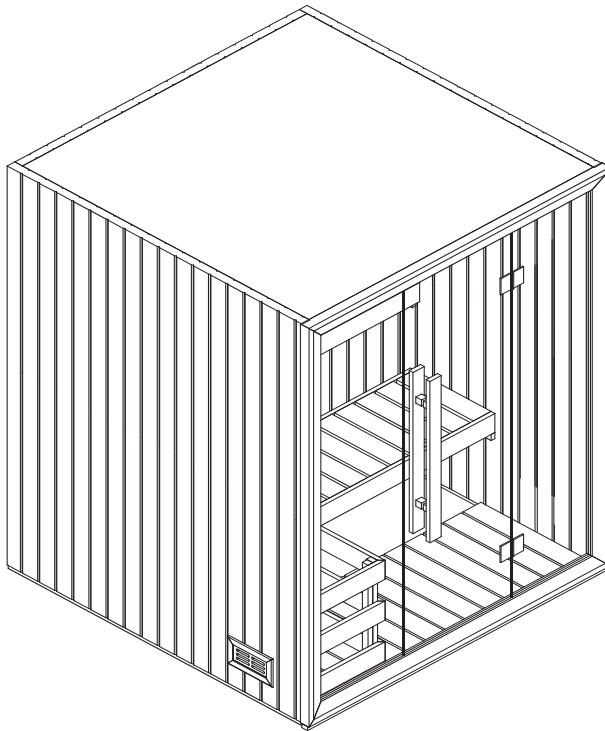

FR

Sauna à base d'éléments

Sauna Onni (1-053-080)

Table des matières

1. Concernant ces instructions	3
2. Description du produit	4
2.1. Caractéristiques techniques	4
2.2. Plan	4
2.3. Contenu de la livraison	5
2.4. Nomenclature	6
3. Préparation du montage	7
3.1. Outils requis	7
3.2. Entretien et nettoyage	8
3.3. Élimination	8
4. Illustrations de montage de la cabine	9

1. Concernant ces instructions

Lisez attentivement ces instructions de montage et ce mode d'emploi et conservez-les à proximité de la cabine infrarouge. Vous pouvez ainsi consulter à tout moment des informations concernant son utilisation et relatives à votre sécurité.



Ces instructions de montage et ce mode d'emploi sont également disponibles dans la zone de téléchargement de notre site Internet www.sentiotec.com/downloads.

Remarques importantes :

- Avant de commencer les travaux, vérifiez au moyen de la nomenclature si toutes les pièces ont bien été livrées. S'il devait s'avérer que des pièces manquent, informez votre revendeur dans les 14 jours suivant la réception de la cabine.
- La pièce dans laquelle la cabine de sauna va être montée doit être sèche et disposer d'une circulation suffisante de l'air.
- Le sol doit être horizontal et lisse, de préférence en pierre ou carrelage.
- Pour les travaux de montage de la cabine, la pièce doit faire au moins 230 cm de haut.
- Une distance d'au moins 5 cm avec le mur doit être respecté.
- Les pièces en bois prévues pour l'intérieur ne doivent pas être traitées avec un agent d'imprégnation.
- Une deuxième personne doit être disponible pour vous aider.
- Malgré un stockage correct, le bois est un produit naturel qui peut gonfler, se contracter ou se déformer. C'est pourquoi il peut arriver que vous ayez à appliquer de la force lors du montage.

Tous les raccords vissés doivent être préalésés.

Attention !

Seul un électricien spécialisé ou une personne ayant une qualification similaire est habilité à procéder au raccordement électrique.

2. Description du produit

2.1. Caractéristiques techniques

Matériau de la cabine	Abachi
Dimensions de la cabine (L x l (profondeur) x h)	1600 x 1600 x 2000 mm
Puissance de chauffage recommandée	7,5 - 9 kW

2.2. Plan

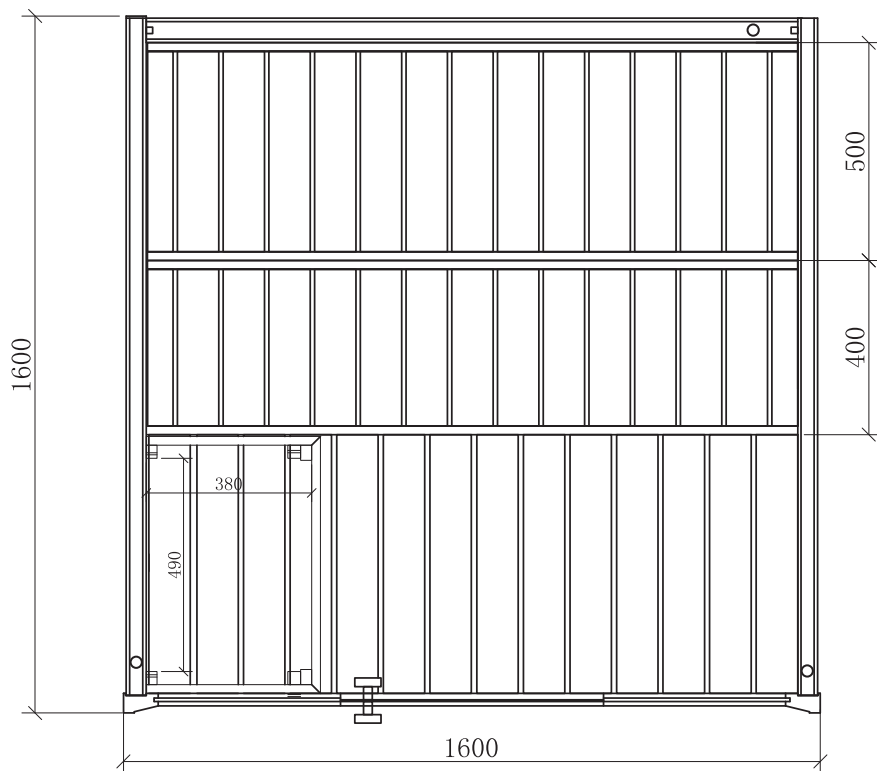

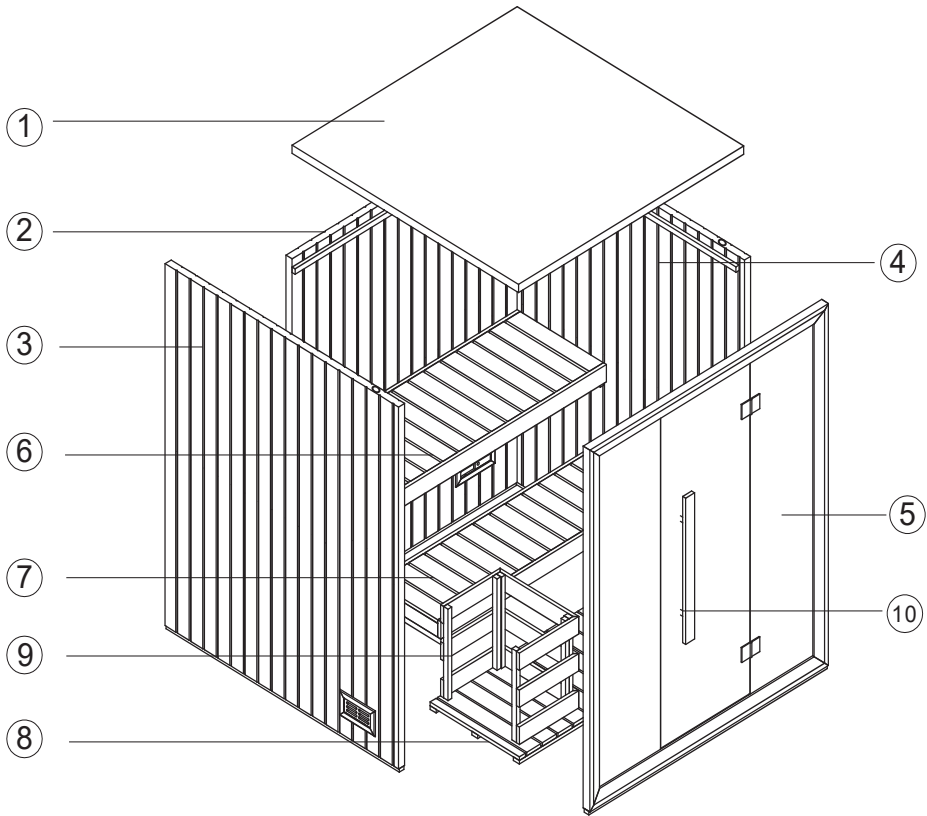

2.3. Contenu de la livraison



2.4. Nomenclature

N°	NOM	DIMENSIONS	PIÈCES
1	Élément de toit	1500 x 1492 x 46 mm	1
2	Paroi arrière	1507 x 2000 x 56 mm	1
3	Paroi latérale droite	1564 x 2000 x 46 mm	1
4	Paroi latérale gauche	1564 x 2000 x 46 mm	1
5	Façade vitrée	1600 x 2000 x 67 mm	1
6	Banc supérieur	1493 x 500 x 95 mm	2
7	Banc inférieur	1493 x 400 x 95 mm	1
8	Grille de plancher	1505 x 650 x 40 mm	1
9	Poignée de porte	590 x 400 x 500 mm	1
10	Grilles de protection de poêle	800 x 60 x 50 mm	1
	Lampe de sauna		1
	Cache pour lampe de sauna		1

Matériel de montage

		
Φ 5 x 60	Φ 4 x 45	Φ 4 x 35
9	26	9

3. Préparation du montage

Avant de commencer les travaux, vérifiez au moyen de la nomenclature si toutes les pièces ont bien été livrées. S'il devait s'avérer que des pièces manquent, informez votre revendeur dans les 14 jours suivant la réception de la cabine. Touche



Une deuxième personne doit être disponible pour vous aider.
En outre, nous recommandons de prépercer les trous pour les vis.



Contrôle de l'angle droit :

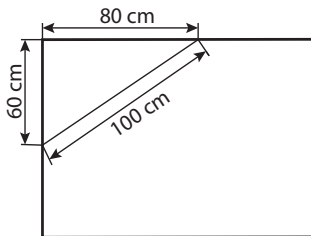

Manipulez le verre avec soin : Faire particulièrement attention avec les bords de la vitre ; en cas de choc, le verre trempé peut se briser en petits morceaux. Placez un rembourrage de protection (par ex., un emballage en carton) sous le bord de la vitre.

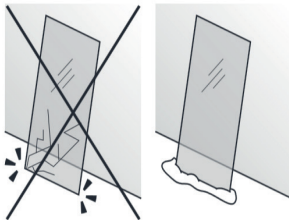

3.1. Outils requis



Tournevis



Mètre ruban



Perceuse



Foret hélicoïdal



Cutter



Niveau à bulle



Crayon à papier



Escabeau

3.2. Entretien et nettoyage

- Le sauna doit être nettoyé au moyen d'un chiffon humide. N'utilisez que de l'eau chaude, pas de détergent.
- Si le sauna n'est pas utilisé pendant une période prolongée, nous recommandons de chauffer la cabine une fois par mois.

3.3. Élimination



Éliminez les matériaux d'emballage conformément aux directives en vigueur relatives à l'élimination.



4. Illustrations de montage de la cabine

Les illustrations se trouvent après les dernières langues

Manuale d'uso

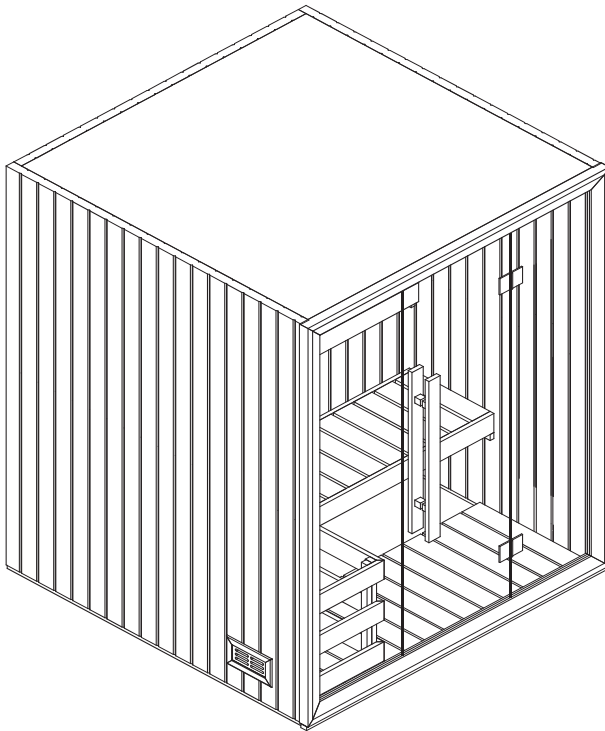

IT

Sauna a elementi

Onni Sauna (1-053-080)

Indice

1. Informazioni sul presente manuale	3
2. Descrizione del prodotto	4
2.1. Specifiche tecniche	4
2.2. Pianta	4
2.3. Dotazione	5
2.4. Elenco dei pezzi	6
3. Preparazione per il montaggio	7
3.1. Attrezzi necessari	7
3.2. Manutenzione e pulizia	8
3.3. Smaltimento	8
4. Figure di montaggio cabina	9

1. Informazioni sul presente manuale

Leggere attentamente le presenti istruzioni di montaggio e d'uso e conservarle vicino alla cabina a infrarossi. Così facendo è possibile controllare in ogni momento le informazioni sulla sicurezza e sull'utilizzo.



Le presenti istruzioni di montaggio e d'uso si trovano anche nell'area di download della nostra pagina web all'indirizzo:
www.sentiotec.com/downloads.

Indicazioni importanti:

- Prima di iniziare i lavori, controllare in base all'elenco dei pezzi se tutti i singoli componenti sono stati effettivamente forniti. Se eccezionalmente dovessero mancare dei singoli componenti, contattare il proprio fornitore entro 14 giorni dal ricevimento della cabina.
- L'ambiente in cui la cabina della sauna viene montata deve essere asciutto e garantire la circolazione dell'aria richiesta.
- Il pavimento deve essere orizzontale e uniforme, preferibilmente in pietra o piastrelle.
- Per i lavori di montaggio della cabina è necessaria un'altezza minima libera di 230 cm.
- Mantenere una distanza minima dalle pareti di 5 cm.
- I componenti in legno da utilizzare all'interno non devono essere trattati con impregnante.
- Per il montaggio è richiesto l'aiuto di una seconda persona.
- Il legno è un prodotto naturale che può gonfiarsi, ritirarsi o deformarsi anche se immagazzinato correttamente. In fase di montaggio potrebbe quindi essere necessario applicare una certa forza.

Tutte le connessioni a vite devono essere preforate.

Attenzione!

Il collegamento elettrico deve essere eseguito da elettricisti specializzati o da persone con una qualifica simile.

2. Descrizione del prodotto

2.1. Specifiche tecniche

Materiale della cabina	Obeche
Dimensioni cabina (L x L (profondità) x A)	1600 x 1600 x 2000 mm
Potenza di riscaldamento stufa consigliata	7,5 - 9 kW

2.2. Pianta

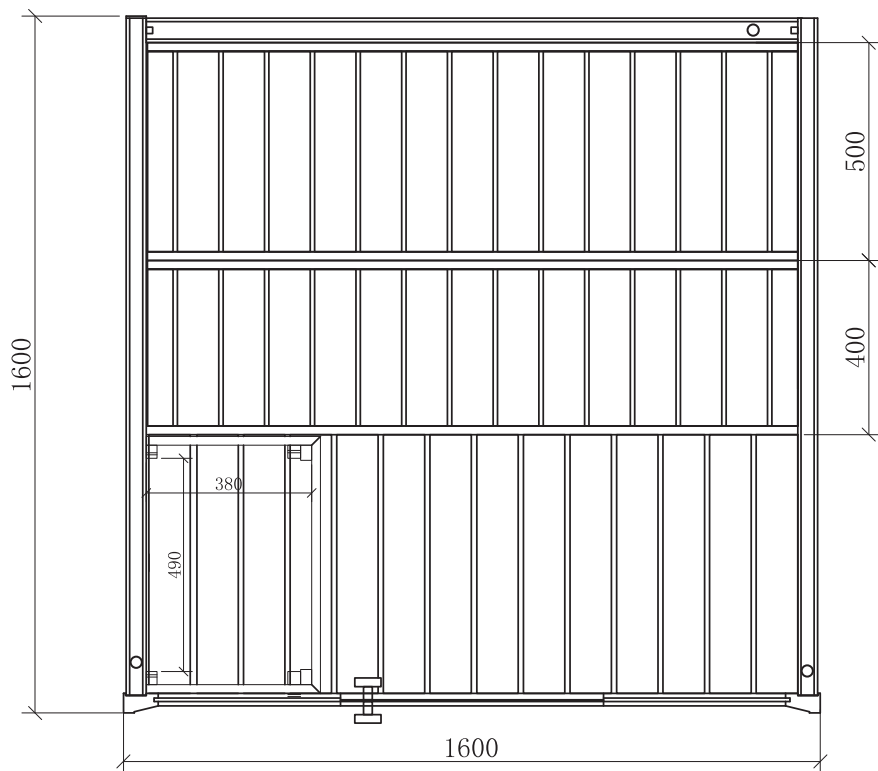

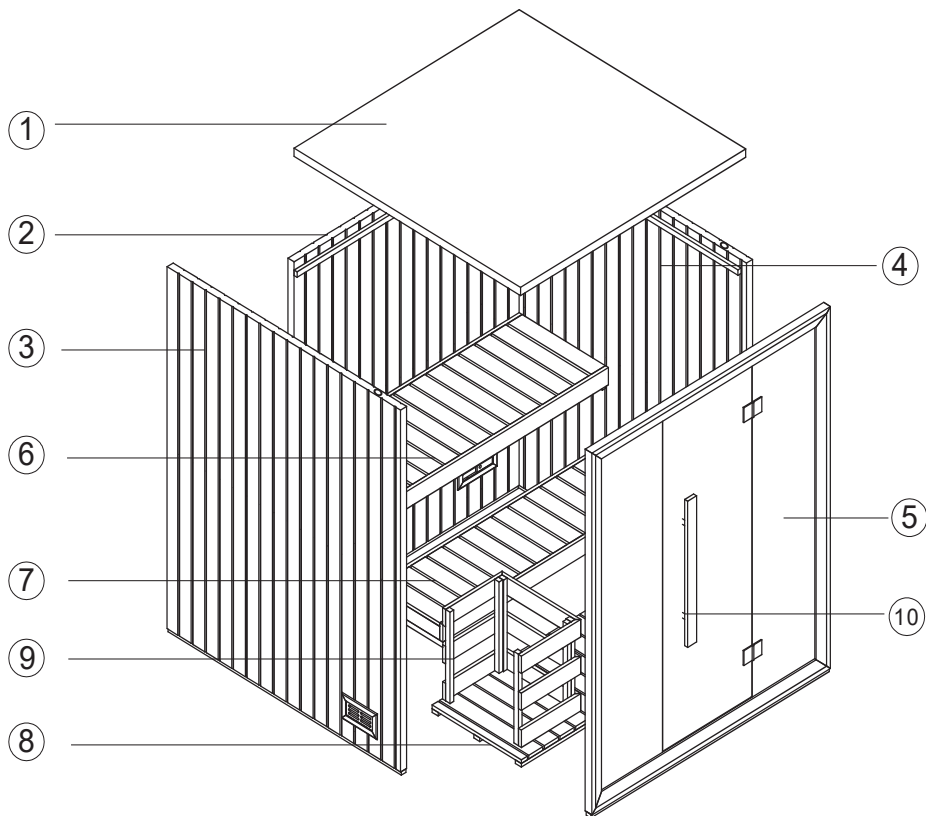

2.3. Dotazione



2.4. Elenco dei pezzi

N.	NOME	DIMENSIONI	PEZZI
1	Elemento tetto	1500 x 1492 x 46 mm	1
2	Pannello posteriore	1507 x 2000 x 56 mm	1
3	Pannello laterale destro	1564 x 2000 x 46 mm	1
4	Pannello laterale sinistro	1564 x 2000 x 46 mm	1
5	Vetro anteriore	1600 x 2000 x 67 mm	1
6	Panca superiore	1493 x 500 x 95 mm	2
7	Panca inferiore	1493 x 400 x 95 mm	1
8	Griglia di fondo	1505 x 650 x 40 mm	1
9	Griglia di protezione stufa	590 x 400 x 500 mm	1
10	Maniglia per porta	800 x 60 x 50 mm	1
	Lampada per sauna		1
	Copertura per luce sauna		1

Materiale di montaggio

		
Φ 5 x 60	Φ 4 x 45	Φ 4 x 35
9 pz.	26 pz.	9 pz.

3. Preparazione per il montaggio

Prima di iniziare i lavori, controllare in base all'elenco dei pezzi se tutti i singoli componenti sono stati effettivamente forniti. Se eccezionalmente dovessero mancare dei singoli componenti, contattare il proprio fornitore entro 14 giorni dal ricevimento della cabina. Tasto



Per il montaggio è richiesto l'aiuto di una seconda persona. Raccomandiamo anche di preforare i fori per le viti.



Verifica dell'ortogonalità:

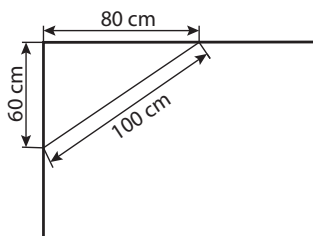

Maneggiare il vetro con cura: particolare attenzione deve essere prestata ai bordi del vetro - il vetro temprato può frantumarsi in piccoli pezzi in caso di impatto. Inserire un cuscino di protezione (ad es: scatola di cartone) sotto il bordo del vetro.

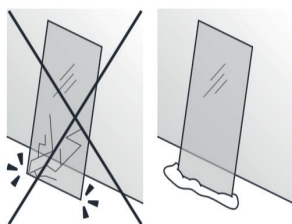

3.1. Attrezzi necessari



Cacciavite



Metro a nastro



Trapano



Trapano a punta elicoidale



Taglierina



Livella a bolla



Matita



Scala a libro

3.2. Manutenzione e pulizia

- La sauna deve essere pulita con un panno umido. Utilizzare solo acqua calda senza detersivi.
- Se la sauna non viene utilizzata per un tempo prolungato, si consiglia di riscaldare la cabina una volta al mese.

3.3. Smaltimento



Smaltire i materiali dell'imballaggio conformemente alle normative sullo smaltimento vigenti.



4. Figure di montaggio cabina

Le figure sono riportate dopo l'ultima lingua

Gebruikershandboek

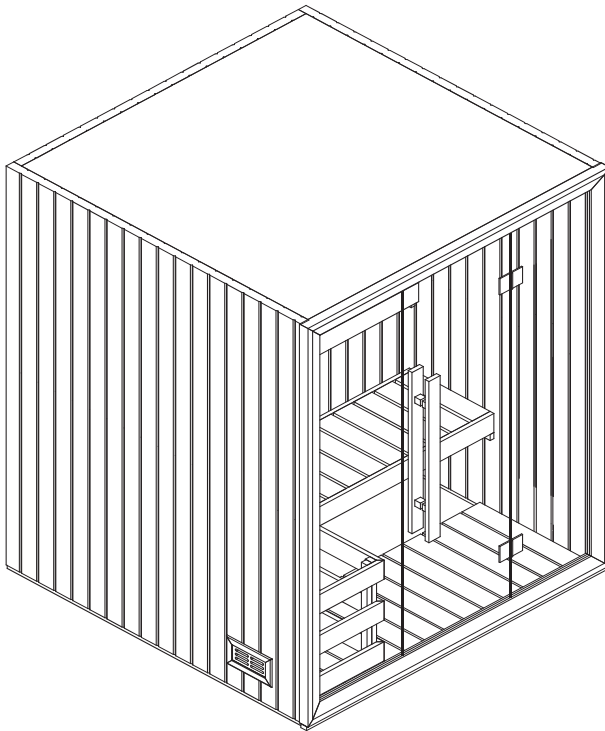

NL

Elementsauna

Onni Sauna (1-053-080)

Inhoudsopgave

1. Over deze handleiding	3
2. Productbeschrijving	4
2.1. Technische gegevens	4
2.2. Plattegrond	4
2.3. Leveromvang	5
2.4. Stuklijst	6
3. Montagevoorbereiding	7
3.1. Vereist gereedschap	7
3.2. Onderhoud en reiniging	8
3.3. Afvoer	8
4. Montage cabine afbeeldingen	8

1. Over deze handleiding

Lees deze montage- en gebruiksaanwijzing goed door en bewaar deze in de buurt van de infraroodcabine. Zo kunt u te allen tijde informatie over uw veiligheid en de bediening nalezen.



U vindt deze montage- en gebruiksaanwijzing ook op onze website:
www.sentiotec.com/downloads.

Belangrijke aanwijzingen:

- Controleer alvorens met de montage te beginnen aan de hand van de stuklijst of alle afzonderlijke delen werden geleverd. Als er delen ontbreken, neem dan uiterlijk 14 dagen na ontvangst van de cabine contact op met uw handelaar.
- De ruimte waarin de saunacabine wordt gemonteerd, moet droog zijn en er moet een goede luchtcirculatie gegarandeerd zijn.
- De vloer moet waterpas en effen zijn, bij voorkeur een stenen vloer of tegelvloer.
- Voor de montagewerkzaamheden van de cabine is een minimale ruimtehoogte van 230 cm vereist.
- De afstand tot de wand moet minstens 5 cm bedragen.
- De houten onderdelen die binnenin worden gebruikt, mogen niet worden behandeld met impregneermiddel.
- De montage moet door twee personen worden uitgevoerd.
- Hout is een natuurlijk product dat ondanks correcte opslag kan uitzetten, krimpen of krom trekken. Daardoor kan het zijn dat bij de montage kracht moet worden toegepast.

Alle schroefverbindingen moeten worden voorgeboord.

Let op!

De elektrische aansluiting mag alleen worden uitgevoerd door een elektricien of een vergelijkbaar gekwalificeerd persoon.

2. Productbeschrijving

2.1. Technische gegevens

Cabinemateriaal	Abachi
Afmetingen cabine (l x b (diepte) x h)	1600 x 1600 x 2000 mm
Aanbevolen kachelermogen	7,5 - 9 kW

2.2. Plattegrond

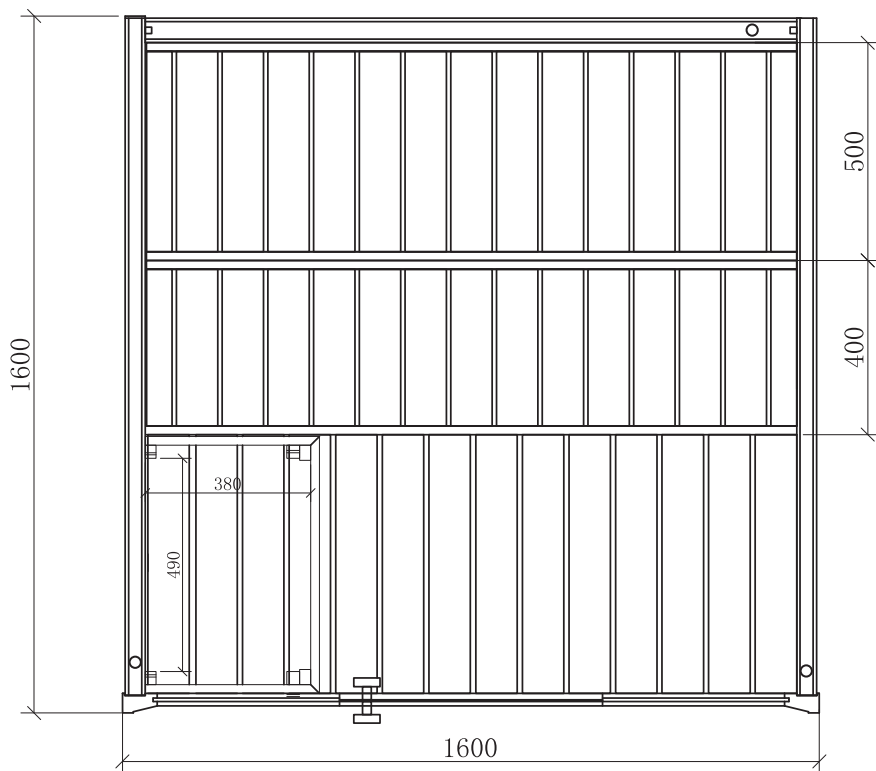

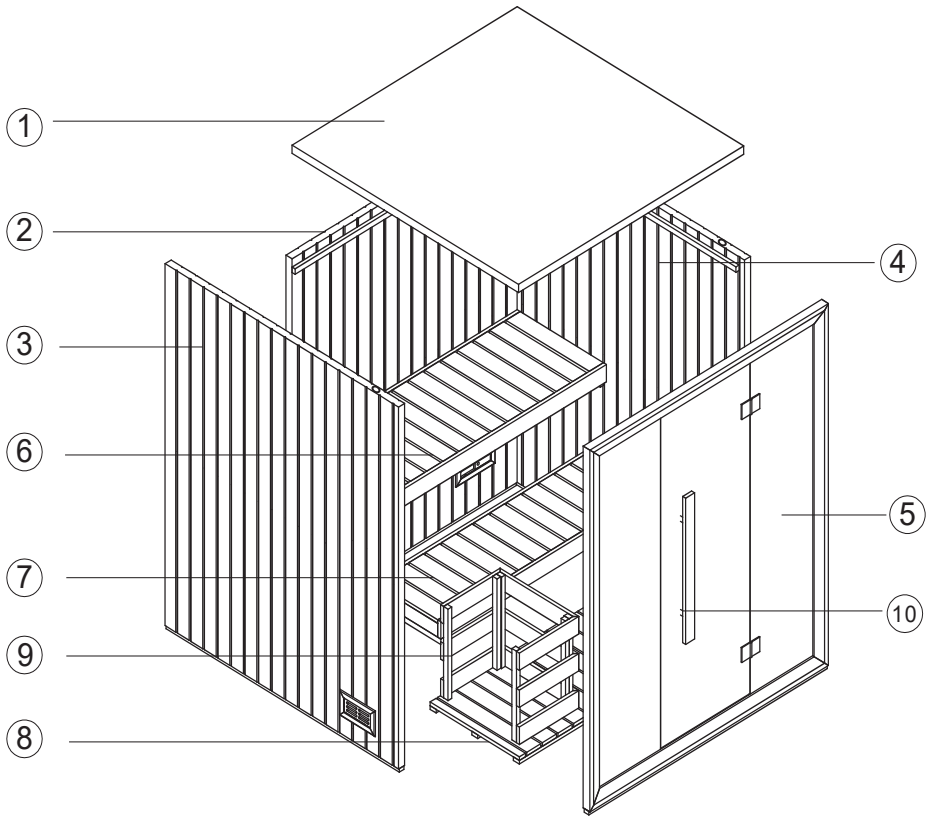

2.3. Leveromvang



2.4. Stuklijst

Nr.	NAAM	AFMETINGEN	STUKS
1	Dakelement	1500 x 1492 x 46 mm	1
2	Achterwand	1507 x 2000 x 56 mm	1
3	Rechter zijwand	1564 x 2000 x 46 mm	1
4	Linker zijwand	1564 x 2000 x 46 mm	1
5	Glazen front	1600 x 2000 x 67 mm	1
6	Bovenste bank	1493 x 500 x 95 mm	2
7	Onderste bank	1493 x 400 x 95 mm	1
8	Vloerrooster	1505 x 650 x 40 mm	1
9	Kachelbeschermingsrooster	590 x 400 x 500 mm	1
10	Deurgreep	800 x 60 x 50 mm	1
	Saunalicht		1
	Lampbeschermingsmateriaal		1

Montagemateriaal

		
Φ 5 x 60	Φ 4 x 45	Φ 4 x 35
9 Stk.	26 Stk.	9 Stk.

3. Montagevoorbereiding

Controleer alvorens met de montage te beginnen aan de hand van de stuklijst of alle afzonderlijke delen werden geleverd. Als er delen ontbreken, neem dan uiterlijk 14 dagen na ontvangst van de cabine contact op met uw handelaar.



Voor de montage heeft u een tweede persoon nodig!
Bovendien raden we aan om de gaten voor de schroeven voor te boren.



Controle van de rechte hoek:

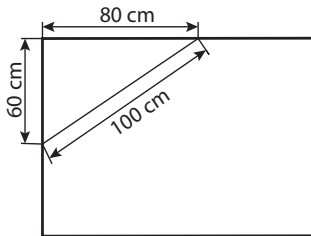

Voorzichtige omgang met glas: met de glazen randen dient u bijzonder voorzichtig om te gaan – gehard glas kan door stoten in kleine scherven versplinteren. Leg een beschermende ondergrond (bijv.: verpakkingskarton) onder de glazen rand.

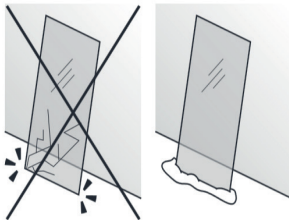

3.1. Vereist gereedschap



Schroevendraaier (kit)



Bandmaat



Boormachine



Spiraalboor (kit)



Cutter



Waterpas



Potlood



Staande ladder

3.2. Onderhoud en reiniging

- De sauna moet met een vochtige doek worden gereinigd. Gebruik alleen warm water, geen reinigingsmiddel.
- Als de sauna voor langere tijd niet wordt gebruikt, adviseren wij de cabine een keer per maand te verwarmen.

3.3. Afvoer



Voer het verpakkingsmateriaal af volgens de geldende afvoerrichtlijnen.



4. Montage cabine afbeeldingen

De afbeeldingen vindt u na de laatste taal.

Uživatelská příručka

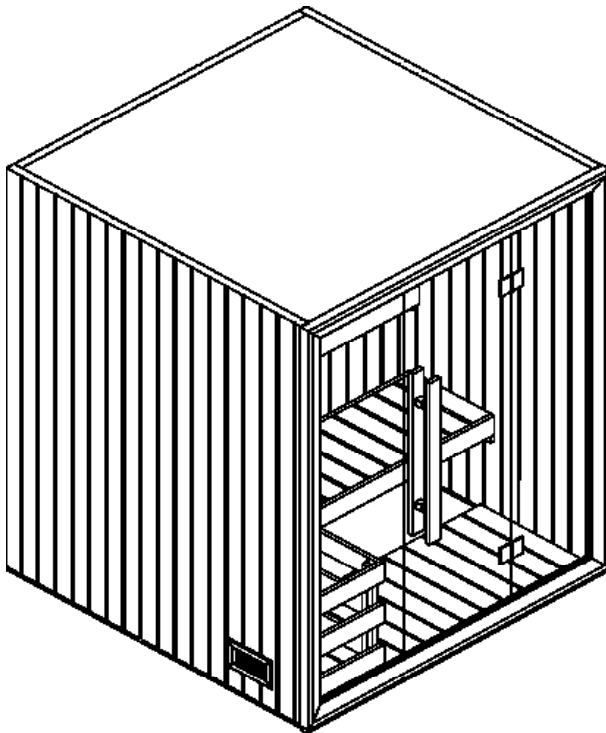

CS

Modulární sauna

Onni Sauna (1-053-080)

Obsah

1. O tomto návodu	3
2. Popis výrobku	4
2.1. Technické údaje	4
2.2. Půdorys	4
2.3. Rozsah dodávky	5
2.4. Seznam součástí	6
3. Příprava na montáž	7
3.1. Potřebné nářadí	7
3.2. Údržba a čištění	8
3.3. Likvidace	8
4. Obrázky montáže kabiny	8

1. O tomto návodu

Tento návod k montáži a použití si důkladně pročtěte a uložte jej v blízkosti infrakabiny. Tak si můžete vždy dodatečně přečíst informace o bezpečnosti a obsluze.



Tento návod k montáži a použití naleznete také v sekci ke stažení na našem webu na adrese www.sentiotec.com/downloads.

Důležité pokyny:

- než začnete pracovat, zkontrolujte podle kusovníku, zda byly všechny díly skutečně dodány. Pokud jednotlivé díly výjimečně chybí, informujte svého prodejce nejpozději do 14 dnů po obdržení kabiny.
- Místnost, ve které je saunová kabina umístěna, musí být suchá a musí zajistit odpovídající cirkulaci vzduchu.
- Podlaha musí být vodorovná a rovná, nejlépe kamenná podlaha nebo dlažba.
- Pro montážní práce v kabině je vyžadována minimální výška místnosti 230 cm.
- Je nutné dodržet odstup od stěny minimálně 5 cm.
- Dřevěné části, které se mají používat uvnitř, nesmí být ošetřeny impregnačním činidlem.
- Pro montáž potřebujete pomocníka.
- Dřevo je přírodní produkt, který může navzdory dobrému skladování bobtnat, smršťovat se nebo deformovat. Z tohoto důvodu se může stát, že při montáži musí být použita určitá síla.

Všechny šroubové spoje musí být předvrtány.

Pozor!

Elektrické připojení smí provádět pouze kvalifikovaný elektrikář nebo jiná, srovnatelným způsobem kvalifikovaná osoba.

2. Popis výrobku

2.1. Technické údaje

Materiál kabiny	Africká vrba (abachi)
Rozměry kabiny (D x Š (hloubka) x V)	1600 x 1600 x 2000 mm
Doporučený topný výkon kamen	7,5–9 kW

2.2. Půdorys

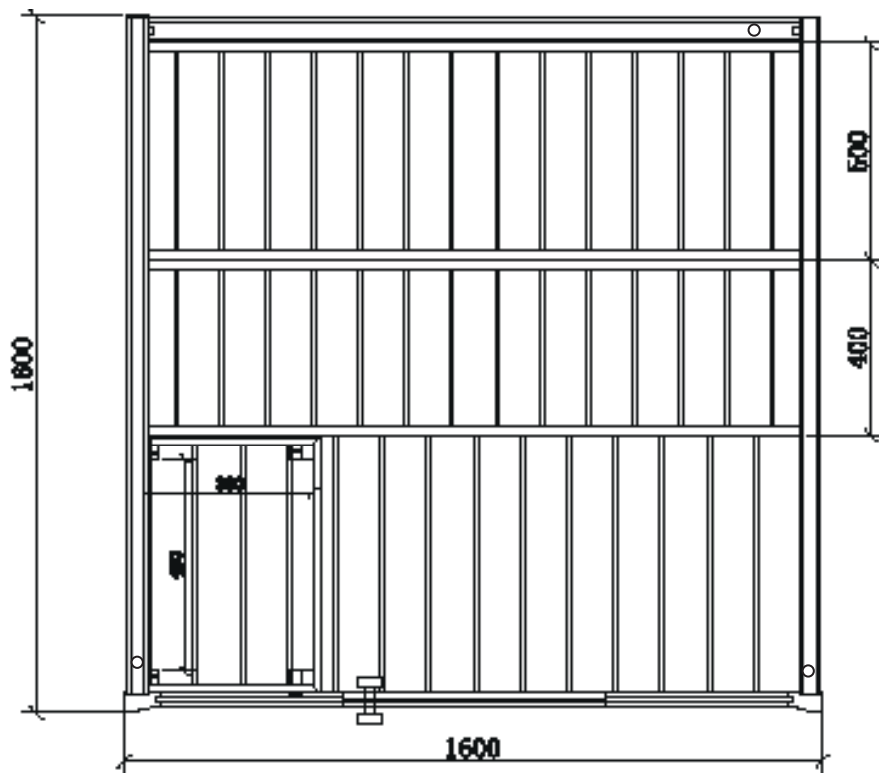

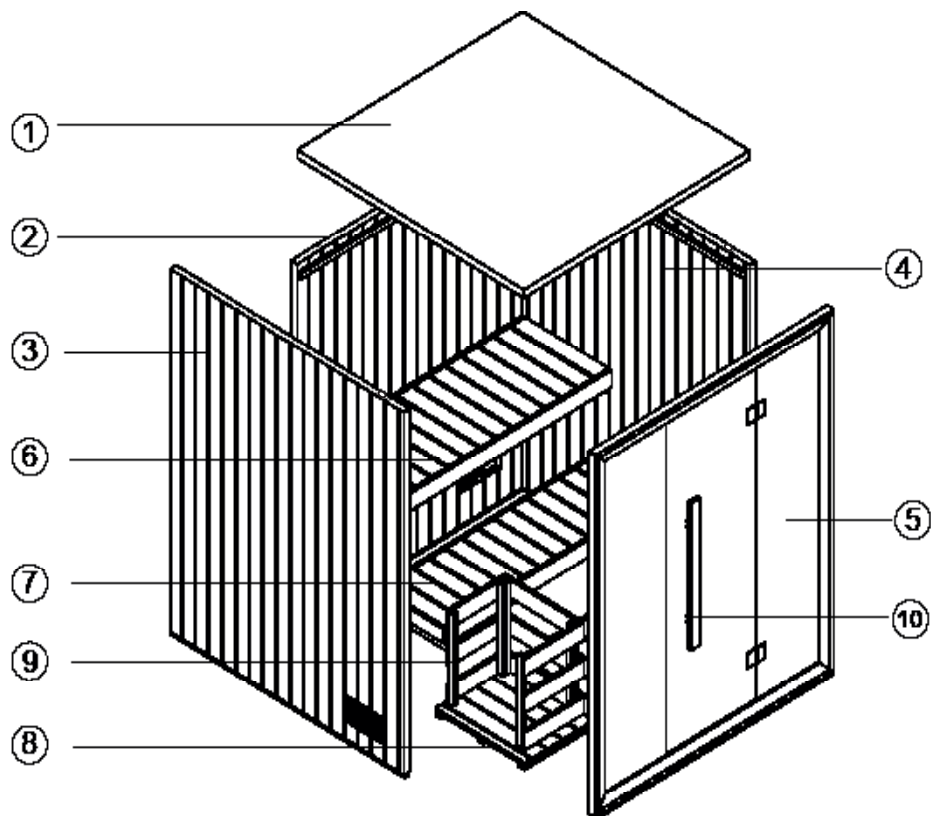

2.3. Rozsah dodávky



2.4. Seznam součástí

č.	NÁZEV	ROZMĚRY	POČET
1	Střešní prvek	1500 x 1492 x 46 mm	1
2	Zadní stěna	1507 x 2000 x 56 mm	1
3	Pravá boční stěna	1564 x 2000 x 46 mm	1
4	Levá boční stěna	1564 x 2000 x 46 mm	1
5	Přední sklo	1600 x 2000 x 67 mm	1
6	Horní lavice	1493 x 500 x 95 mm	2
7	Dolní lavice	1493 x 400 x 95 mm	1
8	Podlahový rošt	1505 x 650 x 40 mm	1
9	Ochranná mřížka kamen	590 x 400 x 500 mm	1
10	Rukojeť dveří	800 x 60 x 50 mm	1
	Saunové světlo		1
	Ochranná mřížka lampy		1

Montážní materiál

		
Φ 5 x 60	Φ 4 x 45	Φ 4 x 35
9 ks	26 ks	9 ks

3. Příprava na montáž

než začnete pracovat, zkontrolujte podle kusovníku, zda byly všechny díly skutečně dodány. Pokud jednotlivé díly výjimečně chybí, informujte svého prodejce nejpozději do 14 dnů po obdržení kabiny. Tlačítko



Pro montáž potřebujete pomocníka!
Dále doporučujeme předvrtat otvory pro šrouby.



Kontrola pravého úhlu:

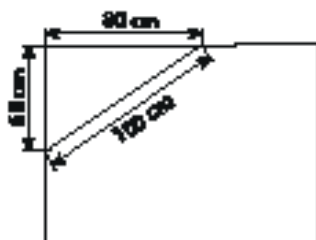

Opatrné zacházení se sklem: Obzvláště opatrní buďte, pokud jde o hrany skla - tvrzené sklo se může v důsledku nárazu roztříštit na malé kousky. Podložte pod hrany skla ochrannou vycpávku (např.: kartonový obal).

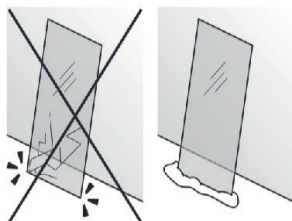

CS

3.1. Potřebné nářadí



Šroubováky
(sada)



Šroubovitě
vrtáky (sada)



vodováha



Měřicí pásmo



Nůž na řezání
(zalamovací)



Tužka



Vrtačka



Schůdky

3.2. Údržba a čištění

- Sauna by měla být čištěna vlhkým hadříkem. Používejte pouze teplou vodu – žádné čisticí prostředky.
- Pokud se sauna delší dobu nepoužívá, doporučujeme ji jednou měsíčně vyhřát.

3.3. Likvidace



Obalové materiály zlikvidujte podle směrnic platných pro likvidaci.



4. Obrázky montáže kabiny

Obrázky naleznete za poslední jazykovou verzí.

4.

1

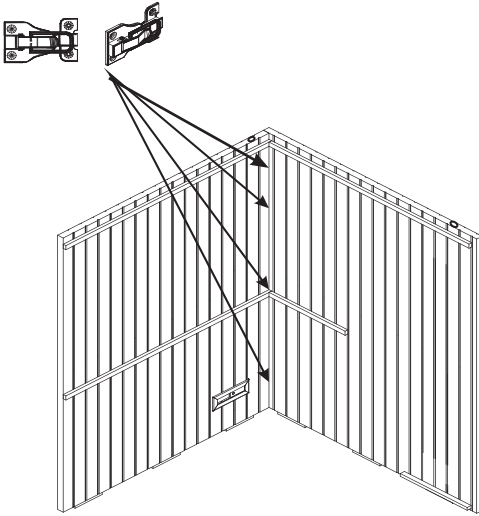

2

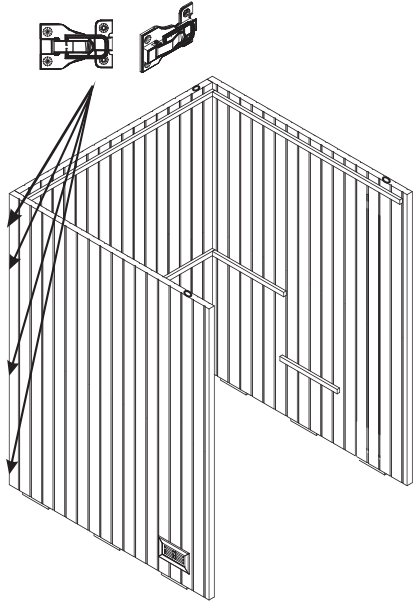

3

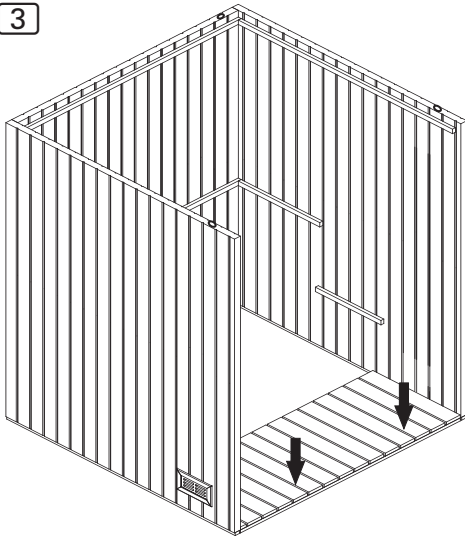

4

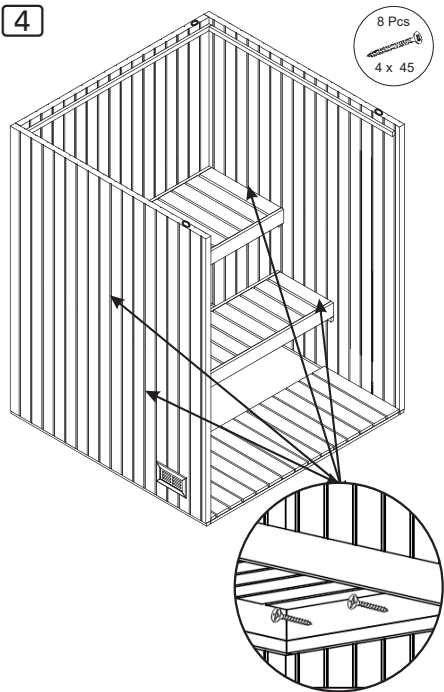

5

9 Pcs
4 x 35

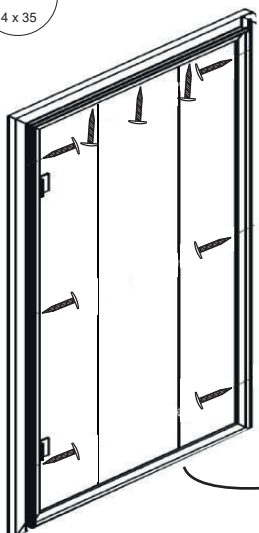

6

2 Pcs
6 x 60

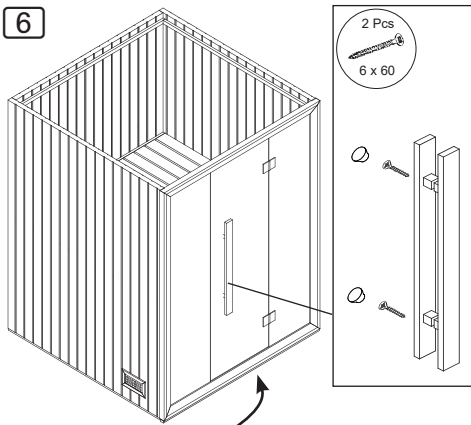

7

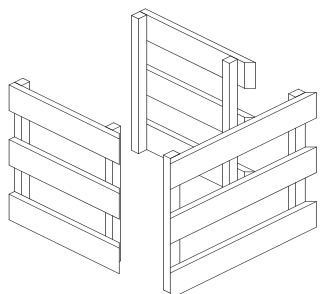

6 Pcs
4 x 45

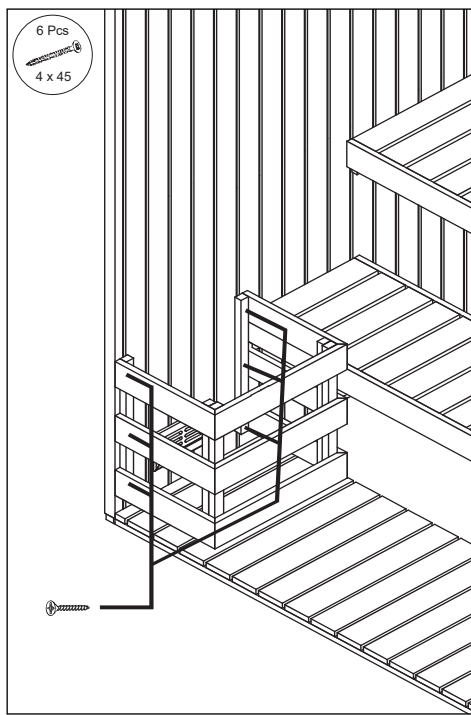
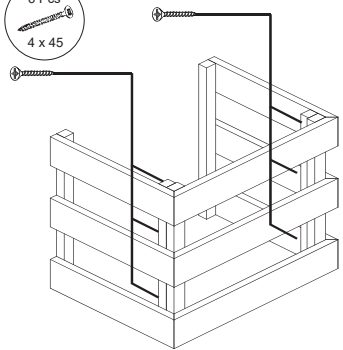

8

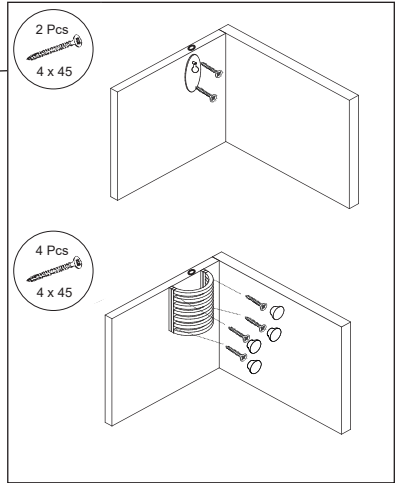
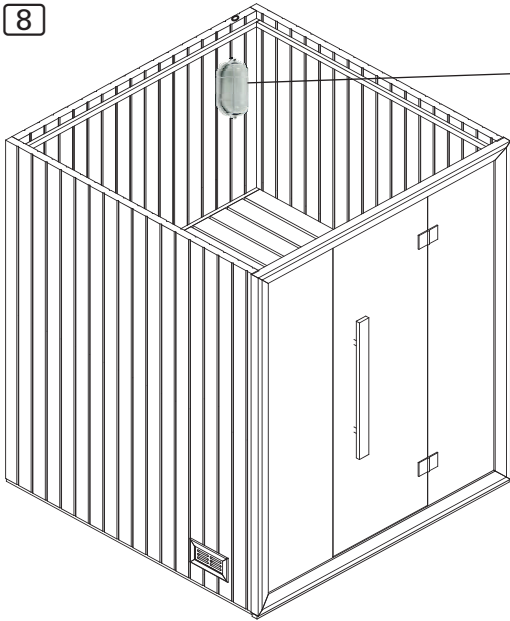

2 Pcs
4 x 45

4 Pcs
4 x 45

9

9 Pcs
5 x 60

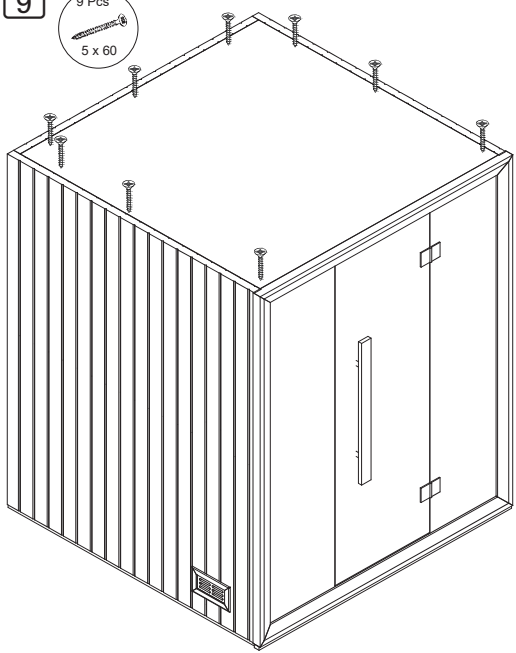



sentiotec GmbH | Division of Harvia Group | Wartenburger Straße 31, A-4840 Vöcklabruck
T +43 (0) 7672/22 900-50 | F -80 | info@sentiotec.com | www.sentiotec.com