

REV.	Description	REV.	Description
0.0	首次发布		
	郑安琪 2023/08/01		

品名	说明书 BMS Parallel Box-II G2 英文版 SolaX			 浙江艾罗网络能源技术股份有限公司 SolaX Power Network Technology (Zhejiang) Co., Ltd.
料号	320101064100			
单位	mm	页次		

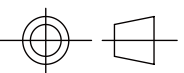

- 技术要求:
- 1.封面封底157g铜版纸覆哑膜彩打，内部纸80g双胶纸黑白印刷，正反打印
  - 2.装订方式:页码大于60需用胶装
  - 3.未注尺寸公差按 +/- 1.5mm
  - 4.图面、字体印刷清晰、无毛边、不起边、油墨不脱落
  - 5.字体颜色为PANTONE Black C，无边框，底色为白色
  - 6.符合RoHS要求

品名	说明书 BMS Parallel Box-II G2 英文版 SolaX		设计	郑安琪	2023/08/01
			审核	赵焱	2023/08/01
材料	NA		核准	施鑫淼	2023/08/01
料号	320101064100		 浙江艾罗网络能源技术股份有限公司		
单位	mm	页次			

# Triple Power BMS Parallel Box-II G2 User Manual



## SolaX Power Network Technology (Zhejiang) Co., Ltd.

Add.: No. 288, Shizhu Road, Tonglu Economic Development Zone, Tonglu City,  
Zhejiang Province, 310000 P.R. CHINA  
Tel.: +86 (0) 571-5626 0011  
E-mail: info@solaxpower.com

Copyright © SolaX Power Technology (Zhejiang) Co., Ltd. All rights reserved.  
No part of this document may be reproduced or transmitted in any form or by any  
means without prior written consent of SolaX Power Technology (Zhejiang) Co., Ltd.  
(hereinafter referred to as SolaX). SolaX reserves the right of final interpretation.

## **CHANGE HISTORY**

Changes between document versions are cumulative. The latest version contains all updates made in previous versions.

### **Version 00 (July. 20, 2023)**

Initial release

# Contents

1	NOTE ON THIS MANUAL .....	1	6	TROUBLESHOOTING.....	24
	1.1 SCOPE OF VALIDITY.....	1	7	DECOMMISSIONING .....	26
	1.2 TARGET GROUP.....	1		7.1 DISMANTLING THE BOX .....	26
	1.3 SYMBOLS USED.....	1		7.2 PACKAGING .....	26
2	SAFETY .....	2	8	MAINTENANCE.....	27
	2.1 APPROPRIATE USAGE .....	2	9	WARRANTY .....	28
	2.2 IMPORTANT SAFETY INSTRUCTIONS.....	3	*	WARRANTY REGISTRATION FORM	
	2.3 QUALIFIED INSTALLER.....	4			
3	PRODUCTION INTRODUCTION.....	6			
	3.1 PRODUCTION OVERVIEW .....	6			
	3.1.1 DIMENSIONS.....	6			
	3.1.2 APPEARANCE .....	7			
	3.2 BASIC FEATURES .....	8			
	3.2.1 FEATURES .....	8			
	3.2.2 CERTIFICATIONS.....	8			
	3.3 TECHNICAL DATA .....	8			
4	INSTALLATION.....	10			
	4.1 INSTALLATION PREREQUISITES.....	10			
	4.2 SAFETY GEAR .....	10			
	4.3 TOOLS .....	11			
	4.4 INSTALLATION.....	11			
	4.4.1 CHECK FOR TRANSPORT DAMAGE .....	11			
	4.4.2 UNPACKING.....	11			
	4.4.3 ACCESSORIES .....	12			
	4.4.4 MOUNTING STEPS.....	12			
	4.5 OVERALL INSTALLATION .....	14			
	4.6 CABLE CONNECTION.....	16			
	4.6.1 CONNECTING CABLES TO INVERTER.....	16			
	4.6.2 CONNECTING BATTERY MODULES.....	18			
	4.6.3 CONNECTING COMMUNICATION CABLES.....	20			
5	COMMISSIONING .....	21			
	5.1 CONFIGURING BATTERY SYSTEM.....	21			
	5.2 COMMISSIONING .....	22			
	5.3 STATUS INDICATORS .....	23			

# 1 Note on this Manual

## 1.1 Scope of Validity

This manual is an integral part of the Parallel Box Series.

It describes the assembly, installation, commissioning, maintenance and failure of the product. Please read carefully prior to operation.

Model: BMS Parallel Box-II G2

### NOTE!





The BMS Parallel Box-II G2 can be used with T-BAT-SYS-HV-5.8 or T-BAT-SYS-HV-3.0. Please refer to section 4 "Installation" from page 10 to page 20 for details.

## 1.2 Target Group

This manual is for qualified electricians. The tasks described in this manual should only be performed by qualified electricians.

## 1.3 Symbols Used

The following types of safety instructions appear in this document are described below:

	<b>DANGER!</b> "DANGER" indicates a hazardous situation which, if not avoided, will result in serious injury or death.
	<b>WARNING!</b> "WARNING" indicates a hazardous situation which, if not avoided, could result in serious injury or death.
	<b>CAUTION!</b> "CAUTION" indicates a hazardous situation which, if not avoided, could result in minor or moderate injury.
	<b>NOTE!</b> "NOTE" provides tips that are valuable for the optimal operation of your product.

## 2 Safety

### 2.1 Appropriate Usage

For safety reasons, installers are responsible for familiarizing themselves with the contents of this manual and all warnings before performing installation.

① Connect with T-BAT-SYS-HV-5.8

② Connect with T-BAT-SYS-HV-3.0

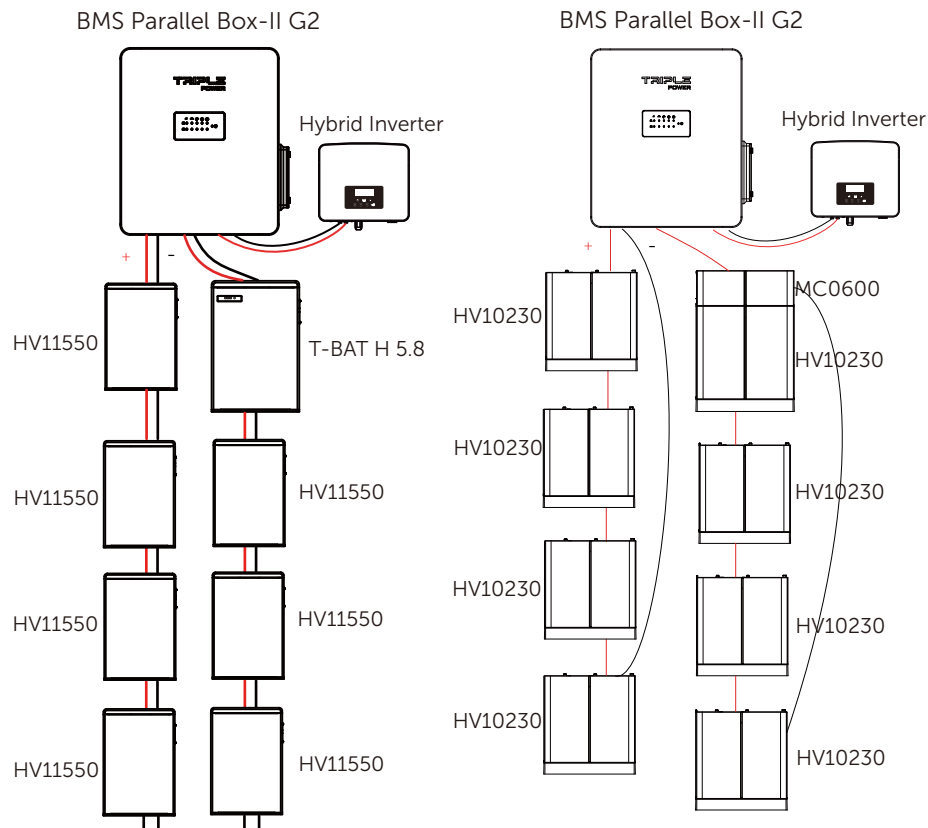

### 2.2 Important Safety Instructions

**DANGER!**

Danger to life due to high voltages in the parallel box!



- All work must be carried out by qualified electrician.
- The appliance is not to be used by children or persons with reduced physical sensory or mental capabilities, or lack of experience and knowledge, unless they have been given supervision or instruction.
- Children should be supervised to ensure that they do not play with the appliance.

**CAUTION!**

Danger of burn injuries due to hot enclosure parts!



- During operation, the upper lid of the enclosure and the enclosure body may become hot.
- Only touch the lower enclosure lid during operation.

**CAUTION!**

Possible damage to health as a result of the effects of radiation!



- Do not stay closer than 0.66 ft/20 cm to the parallel box for any length of time.

**WARNING !**

Do not operate the parallel box when the device is running.



**WARNING !**

Risk of electric shock!



**WARNING!**

- Authorized service personnel must disconnect the cables before attempting any maintenance or cleaning or working on any circuits connected to the box.



- Prior to the application, please read this section carefully to ensure correct and safe application.
- Please keep the user manual properly.
- Use only attachments recommended or sold by our company. Otherwise, it may result in a risk of fire, electric shock, or injury to person.
- Make sure that the existing wiring is in good condition and that the wire is not undersized.
- Do not disassemble any parts of the box which are not mentioned in the user manual. The parallel contains no user-serviceable parts.
- See Warranty for instructions on obtaining service. Attempting to service the box yourself may result in a risk of electric shock or fire and will void your warranty.
- Keep the parallel box away from flammable, explosive materials to avoid fire disaster.
- The installation place should be away from humid or corrosive substance.
- Authorized service personnel must use insulated tools when installing or working with this equipment.

## 2.3 Qualified Installer



### WARNING!

All operations of box relating to electrical connection and installation must be carried out by qualified personnel.

A skilled worker is defined as a trained and qualified electrician or installer who has all of the following skills and experience:

- Knowledge of the functional principles and operation of grid-tied systems
- Knowledge of the dangers and risks associated with installing and using electrical devices and acceptable mitigation methods
- Knowledge of the installation of electrical devices
- Knowledge of and adherence to this manual and all safety precautions and best practices

## 2.4 Explanation of Symbols

This section gives an explanation of all the symbols shown on the warning label.

Symbol	Explanation
	CE mark of conformity
	UKCA mark of conformity
	TUV certification
	The system must be disposed of at a proper facility for environmentally-safe recycling.
	Wear protective glasses.
	Read the enclosed documentation.
	Keep the battery system away from open flames or ignition sources.
	Keep the battery system away from children.
	Caution, risk of electric shock
	Caution, risk of danger

### 3 Product Introduction

#### 3.1 Product Overview

For safety reasons, installers are responsible for familiarizing themselves with the contents of this manual and all warnings before performing installation.

##### 3.1.1 Dimension

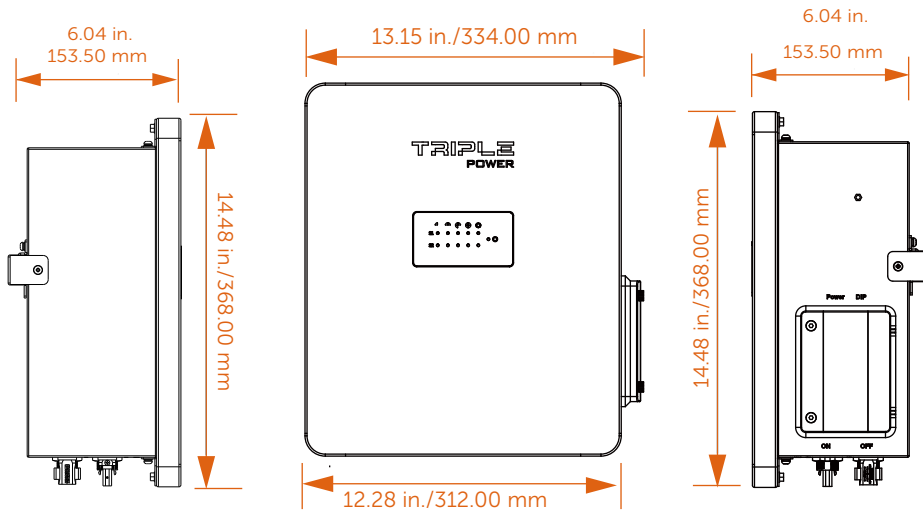

##### 3.1.2 Appearance

- Terminals of the BMS Parallel Box-II G2

Bottom view:

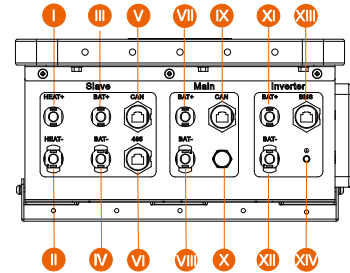

Right side view:

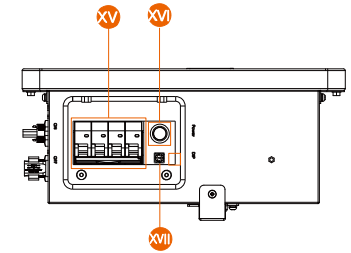

Object	Mark	Description
I	HEAT+	Connector Heat+ of the parallel box to Heat+ of Slave
II	HEAT-	Connector Heat- of the parallel box to Heat- of Slave
III	BAT+	Connector BAT+ of the parallel box to BAT+ of Slave
IV	BAT-	Connector BAT- of the parallel box to BAT- of Slave
V	CAN	Battery module communication of Slave
VI	485	Battery module communication of Slave
VII	BAT+	Connector BAT+ of the parallel box to BAT+ of Main
VIII	BAT-	Connector BAT+ of the parallel box to BAT+ of Main
IX	CAN	Battery module communication of Main
X	/	Air Venue
XI	BAT+	Connector BAT+ of the parallel Box to BAT+ of inverter
XII	BAT-	Connector BAT- of Box to BAT- of inverter
XIII	BMS	Connector BMS of Box to BMS of inverter
XIV	⊕	GND
XV	ON/OFF	Circuit Breaker
XVI	POWER	Power Button
XVII	DIP	DIP Switch

#### NOTE!

The cable connection between the parallel box and T58 is different from that between the parallel box and T30. Please refer to 4.5 and 4.6 from page 14 to 20 for details.



## 3.2 Basic Features

### 3.2.1 Features

The box has advanced technology, high reliability and convenient control functions, as shown below:

- Interact with inverter
- According to the interactive information, judge and control the running state of the battery system
- BMS related control processing
- Realize the corresponding fault identification and processing
- Ensure the safe operation of the battery system.
- Secondary protection by hardware
- IP65 protection level
- Safe and reliable
- Small occupied area
- Wall mounting

### 3.2.2 Certifications

Safety	IEC 62477-1, IEC 61439-1, IEC 61439-2
EMC	IEC 61000-6-1/2/3/4

## 3.3 Technical Data

Model	BMS Parallel Box-II G2
Dimension (W/H/D)(in/mm)	14.48*13.15*6.04/368*334*153.5
Dimension of Packing (W/H/D)(in/mm)	17.32*15.63*10.12/440*397*257
Net Weight (lbs/kg)	19.12/8.7
Recommend charge/discharge current [A]	25
Maximum Charge/Discharge Current (A)	35
Overvoltage Category (OVC)	II
Protective Class	I

Environment Requirement	
Input/Output voltage Range (V)	70-550
Environment	Outdoor
Standard Power (kW)	11.5
Maximum Power (kW)	16.1
Altitude (ft/m)	≤ 6561.68/2000
Pollution Degree	PD 3
Noise Level	<30dB
Operating Temperature	T-BAT-SYS-HV-3.0: -30°C~55°C (with heating function) -10°C~55°C (no heating function) T-BAT-SYS-HV-5.8: 0°C ~ 55°C (no heating function)
Ingress Protection	IP65

System one (T-BAT-SYS-HV-5.8)	Nominal voltage [V]	Operating voltage [V]	Total capacity [kWh]	Usable capacity [kWh]	Nominal power [kW]	Max power [kW]
T-BAT S 5.8 G2	115.2	110-131	5.8	5.1	2.8	4.0
T-BAT S 11.5 G2	230.4	200-262	11.5	10.3	5.7	8.0
T-BAT S 17.3 G2	345.6	300-393	17.3	15.5	8.6	12.0
T-BAT S 23.0 G2	460.8	400-524	23.0	20.7	11.5	16.1
T-BAT P 5.8 G2	115.2	100-131	11.5	10.3	2.8	4.0
T-BAT P 11.5 G2	230.4	200-262	23.0	20.7	5.7	8.0
T-BAT P 17.3 G2	345.6	300-393	34.6	31.1	8.6	12.0
T-BAT P 23.0 G2	460.8	400-524	46.1	41.4	11.5	16.1

System two (T-BAT-SYS-HV-3.0)	Nominal voltage [V]	Operating voltage [V]	Total capacity [kWh]	Usable capacity [kWh]	Nominal power [kW]	Max power [kW]
T-BAT S 3.0 G2	102.4	90-116	3.1	2.7	2.5	3.0
T-BAT S 6.0 G2	204.8	180-232	6.1	5.5	5.1	6.1
T-BAT S 9.0 G2	307.2	270-348	9.2	8.2	7.6	9.2
T-BAT S 12.0 G2	409.6	360-464	12.3	11.0	10.2	12.2
T-BAT P 3.0 G2	102.4	90-116	6.1	5.5	2.5	3.0
T-BAT P 6.0 G2	204.8	180-232	12.3	11.0	5.1	6.1
T-BAT P 9.0 G2	307.2	270-348	18.4	16.5	7.6	9.2
T-BAT P 12.0 G2	409.6	360-464	24.6	22.1	10.2	12.2

## 4 Installation

### 4.1 Installation Prerequisites

When assembling the system, avoid touching the terminal with any metal objects or bare hands. The box provides a safe source of electrical energy when operated as designed.

The previous safety precautions and the warning messages described in this section must be observed. If any of the previous precautions are not fully understood, or if you have any questions, contact customer service for guidance.

The Safety Section may not include all regulations for your region.

Ensure that the installation location meets the following conditions:

- The building is designed to withstand earthquakes
- The location is far from the sea to avoid salt water and humidity, over 0.62 miles/997.79 meters
- The floor is flat and level
- No inflammable or explosive materials within a range of at least 3 ft/0.91 m.
- The ambience is shady and cool, away from heat and direct sunlight
- The temperature and humidity remain at a constant level
- There is minimal dust and dirt in the area
- There are no corrosive gases present, including ammonia and acid vapor

In practice, the requirements of the parallel box installation may be different due to environment and locations. In that case, please follow up the exact requirements of the local laws and standards.

### 4.2 Safety Gear

Installation and maintenance personnel must operate according to applicable federal, state, and local regulations as well as industry standards regarding product installation. Personnel must wear safety gear as indicated below in order to avoid short circuit and personal injury.



Insulated Gloves



Safety Goggles



Safety Shoes

### 4.3 Tools

The following tools are required to install the box.



Torque Screw Driver



Phillips-Screw Driver



Hexagon Wrench



Phillips-Head Screw Driver



Flat-Head Screw Driver



Torque Wrench

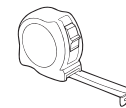

Tape Measure



Drill



Pencil or Marker

### 4.4 Installation

#### 4.4.1 Check for Transport Damage

Ensure the box is intact during and after transportation. If there are visible damages such as cracks, contact your supplier immediately.

#### 4.4.2 Unpacking

Unpack the box package by removing the packing tape. Ensure the box modules and relevant items are complete. See the package items on section 4.4.3 and check the packing list carefully. If there is any items missing, please contact our company or your distributor directly.



#### CAUTION!

According to regional regulations, it may require several people to move the equipment.



#### WARNING!

Please follow the installation steps strictly. Our company will not be responsible for any injuries or loss incurred by incorrect assembly and operation.

4.4.3 Accessories

① For use with T-BAT-SYS-HV-5.8

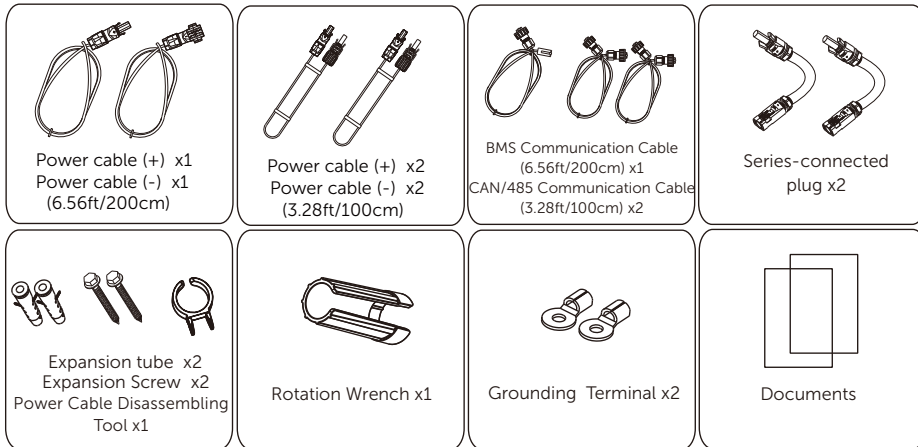

② For use with T-BAT-SYS-HV-3.0

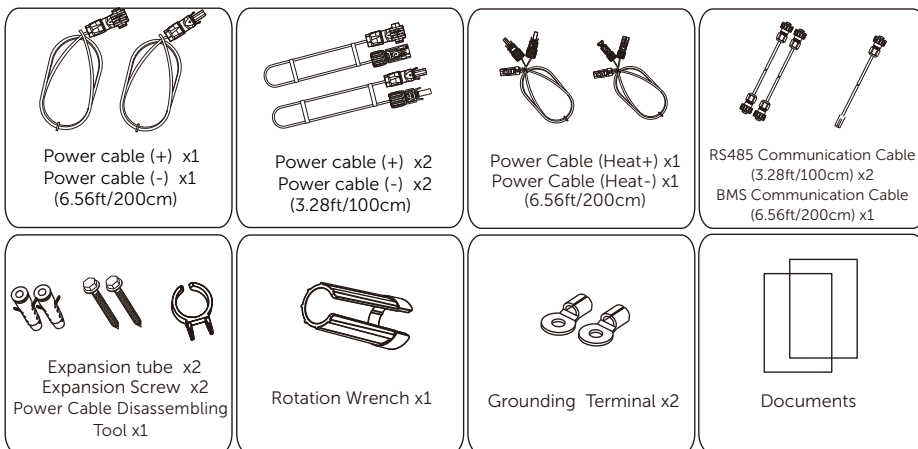

4.4.4 Mounting Steps

Wall Mounting:

Step 1: Fix the wall bracket on the wall

- The bracket needs to be removed from the box. Measure it and mark the position of the two holes. The bubble of the spirit level should be centered.
- Drill holes at the depth of at least 2.36 inches/60.00 mm by a drill.
- Install the expansion screw tubes on the wall, and screw the wall bracket by a torque wrench (Torque: 8-10 N·m)

Step 2: Match the box with the wall bracket

- Hang the box over the wall bracket, move the box close to it and match it on the wall bracket. Clip the buckle on the back of the box into the three slots of the back plate accurately. (Torque: 1.0-1.2 N·m)

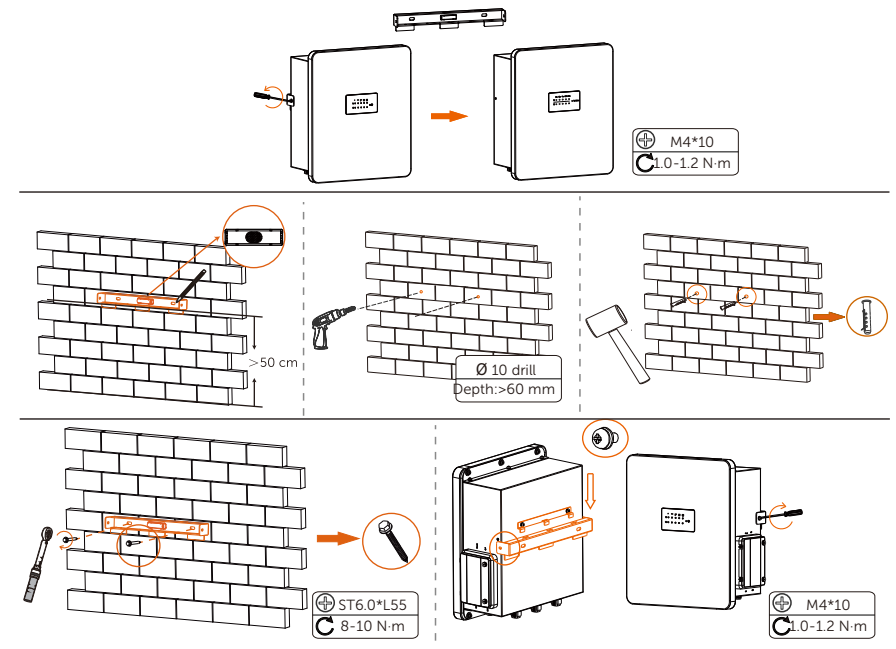

**CAUTION!**  
Ensure that the system is always exposed to ambient air. The system is cooled by natural convection. If the system is entirely or partially covered or shielded, it may cause the system to stop operating.

### 4.5 Overall Installation

Depending on the connection with different battery systems, there are two parallel options, with details as follows:

#### ① Connect with T-BAT-SYS-HV-5.8

Connect with a T-BAT H 5.8 (BMS) and a HV11550 battery module:

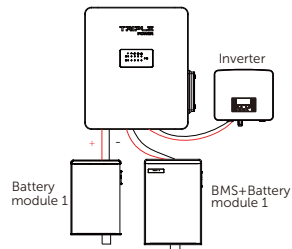

Connect with a T-BAT H 5.8 (BMS) and 3 HV11550 battery modules:

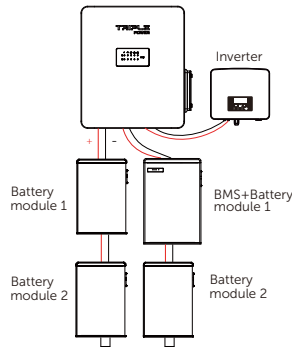

Connect with a T-BAT H 5.8 (BMS) and 5 HV11550 battery modules:

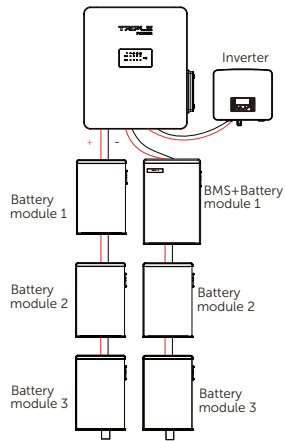

Connect with a T-BAT H 5.8 (BMS) and 7 HV11550 battery modules:

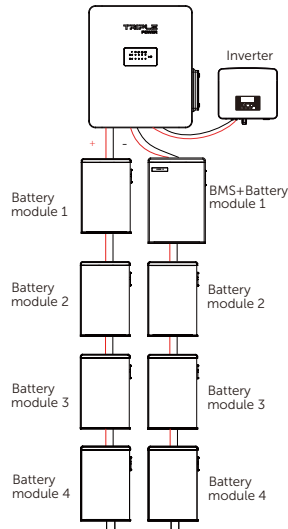

#### ② Connect with T-BAT-SYS-HV-3.0

Connect with a MC0600 (BMS) and 2 HV10230 battery modules:

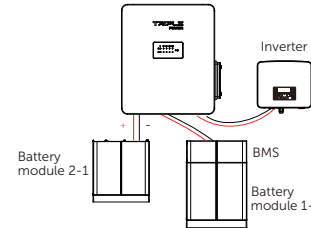

Connect with a MC0600 (BMS) and 4 HV10230 battery modules:

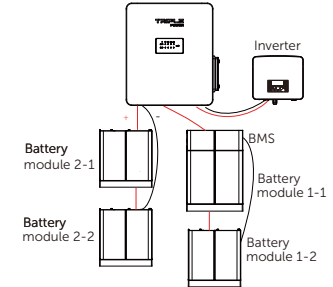

Connect with a MC0600 (BMS) and 6 HV10230 battery modules:

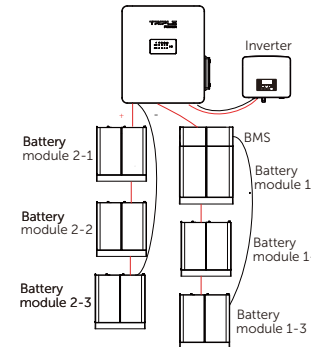

Connect with a MC0600 (BMS) and 8 HV10230 battery modules:

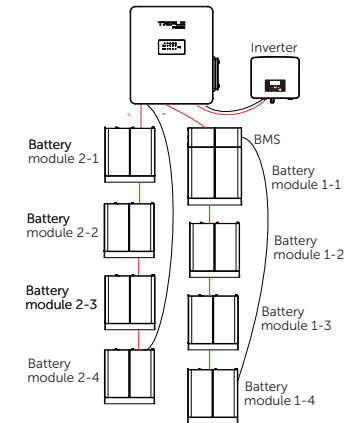

#### NOTE!

The recommended installation distance between the box and the battery group (including slave group and master group) is 11.81-23.62 inches /300-600 mm, and the distance between the modules is 9.84 inches/250.00 mm.

Before installation, please make sure that the wall can bear the weight of the batteries installed. If not, please take the mode of floor installation.

#### CAUTION!

It is not supported to connect only one master circuit without connecting the slave circuit. The number of modules connected at the master side and the slave side should be consistent. At most four modules can be connected at one side.

### 4.6 Cable Connection

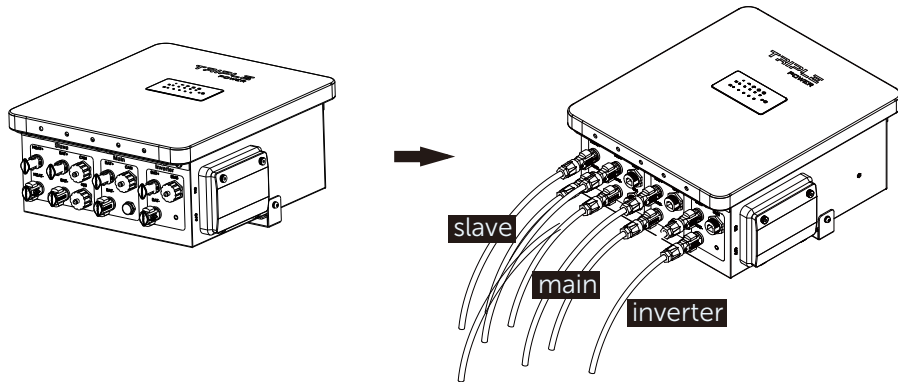

**NOTE!**

Remember to always keep the unused port plugged.

#### 4.6.1 Connecting Cables to Inverter

Cable connection from the parallel box to the inverter:

- "BAT+" to "BAT+";
- "BAT-" to "BAT-";
- "BMS" to "BMS".

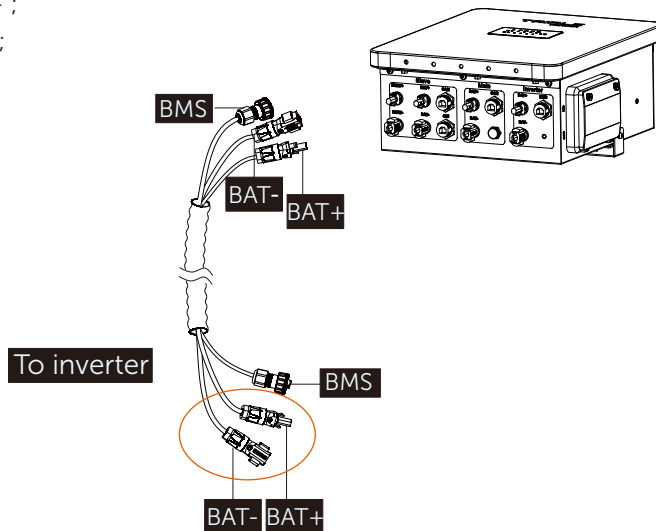

**NOTE!**

\*It is recommended to protect the cables by using corrugated pipe.

\*If you plug the cable into the wrong port, you can insert the power cable disassembling tool into the gap on the side of the joint to unplug the cable easily.

\* Please refer to "battery connection" section of the inverter's user manual/quick installation guide for details about inverter connection.

#### • Connecting the BMS Communication Cable

The wire order of the communication cable is as follows:

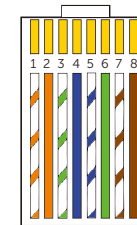
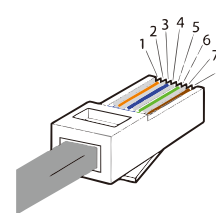

- 1) Orange stripes on white
- 2) Orange
- 3) Green stripes on white
- 4) Blue
- 5) Blue stripes on white
- 6) Green
- 7) Brown stripes on white
- 8) Brown

Sequence	1	2	3	4	5	6	7	8
BMS	/	GND	/	BMS_H	BMS_L	/	A1	B1

It is required for the BMS to communicate with the inverter for proper operation.

**NOTE!**

The BMS communication cable is shielded by aluminum foil.

4.6.2 Connecting Battery Modules

① For BMS Parallel box-II G2 + T-BAT H 5.8 + 1/3/5/7 HV11550 battery pack(s)

From BMS Parallel box-II G2 to T-BAT-SYS-HV-5.8:

Main "BAT+" to T-BAT H 5.8 "BAT+";

Main "BAT-" to T-BAT H 5.8 "BAT-".

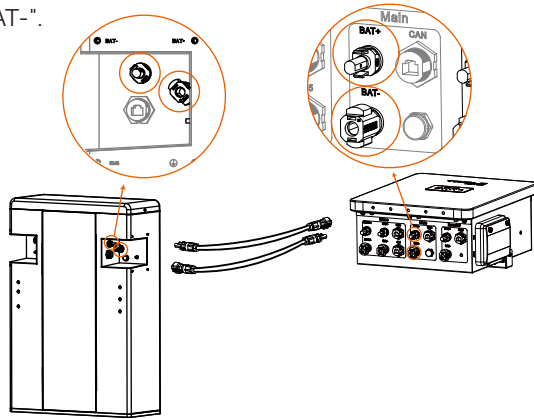

Slave "BAT+" to HV11550 "+";

Slave "BAT-" to HV11550 "XPLUG".

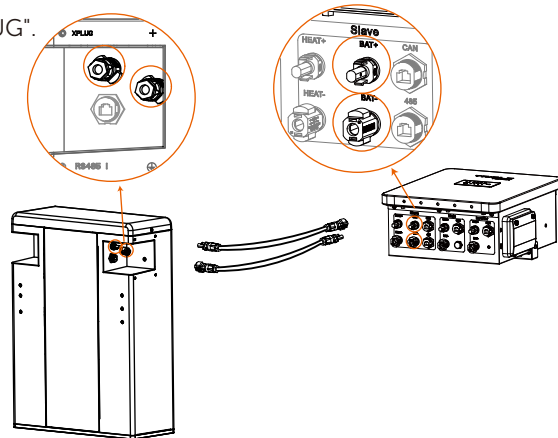

**NOTE!**

If there is(are) a port(s) that is(are) not wired after wiring is completed, please don't forget to put the waterproof cap(s) on the port(s). To form a complete circuit, connect "-" and "YPLUG" with series-connected cable on the right side of the last battery module. Please check T-BAT-SYS-HV-5.8 User Manual/Quick installation guide for detailed tutorial on cable-connecting between T-BAT H 5.8 and HV10230 battery modules.

② For BMS Parallel box-II G2 + MC0600 + 2/4/6/8 HV10230 battery modules

From BMS Parallel box-II G2 to T-BAT-SYS-HV-3.0:

Main "BAT+" to MC0600 "BAT+";

Main "BAT-" to MC0600 "BAT-".

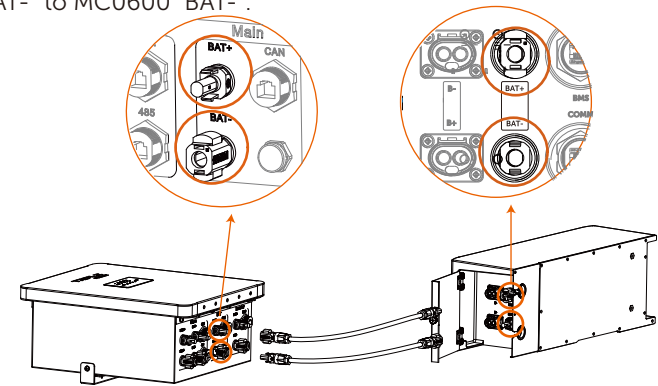

Slave "BAT+", Slave "Heat+" to HV10230 "B+";

Slave "BAT-", Slave "Heat-" to HV10230 "B-".

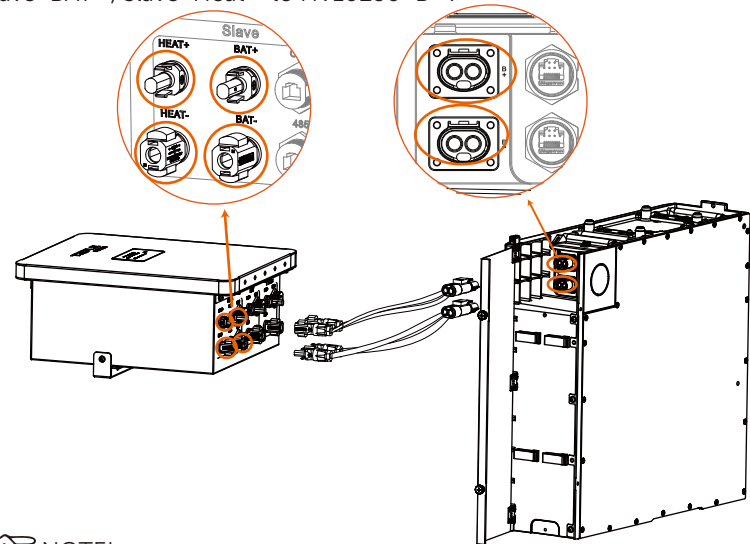

**NOTE!**

Regardless of how many battery modules installed, please put a waterproof cap on the communication port of the unconnected port of battery module. Please check T-BAT-SYS-HV-3.0 User Manual/Quick installation guide for detailed tutorial on cable-connecting between MC0600 and HV10230 battery modules.

### 4.6.3 Connecting Communication Cables

1) There is a protection cover for the RS485 connector. Unscrew the cover and plug one end of the RS485 I communication cable to the RS485 I connector. Tighten the plastic screw nut which is set on the cable with a rotation wrench. The operation is the same as above if connecting to the COMM/BMS connector.

For T-BAT-SYS-HV-5.8 (RS485 I, BMS):

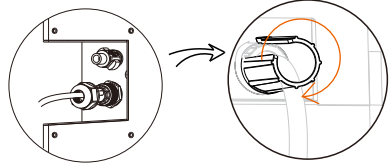

For T-BAT-SYS-HV-3.0 (COMM, BMS):

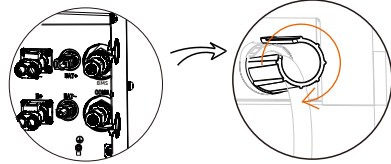

2) Connect the communication cable from the parallel box to the COMM/BMS/RS485 I communication port that is on the left side of the battery module.

HV11550 to Parallel box SLAVE "RS485 I";

HV10230 to Parallel box SLAVE "CAN";

T-BAT H 5.8 or MC0600 to Parallel box MAIN "CAN".

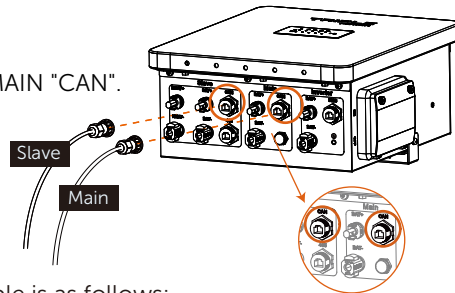

The wire order of the communication cable is as follows:

Sequence	1	2	3	4	5	6	7	8
SLAVE RS485 I	VCC_485	GND_485	B2	N-	P+	A2	VCC_485_2	GND_485
SLAVE CAN	VCC_1	GND	VCC_2	CANH	CANL	GND	N-	P+
MAIN CAN	/	GND	/	BMS_H	BMS_L	/	A1	B1

### 4.6.4 Connecting the Ground Wire

Remove the M5\*10 screw from the bottom of the BMS Parallel box-II G2 with a screwdriver, and then screw the ground wire(10 AWG/6 mm) to the corresponding grounding port.

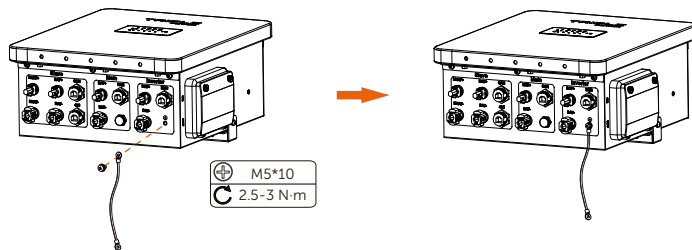

## 5 Commissioning

### 5.1 Configuring the Box

- The DIP switch is used to configure the communication between battery module(s) and the device. By default, only two groups of batteries can be matched for use.
- The black-start function is only used in an off-grid application and when there is no other power supply. To Black-start, hold down the button for 20 seconds until the soc light starts flashing green to indicate successful black-start. If the box is started in the black-start mode, remind that even when there is no BMS communication, the port still contains high voltage with risk of electric shock.  
If the BMS communication has still not been established within 3 minutes after starting the black-start mode, it indicates that the black start fails to start.
- After the BMS Parallel box-II G2 is powered on, if the indicator lights alternate flashing red and green for more than seven minutes, and then change to green flashing with the inverter reporting "Batt\_ClusterCommuCountMisMatch", please check the communication connection of the second group of BMS Parallel box-II G2, as well as the power-on status of T-BAT H 5.8 or MC0600 connected to the second group.
- After the BMS Parallel box-II G2 is powered on, if the indicator lights alternate flashing red and green for more than three minutes, and then change to flashing red for one second and off for three seconds, with the inverter reporting "BMS\_Internal\_Err 1", it indicates that the corresponding slave at position 1 failed to connect to the communication successfully. According to the error number, please check if the communication line of the slave at the corresponding position is properly connected.
- The BMS Parallel box-II G2 must be connected to two groups of batteries simultaneously in order to function properly, and the number of slaves in both groups must be the same. The second group of BMS Parallel box-II G2 must contain a T-BAT H 5.8 or Mc0600. And the two battery circuits connected to the BMS Parallel box-II G2 must be all HV11550 or all HV10230, and it is not allowed to connect one group with HV11550 batteries and the other group with HV10230 batteries.
- It is prohibited to plug or unplug the power line during the operation of the BMS Parallel box-II G2.

## 5.2 Commissioning

Verify the model number of each battery module to ensure that they are all the same model.

After all battery modules are installed, please follow the following steps to start the box:

- 1) Open the waterproof cover board of the box;
- 2) Move the circuit breaker switch to "ON";
- 3) Press the POWER button to start the box;
- 4) Reinstall the cover board to the box;
- 5) Turn on the inverter DC switch;
- 6) After starting the box, please confirm that the waterproof cover board is closed again.

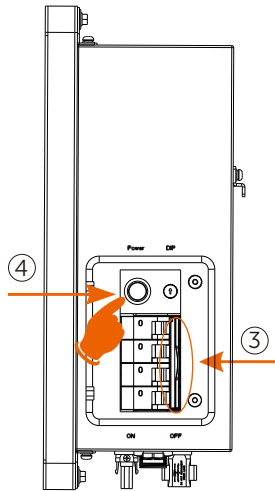

### NOTE!

Frequently pressing the POWER button may cause a system error. Allow at least 10 seconds after pressing the POWER button prior to making another attempt.

## 5.3 Status Indicators

The LED indicators on the front panel of the BMS and the battery modules indicate the operating status.

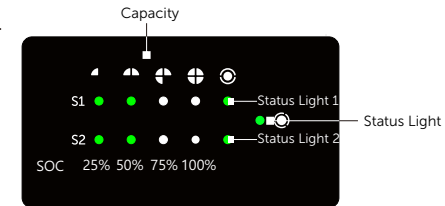

Description of the status indicators of BMS is shown as follows:

No.	Status of BMS	Mode
1	Green LED flashes on 1 sec and off for 4 sec	Inverter sends Idle command
2	(1) When both groups have faults, the status lights of the two groups will flash red at intervals of 0.5 seconds. The general status light will keep the red light on. (2) When one of the two groups has a fault, and the status light of one group flashes red (light for 1 second and off for 4 seconds), while the other group keeps the green light on. * When the fault is reported, the fault light of the corresponding branch will stay red.	Protection
3	The status light of one of the two groups is off if it works normally. The general status light will flash green (light for 1 second and off for 4 seconds) will stay on green light if an inverter is connected.	Normal
4	Green LED flashes once every 0.5 sec	Upgrade for BMS
5	Light off	Power off

The capacity indicators show the state of charge (SOC):

- When the battery module is neither charging nor discharging, the indicator lights are off.
- When the battery module is charging, a part of the blue LED flashes once every 5 seconds, and a part of the blue LED is on. Take SOC 60% for instance, when in charging state:
  - 1) The last two blue LED indicators are on
  - 2) The last three blue LED indicators flash once every 5 seconds
- When the battery module is discharging, the blue LED indicators flash once every 5 seconds. Take SOC 60% for instance, when in discharging state:
  - 1) The last three blue LED indicators flash once every 5 seconds



## 6 Troubleshooting

Check the indicators on the front to determine the state of the box.

A warning state is triggered when a condition, such as voltage or temperature, is beyond design limitations. Box periodically reports its operating state to the inverter.

When the box falls outside the prescribed limits, it enters into a warning state.

When a warning is reported, the inverter immediately stops its operation.

Use the monitoring software on the inverter to identify what caused the warning.

The possible warning messages are as follows:

Warning Messages	Description	Troubleshooting
BMS_Internal_Err	1) DIP switch on the wrong position 2) The communication between battery modules is interrupted.	1) Move the DIP switch to the correct position 2) Check if the communication cable between the battery modules is correctly and properly connected.
BMS_OverVoltage	Battery over voltage	Contact your distributor or our company directly for servicing.
BMS_LowerVoltage	Battery under voltage	Contact your distributor or our company directly for servicing.
BMS_ChargeOCP	Battery charge over current protection	Contact your distributor or our company directly for servicing.
BMS_DischargeOCP	Battery discharge over current protection	Contact your distributor or our company directly for servicing.

Warning Messages	Description	Troubleshooting
BMS_TemHigh	Battery over temperature	Wait until the temperature of the cells returns to the normal state.
BMS_TemLow	Battery under temperature	Wait until the temperature of the cells returns to the normal state.
BMS_CellImblance	The capacities of cells are different	Contact your distributor or our company directly for servicing.
BMS_Hardware_Protect	Battery hardware under protection	Contact your distributor or our company directly for servicing.
BMS_Insulation_Fault	Battery insulation fault	Contact your distributor or our company directly for servicing.
BMS_VoltSensor_Fault	Battery voltage sensor fault	Contact your distributor or our company directly for servicing.
BMS_TempSensor_Fault	Battery temperature sensor fault	Contact your distributor or our company directly for servicing.
BMS_CurrSensor_Fault	Battery current sensor fault	Contact your distributor or our company directly for servicing.
BMS_Relay_Fault	Battery relay fault	1) Ensure the power cable is correctly and properly connected to the power connector (XPLUG) of the BMS 2) If the first step still does not work, contact your distributor or our company directly.
BMS_Type_Unmatch	The type of BMS is unmatched	Contact your distributor or our company directly for servicing.
BMS_Ver_Unmatch	The version of BMS is unmatched	Contact your distributor or our company directly for servicing.

## 7 Decommissioning

### 7.1 Dismantling the Box

To shut down the system and dismantling the box, please follow the steps below:

- Turn off the breaker between the inverter and the box
- Power off BMS
- Turn off the system by moving the circuit breaker switch to the OFF position
- Ensure that every indicator on the box is off
- Disconnect the cables between the box and inverter
- Disconnect the series wiring terminal on the box
- Disconnect the cables

### 7.2 Packing

Pack the box in the original packaging.

If the original packaging is no longer available, use an equivalent carton or box that meets the following requirements:

- Suitable for loads over 154.32 lbs/69.94 kg
- Properly closed and sealed

## 8 Maintenance

- If the ambient temperature for storage is 86°F~122°F/30℃~50℃, recharge the batteries at least one time every 6 months.
- If the ambient temperature for storage is -4°F~-86°F /-20℃~30℃, recharge the batteries at least one time every 12 months.
- If the batteries have not been used for more than 9 months, these batteries must be charged to at least SOC 50 % each time.
- For the first installation, the interval among manufacture dates of battery modules shall not exceed 3 months.
- If a battery is replaced or added for capacity expansion, each battery's SOC should be consistent. The max. SOC difference should be between  $\pm 5\%$ .
- If users want to increase their battery system capacity, please ensure that the SOC of the existing system capacity is about 40%. The manufacture date of the new battery shall not exceed 6 months; in case of exceeding 6 months, please charge the new battery to around 40%.
- Maintain periodically  
Only qualified person may perform the following works.  
During the process of using the box, the manage person shall examine and maintain the machine regularly. The concrete operations are as follows.
  - 1) Check that if the cooling fans on the rear of house are covered by dirt, and the machine should be cleaned and absorbed dust when necessary.  
This work shall be check time to time.
  - 2) Check that if the indicators of the box are in normal state, check if the keys of the box are in normal state, check if the display of the system is normal.  
This check should be performed at least every 6 months.
  - 3) Check that if the input and output wires are damaged or aged. This check should be performed at least every 6 months.
  - 4) Check whether the ground terminal and ground cable are securely connected and all terminals and ports are properly sealed every 12 months.
  - 5) You should get the box panels cleaned and their security checked at least every 6 months.

## 9 Warranty

Triple Power protects this product under warranty when it is installed and used as listed in this manual.

Violation of the installation procedure or use of the product in any way not described in this manual will immediately void all warranties on the product.

Triple Power does not provide warranty coverage or assume any liability for direct or indirect damages or defects that result from the following causes:

- Force majeure (flooding, lightning strike, overvoltage, fire, thunderstorm, etc.)
- Improper or noncompliant use
- Improper installation, commissioning, start up or operation (contrary to the guidance detailed in the installation manual supplied with each product)
- Inadequate ventilation and circulation resulting in minimized cooling and natural air flow
- Installation in a corrosive environment
- Damage during transportation
- Unauthorized repair attempts
- Failure to adequately maintain the equipment. An on-site inspection by a qualified technician is possible following 120 months of continuous use.
- Warranty claims made beyond 120 months from date of commissioning may be declined if it cannot be demonstrated that the equipment has been adequately maintained.
- External influence including unusual physical or electrical stress (power failure surges, inrush current, etc.)
- Use of an incompatible inverter or devices
- Connect to other brands of inverter without authority from our company.

# Warranty Registration Form



### For Customer (Compulsory)

Name ..... Country .....

Phone Number ..... Email .....

Address .....

State ..... Zip Code .....

Product Serial Number .....

Date of Commissioning .....

Installation Company Name .....

Installer Name ..... Electrician License No. ....

### For Installer

#### Module ( If Any )

Module Brand .....

Module Size(W) .....

Number of String ..... Number of Panel Per String .....

#### Battery ( If Any )

Battery Type .....

Brand .....

Number of Battery Attached .....

Date of Delivery ..... Signature .....

Please visit our warranty website: <https://www.solaxcloud.com/#/warranty> to complete the online warranty registration or use your mobile phone to scan the QR code to register.

For more detailed warranty terms, please visit SolaX official website: [www.solaxpower.com](http://www.solaxpower.com) to check it.





PLEASE REGISTER THE WARRANTY IMMEDIATELY AFTER INSTALLATION!  
GET YOUR WARRANTY CERTIFICATE FROM SOLAX!  
KEEP YOUR INVERTER ONLINE & WIN SOLAX POINTS!

1

Open your camera app and point your device at the QR code



2

Wait for the camera to recognize the QR code



3

Click banner or notification when it appears on the screen



4

Warranty registration page will be loaded automatically

