

SERIES VRG130

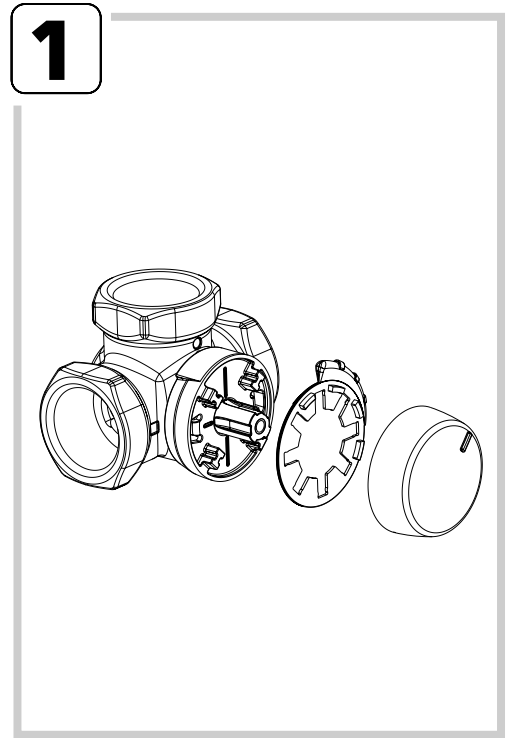

Series VRG131
 Series VRG132
 Series VRG133
 Series VRG138
 Series VRG139

Pressure Equipment Directive 97/23/EC

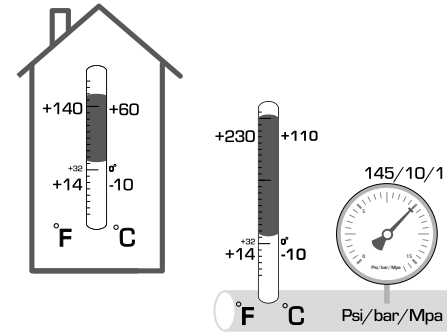

Mtrl.nr: 9814 02 69 • Ritn.nr: 7045 utg. D • Rev. 1401

i

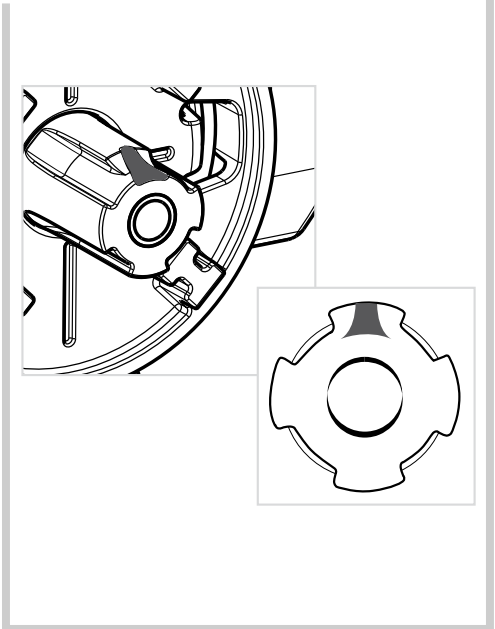

2

a

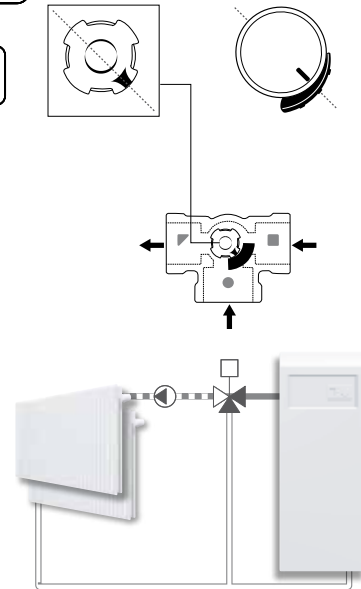

b

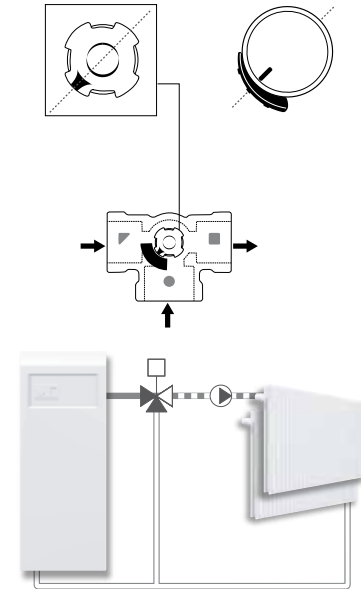

Piping Schematics are General Representations

3

a

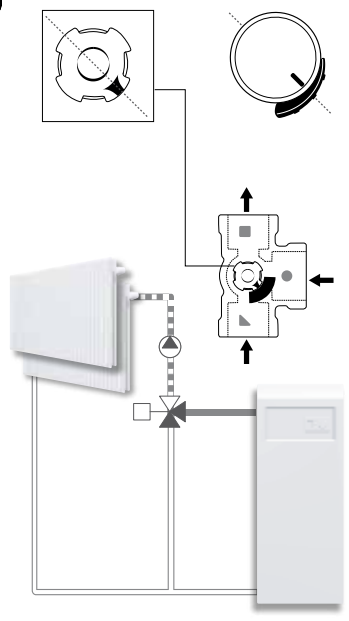

b

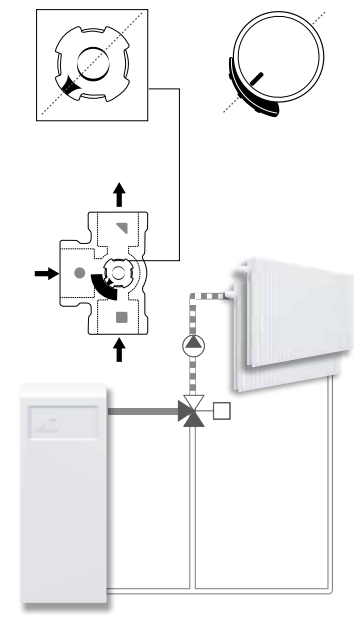

4

a

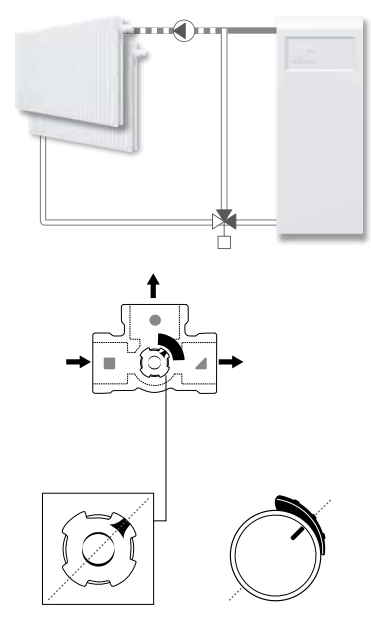

b

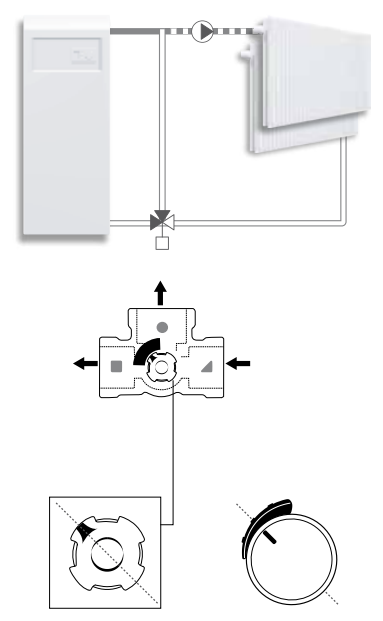

5

a

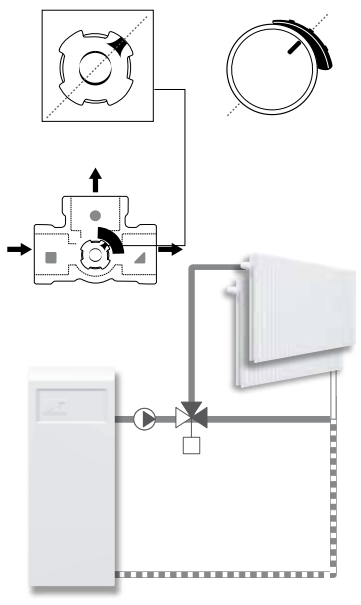

b

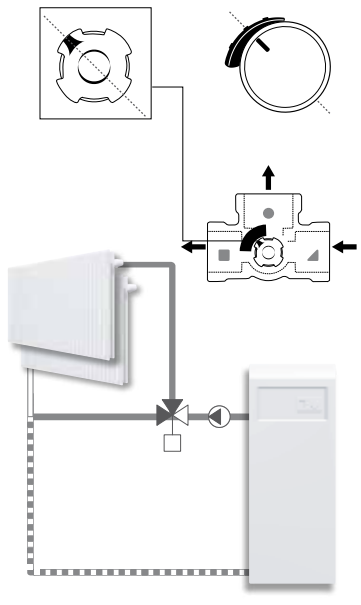

6

a

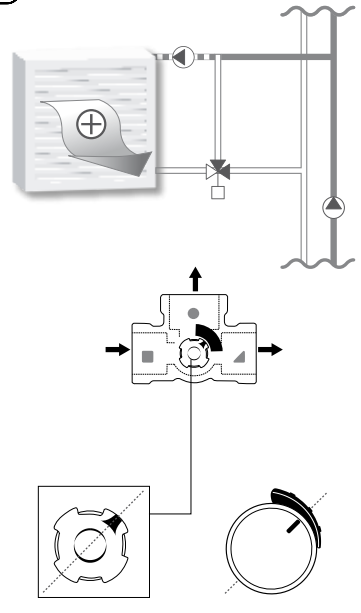

b

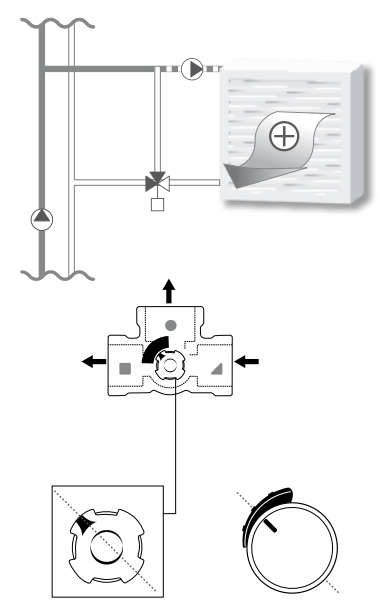

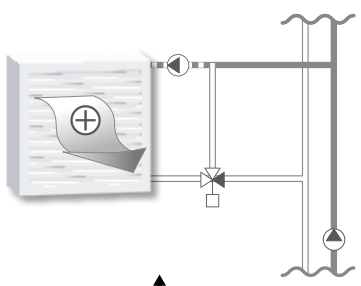
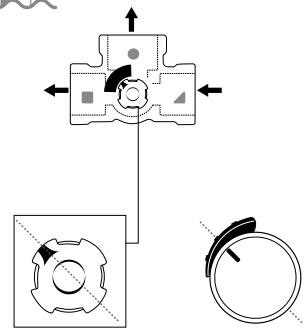
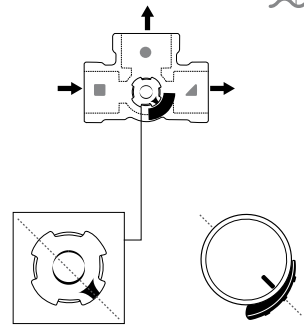
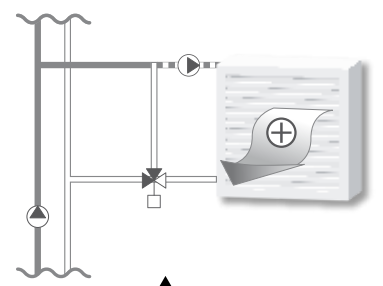
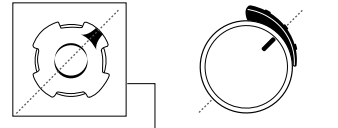
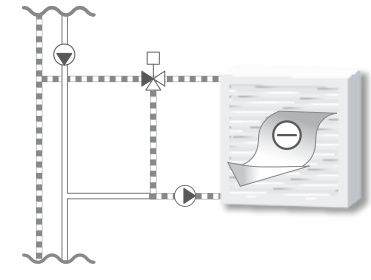
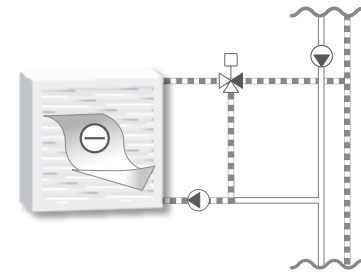
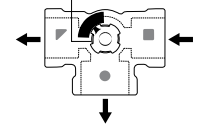
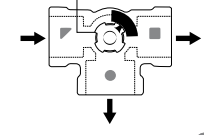
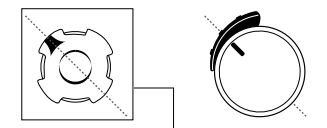
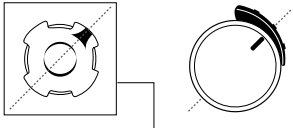
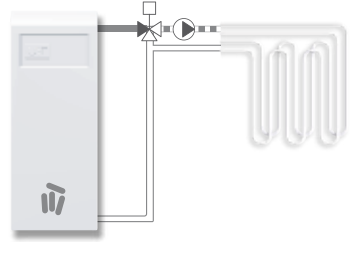
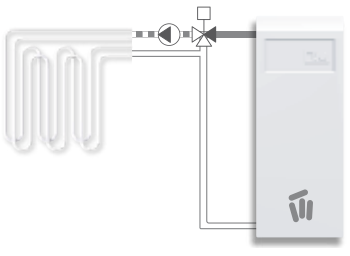
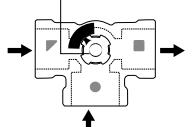
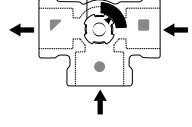
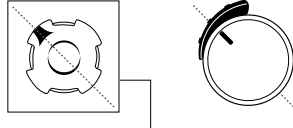
7**a****b****8****a****b****9****a****b****i****SE**

"Denna produkt är anpassad till Branschregler och Säker Vatteninstallation. Leverantören garanterar produktens funktion om branschreglerna och monteringsanvisningen följs."

